

**ANNEX 8**

**RESOLUTION MSC.556(108)  
(adopted on 23 May 2024)**

**AMENDMENTS TO THE  
INTERNATIONAL MARITIME DANGEROUS GOODS (IMDG) CODE**

THE MARITIME SAFETY COMMITTEE,

RECALLING Article 28(b) of the Convention on the International Maritime Organization concerning the functions of the Committee,

RECALLING ALSO resolution MSC.122(75) by which it adopted the International Maritime Dangerous Goods Code (hereinafter referred to as "the IMDG Code"), which has become mandatory under chapter VII of the International Convention for the Safety of Life at Sea (SOLAS), 1974, as amended (hereinafter referred to as "the Convention"),

RECALLING FURTHER article VIII(b) and regulation VII/1.1 of the Convention concerning the procedure for amending the IMDG Code,

HAVING CONSIDERED, at its 108th session, amendments to the IMDG Code, proposed and circulated in accordance with article VIII(b)(i) of the Convention,

1 ADOPTS, in accordance with article VIII(b)(iv) of the Convention, amendments to the IMDG Code, the text of which is set out in the annex to the present resolution;

2 DETERMINES, in accordance with article VIII(b)(vi)(2)(bb) of the Convention, that the said amendments shall be deemed to have been accepted on 1 July 2025, unless prior to that date more than one third of the Contracting Governments to the Convention or Contracting Governments the combined merchant fleets of which constitute not less than 50% of the gross tonnage of the world's merchant fleet, have notified their objections to the amendments;

3 INVITES Contracting Governments to the Convention to note that, in accordance with article VIII(b)(vii)(2) of the Convention, the amendments shall enter into force on 1 January 2026 upon their acceptance in accordance with paragraph 2 above;

4 AGREES that Contracting Governments to the Convention may apply the aforementioned amendments in whole or in part on a voluntary basis from 1 January 2025;

5 REQUESTS the Secretary-General, for the purposes of article VIII(b)(v) of the Convention, to transmit certified copies of the present resolution and the text of the amendments contained in the annexes to all Contracting Governments to the Convention;

6 ALSO REQUESTS the Secretary-General to transmit copies of this resolution and its annexes to Members of the Organization which are not Contracting Governments to the Convention.

ANNEX<sup>1</sup>

**AMENDMENTS TO THE INTERNATIONAL MARITIME  
DANGEROUS GOODS (IMDG) CODE  
AMENDMENT 42-24**

The complete text of the IMDG Code is replaced with the following:

---

<sup>1</sup> This annex is presented as follows:

- .1 appendix 1 contains parts 1 to 2 and 4 to 7 of the IMDG Code; and
- .2 appendix 2 contains part 3, appendices and index of the IMDG Code.

# Appendix 1

(parts 1-2 and 4-7)

## Contents

### PART 1 GENERAL PROVISIONS, DEFINITIONS AND TRAINING

|                    |   |    |
|--------------------|---|----|
| <b>Chapter 1.1</b> | <b>General provisions</b>   |    |
| 1.1.0              | Introductory note . . . . .   | 3  |
| 1.1.1              | Application and implementation of the Code . . . . .                  | 3  |
| 1.1.2              | Conventions . . . . .   | 4  |
| 1.1.3              | Dangerous goods forbidden from transport . . . . .                    | 12 |
| <b>Chapter 1.2</b> | <b>Definitions, units of measurement and abbreviations</b>            |    |
| 1.2.1              | Definitions . . . . .   | 13 |
| 1.2.2              | Units of measurement . . . . .  | 22 |
| 1.2.3              | List of abbreviations . . . . .                                       | 28 |
| <b>Chapter 1.3</b> | <b>Training</b>   |    |
| 1.3.0              | Introductory note . . . . .   | 30 |
| 1.3.1              | Training of shore-side personnel . . . . .                            | 30 |
| <b>Chapter 1.4</b> | <b>Security provisions</b>  |    |
| 1.4.0              | Scope . . . . .   | 35 |
| 1.4.1              | General provisions for companies, ships and port facilities . . . . . | 35 |
| 1.4.2              | General provisions for shore-side personnel . . . . .                 | 35 |
| 1.4.3              | Provisions for high consequence dangerous goods . . . . .             | 36 |
| <b>Chapter 1.5</b> | <b>General provisions concerning radioactive material</b>             |    |
| 1.5.1              | Scope and application . . . . .                                       | 39 |
| 1.5.2              | Radiation protection programme . . . . .                              | 40 |
| 1.5.3              | Management system . . . . .   | 40 |
| 1.5.4              | Special arrangement . . . . .   | 41 |
| 1.5.5              | Radioactive material possessing other dangerous properties . . . . .  | 41 |
| 1.5.6              | Non-compliance . . . . .  | 41 |

### PART 2 CLASSIFICATION

|                    |   |    |
|--------------------|---|----|
| <b>Chapter 2.0</b> | <b>Introduction</b>   |    |
| 2.0.0              | Responsibilities . . . . .  | 45 |
| 2.0.1              | Classes, divisions, packing groups . . . . .  | 45 |
| 2.0.2              | UN numbers and proper shipping names . . . . .  | 46 |
| 2.0.3              | Classification of substances, mixtures and solutions with multiple hazards (precedence of hazard characteristics) . . . . . | 48 |
| 2.0.4              | Transport of samples . . . . .  | 49 |
| 2.0.5              | Transport of wastes . . . . .   | 50 |
| 2.0.6              | Classification of articles as articles containing dangerous goods, N.O.S. . . . .   | 51 |
| <b>Chapter 2.1</b> | <b>Class 1 – Explosives</b>   |    |
| 2.1.0              | Introductory notes . . . . .  | 52 |

Contents

|                    |   |     |
|--------------------|---|-----|
| 2.1.1              | Definitions and general provisions . . . . .  | 52  |
| 2.1.2              | Compatibility groups and classification codes . . . . .   | 53  |
| 2.1.3              | Classification procedure . . . . .  | 55  |
| <b>Chapter 2.2</b> | <b>Class 2 – Gases</b>  |     |
| 2.2.0              | Introductory note . . . . .   | 62  |
| 2.2.1              | Definitions and general provisions . . . . .  | 62  |
| 2.2.2              | Class subdivisions . . . . .  | 62  |
| 2.2.3              | Mixtures of gases . . . . .   | 63  |
| 2.2.4              | Gases not accepted for transport . . . . .  | 64  |
| <b>Chapter 2.3</b> | <b>Class 3 – Flammable liquids</b>  |     |
| 2.3.0              | Introductory note . . . . .   | 65  |
| 2.3.1              | Definitions and general provisions . . . . .  | 65  |
| 2.3.2              | Assignment of packing group . . . . .   | 65  |
| 2.3.3              | Determination of flashpoint . . . . .   | 67  |
| 2.3.4              | Determination of initial boiling point . . . . .  | 68  |
| 2.3.5              | Substances not accepted for transport . . . . .   | 68  |
| <b>Chapter 2.4</b> | <b>Class 4 – Flammable solids; substances liable to spontaneous combustion; substances which, in contact with water, emit flammable gases</b> |     |
| 2.4.0              | Introductory note . . . . .   | 69  |
| 2.4.1              | Definition and general provisions . . . . .   | 69  |
| 2.4.2              | Class 4.1 – Flammable solids, self-reactive substances, solid desensitized explosives and polymerizing substances . . . . .                   | 69  |
| 2.4.3              | Class 4.2 – Substances liable to spontaneous combustion . . . . .   | 76  |
| 2.4.4              | Class 4.3 – Substances which, in contact with water, emit flammable gases . . . . .   | 77  |
| 2.4.5              | Classification of organometallic substances . . . . .   | 78  |
| <b>Chapter 2.5</b> | <b>Class 5 – Oxidizing substances and organic peroxides</b>   |     |
| 2.5.0              | Introductory note . . . . .   | 80  |
| 2.5.1              | Definitions and general provisions . . . . .  | 80  |
| 2.5.2              | Class 5.1 – Oxidizing substances . . . . .  | 80  |
| 2.5.3              | Class 5.2 – Organic peroxides . . . . .   | 82  |
| <b>Chapter 2.6</b> | <b>Class 6 – Toxic and infectious substances</b>  |     |
| 2.6.0              | Introductory notes . . . . .  | 96  |
| 2.6.1              | Definitions . . . . .   | 96  |
| 2.6.2              | Class 6.1 – Toxic substances . . . . .  | 96  |
| 2.6.3              | Class 6.2 – Infectious substances . . . . .   | 100 |
| <b>Chapter 2.7</b> | <b>Class 7 – Radioactive material</b>   |     |
| 2.7.1              | Definitions . . . . .   | 105 |
| 2.7.2              | Classification . . . . .  | 106 |
| <b>Chapter 2.8</b> | <b>Class 8 – Corrosive substances</b>   |     |
| 2.8.1              | Definition, general provisions and properties . . . . .   | 126 |
| 2.8.2              | General classification provisions . . . . .   | 127 |
| 2.8.3              | Packing group assignment for substances and mixtures . . . . .  | 127 |
| 2.8.4              | Alternative packing group assignment methods for mixtures: step-wise approach . . . . .   | 128 |
| 2.8.5              | Substances not accepted for transport . . . . .   | 131 |
| <b>Chapter 2.9</b> | <b>Miscellaneous dangerous substances and articles (class 9) and environmentally hazardous substances</b>                                     |     |
| 2.9.1              | Definition . . . . .  | 132 |
| 2.9.2              | Assignment to class 9 . . . . .   | 132 |

|                     |   |     |
|---------------------|---|-----|
| 2.9.3               | Environmentally hazardous substances (aquatic environment) . . . . .  | 135 |
| 2.9.4               | Lithium batteries . . . . .   | 144 |
| 2.9.5               | Sodium ion batteries . . . . .  | 145 |
| <b>Chapter 2.10</b> | <b>Marine pollutants</b>  |     |
| 2.10.1              | Definition . . . . .  | 146 |
| 2.10.2              | General provisions . . . . .  | 146 |
| 2.10.3              | Classification . . . . .  | 146 |
| <b>PART 3</b>       | <b>DANGEROUS GOODS LIST, SPECIAL PROVISIONS AND EXCEPTIONS</b>  |     |
|                     | <i>See Appendix 2 . . . . .</i>   | 564 |
| <b>PART 4</b>       | <b>PACKING AND TANK PROVISIONS</b>  |     |
| <b>Chapter 4.1</b>  | <b>Use of packagings, including intermediate bulk containers (IBCs) and large packagings</b>  |     |
| 4.1.0               | Definitions . . . . .   | 151 |
| 4.1.1               | General provisions for the packing of dangerous goods in packagings, including IBCs and large packagings . . . . .                            | 151 |
| 4.1.2               | Additional general provisions for the use of IBCs . . . . .   | 155 |
| 4.1.3               | General provisions concerning packing instructions . . . . .  | 155 |
| 4.1.4               | List of packing instructions . . . . .  | 159 |
|                     | <i>Packing instructions concerning the use of packagings (except IBCs and large packagings) . . . . .</i>                                     | 159 |
|                     | <i>Packing instructions concerning the use of IBCs . . . . .</i>  | 224 |
|                     | <i>Packing instructions concerning the use of large packagings . . . . .</i>  | 229 |
| 4.1.5               | Special packing provisions for goods of class 1 . . . . .   | 237 |
| 4.1.6               | Special packing provisions for goods of class 2 . . . . .   | 238 |
| 4.1.7               | Special packing provisions for organic peroxides (class 5.2) and self-reactive substances of class 4.1 . . . . .                              | 239 |
| 4.1.8               | Special packing provisions for infectious substances of category A (class 6.2, UN 2814 and UN 2900) . . . . .                                 | 240 |
| 4.1.9               | Special packing provisions for radioactive material . . . . .   | 241 |
| <b>Chapter 4.2</b>  | <b>Use of portable tanks and multiple-element gas containers (MEGCs)</b>  |     |
| 4.2.0               | Transitional provisions . . . . .   | 244 |
| 4.2.1               | General provisions for the use of portable tanks for the transport of substances of class 1 and classes 3 to 9 . . . . .                      | 245 |
| 4.2.2               | General provisions for the use of portable tanks for the transport of non-refrigerated liquefied gases and chemicals under pressure . . . . . | 248 |
| 4.2.3               | General provisions for the use of portable tanks for the transport of refrigerated liquefied gases of class 2 . . . . .                       | 249 |
| 4.2.4               | General provisions for the use of multiple-element gas containers (MEGCs)   | 250 |
| 4.2.5               | Portable tank instructions and special provisions . . . . .   | 251 |
|                     | <i>Portable tank instructions . . . . .</i>   | 252 |
|                     | <i>Portable tank special provisions . . . . .</i>   | 260 |
| 4.2.6               | Additional provisions for the use of road tank vehicles and road gas elements vehicles . . . . .  | 262 |
| <b>Chapter 4.3</b>  | <b>Use of bulk containers</b>   |     |
| 4.3.1               | General provisions . . . . .  | 263 |
| 4.3.2               | Additional provisions applicable to bulk goods of classes 4.2, 4.3, 5.1, 6.2, 7 and 8 . . . . .   | 264 |
| 4.3.3               | Additional provisions for the use of sheeted bulk containers (BK1) . . . . .  | 265 |
| 4.3.4               | Additional provisions for the use of flexible bulk containers (BK3) . . . . .   | 265 |

**PART 5 CONSIGNMENT PROCEDURES**

|                    |   |     |
|--------------------|---|-----|
| <b>Chapter 5.1</b> | <b>General provisions</b>   |     |
| 5.1.1              | Application and general provisions . . . . .  | 269 |
| 5.1.2              | Use of overpacks and unit loads. . . . .  | 269 |
| 5.1.3              | Empty uncleaned packagings or units . . . . .   | 270 |
| 5.1.4              | Mixed packing . . . . .   | 270 |
| 5.1.5              | General provisions for class 7. . . . .   | 270 |
| 5.1.6              | Packages packed into a cargo transport unit . . . . .   | 273 |
| <b>Chapter 5.2</b> | <b>Marking and labelling of packages including IBCs</b>   |     |
| 5.2.1              | Marking of packages including IBCs . . . . .  | 274 |
| 5.2.2              | Labelling of packages including IBCs. . . . .   | 277 |
| <b>Chapter 5.3</b> | <b>Placarding and marking of cargo transport units and bulk containers</b>  |     |
| 5.3.1              | Placarding . . . . .  | 288 |
| 5.3.2              | Marking . . . . .   | 290 |
| <b>Chapter 5.4</b> | <b>Documentation</b>  |     |
| 5.4.1              | Dangerous goods transport information . . . . .   | 292 |
| 5.4.2              | Container/vehicle packing certificate . . . . .   | 298 |
| 5.4.3              | Documentation required aboard the ship. . . . .   | 299 |
| 5.4.4              | Other required information and documentation. . . . .   | 299 |
| 5.4.5              | Multimodal Dangerous Goods Form . . . . .   | 299 |
| 5.4.6              | Retention of dangerous goods transport information . . . . .  | 303 |
| <b>Chapter 5.5</b> | <b>Special provisions</b>   |     |
| 5.5.1              | [Reserved] . . . . .  | 304 |
| 5.5.2              | Special provisions applicable to fumigated cargo transport units (UN 3359)  | 304 |
| 5.5.3              | Special provisions applicable to packages and cargo transport units containing substances presenting a risk of asphyxiation when used for cooling or conditioning purposes (such as dry ice (UN 1845) or nitrogen, refrigerated liquid (UN 1977) or argon, refrigerated liquid (UN 1951) or nitrogen) | 305 |
| 5.5.4              | Devices containing dangerous goods, which are in use or intended for use during transport . . . . .   | 308 |

**PART 6 CONSTRUCTION AND TESTING OF PACKAGINGS, INTERMEDIATE BULK CONTAINERS (IBCs), LARGE PACKAGINGS, PORTABLE TANKS, MULTIPLE-ELEMENT GAS CONTAINERS (MEGCs) AND ROAD TANK VEHICLES**

|                    |   |     |
|--------------------|---|-----|
| <b>Chapter 6.1</b> | <b>Provisions for the construction and testing of packagings</b>  |     |
| 6.1.1              | Applicability and general provisions. . . . .   | 311 |
| 6.1.2              | Code for designating types of packagings. . . . .   | 312 |
| 6.1.3              | Marking . . . . .   | 314 |
| 6.1.4              | Provisions for packagings. . . . .  | 317 |
| 6.1.5              | Test provisions for packagings. . . . .   | 324 |
| <b>Chapter 6.2</b> | <b>Provisions for the construction and testing of pressure receptacles, aerosol dispensers, small receptacles containing gas (gas cartridges) and fuel cell cartridges containing liquefied flammable gas</b> |     |
| 6.2.1              | General provisions . . . . .  | 330 |
| 6.2.2              | Provisions for UN pressure receptacles. . . . .   | 335 |
| 6.2.3              | Provisions for non-UN pressure receptacles . . . . .  | 352 |
| 6.2.4              | Provisions for aerosol dispensers, small receptacles containing gas (gas cartridges) and fuel cell cartridges containing liquefied flammable gas  | 353 |

|                    |  |     |
|--------------------|--|-----|
| <b>Chapter 6.3</b> | <b>Provisions for the construction and testing of packagings for class 6.2 infectious substances of category A (UN 2814 and UN 2900)</b>   |     |
| 6.3.1              | General  | 356 |
| 6.3.2              | Provisions for packagings  | 356 |
| 6.3.3              | Code for designating types of packagings   | 356 |
| 6.3.4              | Marking  | 356 |
| 6.3.5              | Test provisions for packagings   | 357 |
| <b>Chapter 6.4</b> | <b>Provisions for the construction, testing and approval of packages for radioactive material and for the approval of such material</b>    |     |
| 6.4.1              | [Reserved]   | 361 |
| 6.4.2              | General provisions   | 361 |
| 6.4.3              | Additional provisions for packages transported by air  | 362 |
| 6.4.4              | Provisions for excepted packages   | 362 |
| 6.4.5              | Provisions for industrial packages   | 362 |
| 6.4.6              | Provisions for packages containing uranium hexafluoride  | 363 |
| 6.4.7              | Provisions for Type A packages   | 363 |
| 6.4.8              | Provisions for Type B(U) packages  | 364 |
| 6.4.9              | Provisions for Type B(M) packages  | 366 |
| 6.4.10             | Provisions for Type C packages   | 366 |
| 6.4.11             | Provisions for packages containing fissile material  | 366 |
| 6.4.12             | Test procedures and demonstration of compliance  | 369 |
| 6.4.13             | Testing the integrity of the containment system and shielding and evaluating criticality safety  | 370 |
| 6.4.14             | Target for drop tests  | 370 |
| 6.4.15             | Test for demonstrating ability to withstand normal conditions of transport   | 370 |
| 6.4.16             | Additional tests for Type A packages designed for liquids and gases  | 371 |
| 6.4.17             | Tests for demonstrating ability to withstand accident conditions of transport  | 371 |
| 6.4.18             | Enhanced water immersion test for Type B(U) and Type B(M) packages containing more than 10 <sup>5</sup> A <sub>2</sub> and Type C packages | 372 |
| 6.4.19             | Water leakage test for packages containing fissile material  | 372 |
| 6.4.20             | Tests for Type C packages  | 372 |
| 6.4.21             | Tests for packagings designed to contain uranium hexafluoride  | 373 |
| 6.4.22             | Approvals of package designs and materials   | 373 |
| 6.4.23             | Applications for approval and approvals for radioactive material transport   | 373 |
| 6.4.24             | Transitional measures for class 7  | 380 |
| <b>Chapter 6.5</b> | <b>Provisions for the construction and testing of intermediate bulk containers (IBCs)</b>  |     |
| 6.5.1              | General requirements   | 382 |
| 6.5.2              | Marking  | 384 |
| 6.5.3              | Construction requirements  | 387 |
| 6.5.4              | Testing, certification and inspection  | 388 |
| 6.5.5              | Specific provisions for IBCs   | 389 |
| 6.5.6              | Test provisions for IBCs   | 394 |
| <b>Chapter 6.6</b> | <b>Provisions for the construction and testing of large packagings</b>   |     |
| 6.6.1              | General  | 402 |
| 6.6.2              | Code for designating types of large packagings   | 402 |
| 6.6.3              | Marking  | 402 |
| 6.6.4              | Specific provisions for large packagings   | 404 |
| 6.6.5              | Test provisions for large packagings   | 406 |



|                     |   |     |
|---------------------|---|-----|
| <b>Chapter 6.7</b>  | <b>Provisions for the design, construction, inspection and testing of portable tanks and multiple-element gas containers (MEGCs)</b>                                      |     |
| 6.7.1               | Application and general provisions . . . . .  | 410 |
| 6.7.2               | Provisions for the design, construction, inspection and testing of portable tanks intended for the transport of substances of class 1 and classes 3 to 9 . . . . .        | 410 |
| 6.7.3               | Provisions for the design, construction, inspection and testing of portable tanks intended for the transport of non-refrigerated liquefied gases of class 2 . . . . .     | 425 |
| 6.7.4               | Provisions for the design, construction, inspection and testing of portable tanks intended for the transport of refrigerated liquefied gases of class 2 . . . . .         | 436 |
| 6.7.5               | Provisions for the design, construction, inspection and testing of multiple-element gas containers (MEGCs) intended for the transport of non-refrigerated gases . . . . . | 446 |
| <b>Chapter 6.8</b>  | <b>Provisions for road tank vehicles and road gas elements vehicles</b>   |     |
| 6.8.1               | General . . . . .   | 453 |
| 6.8.2               | Road tank vehicles for long international voyages for substances of classes 3 to 9 . . . . .  | 453 |
| 6.8.3               | Road tank vehicles and road gas elements vehicles for short international voyages . . . . .   | 453 |
| <b>Chapter 6.9</b>  | <b>Provisions for the design, construction, inspection and testing of bulk containers</b>   |     |
| 6.9.1               | Definitions . . . . .   | 457 |
| 6.9.2               | Application and general provisions . . . . .  | 457 |
| 6.9.3               | Provisions for the design, construction, inspection and testing of freight containers used as BK1 or BK2 bulk containers . . . . .  | 457 |
| 6.9.4               | Provisions for the design, construction and approval of BK1 or BK2 bulk containers other than freight containers . . . . .  | 458 |
| 6.9.5               | Requirements for the design, construction, inspection and testing of flexible bulk containers BK3 . . . . .   | 459 |
| <b>Chapter 6.10</b> | <b>Provisions for the design, construction, inspection and testing of portable tanks with shells made of fibre-reinforced plastics (FRP) materials</b>                    |     |
| 6.10.1              | Application and general requirements . . . . .  | 463 |
| 6.10.2              | Provisions for the design, construction, inspection and testing of FRP portable tanks . . . . .   | 463 |
| <b>PART 7</b>       | <b>PROVISIONS CONCERNING TRANSPORT OPERATIONS</b>   |     |
| <b>Chapter 7.1</b>  | <b>General stowage provisions</b>   |     |
| 7.1.1               | Introduction . . . . .  | 475 |
| 7.1.2               | Definitions . . . . .   | 475 |
| 7.1.3               | Stowage categories . . . . .  | 476 |
| 7.1.4               | Special stowage provisions . . . . .  | 477 |
| 7.1.5               | Stowage codes . . . . .   | 482 |
| 7.1.6               | Handling codes . . . . .  | 483 |
| <b>Chapter 7.2</b>  | <b>General segregation provisions</b>   |     |
| 7.2.1               | Introduction . . . . .  | 484 |
| 7.2.2               | Definition . . . . .  | 484 |
| 7.2.3               | Segregation provisions . . . . .  | 484 |
| 7.2.4               | Segregation table . . . . .   | 485 |
| 7.2.5               | Segregation groups . . . . .  | 486 |

|                    |  |     |
|--------------------|--|-----|
| 7.2.6              | Special segregation provisions and exemptions . . . . .  | 486 |
| 7.2.7              | Segregation of goods of class 1 . . . . .  | 489 |
| 7.2.8              | Segregation codes . . . . .  | 490 |
|                    | <i>Annex: Segregation flow chart.</i> . . . . .  | 493 |
| <b>Chapter 7.3</b> | <b>Consigning operations concerning the packing and use of cargo transport units (CTUs) and related provisions</b> |     |
| 7.3.1              | Introduction . . . . .   | 495 |
| 7.3.2              | General provisions for cargo transport units . . . . .   | 495 |
| 7.3.3              | Packing of cargo transport units . . . . .   | 495 |
| 7.3.4              | Segregation provisions within cargo transport units . . . . .  | 496 |
| 7.3.5              | Tracking and monitoring equipment . . . . .  | 497 |
| 7.3.6              | Opening and unloading cargo transport units . . . . .  | 497 |
| 7.3.7              | Cargo transport units under temperature control . . . . .  | 497 |
| 7.3.8              | Loading of cargo transport units on board ships . . . . .  | 501 |
| <b>Chapter 7.4</b> | <b>Stowage and segregation on containerships</b>   |     |
| 7.4.1              | Introduction . . . . .   | 502 |
| 7.4.2              | Stowage requirements . . . . .   | 502 |
| 7.4.3              | Segregation requirements . . . . .   | 503 |
| <b>Chapter 7.5</b> | <b>Stowage and segregation on ro-ro ships</b>  |     |
| 7.5.1              | Introduction . . . . .   | 506 |
| 7.5.2              | Stowage provisions . . . . .   | 506 |
| 7.5.3              | Segregation provisions . . . . .   | 507 |
| <b>Chapter 7.6</b> | <b>Stowage and segregation on general cargo ships</b>  |     |
| 7.6.1              | Introduction . . . . .   | 508 |
| 7.6.2              | Stowage and handling provisions . . . . .  | 508 |
| 7.6.3              | Segregation provisions . . . . .   | 512 |
| <b>Chapter 7.7</b> | <b>Shipborne barges on barge-carrying ships</b>  |     |
| 7.7.1              | Introduction . . . . .   | 516 |
| 7.7.2              | Definitions . . . . .  | 516 |
| 7.7.3              | Barge loading . . . . .  | 516 |
| 7.7.4              | Stowage of shipborne barges . . . . .  | 517 |
| 7.7.5              | Segregation between barges on board barge-carrying ships . . . . .   | 517 |
| <b>Chapter 7.8</b> | <b>Special requirements in the event of an incident and fire precautions involving dangerous goods</b>             |     |
| 7.8.1              | General . . . . .  | 518 |
| 7.8.2              | General provisions in the event of incidents . . . . .   | 518 |
| 7.8.3              | Special provisions for incidents involving infectious substances . . . . .   | 518 |
| 7.8.4              | Special provisions for incidents involving radioactive material . . . . .  | 519 |
| 7.8.5              | General fire precautions . . . . .   | 519 |
| 7.8.6              | Special fire precautions for class 1 . . . . .   | 520 |
| 7.8.7              | Special fire precautions for class 2 . . . . .   | 520 |
| 7.8.8              | Special fire precautions for class 3 . . . . .   | 520 |
| 7.8.9              | Special fire precautions and fire fighting for class 7 . . . . .   | 520 |
| <b>Chapter 7.9</b> | <b>Exemptions, approvals and certificates</b>  |     |
| 7.9.1              | Exemptions . . . . .   | 521 |
| 7.9.2              | Approvals (including permits, authorizations or agreements) and certificates . . . . .                             | 521 |
| 7.9.3              | Contact information for the main designated national competent authorities . . . . .                               | 521 |

*Contents*

---

**APPENDICES**

**Appendix A** List of generic and N.O.S. proper shipping names

*See Appendix 2*

**Appendix B** Glossary of terms

*See Appendix 2*

**INDEX**

*See Appendix 2*



# **PART 1**

GENERAL PROVISIONS,  
DEFINITIONS AND TRAINING



# Chapter 1.1

## *General provisions*

### 1.1.0 Introductory note

It should be noted that other international and national modal regulations exist and that those regulations may recognize all or part of the provisions of this Code. In addition, port authorities and other bodies and organizations should recognize the Code and may use it as a basis for their storage and handling bye-laws within loading and discharge areas.

### 1.1.1 Application and implementation of the Code

1.1.1.1 The provisions contained in this Code are applicable to all ships to which the *International Convention for the Safety of Life at Sea, 1974* (SOLAS), as amended, applies and which are carrying dangerous goods as defined in regulation 1 of part A of chapter VII of that Convention.

1.1.1.2 The provisions of regulation II-2/19 of that Convention apply to passenger ships and to cargo ships constructed on or after 1 July 2002.

For:

- .1 a passenger ship constructed on or after 1 September 1984 but before 1 July 2002; or
- .2 a cargo ship of 500 gross tons or over constructed on or after 1 September 1984 but before 1 July 2002; or
- .3 a cargo ship of less than 500 gross tons constructed on or after 1 February 1992 but before 1 July 2002,

the requirements of regulation II-2/54 of SOLAS, as amended by resolutions MSC.1(XLV), MSC.6(48), MSC.13(57), MSC.22(59), MSC.24(60), MSC.27(61), MSC.31(63) and MSC.57(67), apply (see II-2/1.2).

For cargo ships of less than 500 gross tons constructed on or after 1 September 1984 and before 1 February 1992, it is recommended that Contracting Governments extend such application to these cargo ships as far as possible.

1.1.1.3 All ships, irrespective of type and size, carrying substances, materials or articles identified in this Code as marine pollutants are subject to the provisions of this Code.

1.1.1.4 In certain parts of this Code, a particular action is prescribed, but the responsibility for carrying out the action is not specifically assigned to any particular person. Such responsibility may vary according to the laws and customs of different countries and the international conventions into which these countries have entered. For the purpose of this Code, it is not necessary to make this assignment, but only to identify the action itself. It remains the prerogative of each Government to assign this responsibility.

1.1.1.5 Although this Code is legally treated as a mandatory instrument under chapter VII of SOLAS, as amended, the following provisions of the Code remain recommendatory:

- .1 paragraph 1.1.1.8 (Notification of infringements);
- .2 paragraphs 1.3.1.4 to 1.3.1.7 (Training);
- .3 chapter 1.4 (Security provisions) except 1.4.1.1, which is mandatory;
- .4 section 2.1.0 of chapter 2.1 (Class 1 – Explosives, Introductory notes);
- .5 section 2.3.3 of chapter 2.3 (Determination of flashpoint);
- .6 columns 15 and 17 of the Dangerous Goods List in chapter 3.2;
- .7 the segregation flow chart and example in the annex to chapter 7.2;
- .8 section 5.4.5 of chapter 5.4 (Multimodal Dangerous Goods Form), insofar as the layout of the form is concerned;

## 1 Part 1 – General provisions, definitions and training

- .9 chapter 7.8 (Special requirements in the event of an incident and fire precautions involving dangerous goods);
- .10 section 7.9.3 (Contact information for the main designated national competent authorities); and
- .11 appendix B.

### 1.1.1.6 Application of standards

Where the application of a standard is required and there is any conflict between the standard and the provisions of this Code, the provisions of this Code take precedence. The requirements of the standard that do not conflict with the provisions of this Code shall be applied as specified, including the requirements of any other standard, or part of a standard, referenced within that standard as normative.

- **Note:** A standard provides details on how to meet the provisions of this Code and may include requirements in addition to those set out in this Code.

### 1.1.1.7 Transport of dangerous goods used as a coolant or conditioner

Dangerous goods, that are only asphyxiant (which dilute or replace the oxygen normally in the atmosphere), when used in cargo transport units for cooling or conditioning purposes are only subject to the provisions of section 5.5.3.

**Note:** When carried on board as ship's stores or equipment, these coolants and conditioners are not subject to the provisions of this Code.

### 1.1.1.8 Notification of infringements

When a competent authority has reasons to believe that the safety of the transport of dangerous goods is compromised as a result of serious or repeated infringements of this Code by an enterprise which has its headquarters on the territory of another competent authority, it should if necessary notify that competent authority of such infringements.

### 1.1.1.9 Lamps containing dangerous goods

The following lamps are not subject to this Code provided that they do not contain radioactive material and do not contain mercury in quantities above those specified in special provision 366 of chapter 3.3:

- .1 lamps that are collected directly from individuals and households when transported to a collection or recycling facility;
- .2 lamps each containing not more than 1 g of dangerous goods and packaged so that there is not more than 30 g of dangerous goods per package, provided that:
  - (i) the lamps are manufactured according to a certified quality management system;
    - **Note:** The application of ISO 9001:2008 may be considered acceptable for this purpose.
  - and
  - (ii) each lamp is either individually packed in inner packagings, separated by dividers, or surrounded with cushioning material to protect the lamps and packed into strong outer packagings meeting the general provisions of 4.1.1.1 and capable of passing a 1.2 m drop test.
- .3 used, damaged or defective lamps each containing not more than 1 g of dangerous goods with not more than 30 g of dangerous goods per package when transported from a collection or recycling facility. The lamps shall be packed in strong outer packagings sufficient for preventing release of the contents under normal conditions of transport meeting the general provisions of 4.1.1.1 and that are capable of passing a drop test of not less than 1.2 m.
  - **Note:** Lamps containing radioactive material are addressed in 2.7.2.2.2.2.
- .4 lamps containing only gases of class 2.2 (according to 2.2.2.2) provided they are packaged so that the projectile effects of any rupture of the bulb will be contained within the package.

### △ 1.1.1.10 Devices containing dangerous goods, which are in use or intended for use during transport

- △ For devices containing dangerous goods, which are in use or intended for use during transport, see 5.5.4.

## 1.1.2 Conventions

### 1.1.2.1 International Convention for the Safety of Life at Sea, 1974

Part A of chapter VII of the International Convention for the Safety of Life at Sea, 1974 (SOLAS), as amended, deals with the carriage of dangerous goods in packaged form, and is reproduced in full:

## Chapter VII Carriage of dangerous goods

### Part A Carriage of dangerous goods in packaged form

#### Regulation 1 *Definitions*

For the purpose of this chapter, unless expressly provided otherwise:

- 1 *IMDG Code* means the International Maritime Dangerous Goods (IMDG) Code adopted by the Maritime Safety Committee of the Organization by resolution MSC.122(75), as may be amended by the Organization, provided that such amendments are adopted, brought into force and take effect in accordance with the provisions of article VIII of the present Convention concerning the amendment procedures applicable to the annex other than chapter I.
- 2 *Dangerous goods* mean the substances, materials and articles covered by the IMDG Code.
- 3 *Packaged form* means the form of containment specified in the IMDG Code.

#### Regulation 2 *Application*<sup>\*</sup>

- 1 Unless expressly provided otherwise, this part applies to the carriage of dangerous goods in packaged form in all ships to which the present regulations apply and in cargo ships of less than 500 gross tonnage.
- 2 The provisions of this part do not apply to ships' stores and equipment.
- 3 The carriage of dangerous goods in packaged form is prohibited except in accordance with the provisions of this chapter.
- 4 To supplement the provisions of this part, each Contracting Government shall issue, or cause to be issued, detailed instructions on emergency response and medical first aid relevant to incidents involving dangerous goods in packaged form, taking into account the guidelines developed by the Organization.<sup>†</sup>

#### Regulation 3 *Requirements for the carriage of dangerous goods*

The carriage of dangerous goods in packaged form shall be in compliance with the relevant provisions of the IMDG Code.

#### Regulation 4 *Documents*

- 1 Transport information relating to the carriage of dangerous goods in packaged form and the container/vehicle packing certificate shall be in accordance with the relevant provisions of the IMDG Code and shall be made available to the person or organization designated by the port State authority.
- 2 Each ship carrying dangerous goods in packaged form shall have a special list, manifest or stowage plan setting forth, in accordance with the relevant provisions of the IMDG Code, the dangerous goods on board and the location thereof. A copy of one of these documents shall be made available before departure to the person or organization designated by the port State authority.

<sup>\*</sup> Refer to:

- .1 part D which contains special requirements for the carriage of INF cargo; and
- .2 regulation II-2/19, which contains special requirements for ships carrying dangerous goods.

<sup>†</sup> Refer to:

- .1 the *Revised Emergency Response Procedures for Ships Carrying Dangerous Goods* (EmS Guide) (MSC.1/Circ.1588/Rev.2); and
- .2 the *Medical First Aid Guide for Use in Accidents Involving Dangerous Goods* (MFIAG).

These Guides are reproduced in the Supplement to the IMDG Code published by the Organization.



**Regulation 5***Cargo Securing Manual*

Cargo, cargo units\* and cargo transport units shall be loaded, stowed and secured throughout the voyage in accordance with the Cargo Securing Manual approved by the Administration. The Cargo Securing Manual shall be drawn up to a standard at least equivalent to the guidelines developed by the Organization.†

**Regulation 6***Reporting of incidents involving dangerous goods*

1 When an incident takes place involving the loss or likely loss overboard of dangerous goods in packaged form into the sea, the master, or other person having charge of the ship, shall report the particulars of such an incident without delay and to the fullest extent possible to the nearest coastal State. The report shall be drawn up based on general principles and guidelines developed by the Organization.‡

2 In the event of the ship referred to in paragraph 1 being abandoned, or in the event of a report from such a ship being incomplete or unobtainable, the company, as defined in regulation IX/1.2, shall, to the fullest extent possible, assume the obligations placed upon the master by this regulation.

**1.1.2.2 International Convention for the Prevention of Pollution from Ships (MARPOL)**

1.1.2.2.1 Annex III of the International Convention for the Prevention of Pollution from Ships, 1973, as modified by the Protocol of 1978 relating thereto (MARPOL), deals with the prevention of pollution by harmful substances carried by sea in packaged form and is reproduced in full, as revised by the Marine Environment Protection Committee.

**Annex III****Regulations for the prevention of pollution by harmful substances carried by sea in packaged form****Chapter 1 – General****Regulation 1***Definitions***Definitions**

1 For the purposes of this Annex:

*Harmful substances* are those substances which are identified as marine pollutants in the International Maritime Dangerous Goods Code (IMDG Code)§ or which meet the criteria in the appendix of this Annex.

2 *Packaged form* is defined as the forms of containment specified for harmful substances in the IMDG Code.

3 *Audit* means a systematic, independent and documented process for obtaining audit evidence and evaluating it objectively to determine the extent to which audit criteria are fulfilled.

4 *Audit Scheme* means the IMO Member State Audit Scheme established by the Organization and taking into account the guidelines developed by the Organization.¶

5 *Code for Implementation* means the IMO Instruments Implementation Code (III Code) adopted by the Organization by resolution A.1070(28).

6 *Audit Standard* means the Code for Implementation.

\* As defined in the *Code of Safe Practice for Cargo Stowage and Securing* (resolution A.714(17), as amended).

† Refer to *Revised guidelines for the preparation of the Cargo Securing Manual* (MSC.1/Circ.1353/Rev.2).

‡ Refer to *General principles for ship reporting systems and ship reporting requirements, including Guidelines for reporting incidents involving dangerous goods, harmful substances and/or marine pollutants* (resolution A.851(20), as amended).

§ Refer to the IMDG Code (resolution MSC.122(75), as amended).

¶ Refer to *Framework and Procedures for the IMO Member State Audit Scheme* (resolution A.1067(28)).

**Regulation 2***Application*

- 1 The carriage of harmful substances is prohibited, except in accordance with the provisions of this Annex.
- 2 To supplement the provisions of this Annex, the Government of each Party to the Convention shall issue, or cause to be issued, detailed requirements on packing, marking, labelling, documentation, stowage, quantity limitations and exceptions for preventing or minimizing pollution of the marine environment by harmful substances.
- 3 For the purposes of this Annex, empty packagings which have been used previously for the carriage of harmful substances shall themselves be treated as harmful substances unless adequate precautions have been taken to ensure that they contain no residue that is harmful to the marine environment.
- 4 The requirements of this Annex do not apply to ship's stores and equipment.

**Regulation 3***Packing*

Packages shall be adequate to minimize the hazard to the marine environment, having regard to their specific contents.

**Regulation 4***Marking and labelling*

- 1 Packages containing a harmful substance shall be durably marked or labelled to indicate that the substance is a harmful substance in accordance with the relevant provisions of the IMDG Code.
- 2 The method of affixing marks or labels on packages containing a harmful substance shall be in accordance with the relevant provisions of the IMDG Code.

**Regulation 5\****Documentation*

- 1 Transport information relating to the carriage of harmful substances shall be in accordance with the relevant provisions of the IMDG Code and shall be made available to the person or organization designated by the port State authority.
- 2 Each ship carrying harmful substances shall have a special list, manifest or stowage plan setting forth, in accordance with the relevant provisions of the IMDG Code, the harmful substances on board and the location thereof. A copy of one of these documents shall be made available before departure to the person or organization designated by the port State authority.

**Regulation 6***Stowage*

Harmful substances shall be properly stowed and secured so as to minimize the hazards to the marine environment without impairing the safety of the ship and persons on board.

**Regulation 7***Quantity limitations*

Certain harmful substances may, for sound scientific and technical reasons, need to be prohibited for carriage or be limited as to the quantity which may be carried aboard any one ship. In limiting the quantity, due consideration shall be given to size, construction and equipment of the ship, as well as the packaging and the inherent nature of the substances.

**Regulation 8***Exceptions*

- 1 Jettisoning of harmful substances carried in packaged form shall be prohibited, except where necessary for the purpose of securing the safety of the ship or saving life at sea.
- 2 Subject to the provisions of the present Convention, appropriate measures based on the physical, chemical and biological properties of harmful substances shall be taken to regulate the washing of leakages overboard, provided that compliance with such measures would not impair the safety of the ship and persons on board.

\* Reference to "documents" in this regulation does not preclude the use of electronic data processing (EDP) and electronic data interchange (EDI) transmission techniques as an aid to paper documentation.

**Regulation 9***Port State control on operational requirements\**

- 1 A ship when in a port or an offshore terminal of another Party is subject to inspection by officers duly authorized by such Party concerning operational requirements under this Annex.
- 2 Where there are clear grounds for believing that the master or crew are not familiar with essential shipboard procedures relating to the prevention of pollution by harmful substances, the Party shall take such steps, including carrying out detailed inspection and, if required, will ensure that the ship shall not sail until the situation has been brought to order in accordance with the requirements of this Annex.
- 3 Procedures relating to the port State control prescribed in article 5 of the present Convention shall apply to this regulation.
- 4 Nothing in this regulation shall be construed to limit the rights and obligations of a Party carrying out control over operational requirements specifically provided for in the present Convention.

**Chapter 2 – Verification of compliance with the provisions of this Annex****Regulation 10***Application*

Parties shall use the provisions of the Code for Implementation in the execution of their obligations and responsibilities contained in this Annex.

**Regulation 11***Verification of compliance*

- 1 Every Party shall be subject to periodic audits by the Organization in accordance with the audit standard to verify compliance with and implementation of this annex.
- 2 The Secretary-General of the Organization shall have responsibility for administering the Audit Scheme, based on the guidelines developed by the Organization.
- 3 Every Party shall have responsibility for facilitating the conduct of the audit and implementation of a programme of actions to address the findings, based on the guidelines developed by the Organization.<sup>†</sup>
- 4 Audit of all Parties shall be:
  - .1 based on an overall schedule developed by the Secretary-General of the Organization, taking into account the guidelines developed by the Organization; and
  - .2 conducted at periodic intervals, taking into account the guidelines developed by the Organization.

\* Refer to *Procedures for port State control, 2021* (resolution A.1155(32)).

<sup>†</sup> Refer to *Framework and Procedures for the IMO Member State Audit Scheme* (resolution A.1067(28)).

## Appendix to Annex III

### Criteria for the identification of harmful substances in packaged form

For the purpose of this Annex, substances, other than radioactive materials,<sup>\*</sup> identified by any one of the following criteria are harmful substances:<sup>†</sup>

#### (a) Acute (short-term) aquatic hazard

##### Category: Acute 1

|   |                 |
|---|-----------------|
| 96 hr LC <sub>50</sub> (for fish)                                 | ≤ 1 mg/L and/or |
| 48 hr EC <sub>50</sub> (for crustacea)                            | ≤ 1 mg/L and/or |
| 72 or 96 hr ErC <sub>50</sub> (for algae or other aquatic plants) | ≤ 1 mg/L        |

#### (b) Long-term aquatic hazard

(i) Non-rapidly degradable substances for which there are adequate chronic toxicity data available

##### Category: Chronic 1

|   |                   |
|---|-------------------|
| Chronic NOEC or EC <sub>x</sub> (for fish)                          | ≤ 0.1 mg/L and/or |
| Chronic NOEC or EC <sub>x</sub> (for crustacea)                     | ≤ 0.1 mg/L and/or |
| Chronic NOEC or EC <sub>x</sub> (for algae or other aquatic plants) | ≤ 0.1 mg/L        |

##### Category: Chronic 2

|   |                 |
|---|-----------------|
| Chronic NOEC or EC <sub>x</sub> (for fish)                          | ≤ 1 mg/L and/or |
| Chronic NOEC or EC <sub>x</sub> (for crustacea)                     | ≤ 1 mg/L and/or |
| Chronic NOEC or EC <sub>x</sub> (for algae or other aquatic plants) | ≤ 1 mg/L        |

(ii) Rapidly degradable substances for which there are adequate chronic toxicity data available

##### Category: Chronic 1

|   |                    |
|---|--------------------|
| Chronic NOEC or EC <sub>x</sub> (for fish)                          | ≤ 0.01 mg/L and/or |
| Chronic NOEC or EC <sub>x</sub> (for crustacea)                     | ≤ 0.01 mg/L and/or |
| Chronic NOEC or EC <sub>x</sub> (for algae or other aquatic plants) | ≤ 0.01 mg/L        |

##### Category: Chronic 2

|   |                   |
|---|-------------------|
| Chronic NOEC or EC <sub>x</sub> (for fish)                          | ≤ 0.1 mg/L and/or |
| Chronic NOEC or EC <sub>x</sub> (for crustacea)                     | ≤ 0.1 mg/L and/or |
| Chronic NOEC or EC <sub>x</sub> (for algae or other aquatic plants) | ≤ 0.1 mg/L        |

<sup>\*</sup> Refer to class 7, as defined in chapter 2.7 of the IMDG Code.

<sup>†</sup> The criteria are based on those developed by the United Nations Globally Harmonized System of Classification and Labelling of Chemicals (GHS), as amended. For definitions of acronyms or terms used in this appendix, refer to the relevant paragraphs of the IMDG Code.

1  
Part 1 – General provisions, definitions and training

(iii) Substances for which adequate chronic toxicity data are not available

**Category: Chronic 1**

|   |                 |
|---|-----------------|
| 96 hr LC <sub>50</sub> (for fish)                                 | ≤ 1 mg/L and/or |
| 48 hr EC <sub>50</sub> (for crustacea)                            | ≤ 1 mg/L and/or |
| 72 or 96 hr ErC <sub>50</sub> (for algae or other aquatic plants) | ≤ 1 mg/L        |

and the substance is not rapidly degradable and/or the experimentally determined BCF is ≥ 500 (or, if absent, the log K<sub>ow</sub> ≥ 4).

**Category: Chronic 2**

|   |                               |
|---|-------------------------------|
| 96 hr LC <sub>50</sub> (for fish)                                 | > 1 mg/L but ≤ 10 mg/L and/or |
| 48 hr EC <sub>50</sub> (for crustacea)                            | > 1 mg/L but ≤ 10 mg/L and/or |
| 72 or 96 hr ErC <sub>50</sub> (for algae or other aquatic plants) | > 1 mg/L but ≤ 10 mg/L        |

and the substance is not rapidly degradable and/or the experimentally determined BCF is ≥ 500 (or, if absent, the log K<sub>ow</sub> ≥ 4).

Additional guidance on the classification process for substances and mixtures is included in the IMDG Code.

1.1.2.3 **International Convention for Safe Containers, 1972 (CSC Convention), as amended**

1.1.2.3.1 Regulations 1 and 2 of annex I to the *International Convention for Safe Containers, 1972* (CSC Convention), as amended, deal with safety approval plates and maintenance and examination of containers, and are reproduced in full.

## Annex I

### Regulations for the testing, inspection, approval and maintenance of containers

#### Chapter I

##### *Regulations common to all systems of approval*

##### Regulation 1

##### *Safety Approval Plate*

- 1 (a) A Safety Approval Plate conforming to the specifications set out in the appendix to this annex shall be permanently affixed to every approved container at a readily visible place, adjacent to any other approval plate issued for official purposes, where it would not be easily damaged.
- (b) On each container, all maximum operating gross mass markings shall be consistent with the maximum operating gross mass information on the Safety Approval Plate.
- (c) The owner of the container shall remove the Safety Approval Plate on the container if:
  - (i) the container has been modified in a manner which would void the original approval and the information found on the Safety Approval Plate, or
  - (ii) the container is removed from service and is not being maintained in accordance with the Convention, or
  - (iii) the approval has been withdrawn by the Administration.
- 2 (a) The plate shall contain the following information in at least the English or French language:
 

**CSC SAFETY APPROVAL**

Country of approval and approval reference

Date (month and year) of manufacture

Manufacturer's identification number of the container or, in the case of existing containers for which that number is unknown, the number allotted by the Administration

Maximum operating gross mass (kg and lb)

Allowable stacking load for 1.8g (kg and lb)

Transverse racking test force (newtons).

- (b) A blank space should be reserved on the plate for insertion of end-wall and/or side-wall strength values (factors) in accordance with paragraph 3 of this regulation and annex II, tests 6 and 7. A blank space should also be reserved on the plate for the first and subsequent maintenance examination dates (month and year) when used.

3 Where the Administration considers that a new container satisfies the requirements of the present Convention in respect of safety and if, for such container, the end-wall and/or side-wall strength values (factors) are designed to be greater or less than those stipulated in annex II, such values shall be indicated on the Safety Approval Plate. Where the stacking or racking values are less than 192,000 kg or 150 kN, respectively, the container shall be considered as having limited stacking or racking capacity and shall be conspicuously marked, as required under the relevant standards,\* at or before their next scheduled examination or before any other date approved by the Administration, provided this is not later than 1 July 2015.

4 The presence of the Safety Approval Plate does not remove the necessity of displaying such labels or other information as may be required by other regulations which may be in force.

5 A container, the construction of which was completed prior to 1 July 2014, may retain the Safety Approval Plate as permitted by the Convention prior to that date as long as no structural modifications occur to that container.

## Regulation 2

### *Maintenance and examination*

- 1 The owner of the container shall be responsible for maintaining it in safe condition.
- 2 (a) The owner of an approved container shall examine the container or have it examined in accordance with the procedure either prescribed or approved by the Contracting Party concerned, at intervals appropriate to operating conditions.
- (b) The date (month and year) before which a new container shall undergo its first examination shall be marked on the Safety Approval Plate.
- (c) The date (month and year) before which the container shall be re-examined shall be clearly marked on the container on or as close as practicable to the Safety Approval Plate and in a manner acceptable to that Contracting Party which prescribed or approved the particular examination procedure involved.
- (d) The interval from the date of manufacture to the date of the first examination shall not exceed five years. Subsequent examination of new containers and re-examination of existing containers shall be at intervals of not more than 30 months. All examinations shall determine whether the container has any defects which could place any person in danger.
- 3 (a) As an alternative to paragraph 2, the Contracting Party concerned may approve a continuous examination programme if satisfied, on evidence submitted by the owner, that such a programme provides a standard of safety not inferior to the one set out in paragraph 2 above.
- (b) To indicate that the container is operated under an approved continuous examination programme, a mark showing the letters **ACEP** and the identification of the Contracting Party which has granted approval of the programme shall be displayed on the container on or as close as practicable to the Safety Approval Plate.
- (c) All examinations performed under such a programme shall determine whether a container has any defects which could place any person in danger. They shall be performed in connection with a major repair, refurbishment, or on-hire/off-hire interchange and in no case less than once every 30 months.
- 4 As a minimum, approved programmes should be reviewed once every 10 years to ensure their continued viability. In order to ensure uniformity by all involved in the inspection of containers and their ongoing operational safety, the Contracting Party concerned shall ensure the following elements are covered in each prescribed periodic or approved continuous examination programme:
- (a) methods, scope and criteria to be used during examinations;
- (b) frequency of examinations;
- (c) qualifications of personnel to carry out examinations;
- (d) system of keeping records and documents that will capture:
- (i) the owner's unique serial number of the container;
- (ii) the date on which the examination was carried out;
- (iii) identification of the competent person who carried out the examination;
- (iv) the name and location of the organization where the examination was carried out;

\* Refer to current standard ISO 6346, *Freight containers – Coding, identification and marking*.

## 1

### Part 1 – General provisions, definitions and training

---

- (v) the results of the examination; and
- (vi) in the case of a periodic examination scheme (PES), the next examination date (NED);
- (e) a system for recording and updating the identification numbers of all containers covered by the appropriate examination scheme;
- (f) methods and systems for maintenance criteria that addresses the design characteristics of the specific containers;
- (g) provisions for maintaining leased containers if different than those used for owned containers; and
- (h) conditions and procedures for adding containers into an already approved programme.

5 The Contracting Party shall carry out periodic audits of approved programmes to ensure compliance with the provisions approved by the Contracting Party. The Contracting Party shall withdraw any approval when the conditions of approval are no longer complied with.

6 For the purpose of this regulation, *the Contracting Party concerned* is the Contracting Party of the territory in which the owner is domiciled or has his head office. However, in the event that the owner is domiciled or has his head office in a country the government of which has not yet made arrangements for prescribing or approving an examination scheme and until such time as the arrangements have been made, the owner may use the procedure prescribed or approved by the Administration of a Contracting Party which is prepared to act as the Contracting Party concerned. The owner shall comply with the conditions for the use of such procedures set by the Administration in question.

7 Administrations shall make information on approved continuous examination programmes publicly available.

### 1.1.3 Dangerous goods forbidden from transport

1.1.3.1 Unless provided otherwise by this Code, the following are forbidden from transport:

Any substance or article which, as presented for transport, is liable to explode, dangerously react, produce a flame or dangerous evolution of heat or dangerous emission of toxic, corrosive or flammable gases or vapours under normal conditions of transport.

In chapter 3.3, special provisions 349, 350, 351, 352, 353 and 900 list certain substances, which are forbidden for transport.



## Chapter 1.2

### *Definitions, units of measurement and abbreviations*

#### 1.2.1 Definitions

The following is a list of definitions of general applicability that are used throughout this Code. Additional definitions of a highly specific nature are presented in the relevant chapters.

For the purposes of this Code:

*Aerosols or aerosol dispensers* means an article consisting of non-refillable receptacles meeting the provisions of 6.2.4, made of metal, glass or plastics and containing a gas compressed, liquefied or dissolved under pressure, with or without a liquid, paste or powder, and fitted with a release device allowing the contents to be ejected as solid or liquid particles in suspension in a gas, as a foam, paste or powder or in a liquid state or in a gaseous state.

*Alternative arrangement* means an approval granted by the competent authority for a portable tank or MEGC that has been designed, constructed or tested to technical requirements or testing methods other than those specified in this Code (see, for instance, 6.7.5.11.1).

*Animal material* means animal carcasses, animal body parts, foodstuffs or feedstuffs derived from animals.

*Approval*

*Multilateral approval*, for the transport of radioactive material, means approval by the relevant competent authority of the country of origin of the design or shipment, as applicable, and also, where the consignment is to be transported through or into any other country, approval by the competent authority of that country.

*Unilateral approval*, for the transport of radioactive material, means an approval of a design which is required to be given by the competent authority of the country of origin of the design only.

*Bags* means flexible packagings made of paper, plastic film, textiles, woven material, or other suitable materials.

*Barge-carrying ship* means a ship specially designed and equipped to transport shipborne barges.

*Barge feeder vessel* means a vessel specially designed and equipped to transport shipborne barges to or from a barge-carrying ship.

*Boxes* means packagings with complete rectangular or polygonal faces, made of metal, wood, plywood, reconstituted wood, fibreboard, plastics, or other suitable material. Small holes for purposes such as ease of the handling or opening of the box or to meet classification provisions are permitted as long as they do not compromise the integrity of the packaging during transport.

*Bulk containers* are containment systems (including any liner or coating) intended for the transport of solid substances which are in direct contact with the containment system. Packagings, intermediate bulk containers (IBCs), large packagings and portable tanks are not included.

Bulk containers:

- are of a permanent character and accordingly strong enough to be suitable for repeated use;
- are specially designed to facilitate the transport of goods by one or more means of transport without intermediate reloading;
- are fitted with devices permitting ready handling; and
- have a capacity of not less than 1 cubic metre.

Examples of bulk containers are freight containers, offshore bulk containers, skips, bulk bins, swap bodies, trough-shaped containers, roller containers, load compartments of vehicles or flexible bulk containers.

*Bundles of cylinders* are pressure receptacles comprising an assembly of cylinders or cylinder shells that are fastened together and which are interconnected by a manifold and transported as a unit. The total water



## 1 Part 1 – General provisions, definitions and training

capacity shall not exceed 3,000 L except that bundles intended for the transport of gases of class 2.3 shall be limited to 1,000 L water capacity.

*Cargo transport unit* means a road transport tank or freight vehicle, a railway transport tank or freight wagon, a multimodal freight container or portable tank, or an MEGC.

*Carrier* means any person, organization or Government undertaking the transport of dangerous goods by any means of transport. The term includes both carriers for hire or reward (known as *common* or *contract carriers* in some countries) and carriers on own account (known as *private carriers* in some countries).

*Cellular ship* means a ship in which containers are loaded under deck into specially designed slots giving a permanent stowage of the container during sea transport. Containers loaded on deck in such a ship are specially stacked and secured on fittings.

*Closed cargo transport unit*, with the exception of class 1, means a cargo transport unit which totally encloses the contents by permanent structures with complete and rigid surfaces. Cargo transport units with fabric sides or tops are not considered closed cargo transport units; for definition of closed cargo transport unit for class 1, see 7.1.2.

*Closed cryogenic receptacles* are thermally insulated pressure receptacles for refrigerated liquefied gases of a water capacity of not more than 1,000 L.

*Closed ro-ro cargo space* means a ro-ro cargo space which is neither an open ro-ro cargo space nor a weather deck.

*Closure* means a device which closes an opening in a receptacle.

**Note:** For pressure receptacles, closures are, for example, valves, pressure relief devices, pressure gauges or level indicators.

*Combination packagings* means a combination of packagings for transport purposes, consisting of one or more inner packagings secured in an outer packaging in accordance with 4.1.1.5.

*Competent authority* means any body or authority designated or otherwise recognized as such for any purpose in connection with this Code.

*Compliance assurance* means a systematic programme of measures applied by a competent authority which is aimed at ensuring that the provisions of this Code are met in practice.

*Composite packagings* means packagings consisting of an outer packaging and an inner receptacle so constructed that the inner receptacle and the outer packaging form an integral packaging. Once assembled, it remains thereafter an integrated single unit; it is filled, stored, transported and emptied as such.

*Confinement system*, for the transport of radioactive material, means the assembly of fissile material and packaging components specified by the designer and agreed to by the competent authority as intended to preserve criticality safety.

*Consignee* means any person, organization or Government which is entitled to take delivery of a consignment.

*Consignment* means any package or packages, or load of dangerous goods, presented by a consignor for transport.

*Consignor* means any person, organization or Government which prepares a consignment for transport.

*Containment system*, for the transport of radioactive material, means the assembly of components of the packaging specified by the designer as intended to retain the radioactive material during transport.

*Control temperature* means the maximum temperature at which certain substances (such as organic peroxides and self-reactive and related substances) can be safely transported during a prolonged period of time.

*Conveyance* means:

- .1 for transport by road or rail: any vehicle,
- .2 for transport by water: any ship, or any cargo space or defined deck area of a ship,
- .3 for transport by air: any aircraft.

*Crates* are outer packagings with incomplete surfaces.

*Criticality safety index (CSI) assigned to a package, overpack or freight container containing fissile material*, for the transport of radioactive material, means a number which is used to provide control over the accumulation of packages, overpacks or freight containers containing fissile material.

*Critical temperature* is the temperature above which the substance cannot exist in the liquid state.

*CTU Code* means the IMO/ILO/UNECE *Code of Practice for Packing of Cargo Transport Units (MSC.1/Circ.1497)*.\*

*Cylinders* are pressure receptacles of a water capacity not exceeding 150 L.

*Defined deck area* means the area, of the weather deck of a ship, or of a vehicle deck of a roll-on/roll-off ship, which is allocated for the stowage of dangerous goods.

- *Degree of filling* means the ratio, expressed in %, of the volume of liquid or solid introduced at 15°C into the means of containment and the volume of the means of containment ready for use.

*Design*, for the transport of radioactive material, means the description of fissile material excepted under 2.7.2.3.5.6, special form radioactive material, low dispersible radioactive material, package or packaging which enables such an item to be fully identified. The description may include specifications, engineering drawings, reports demonstrating compliance with regulatory requirements, and other relevant documentation.

*Design life*, for composite cylinders and tubes, means the maximum life (in number of years) to which the cylinder or tube is designed and approved in accordance with the applicable standard.

*Dose rate* means the ambient dose equivalent or the directional dose equivalent, as appropriate, per unit time, measured at the point of interest.

*Drums* means flat-ended or convex-ended cylindrical packagings made of metal, fibreboard, plastics, plywood or other suitable materials. This definition also includes packagings of other shapes, such as round taper-necked packagings, or pail-shaped packagings. Wooden barrels and jerricans are not covered by this definition.

*Elevated temperature substance* means a substance which is transported or offered for transport:

- in the liquid state at a temperature at or above 100°C
- in the liquid state with a flashpoint above 60°C that is intentionally heated to a temperature above its flashpoint; or
- in the solid state at a temperature at or above 240°C.

*Emergency temperature* means the temperature at which emergency procedures shall be implemented.

*Exclusive use*, for the transport of radioactive material, means the sole use, by a single consignor, of a conveyance or of a large freight container, in respect of which all initial, intermediate and final loading and unloading and shipment are carried out in accordance with the directions of the consignor or consignee, where so required by the provisions of this Code.

*Filling ratio* means the ratio of the mass of gas to the mass of water at 15°C that would fill completely a pressure receptacle fitted ready for use.

*Flashpoint* means the lowest temperature of a liquid at which its vapour forms an ignitable mixture with air.

*Foodstuff* includes foodstuffs, feeds or other edible substances intended for consumption by humans or animals.

*Freight container* means an article of transport equipment that is of a permanent character and accordingly strong enough to be suitable for repeated use; specially designed to facilitate the transport of goods, by one or more modes of transport, without intermediate reloading; designed to be secured and/or readily handled, having fittings for these purposes, and approved in accordance with the *International Convention for Safe Containers, 1972 (CSC Convention)*, as amended. In addition: *Small freight container* means a freight container that has an internal volume of not more than 3 m<sup>3</sup>. *Large freight container* means a freight container that has an internal volume of more than 3 m<sup>3</sup>.

For freight containers for the transport of radioactive material, a freight container may be used as a packaging. A small freight container is that which has either any overall outer dimension less than 1.5 m, or an internal volume of not more than 3 m<sup>3</sup>. Any other freight container is considered to be a large freight container.

*Fuel cell* means an electrochemical device that converts the chemical energy of a fuel to electrical energy, heat and reaction products.

*Fuel cell engine* means a device used to power equipment and which consists of a fuel cell and its fuel supply, whether integrated with or separate from the fuel cell, and includes all appurtenances necessary to fulfil its function.

\* Further practical guidance and background information related to the CTU Code are available as informative material (MSC.1/Circ.1498). The CTU Code and the Informative Material may be found at [www.unece.org/trans/wp24/guidelinespackingctus/intro.html](http://www.unece.org/trans/wp24/guidelinespackingctus/intro.html).

## 1 Part 1 – General provisions, definitions and training

*GHS* means the ninth revised edition of the *Globally Harmonized System of Classification and Labelling of Chemicals*, published by the United Nations as document ST/SG/AC.10/30/Rev.9.

*IAEA Regulations for the Safe Transport of Radioactive Material* means one of the editions of those Regulations, as follows:

- .1 for the 1985, 1985 (as amended 1990) editions: IAEA Safety Series No. 6;
- .2 for the 1996 edition: IAEA Safety Series No. ST-1;
- .3 for the 1996 (revised) edition: IAEA Safety Series No. TS-R-1 (ST-1, Revised);
- .4 for the 1996 (as amended 2003), 2005, 2009 editions: IAEA Safety Standards Series No. TS-R-1;
- .5 for the 2012 edition: IAEA Safety Standards Series No. SSR-6; and
- .6 for the 2018 edition: IAEA Safety Standards Series No. SSR-6 (Rev.1).

*IMO type 4 tank* means a road tank vehicle for the transport of dangerous goods of classes 3 to 9 and includes a semi-trailer with a permanently attached tank or a tank attached to a chassis, with at least four twist locks that take account of ISO standards (e.g. ISO 1161:1984).

*IMO type 6 tank* means a road tank vehicle for the transport of non-refrigerated liquefied gases of class 2 and includes a semi-trailer with a permanently attached tank or a tank attached to a chassis which is fitted with items of service equipment and structural equipment necessary for the transport of gases.

*IMO type 8 tank* means a road tank vehicle for the transport of refrigerated liquefied gases of class 2 and includes a semi-trailer with a permanently attached thermally insulated tank fitted with items of service equipment and structural equipment necessary for the transport of refrigerated liquefied gases.

*IMO type 9 tank* means a road gas elements vehicle for the transport of compressed gases of class 2 with elements linked to each other by a manifold, permanently attached to a chassis, which is fitted with items of service equipment and structural equipment necessary for the transport of gases. Elements are cylinders, tubes and bundles of cylinders, intended for the transport of gases as defined in 2.2.1.1.

*Inner packagings* means packagings for which an outer packaging is required for transport.

*Inner receptacles* means receptacles which require an outer packaging in order to perform their containment function.

*Inner vessel*, for a closed cryogenic receptacle, means the pressure vessel intended to contain the refrigerated liquefied gas.

*Inspection body* means an independent inspection and testing body approved by the competent authority.

*Intermediate bulk containers (IBCs)* means rigid or flexible portable packagings, other than specified in chapter 6.1, that:

- .1 have a capacity of:
  - .1 not more than 3.0 m<sup>3</sup> (3,000 L) for solids and liquids of packing groups II and III;
  - .2 not more than 1.5 m<sup>3</sup> for solids of packing group I when packed in flexible, rigid plastics, composite, fibreboard or wooden IBCs;
  - .3 not more than 3.0 m<sup>3</sup> for solids of packing group I when packed in metal IBCs;
  - .4 not more than 3.0 m<sup>3</sup> for radioactive material of class 7;
- .2 are designed for mechanical handling; and
- .3 are resistant to the stresses produced in handling and transport, as determined by tests.

*Remanufactured IBCs* are metal, rigid plastics or composite IBCs that:

- .1 are produced as a UN type from a non-UN type; or
- .2 are converted from one UN design type to another UN design type.

Remanufactured IBCs are subject to the same provisions of this Code that apply to new IBCs of the same type (see also design type definition in 6.5.6.1.1).

*Repaired IBCs* are metal, rigid plastics or composite IBCs that, as a result of impact or for any other cause (e.g. corrosion, embrittlement or other evidence of reduced strength as compared to the design type) are restored so as to conform to the design type and to be able to withstand the design type tests. For the purposes of this Code, the replacement of the rigid inner receptacle of a composite IBC with a receptacle conforming to the original design type from the same manufacturer is considered repair. However, routine maintenance of rigid IBCs (see definition below) is not considered repair. The bodies of rigid plastics IBCs and the inner receptacles of composite IBCs are not repairable. Flexible IBCs are not repairable, unless approved by the competent authority.

*Routine maintenance of flexible IBCs* is the routine performance on plastics or textile flexible IBCs of operations, such as:

- .1 cleaning; or
- .2 replacement of non-integral components, such as non-integral liners and closure ties, with components conforming to the original manufacturer's specification;

provided that these operations do not adversely affect the containment function of the flexible IBC or alter the design type.

**Note:** For rigid IBCs, see "Routine maintenance of rigid IBCs".

*Routine maintenance of rigid IBCs* is the routine performance on metal, rigid plastics or composite IBCs of operations such as:

- .1 cleaning;
- .2 removal and reinstallation or replacement of body closures (including associated gaskets), or of service equipment, conforming to the original manufacturer's specifications, provided that the leaktightness of the IBC is verified; or
- .3 restoration of structural equipment not directly performing a dangerous goods containment or discharge pressure retention function so as to conform to the design type (e.g. the straightening of legs or lifting attachments) provided that the containment function of the IBC is not affected.

**Note:** For flexible IBCs, see "Routine maintenance of flexible IBCs".

*Intermediate packagings* means packagings placed between inner packagings, or articles, and an outer packaging.

*Jerricans* means metal or plastics packagings of rectangular or polygonal cross-section.

*Large packagings* means packagings consisting of an outer packaging which contains articles or inner packagings and which:

- .1 are designed for mechanical handling; and
- .2 exceed 400 kg net mass or 450 L capacity but have a volume of not more than 3 m<sup>3</sup>.

*Large salvage packaging* means a special packaging which:

- .1 is designed for mechanical handling; and
- .2 exceeds 400 kg net mass or 450 L capacity but has a volume of not more than 3 m<sup>3</sup>;

into which damaged, defective, leaking or non-conforming dangerous goods packages, or dangerous goods that have spilled or leaked are placed for purposes of transport for recovery or disposal.

*Liner* means a separate tube or bag inserted into a packaging (including IBCs and large packagings) but not forming an integral part of it, including the closures of its openings.

*Liquids* are dangerous goods which at 50°C have a vapour pressure of not more than 300 kPa (3 bar), which are not completely gaseous at 20°C and at a pressure of 101.3 kPa, and which have a melting point or initial melting point of 20°C or less at a pressure of 101.3 kPa. A viscous substance for which a specific melting point cannot be determined shall be subjected to the ASTM D 4359-90 test; or to the test for determining fluidity (penetrometer test) prescribed in section 2.3.4 of Annex A of the Agreement concerning the *International Carriage of Dangerous Goods by Road (ADR)*.\*

*Long international voyage* means an international voyage that is not a short international voyage.

*Management system*, for the transport of radioactive material, means a set of interrelated or interacting elements (system) for establishing policies and objectives and enabling the objectives to be achieved in an efficient and effective manner.

*Manual of Tests and Criteria* means the seventh revised edition of the United Nations publication entitled *Manual of Tests and Criteria (ST/SG/AC.10/11/Rev.7 and Amend.1)*.

*Maximum capacity* as used in 6.1.4 means the maximum inner volume of receptacles or packagings expressed in litres.

*Maximum net mass* as used in 6.1.4 means the maximum net mass of contents in a single packaging or maximum combined mass of inner packagings and the contents thereof and is expressed in kilograms.

△ \* United Nations Publication: ECE/TRANS/326 (Sales No. E.22.VIII.2).

## 1 Part 1 – General provisions, definitions and training

*Maximum normal operating pressure*, for the transport of radioactive material, means the maximum pressure above atmospheric pressure at mean sea-level that would develop in the containment system in a period of one year under the conditions of temperature and solar radiation corresponding to environmental conditions in the absence of venting, external cooling by an ancillary system, or operational controls during transport.

*Metal hydride storage system* means a single complete hydrogen storage system, including a pressure receptacle shell, metal hydride, pressure relief device, shut-off valve, service equipment and internal components used for the transport of hydrogen only.

*Multiple-element gas containers* (MEGCs) are multimodal assemblies of cylinders, tubes or bundles of cylinders which are interconnected by a manifold and which are assembled within a framework. The MEGC includes service equipment and structural equipment necessary for the transport of gases.

*Net explosive mass* (NEM) means the total mass of the explosive substances, without the packagings, casings, etc. (*Net explosive quantity* (NEQ), *net explosive contents* (NEC), or *net explosive weight* (NEW) are often used to convey the same meaning.)

*Neutron radiation detector* is a device that detects neutron radiation. In such a device, a gas may be contained in a hermetically-sealed electron tube transducer that converts neutron radiation into a measurable electric signal.

*Offshore bulk container* means a bulk container specially designed for repeated use for the transport of dangerous goods to, from and between offshore facilities. An offshore bulk container is designed and constructed in accordance with *Guidelines for the approval of offshore containers handled in open seas* (MSC/Circ.860).

*Open cargo transport unit* means a unit which is not a closed cargo transport unit.

*Open cryogenic receptacle* means a transportable thermally insulated receptacle for refrigerated liquefied gases maintained at atmospheric pressure by continuous venting of the refrigerated liquefied gas.

*Open ro-ro cargo space* means a ro-ro cargo space either open at both ends, or open at one end and provided with adequate natural ventilation effective over its entire length through permanent openings in the side plating or deckhead to the satisfaction of the Administration.

*Outer packaging* means the outer protection of a composite or combination packaging together with any absorbent materials, cushioning and any other components necessary to contain and protect inner receptacles or inner packagings.

*Overpack* means an enclosure used by a single consignor to contain one or more packages and to form one unit for the convenience of handling and stowage during transport. Examples of overpacks are a number of packages either:

- .1 placed or stacked on to a load board, such as a pallet, and secured by strapping, shrink-wrapping, stretch-wrapping, or other suitable means; or
- .2 placed in a protective outer packaging such as a box or crate.

*Overstowed* means that a package or container is directly stowed on top of another.

*Package* means the complete product of the packing operation, consisting of the packaging and its contents prepared for transport.

*Packaging* means one or more receptacles and any other components or materials necessary for the receptacles to perform their containment and other safety functions.

*Pressure drums* are welded pressure receptacles of a water capacity exceeding 150 L and of not more than 1,000 L (e.g. cylindrical receptacles equipped with rolling hoops, spheres on skids).

*Pressure receptacles* are transportable receptacles intended for holding substances under pressure including its closure(s) and other service equipment and it is a collective term that includes cylinders, tubes, pressure drums, closed cryogenic receptacles, metal hydride storage systems, bundles of cylinders and salvage pressure receptacles.

*Pressure receptacle shell* means a cylinder, a tube, a pressure drum or a salvage pressure receptacle without its closures or other service equipment, but including any permanently attached device(s) (e.g. neck ring, foot ring, etc.).

**Note:** The terms “cylinder shell”, “pressure drum shell” and “tube shell” are also used.

*Quality assurance* means a systematic programme of controls and inspections applied by any organization or body which is aimed at providing adequate confidence that the standard of safety prescribed in this Code is achieved in practice.



*Radiation detection system* is an apparatus that contains radiation detectors as components.

*Radioactive contents*, for the transport of radioactive material, mean the radioactive material together with any contaminated or activated solids, liquids, and gases within the packaging.

*Receptacles* means containment vessels for receiving and holding substances or articles, including any means of closing.

*Reconditioned packagings* include:

- .1 metal drums that:
  - .1 are cleaned to original materials of construction, with all former contents, internal and external corrosion, and external coatings and labels removed;
  - .2 are restored to original shape and contour, with chimes (if any) straightened and sealed, and all non-integral gaskets replaced; and
  - .3 are inspected after cleaning, but before painting, with rejection of packagings with visible pitting, significant reduction in material thickness, metal fatigue, damaged threads or closures, or other significant defects;
- .2 plastic drums and jerricans that:
  - .1 are cleaned to original materials of construction, with all former contents, external coatings and labels removed;
  - .2 have all non-integral gaskets replaced; and
  - .3 are inspected after cleaning, with rejection of packagings with visible damage such as tears, creases or cracks, or damaged threads or closures, or other significant defects.

△ *Recycled plastics material* means material recovered from used industrial packagings or from other plastics material that has been pre-sorted and prepared for processing into new packagings, including IBCs. The specific properties of the recycled material used for production of new packagings, including IBCs, shall be assured and documented regularly as part of a quality assurance programme recognized by the competent authority. The quality assurance programme shall include a record of proper pre-sorting and verification that each batch of recycled plastics material, which is of homogeneous composition, is consistent with the material specifications (melt flow rate, density, and tensile properties) of the design type manufactured from such recycled material. This necessarily includes knowledge about the plastics material from which the recycled plastics have been derived, as well as awareness of the prior use, including prior contents, of the plastics material if that prior use might reduce the capability of new packagings, including IBCs, produced using that material. In addition, the packaging or IBC manufacturer's quality assurance programme under 6.1.1.3 or 6.5.4.1 shall include performance of the appropriate mechanical design type tests in 6.1.5 or 6.5.6 on packagings or IBCs, manufactured from each batch of recycled plastics material. In this testing, stacking performance may be verified by appropriate dynamic compression testing rather than static load testing.

△ **Note:** ISO 16103:2005, *Packaging – Transport packages for dangerous goods – Recycled plastics material*, provides additional guidance on procedures which may be followed in approving the use of recycled plastics material. These guidelines have been developed based on the experience of the manufacturing of drums and jerricans from recycled plastics material and as such may need to be adapted for other types of packagings, IBCs and large packagings made of recycled plastics material.

*Remanufactured IBCs* (see *Intermediate bulk containers* (IBCs)).

*Remanufactured large packaging* means a metal or rigid plastics large packaging that:

- .1 is produced as a UN type from a non-UN type; or
- .2 is converted from one UN design type to another UN design type.

Remanufactured large packagings are subject to the same provisions of this Code that apply to new large packagings of the same type (see also design type definition in 6.6.5.1.2).

*Remanufactured packagings* include:

- .1 metal drums that:
  - .1 are produced as a UN type from a non-UN type;
  - .2 are converted from one UN type to another UN type; or
  - .3 undergo the replacement of integral structural components (such as non-removable heads); or
- .2 plastic drums that:
  - .1 are converted from one UN type to another UN type (such as 1H1 to 1H2); or
  - .2 undergo the replacement of integral structural components.

Remanufactured drums are subject to the same provisions of this Code that apply to a new drum of the same type.

## 1 Part 1 – General provisions, definitions and training

---

*Repaired IBCs* (see *Intermediate bulk containers (IBCs)*).

*Re-used large packaging* means a large packaging to be refilled which has been examined and found free of defects affecting the ability to withstand the performance tests: the term includes those which are refilled with the same or similar compatible contents and are transported within distribution chains controlled by the consignor of the product.

*Re-used packagings* means packagings to be refilled which have been examined and found free of defects affecting the ability to withstand the performance tests; the term includes those which are refilled with the same or similar compatible contents and are transported within distribution chains controlled by the consignor of the product.

*Road tank vehicle* means a vehicle equipped with a tank with a capacity of more than 450 L, fitted with pressure-relief devices.

*Ro-ro cargo space* means spaces not normally subdivided in any way and extending to either a substantial length or the entire length of the ship in which goods (packaged or in bulk, in or on rail or road cars, vehicles (including road or rail tankers), trailers, containers, pallets, demountable tanks or in or on similar stowage units or other receptacles) can be loaded and unloaded normally in a horizontal direction.

*Ro-ro ship* (roll-on/roll-off ship) means a ship which has one or more decks, either closed or open, not normally subdivided in any way and generally running the entire length of the ship, carrying goods which are normally loaded and unloaded in a horizontal direction.

*Routine maintenance of IBCs* (see *Intermediate bulk containers (IBCs)*).

*Salvage packagings* are special packagings into which damaged, defective, leaking or non-conforming dangerous goods packages, or dangerous goods that have spilled or leaked, are placed for purposes of transport for recovery or disposal.

*Salvage pressure receptacle* means a pressure receptacle with a water capacity not exceeding 3,000 L into which are placed damaged, defective, leaking or non-conforming pressure receptacle(s) for the purpose of transport, e.g. for recovery or disposal.

*Self-accelerating decomposition temperature* (SADT) means the lowest temperature at which self-accelerating decomposition may occur in a substance in the packaging, IBC or portable tank as offered for transport. The SADT shall be determined in accordance with the test procedures given in Part II, Section 28 of the *Manual of Tests and Criteria*.

*Self-accelerating polymerization temperature* (SAPT) means the lowest temperature at which self-accelerating polymerization may occur with a substance in the packaging, IBC or portable tank as offered for transport. The SAPT shall be determined in accordance with the test procedures established for the self-accelerating decomposition temperature for self-reactive substances in accordance with part II, Section 28 of the *Manual of Tests and Criteria*.

*Semi-trailer* means any trailer designed to be coupled to a motor vehicle in such a way that part of it rests on the motor vehicle and a substantial part of its mass and of the mass of its load is borne by the motor vehicle.

*Service equipment* of a pressure receptacle means closure(s), manifold(s), piping, porous, absorbent or adsorbent material and any structural devices, e.g. for handling.

*Service life*, for composite cylinders and tubes, means the number of years the cylinder or tube is permitted to be in service.

*Settled pressure* means the pressure of the contents of a pressure receptacle in thermal and diffusive equilibrium.

*Shipborne barge* or *barge* means an independent, non-self-propelled vessel, specially designed and equipped to be lifted in a loaded condition and stowed aboard a barge-carrying ship or barge feeder vessel.

*Shipment* means the specific movement of a consignment from origin to destination.

*Shipper*, for the purpose of this Code, has the same meaning as *consignor*.

*Short international voyage* means an international voyage in the course of which a ship is not more than 200 miles from a port or place in which the passengers and crew could be placed in safety. Neither the distance between the last port of call in the country in which the voyage begins and the final port of destination nor the return voyage shall exceed 600 miles. The final port of destination is the last port of call in the scheduled voyage at which the ship commences its return voyage to the country in which the voyage began.

*Sift-proof packagings* are packagings impermeable to dry contents, including fine solid material produced during transport.

*Solid bulk cargo* means any material, other than liquid or gas, consisting of a combination of particles, granules or any larger pieces of material, generally uniform in composition, which is loaded directly into the cargo spaces of a ship without any intermediate form of containment (this includes a material loaded in a barge on a barge-carrying ship).

*Solids* are dangerous goods, other than gases, that do not meet the definition of *liquids* in this chapter.

*Special category space* means an enclosed space, above or below deck, intended for the transport of motor vehicles with fuel in their tanks for their own propulsion, into and from which such vehicles can be driven and to which passengers have access.

*Tank* means a portable tank (including a tank-container), a road tank-vehicle, a rail tank-wagon or a receptacle to contain solids, liquids, or liquefied gases and has a capacity of not less than 450 L when used for the transport of gases as defined in 2.2.1.1.

*Test pressure* means the required pressure applied during a pressure test for qualification or requalification (for portable tanks, see 6.7.2.1).

*Through or into* means through or into the countries in which a consignment is transported but specifically excludes countries “over” which a consignment is carried by air, provided that there are no scheduled stops in those countries.

*Transboundary movement of wastes* means any shipment of wastes from an area under the national jurisdiction of one country to or through an area under the national jurisdiction of another country, or to or through an area not under the national jurisdiction of any country, provided at least two countries are concerned by the movement.

*Transport index (TI)* assigned to a package, overpack or freight container, or to unpackaged LSA-I or SCO-I or SCO-III, for the transport of radioactive material, means a number which is used to provide control over radiation exposure.

*Tube* means a pressure receptacle of seamless or composite construction having a water capacity exceeding 150 L and of not more than 3,000 L.

*Unit load* means that a number of packages are either:

- .1 placed or stacked on and secured by strapping, shrink-wrapping, or other suitable means to a load board, such as a pallet;
- .2 placed in a protective outer enclosure, such as a pallet box;
- .3 permanently secured together in a sling.

*Vehicle* means a road vehicle (including an articulated vehicle, i.e. a tractor and semi-trailer combination) or railroad car or railway wagon. Each trailer shall be considered as a separate vehicle.

*Wastes* means substances, solutions, mixtures, or articles containing or contaminated with one or more constituents which are subject to the provisions of this Code and for which no direct use is envisaged but which are transported for dumping, incineration, or other methods of disposal.

*Water-reactive* means a substance which, in contact with water, emits flammable gas.

*Weather deck* means a deck which is completely exposed to the weather from above and from at least two sides.

*Wooden barrels* means packagings made of natural wood, of round cross-section, having convex walls, consisting of staves and heads and fitted with hoops.

*Working pressure:*

- .1 for a compressed gas, means the settled pressure at a reference temperature of 15°C in a full pressure receptacle;
- .2 for UN 1001 acetylene, dissolved, means the calculated settled pressure at a uniform reference temperature of 15°C in an acetylene cylinder containing the specified solvent content and the maximum acetylene content; and
- .3 for UN 3374 acetylene, solvent free, means the working pressure which was calculated for the equivalent cylinder for UN 1001 acetylene, dissolved.

#### 1.2.1.1 Clarifying examples for certain defined terms

The following explanations and examples are meant to assist in clarifying the use of some of the packaging terms defined in this chapter.



1  
**Part 1 – General provisions, definitions and training**

The definitions in this chapter are consistent with the use of the defined terms throughout the Code. However, some of the defined terms are commonly used in other ways. This is particularly evident in respect of the term “inner receptacle” which has often been used to describe the “inners” of a combination packaging.

The “inners” of “combination packagings” are always termed “inner packagings”, not “inner receptacles”. A glass bottle is an example of such an “inner packaging”.

The “inners” of “composite packagings” are normally termed “inner receptacles”. For example, the “inner” of a 6HA1 composite packaging (plastics material) is such an “inner receptacle” since it is normally not designed to perform a containment function without its “outer packaging” and is not, therefore, an “inner packaging”.

**1.2.2 Units of measurement**

1.2.2.1 The following units of measurement\* are applicable in this Code:

| Measurement of:                    | SI unit <sup>a</sup>          | Acceptable alternative unit              | Relationship between units   |
|------------------------------------|-------------------------------|--|--|
| Length                             | m (metre)                     | –  | –  |
| Area                               | m <sup>2</sup> (square metre) | –  | –  |
| Volume                             | m <sup>3</sup> (cubic metre)  | L <sup>b</sup> (litre)                   | 1 L = 10 <sup>-3</sup> m <sup>3</sup>  |
| Time                               | s (second)                    | min (minute)<br>h (hour)<br>d (day)      | 1 min = 60 s<br>1 h = 3,600 s<br>1 d = 86,400 s                              |
| Mass                               | kg (kilogram)                 | g (gram)<br>t (ton)                      | 1 g = 10 <sup>-3</sup> kg<br>1 t = 10 <sup>3</sup> kg                        |
| Mass density                       | kg/m <sup>3</sup>             | kg/L                                     | 1 kg/L = 10 <sup>3</sup> kg/m <sup>3</sup>                                   |
| Temperature                        | K (kelvin)                    | °C (degree Celsius)                      | 0°C = 273.15 K   |
| Difference of temperature          | K (kelvin)                    | °C (degree Celsius)                      | 1°C = 1 K  |
| Force                              | N (newton)                    | –  | 1 N = 1 kg·m/s <sup>2</sup>  |
| Pressure                           | Pa (pascal)                   | bar (bar)                                | 1 bar = 10 <sup>5</sup> Pa<br>1 Pa = 1 N/m <sup>2</sup>                      |
| Stress                             | N/m <sup>2</sup>              | N/mm <sup>2</sup>                        | 1 N/mm <sup>2</sup> = 1 MPa  |
| Work<br>Energy<br>Quantity of heat | J (joule)                     | kWh (kilowatt hour)<br>eV (electronvolt) | 1 kWh = 3.6 MJ<br>1 J = 1 N·m = 1 W·s<br>1 eV = 0.1602 × 10 <sup>-18</sup> J |
| Power                              | W (watt)                      | –  | 1 W = 1 J/s = 1 N·m/s  |
| Electrical resistance              | Ω (ohm)                       | –  | 1 Ω = 1 kg · m <sup>2</sup> · s <sup>-3</sup> · A <sup>-2</sup>              |
| Kinematic viscosity                | m <sup>2</sup> /s             | mm <sup>2</sup> /s                       | 1 mm <sup>2</sup> /s = 10 <sup>-6</sup> m <sup>2</sup> /s                    |
| Dynamic viscosity                  | Pa·s                          | mPa·s                                    | 1 mPa·s = 10 <sup>-3</sup> Pa·s  |
| Activity                           | Bq (becquerel)                | –  | –  |
| Dose equivalent                    | Sv (sievert)                  | –  | –  |
| Conductivity                       | S/m (siemens/metre)           | –  | –  |

<sup>a</sup> The International System of Units (SI) is the result of decisions taken at the General Conference on Weights and Measures (Address: Pavillon de Breteuil, Parc de St-Cloud, F-92312 Sèvres).

<sup>b</sup> The abbreviation “ℓ” for litre may also be used in place of the abbreviation “L”.

\* The following round figures are applicable for the conversion of the units hitherto used into SI units.

|   |  |   |                                 |
|---|--|---|---------------------------------|
| <b>Force</b>                                      |  | <b>Stress</b>                                     |                                 |
| 1 kg = 9.807 N                                    |  | 1 kg/mm <sup>2</sup> = 9.807 N/mm <sup>2</sup>    |                                 |
| 1 N = 0.102 kg                                    |  | 1 N/mm <sup>2</sup> = 0.102 kg/mm <sup>2</sup>    |                                 |
| <b>Pressure</b>                                   |  |   |                                 |
| 1 Pa = 1 N/m <sup>2</sup> = 10 <sup>-5</sup> bar  | = 1.02 × 10 <sup>-5</sup> kg/cm <sup>2</sup> | = 0.75 × 10 <sup>-2</sup> torr                    |                                 |
| 1 bar = 10 <sup>5</sup> Pa                        | = 1.02 kg/cm <sup>2</sup>                    | = 750 torr  |                                 |
| 1 kg/cm <sup>2</sup> = 9.807 × 10 <sup>4</sup> Pa | = 0.9807 bar                                 | = 736 torr  |                                 |
| 1 torr = 1.33 × 10 <sup>2</sup> Pa                | = 1.33 × 10 <sup>-3</sup> bar                | = 1.36 × 10 <sup>-3</sup> kg/cm <sup>2</sup>      |                                 |
| <b>Energy, work, quantity of heat</b>             |  |   |                                 |
| 1 J = 1 N·m                                       | = 0.278 × 10 <sup>-6</sup> kWh               | = 0.102 kg·m                                      | = 0.239 × 10 <sup>-3</sup> kcal |
| 1 kWh = 3.6 × 10 <sup>6</sup> J                   | = 367 × 10 <sup>3</sup> kg·m                 | = 860 kcal  |                                 |
| 1 kg·m = 9.807 J                                  | = 2.72 × 10 <sup>-6</sup> kWh                | = 2.34 × 10 <sup>-3</sup> kcal                    |                                 |
| 1 kcal = 4.19 × 10 <sup>3</sup> J                 | = 1.16 × 10 <sup>-3</sup> kWh                | = 427 kg·m  |                                 |
| <b>Power</b>                                      |  | <b>Kinematic viscosity</b>                        |                                 |
| 1 W = 0.102 kg·m/s                                | = 0.86 kcal/h                                | 1 m <sup>2</sup> /s = 10 <sup>4</sup> St (stokes) |                                 |
| 1 kg·m/s = 9.807 W                                | = 8.43 kcal/h                                | 1 St = 10 <sup>-4</sup> m <sup>2</sup> /s         |                                 |
| 1 kcal/h = 1.16 W                                 | = 0.119 kg·m/s                               |   |                                 |
| <b>Dynamic viscosity</b>                          |  |   |                                 |
| 1 Pa·s = 1 N·s/m <sup>2</sup>                     | = 10 P (poise)                               | = 0.102 kg·s/m <sup>2</sup>                       |                                 |
| 1 P = 0.1 Pa·s                                    | = 0.1 N·s/m <sup>2</sup>                     | = 1.02 × 10 <sup>-2</sup> kg·s/m <sup>2</sup>     |                                 |
| 1 kg·s/m <sup>2</sup> = 9.807 Pa·s                | = 9.807 N·s/m <sup>2</sup>                   | = 98.07 P   |                                 |

The decimal multiples and sub-multiples of a unit may be formed by prefixes or symbols, having the following meanings, placed before the name or symbol of the unit:

| Multiplying factor                            |               | Prefix | Symbol |
|---|---------------|--------|--------|
| 1 000 000 000 000 000 000 = 10 <sup>18</sup>  | quintillion   | exa    | E      |
| 1 000 000 000 000 000 = 10 <sup>15</sup>      | quadrillion   | peta   | P      |
| 1 000 000 000 000 = 10 <sup>12</sup>          | trillion      | tera   | T      |
| 1 000 000 000 = 10 <sup>9</sup>               | billion       | giga   | G      |
| 1 000 000 = 10 <sup>6</sup>                   | million       | mega   | M      |
| 1 000 = 10 <sup>3</sup>                       | thousand      | kilo   | k      |
| 100 = 10 <sup>2</sup>                         | hundred       | hecto  | h      |
| 10 = 10 <sup>1</sup>                          | ten           | deca   | da     |
| 0.1 = 10 <sup>-1</sup>                        | tenth         | deci   | d      |
| 0.01 = 10 <sup>-2</sup>                       | hundredth     | centi  | c      |
| 0.001 = 10 <sup>-3</sup>                      | thousandth    | milli  | m      |
| 0.000 001 = 10 <sup>-6</sup>                  | millionth     | micro  | μ      |
| 0.000 000 001 = 10 <sup>-9</sup>              | billionth     | nano   | n      |
| 0.000 000 000 001 = 10 <sup>-12</sup>         | trillionth    | pico   | p      |
| 0.000 000 000 000 001 = 10 <sup>-15</sup>     | quadrillionth | femto  | f      |
| 0.000 000 000 000 000 001 = 10 <sup>-18</sup> | quintillionth | atto   | a      |

**Note:** 10<sup>9</sup> = 1 billion is United Nations usage in English. By analogy, so is 10<sup>-9</sup> = 1 billionth.

1.2.2.2 [Reserved]

1.2.2.3 Whenever the mass of a package is mentioned, the gross mass is meant unless otherwise stated. The mass of containers or tanks used for the transport of goods is not included in the gross mass.

1.2.2.4 Unless expressly stated otherwise, the sign “%” represents:

- .1 in the case of mixtures of solids or of liquids, and also in the case of solutions and of solids wetted by a liquid: a percentage mass based on the total mass of the mixture, the solution or the wetted solid;
- .2 in the case of mixtures of compressed gases: when filled by pressure, the proportion of the volume indicated as a percentage of the total volume of the gaseous mixture, or, when filled by mass, the proportion of the mass indicated as a percentage of the total mass of the mixture;
- .3 in the case of mixtures of liquefied gases and gases dissolved under pressure: the proportion of the mass indicated as a percentage of the total mass of the mixture.

1.2.2.5 Pressures of all kinds relating to receptacles (such as test pressure, internal pressure, safety-valve opening pressure) are always indicated in gauge pressure (pressure in excess of atmospheric pressure); however, the vapour pressure of substances is always expressed in absolute pressure.

**1** Part 1 – General provisions, definitions and training

**1.2.2.6 Tables of equivalence**

**1.2.2.6.1 Mass conversion tables**

**1.2.2.6.1.1 Conversion factors**

| <i>Multiply</i> | <i>by</i> | <i>to obtain</i> |
|-----------------|-----------|------------------|
| Grams           | 0.03527   | Ounces           |
| Grams           | 0.002205  | Pounds           |
| Kilograms       | 35.2736   | Ounces           |
| Kilograms       | 2.2046    | Pounds           |
| Ounces          | 28.3495   | Grams            |
| Pounds          | 16        | Ounces           |
| Pounds          | 453.59    | Grams            |
| Pounds          | 0.45359   | Kilograms        |
| Hundredweight   | 112       | Pounds           |
| Hundredweight   | 50.802    | Kilograms        |

**1.2.2.6.1.2 Pounds to kilograms and vice versa**

When the central value in any row of these mass conversion tables is taken to be in pounds, its equivalent value in kilograms is shown on the left; when the central value is in kilograms, its equivalent in pounds is shown on the right.

| kg    | ← → |     | lb   | kg   | ← → |     | lb  | kg   | ← → |       | lb    |
|-------|-----|-----|------|------|-----|-----|-----|------|-----|-------|-------|
|       | lb  | kg  |      |      | lb  | kg  |     |      | lb  | kg    |       |
| 0.227 |     | 0.5 | 1.10 | 22.7 |     | 50  | 110 | 90.7 |     | 200   | 441   |
| 0.454 |     | 1   | 2.20 | 24.9 |     | 55  | 121 | 95.3 |     | 210   | 463   |
| 0.907 |     | 2   | 4.41 | 27.2 |     | 60  | 132 | 99.8 |     | 220   | 485   |
| 1.36  |     | 3   | 6.61 | 29.5 |     | 65  | 143 | 102  |     | 225   | 496   |
| 1.81  |     | 4   | 8.82 | 31.8 |     | 70  | 154 | 104  |     | 230   | 507   |
| 2.27  |     | 5   | 11.0 | 34.0 |     | 75  | 165 | 109  |     | 240   | 529   |
| 2.72  |     | 6   | 13.2 | 36.3 |     | 80  | 176 | 113  |     | 250   | 551   |
| 3.18  |     | 7   | 15.4 | 38.6 |     | 85  | 187 | 118  |     | 260   | 573   |
| 3.63  |     | 8   | 17.6 | 40.8 |     | 90  | 198 | 122  |     | 270   | 595   |
| 4.08  |     | 9   | 19.8 | 43.1 |     | 95  | 209 | 125  |     | 275   | 606   |
| 4.54  |     | 10  | 22.0 | 45.4 |     | 100 | 220 | 127  |     | 280   | 617   |
| 4.99  |     | 11  | 24.3 | 47.6 |     | 105 | 231 | 132  |     | 290   | 639   |
| 5.44  |     | 12  | 26.5 | 49.9 |     | 110 | 243 | 136  |     | 300   | 661   |
| 5.90  |     | 13  | 28.7 | 52.2 |     | 115 | 254 | 159  |     | 350   | 772   |
| 6.35  |     | 14  | 30.9 | 54.4 |     | 120 | 265 | 181  |     | 400   | 882   |
| 6.80  |     | 15  | 33.1 | 56.7 |     | 125 | 276 | 204  |     | 450   | 992   |
| 7.26  |     | 16  | 35.3 | 59.0 |     | 130 | 287 | 227  |     | 500   | 1,102 |
| 7.71  |     | 17  | 37.5 | 61.2 |     | 135 | 298 | 247  |     | 545   | 1,202 |
| 8.16  |     | 18  | 39.7 | 63.5 |     | 140 | 309 | 249  |     | 550   | 1,213 |
| 8.62  |     | 19  | 41.9 | 65.8 |     | 145 | 320 | 272  |     | 600   | 1,323 |
| 9.07  |     | 20  | 44.1 | 68.0 |     | 150 | 331 | 318  |     | 700   | 1,543 |
| 11.3  |     | 25  | 55.1 | 72.6 |     | 160 | 353 | 363  |     | 800   | 1,764 |
| 13.6  |     | 30  | 66.1 | 77.1 |     | 170 | 375 | 408  |     | 900   | 1,984 |
| 15.9  |     | 35  | 77.2 | 79.4 |     | 175 | 386 | 454  |     | 1,000 | 2,205 |
| 18.1  |     | 40  | 88.2 | 81.6 |     | 180 | 397 |      |     |       |       |
| 20.4  |     | 45  | 99.2 | 86.2 |     | 190 | 419 |      |     |       |       |

**1.2.2.6.2 Liquid measure conversion tables**

**1.2.2.6.2.1 Conversion factors**

| <i>Multiply</i> | <i>by</i> | <i>to obtain</i> |
|-----------------|-----------|------------------|
| Litres          | 0.2199    | Imperial gallons |
| Litres          | 1.759     | Imperial pints   |
| Litres          | 0.2643    | US gallons       |
| Litres          | 2.113     | US pints         |

|  |         |  |
|--|---------|--|
| Gallons                                | 8       | Pints                                  |
| Imperial gallons                       | 4.546   | Litres                                 |
| Imperial gallons }<br>Imperial pints } | 1.20095 | { US gallons<br>{ US pints             |
| Imperial pints                         | 0.568   | Litres                                 |
| US gallons                             | 3.7853  | Litres                                 |
| US gallons }<br>US pints }             | 0.83268 | { Imperial gallons<br>{ Imperial pints |
| US pints                               | 0.473   | Litres                                 |

1.2.2.6.2.2 *Imperial pints to litres and vice versa*

When the central value in any row of these liquid measure conversion tables is taken to be in pints, its equivalent value in litres is shown on the left; when the central value is in litres, its equivalent in pints is shown on the right.

| L    | ←<br>pt | →<br>L | pt    |
|------|---------|--------|-------|
| 0.28 | 0.5     |        | 0.88  |
| 0.57 | 1       |        | 1.76  |
| 0.85 | 1.5     |        | 2.64  |
| 1.14 | 2       |        | 3.52  |
| 1.42 | 2.5     |        | 4.40  |
| 1.70 | 3       |        | 5.28  |
| 1.99 | 3.5     |        | 6.16  |
| 2.27 | 4       |        | 7.04  |
| 2.56 | 4.5     |        | 7.92  |
| 2.84 | 5       |        | 8.80  |
| 3.12 | 5.5     |        | 9.68  |
| 3.41 | 6       |        | 10.56 |
| 3.69 | 6.5     |        | 11.44 |
| 3.98 | 7       |        | 12.32 |
| 4.26 | 7.5     |        | 13.20 |
| 4.55 | 8       |        | 14.08 |

**1**  
**Part 1 – General provisions, definitions and training**

**1.2.2.6.2.3 Imperial gallons to litres and vice versa**

When the central value in any row of these liquid measure conversion tables is taken to be in gallons, its equivalent value in litres is shown on the left; when the central value is in litres, its equivalent in gallons is shown on the right.

| L      | ←<br>gal | →<br>L | gal  | L        | ←<br>gal | →<br>L | gal   |
|--------|----------|--------|------|----------|----------|--------|-------|
| 2.27   | 0.5      |        | 0.11 | 159.11   | 35       |        | 7.70  |
| 4.55   | 1        |        | 0.22 | 163.65   | 36       |        | 7.92  |
| 9.09   | 2        |        | 0.44 | 168.20   | 37       |        | 8.14  |
| 13.64  | 3        |        | 0.66 | 172.75   | 38       |        | 8.36  |
| 18.18  | 4        |        | 0.88 | 177.29   | 39       |        | 8.58  |
| 22.73  | 5        |        | 1.10 | 181.84   | 40       |        | 8.80  |
| 27.28  | 6        |        | 1.32 | 186.38   | 41       |        | 9.02  |
| 31.82  | 7        |        | 1.54 | 190.93   | 42       |        | 9.24  |
| 36.37  | 8        |        | 1.76 | 195.48   | 43       |        | 9.46  |
| 40.91  | 9        |        | 1.98 | 200.02   | 44       |        | 9.68  |
| 45.46  | 10       |        | 2.20 | 204.57   | 45       |        | 9.90  |
| 50.01  | 11       |        | 2.42 | 209.11   | 46       |        | 10.12 |
| 54.55  | 12       |        | 2.64 | 213.66   | 47       |        | 10.34 |
| 59.10  | 13       |        | 2.86 | 218.21   | 48       |        | 10.56 |
| 63.64  | 14       |        | 3.08 | 222.75   | 49       |        | 10.78 |
| 68.19  | 15       |        | 3.30 | 227.30   | 50       |        | 11.00 |
| 72.74  | 16       |        | 3.52 | 250.03   | 55       |        | 12.09 |
| 77.28  | 17       |        | 3.74 | 272.76   | 60       |        | 13.20 |
| 81.83  | 18       |        | 3.96 | 295.49   | 65       |        | 14.29 |
| 86.37  | 19       |        | 4.18 | 318.22   | 70       |        | 15.40 |
| 90.92  | 20       |        | 4.40 | 340.95   | 75       |        | 16.49 |
| 95.47  | 21       |        | 4.62 | 363.68   | 80       |        | 17.60 |
| 100.01 | 22       |        | 4.84 | 386.41   | 85       |        | 18.69 |
| 104.56 | 23       |        | 5.06 | 409.14   | 90       |        | 19.80 |
| 109.10 | 24       |        | 5.28 | 431.87   | 95       |        | 20.89 |
| 113.65 | 25       |        | 5.50 | 454.60   | 100      |        | 22.00 |
| 118.19 | 26       |        | 5.72 | 613.71   | 135      |        | 29.69 |
| 122.74 | 27       |        | 5.94 | 681.90   | 150      |        | 32.98 |
| 127.29 | 28       |        | 6.16 | 909.20   | 200      |        | 43.99 |
| 131.83 | 29       |        | 6.38 | 1,022.85 | 225      |        | 49.48 |
| 136.38 | 30       |        | 6.60 | 1,136.50 | 250      |        | 54.97 |
| 140.92 | 31       |        | 6.82 | 1,363.80 | 300      |        | 65.99 |
| 145.47 | 32       |        | 7.04 | 1,591.10 | 350      |        | 76.96 |
| 150.02 | 33       |        | 7.26 | 1,818.40 | 400      |        | 87.99 |
| 154.56 | 34       |        | 7.48 | 2,045.70 | 450      |        | 98.95 |

1.2.2.6.3 *Temperature conversion tables*

*Degrees Fahrenheit to degrees Celsius and vice versa*

When the central value in any row of these temperature conversion tables is taken to be in °F, its equivalent value in °C is shown on the left; when the central value is in °C, its equivalent in °F is shown on the right.

General formula:  $^{\circ}\text{F} = (^{\circ}\text{C} \times \frac{9}{5}) + 32$ ;  $^{\circ}\text{C} = (^{\circ}\text{F} - 32) \times \frac{5}{9}$

| °C    | ← °F | → °C  | °F | °C    | ← °F | → °C | °F | °C   | ← °F | → °C  | °F |
|-------|------|-------|----|-------|------|------|----|------|------|-------|----|
| -73.3 | -100 | -148  |    | -21.1 | -6   | 21.2 |    | 1.1  | 34   | 93.2  |    |
| -67.8 | -90  | -130  |    | -20.6 | -5   | 23.0 |    | 1.7  | 35   | 95    |    |
| -62.2 | -80  | -112  |    | -20.0 | -4   | 24.8 |    | 2.2  | 36   | 96.8  |    |
| -56.7 | -70  | -94   |    | -19.4 | -3   | 26.6 |    | 2.8  | 37   | 98.6  |    |
| -51.1 | -60  | -76   |    | -18.9 | -2   | 28.4 |    | 3.3  | 38   | 100.4 |    |
|       |      |       |    |       |      |      |    |      |      |       |    |
| -45.6 | -50  | -58   |    | -18.3 | -1   | 30.2 |    | 3.9  | 39   | 102.2 |    |
| -40   | -40  | -40   |    | -17.8 | 0    | 32.0 |    | 4.4  | 40   | 104   |    |
| -39.4 | -39  | -38.2 |    | -17.2 | 1    | 33.8 |    | 5    | 41   | 105.8 |    |
| -38.9 | -38  | -36.4 |    | -16.7 | 2    | 35.6 |    | 5.6  | 42   | 107.6 |    |
| -38.3 | -37  | -34.6 |    | -16.1 | 3    | 37.4 |    | 6.1  | 43   | 109.4 |    |
|       |      |       |    |       |      |      |    |      |      |       |    |
| -37.8 | -36  | -32.8 |    | -15.6 | 4    | 39.2 |    | 6.7  | 44   | 111.2 |    |
| -37.2 | -35  | -31   |    | -15.0 | 5    | 41.0 |    | 7.2  | 45   | 113   |    |
| -36.7 | -34  | -29.2 |    | -14.4 | 6    | 42.8 |    | 7.8  | 46   | 114.8 |    |
| -36.1 | -33  | -27.4 |    | -13.9 | 7    | 44.6 |    | 8.3  | 47   | 116.6 |    |
| -35.6 | -32  | -25.6 |    | -13.3 | 8    | 46.4 |    | 8.9  | 48   | 118.4 |    |
|       |      |       |    |       |      |      |    |      |      |       |    |
| -35   | -31  | -23.8 |    | -12.8 | 9    | 48.2 |    | 9.4  | 49   | 120.2 |    |
| -34.4 | -30  | -22   |    | -12.2 | 10   | 50.0 |    | 10.0 | 50   | 122.0 |    |
| -33.9 | -29  | -20.2 |    | -11.7 | 11   | 51.8 |    | 10.6 | 51   | 123.8 |    |
| -33.3 | -28  | -18.4 |    | -11.1 | 12   | 53.6 |    | 11.1 | 52   | 125.6 |    |
| -32.8 | -27  | -16.6 |    | -10.6 | 13   | 55.4 |    | 11.7 | 53   | 127.4 |    |
|       |      |       |    |       |      |      |    |      |      |       |    |
| -32.2 | -26  | -14.8 |    | -10.0 | 14   | 57.2 |    | 12.2 | 54   | 129.2 |    |
| -31.7 | -25  | -13   |    | -9.4  | 15   | 59.0 |    | 12.8 | 55   | 131.0 |    |
| -31.1 | -24  | -11.2 |    | -8.9  | 16   | 60.8 |    | 13.3 | 56   | 132.8 |    |
| -30.6 | -23  | -9.4  |    | -8.3  | 17   | 62.6 |    | 13.9 | 57   | 134.6 |    |
| -30   | -22  | -7.6  |    | -7.8  | 18   | 64.4 |    | 14.4 | 58   | 136.4 |    |
|       |      |       |    |       |      |      |    |      |      |       |    |
| -29.4 | -21  | -5.8  |    | -7.2  | 19   | 66.2 |    | 15.0 | 59   | 138.2 |    |
| -28.9 | -20  | -4    |    | -6.7  | 20   | 68   |    | 15.6 | 60   | 140.0 |    |
| -28.3 | -19  | -2.2  |    | -6.1  | 21   | 69.8 |    | 16.1 | 61   | 141.8 |    |
| -27.8 | -18  | -0.4  |    | -5.6  | 22   | 71.6 |    | 16.7 | 62   | 143.6 |    |
| -27.2 | -17  | 1.4   |    | -5    | 23   | 73.4 |    | 17.2 | 63   | 145.4 |    |
|       |      |       |    |       |      |      |    |      |      |       |    |
| -26.7 | -16  | 3.2   |    | -4.4  | 24   | 75.2 |    | 17.8 | 64   | 147.2 |    |
| -26.1 | -15  | 5     |    | -3.9  | 25   | 77   |    | 18.3 | 65   | 149.0 |    |
| -25.6 | -14  | 6.8   |    | -3.3  | 26   | 78.8 |    | 18.9 | 66   | 150.8 |    |
| -25.0 | -13  | 8.6   |    | -2.8  | 27   | 80.6 |    | 19.4 | 67   | 152.6 |    |
| -24.4 | -12  | 10.4  |    | -2.2  | 28   | 82.4 |    | 20.0 | 68   | 154.4 |    |
|       |      |       |    |       |      |      |    |      |      |       |    |
| -23.9 | -11  | 12.2  |    | -1.7  | 29   | 84.2 |    | 20.6 | 69   | 156.2 |    |
| -23.3 | -10  | 14.0  |    | -1.1  | 30   | 86   |    | 21.1 | 70   | 158.0 |    |
| -22.8 | -9   | 15.8  |    | -0.6  | 31   | 87.8 |    | 21.7 | 71   | 159.8 |    |
| -22.2 | -8   | 17.6  |    | 0     | 32   | 89.6 |    | 22.2 | 72   | 161.6 |    |
| -21.7 | -7   | 19.4  |    | 0.6   | 33   | 91.4 |    | 22.8 | 73   | 163.4 |    |

1  
Part 1 – General provisions, definitions and training

| °C   | ←<br>°F | →<br>°C | °F    | °C   | ←<br>°F | →<br>°C | °F    | °C    | ←<br>°F | →<br>°C | °F    |
|------|---------|---------|-------|------|---------|---------|-------|-------|---------|---------|-------|
| 23.3 | 74      |         | 165.2 | 37.8 | 100     |         | 212   | 52.2  | 126     |         | 258.8 |
| 23.9 | 75      |         | 167.0 | 38.3 | 101     |         | 213.8 | 52.8  | 127     |         | 260.6 |
| 24.4 | 76      |         | 168.8 | 38.9 | 102     |         | 215.6 | 53.3  | 128     |         | 262.4 |
| 25.0 | 77      |         | 170.6 | 39.4 | 103     |         | 217.4 | 53.9  | 129     |         | 264.2 |
| 25.6 | 78      |         | 172.4 | 40   | 104     |         | 219.2 | 54.4  | 130     |         | 266.0 |
|      |         |         |       |      |         |         |       |       |         |         |       |
| 26.1 | 79      |         | 174.2 | 40.6 | 105     |         | 221   | 55.0  | 131     |         | 267.8 |
| 26.7 | 80      |         | 176.0 | 41.1 | 106     |         | 222.8 | 55.6  | 132     |         | 269.6 |
| 27.2 | 81      |         | 177.8 | 41.7 | 107     |         | 224.6 | 56.1  | 133     |         | 271.4 |
| 27.8 | 82      |         | 179.6 | 42.2 | 108     |         | 226.4 | 56.7  | 134     |         | 273.2 |
| 28.3 | 83      |         | 181.4 | 42.8 | 109     |         | 228.2 | 57.2  | 135     |         | 275.0 |
|      |         |         |       |      |         |         |       |       |         |         |       |
| 28.9 | 84      |         | 183.2 | 43.3 | 110     |         | 230   | 57.8  | 136     |         | 276.8 |
| 29.4 | 85      |         | 185   | 43.9 | 111     |         | 231.8 | 58.3  | 137     |         | 278.6 |
| 30   | 86      |         | 186.8 | 44.4 | 112     |         | 233.6 | 58.9  | 138     |         | 280.4 |
| 30.6 | 87      |         | 188.6 | 45   | 113     |         | 235.4 | 59.4  | 139     |         | 282.2 |
| 31.1 | 88      |         | 190.4 | 45.6 | 114     |         | 237.2 | 60.0  | 140     |         | 284.0 |
|      |         |         |       |      |         |         |       |       |         |         |       |
| 31.7 | 89      |         | 192.2 | 46.1 | 115     |         | 239.0 | 65.6  | 150     |         | 302.0 |
| 32.2 | 90      |         | 194   | 46.7 | 116     |         | 240.8 | 71.1  | 160     |         | 320.0 |
| 32.8 | 91      |         | 195.8 | 47.2 | 117     |         | 242.6 | 76.7  | 170     |         | 338.0 |
| 33.3 | 92      |         | 197.6 | 47.8 | 118     |         | 244.4 | 82.2  | 180     |         | 356.0 |
| 33.9 | 93      |         | 199.4 | 48.3 | 119     |         | 246.2 | 87.8  | 190     |         | 374.0 |
|      |         |         |       |      |         |         |       |       |         |         |       |
| 34.4 | 94      |         | 201.2 | 48.9 | 120     |         | 248.0 | 93.3  | 200     |         | 392.0 |
| 35   | 95      |         | 203   | 49.4 | 121     |         | 249.8 | 98.9  | 210     |         | 410.0 |
| 35.6 | 96      |         | 204.8 | 50.0 | 122     |         | 251.6 | 104.4 | 220     |         | 428.0 |
| 36.1 | 97      |         | 206.6 | 50.6 | 123     |         | 253.4 | 110.0 | 230     |         | 446.0 |
| 36.7 | 98      |         | 208.4 | 51.1 | 124     |         | 255.2 | 115.6 | 240     |         | 464.0 |
| 37.2 | 99      |         | 210.2 | 51.7 | 125     |         | 257.0 | 121.1 | 250     |         | 482.0 |

### 1.2.3 List of abbreviations

|                |  |
|----------------|--|
| ASTM           | American Society for Testing and Materials (ASTM International, 100 Barr Harbor Drive, P.O. Box C700, West Conshohocken, PA, 19428-2959, United States of America) |
| CGA            | Compressed Gas Association (CGA, 14501 George Carter Way, Suite 103, Chantilly, VA 20151, United States of America)  |
| CCC            | IMO Sub-Committee on Carriage of Cargoes and Containers  |
| CSC            | <i>International Convention for Safe Containers, 1972</i> (CSC Convention), as amended   |
| ECOSOC         | Economic and Social Council (UN)   |
| EmS            | The EmS Guide: Revised Emergency Response Procedures for Ships Carrying Dangerous Goods  |
| EN (standard)  | European standard published by the European Committee for Standardization (CEN) (CEN, 36 rue de Stassart, B-1050 Brussels, Belgium)                                |
| FAO            | Food and Agriculture Organization (FAO, Viale delle Terme di Caracalla, 00100 Rome, Italy)   |
| HNS Convention | <i>International Convention on Liability and Compensation for Damage in Connection with the Carriage of Hazardous and Noxious Substances by Sea</i> (IMO)          |
| IAEA           | International Atomic Energy Agency (IAEA, P.O. Box 100, A – 1400 Vienna, Austria)  |
| ICAO           | International Civil Aviation Organization (ICAO, 999 University Street, Montreal, Quebec H3C 5H7, Canada)  |
| IEC            | International Electrotechnical Commission (IEC, 3 rue de Varembe, P.O. Box 131, CH-1211 Geneva 20, Switzerland)  |
| ILO            | International Labour Organization/Office (ILO, 4 route des Morillons, CH-1211 Geneva 22, Switzerland)  |

## Chapter 1.2 – Definitions, units of measurement and abbreviations

1

|                |   |
|----------------|---|
| IMGS           | <i>International Medical Guide for Ships</i>  |
| IMO            | International Maritime Organization (IMO, 4 Albert Embankment, London SE1 7SR, United Kingdom)  |
| IMDG Code      | <i>International Maritime Dangerous Goods Code</i>  |
| IMSBC Code     | <i>International Maritime Solid Bulk Cargoes Code</i>   |
| INF Code       | <i>International Code for the Safe Carriage of Packaged Irradiated Nuclear Fuel, Plutonium and High-Level Radioactive Wastes on board Ships</i>           |
| ISO (standard) | An international standard published by the International Organization for Standardization (ISO, 1, ch. de la Voie-Creuse, CH-1211 Geneva 20, Switzerland) |
| MARPOL         | <i>International Convention for the Prevention of Pollution from Ships, 1973</i> , as amended by the 1978 and 1997 Protocols relating thereto             |
| MAWP           | Maximum allowable working pressure  |
| MEPC           | Marine Environment Protection Committee (IMO)   |
| MFAG           | Medical First Aid Guide for use in Accidents Involving Dangerous Goods  |
| MSC            | Maritime Safety Committee (IMO)   |
| N.O.S.         | not otherwise specified   |
| SADT           | self-accelerating decomposition temperature   |
| SAPT           | self-accelerating polymerization temperature  |
| SOLAS          | <i>International Convention for the Safety of Life at Sea, 1974</i> , as amended  |
| UNECE          | United Nations Economic Commission for Europe (UNECE, Palais des Nations, 8–14 avenue de la Paix, CH-1211 Geneva 10, Switzerland)                         |
| UN number      | four-digit United Nations number is assigned to dangerous, hazardous and harmful substances, materials and articles most commonly transported             |
| UNEP           | United Nations Environment Programme (United Nations Avenue, Gigiri, PO Box 30552, 00100, Nairobi, Kenya)   |
| UNESCO/IOC     | UN Educational, Scientific and Cultural Organization/Intergovernmental Oceanographic Commission (UNESCO/IOC, 1 rue Miollis, 75732 Paris Cedex 15, France) |
| WHO            | World Health Organization (Avenue Appia 20, CH-1211 Geneva 27, Switzerland)   |
| WMO            | World Meteorological Organization (WMO, 7bis, avenue de la Paix, Case postale No. 2300, CH-1211 Geneva 2, Switzerland)                                    |



## Chapter 1.3

---

### Training

#### 1.3.0 Introductory note

The successful application of regulations concerning the transport of dangerous goods and the achievement of their objectives are greatly dependent on the appreciation by all persons concerned of the risks involved and on a detailed understanding of the regulations. This can only be achieved by properly planned and maintained initial and retraining programmes for all persons concerned with the transport of dangerous goods. The provisions of paragraphs 1.3.1.4 to 1.3.1.7 remain recommendatory (see 1.1.1.5).

#### 1.3.1 Training of shore-side personnel

**1.3.1.1** Shore-based personnel\* engaged in the transport of dangerous goods intended to be transported by sea shall be trained in the contents of dangerous goods provisions commensurate with their responsibilities. Employees shall be trained in accordance with the provisions of 1.3.1 before assuming responsibilities and shall only perform functions, for which required training has not yet been provided, under the direct supervision of a trained person. Training requirements specific to security of dangerous goods in chapter 1.4 shall also be addressed.

Entities engaging shore-based personnel in such activities shall determine which staff will be trained, what levels of training they require and the training methods used to enable them to comply with the provisions of the IMDG Code. This training shall be provided or verified upon employment in a position involving dangerous goods transport. For personnel who have not yet received the required training, the entities shall ensure that those personnel may only perform functions under the direct supervision of a trained person. The training shall be periodically supplemented with refresher training to take account of changes in regulations and practice. The competent authority, or its authorized body, may audit the entity to verify the effectiveness of the system in place, in providing training of staff commensurate with their role and responsibilities in the transport chain.

**1.3.1.2** Shore-based personnel such as those who:

- classify dangerous goods and identify proper shipping names of dangerous goods;
  - pack dangerous goods;
  - mark, label or placard dangerous goods;
  - load/unload cargo transport units;
  - prepare transport documents for dangerous goods;
  - offer dangerous goods for transport;
  - accept dangerous goods for transport;
  - handle dangerous goods in transport;
  - prepare dangerous goods loading/stowage plans;
  - load/unload dangerous goods into/from ships;
  - carry dangerous goods in transport;
  - enforce or survey or inspect for compliance with applicable rules and regulations; or
  - are otherwise involved in the transport of dangerous goods as determined by the competent authority
- shall be trained in the following:

**1.3.1.2.1** *General awareness/familiarization training:*

- .1 each person shall be trained in order to be familiar with the general provisions of dangerous goods transport provisions;

---

\* For the training of officers and ratings responsible for cargo handling on ships carrying dangerous and hazardous substances in solid form in bulk, or in packaged form, see the STCW Code, as amended.

- .2 such training shall include a description of the classes of dangerous goods; labelling, marking, placarding, packing, stowage, segregation and compatibility provisions; a description of the purpose and content of the dangerous goods transport documents (such as the Multimodal Dangerous Goods Form and the Container/Vehicle Packing Certificate); and a description of available emergency response documents.

**1.3.1.2.2** *Function-specific training:* Each person shall be trained in specific dangerous goods transport provisions which are applicable to the function that person performs. An indicative list, for guidance purposes only, of some of the functions typically found in dangerous goods transport operations by sea and training requirements is given in paragraph 1.3.1.6.

**1.3.1.3** Records of training received according to this chapter shall be kept by the employer and made available to the employee or competent authority, upon request. Records shall be kept by the employer for a period of time established by the competent authority.

**1.3.1.4** *Safety training:* Commensurate with the risk of exposure in the event of a release and the functions performed, each person should be trained in:

- .1 methods and procedures for accident avoidance, such as proper use of package-handling equipment and appropriate methods of stowage of dangerous goods;
- .2 available emergency response information and how to use it;
- .3 general dangers presented by the various classes of dangerous goods and how to prevent exposure to those hazards, including, if appropriate, the use of personal protective clothing and equipment; and
- .4 immediate procedures to be followed in the event of an unintentional release of dangerous goods, including any emergency response procedures for which the person is responsible and personal protection procedures to be followed.

**1.3.1.5 Recommended training needs for shore-side personnel involved in the transport of dangerous goods under the IMDG Code**

The following indicative table is for information purposes only as every entity is arranged differently and may have varied roles and responsibilities within that entity.

| Function   | Specific training requirements   | Numbers in this column refer to the list of related codes and publications in 1.3.1.7 |
|--|--|---|
| 1 Classify dangerous goods and identify proper shipping name | Classification requirements, in particular <ul style="list-style-type: none"> <li>– the structure of the description of substances</li> <li>– the classes of dangerous goods and the principles of their classification</li> <li>– the nature of the dangerous substances and articles transported (their physical, chemical and toxicological properties)</li> <li>– the procedure for classifying solutions and mixtures</li> <li>– identification by proper shipping name</li> <li>– use of Dangerous Goods List</li> </ul> | .1, .4, .5 and .12  |
| 2 Pack dangerous goods                                       | Classes<br>Packaging requirements <ul style="list-style-type: none"> <li>– type of packages (IBC, large packaging, tank container and bulk container)</li> <li>– UN marking for approved packagings</li> <li>– segregation requirements</li> <li>– limited quantities and excepted quantities</li> </ul> Marking and labelling<br>First aid measures<br>Emergency response procedures<br>Safe handling procedures  | .1 and .4   |
| 3 Mark, label or placard dangerous goods                     | Classes<br>Marking, labelling and placarding requirements <ul style="list-style-type: none"> <li>– primary and subsidiary hazard labels</li> <li>– marine pollutants</li> <li>– limited quantities and excepted quantities</li> </ul>  | .1  |

1  
Part 1 – General provisions, definitions and training

| Function  | Specific training requirements  | Numbers in this column refer to the list of related codes and publications in 1.3.1.7 |
|---|---|---|
| 4 Load/unload cargo transport units               | Documentation<br>Classes<br>Marking, labelling and placarding<br>Stowage requirements, where applicable<br>Segregation requirements<br>Cargo securing requirements (as contained in the CTU Code)<br>Emergency response procedures<br>First aid measures<br>CSC requirements<br>Safe handling procedures  | .1, .6, .7 and .8   |
| 5 Prepare transport documents for dangerous goods | Documentation requirements <ul style="list-style-type: none"> <li>– transport document</li> <li>– container/vehicle packing certificate</li> <li>– competent authorities' approval</li> <li>– waste transport documentation</li> <li>– special documentation, where appropriate</li> </ul>  | .1  |
| 6 Offer dangerous goods for transport             | Thorough knowledge of the IMDG Code<br>Local requirements at loading and discharge ports <ul style="list-style-type: none"> <li>– port byelaws</li> <li>– national transport regulations</li> </ul>   | .1 to .10 and .12   |
| 7 Accept dangerous goods for transport            | Thorough knowledge of the IMDG Code<br>Local requirements at loading, transiting and discharge ports <ul style="list-style-type: none"> <li>– port byelaws, in particular quantity limitations</li> <li>– national transport regulations</li> </ul>   | .1 to .12   |
| 8 Handle dangerous goods in transport             | Classes and their hazards<br>Marking, labelling and placarding<br>Emergency response procedures<br>First aid measures<br>Safe handling procedures such as <ul style="list-style-type: none"> <li>– use of equipment</li> <li>– appropriate tools</li> <li>– safe working loads</li> </ul> CSC requirements, local requirements at loading, transit and discharge ports<br>Port byelaws, in particular, quantity limitation<br>National transport regulations                                | .1, .2, .3, .6, .7, .8 and .10  |
| 9 Prepare dangerous goods loading/stowage plans   | Documentation<br>Classes<br>Stowage requirements<br>Segregation requirements<br>Document of compliance<br>Relevant IMDG Code parts, local requirements at loading, transit and discharge ports<br>Port byelaws, in particular, quantity limitations   | .1, .10, .11 and .12  |
| 10 Load/unload dangerous goods into/from ships    | Classes and their hazards<br>Marking, labelling and placarding<br>Emergency response procedures<br>First aid measures<br>Safe handling procedures such as <ul style="list-style-type: none"> <li>– use of equipment</li> <li>– appropriate tools</li> <li>– safe working loads</li> </ul> Cargo securing requirements<br>CSC requirements, local requirements at loading, transit and discharge ports<br>Port byelaws, in particular, quantity limitation<br>National transport regulations | .1, .2, .3, .7, .9, .10 and .12   |



## 1

### Part 1 – General provisions, definitions and training

---

#### 1.3.1.7 Related Codes and publications which may be appropriate for function-specific training

- .1 *International Maritime Dangerous Goods Code (IMDG Code)*, as amended
- .2 *The EmS Guide: Revised Emergency Response Procedures for Ships Carrying Dangerous Goods (EmS)*
- .3 *Medical First Aid Guide for Use in Accidents Involving Dangerous Goods (MFAG)*, as amended
- .4 *United Nations Recommendations on the Transport of Dangerous Goods – Model Regulations*, as amended
- .5 *United Nations Recommendations on the Transport of Dangerous Goods – Manual of Tests and Criteria*, as amended
- .6 *IMO/ILO/UNECE Code of Practice for Packing of Cargo Transport Units (CTU Code)*
- .7 *Recommendations on the Safe Transport of Dangerous Cargoes and Related Activities in Port Areas*
- .8 *International Convention for Safe Containers, 1972 (CSC Convention)*, as amended
- .9 *Code of Safe Practice for Cargo Stowage and Securing (CSS Code)*, as amended
- .10 *Revised Recommendations on the safe use of pesticides in ships applicable to the fumigation of cargo transport units (MSC.1/Circ.1361/Rev.1)*
- .11 *International Convention for the Safety of Life at Sea, 1974 (SOLAS)*, as amended
- .12 *International Convention for the Prevention of Pollution from Ships, 1973 as modified by the Protocol of 1978 (MARPOL)*, as amended.
- .13 *Inspection programmes for cargo transport units carrying dangerous goods (MSC.1/Circ.1442, as amended by MSC.1/Circ.1521)*.

## Chapter 1.4

### Security provisions

---

#### 1.4.0 Scope

1.4.0.1 The provisions of this chapter address the security of dangerous goods in transport by sea. National competent authorities may apply additional security provisions, which should be considered when offering or transporting dangerous goods. The provisions of this chapter remain recommendatory except 1.4.1.1 (see 1.1.1.5).

1.4.0.2 The provisions of 1.4.2 and 1.4.3 do not apply to:

- .1 UN 2908 and UN 2909 excepted packages;
- .2 UN 2910 and UN 2911 excepted packages with an activity level not exceeding the  $A_2$  value; and
- .3 UN 2912 LSA-I and UN 2913 SCO-I.

#### 1.4.1 General provisions for companies, ships and port facilities\*

1.4.1.1 The relevant provisions of chapter XI-2 of SOLAS, as amended, and of part A of the *International Ship and Port Facility Security Code* (ISPS Code) apply to companies, ships and port facilities engaged in the transport of dangerous goods and to which regulation XI-2 of SOLAS, as amended, apply taking into account the guidance given in part B of the ISPS Code.

1.4.1.2 For cargo ships of less than 500 gross tons engaged in the transport of dangerous goods, it is recommended that Contracting Governments to SOLAS, as amended, consider security provisions for these cargo ships.

1.4.1.3 Any shore-based company personnel, ship-based personnel and port facility personnel engaged in the transport of dangerous goods should be aware of the security requirements for such goods, in addition to those specified in the ISPS Code, and commensurate with their responsibilities.

1.4.1.4 The training of the company security officer, shore-based company personnel having specific security duties, port facility security officer and port facility personnel having specific duties, engaged in the transport of dangerous goods, should also include elements of security awareness related to those goods.

1.4.1.5 All shipboard personnel and port facility personnel who are not mentioned in 1.4.1.4 and are engaged in the transport of dangerous goods should be familiar with the provisions of the relevant security plans related to those goods, commensurate with their responsibilities.

#### 1.4.2 General provisions for shore-side personnel

1.4.2.1 For the purpose of this subsection, shore-side personnel covers individuals mentioned in 1.3.1.2. However, the provisions of 1.4.2 do not apply to:

- the company security officer and appropriate shore-based company personnel mentioned in 13.1 of part A of the ISPS Code,
- the ship security officer and the shipboard personnel mentioned in 13.2 and 13.3 of part A of the ISPS Code,
- the port facility security officer, the appropriate port facility security personnel and the port facility personnel having specific security duties mentioned in 18.1 and 18.2 of part A of the ISPS Code.

For the training of those officers and personnel, refer to the *International Ship and Port Facility Security Code* (ISPS Code).

\* Refer to *Guidelines on security-related training and familiarization for port facility personnel* (MSC.1/Circ.1341) and to *Guidelines on training and certification for port facility security officers* (MSC.1/Circ.1188).

**1**  
**Part 1 – General provisions, definitions and training**

1.4.2.2 Shore-side personnel engaged in transport by sea of dangerous goods should consider security provisions for the transport of dangerous goods commensurate with their responsibilities.

**1.4.2.3 Security training**

1.4.2.3.1 The training of shore-side personnel, as specified in chapter 1.3, shall also include elements of security awareness.

1.4.2.3.2 Security awareness training should address the nature of security risks, recognizing security risks, methods to address and reduce risks and actions to be taken in the event of a security breach. It should include awareness of security plans (if appropriate, refer to 1.4.3) commensurate with the responsibilities of individuals and their part in implementing security plans.

1.4.2.3.3 Such training should be provided or verified upon employment in a position involving dangerous goods transport and should be periodically supplemented with retraining.

1.4.2.3.4 Records of all security training received should be kept by the employer and made available to the employee or competent authority, upon request. Records should be kept by the employer for a period of time established by the competent authority.

**1.4.3 Provisions for high consequence dangerous goods**

**1.4.3.1 Definition of high consequence dangerous goods**

1.4.3.1.1 High consequence dangerous goods are those which have the potential for misuse in a terrorist event and which may, as a result, produce serious consequences such as mass casualties, mass destruction or, particularly for class 7, mass socio-economic disruption.

1.4.3.1.2 An indicative list of high consequence dangerous goods in classes and divisions other than class 7 is given in table 1.4.1 below.

**Table 1.4.1 – Indicative list of high consequence dangerous goods**

|                       |   |
|-----------------------|---|
| Class 1, Division 1.1 | explosives  |
| Class 1, Division 1.2 | explosives  |
| Class 1, Division 1.3 | compatibility group C explosives  |
| Class 1, Division 1.4 | UN Nos. 0104, 0237, 0255, 0267, 0289, 0361, 0365, 0366, 0440, 0441, 0455, 0456, 0500, 0512 and 0513   |
| Class 1, Division 1.5 | explosives  |
| Class 1, Division 1.6 | explosives  |
| Class 2.1             | flammable gases in quantities greater than 3,000 L in a road tank vehicle, a railway tank wagon or a portable tank  |
| Class 2.3             | toxic gases   |
| Class 3               | flammable liquids of packing groups I and II in quantities greater than 3,000 L in a road tank vehicle, a railway tank wagon or a portable tank   |
| Class 3               | liquid desensitized explosives  |
| Class 4.1             | solid desensitized explosives   |
| Class 4.2             | goods of packing group I in quantities greater than 3,000 kg or 3,000 L in a road tank vehicle, a railway tank wagon, a portable tank or a bulk container   |
| Class 4.3             | goods of packing group I in quantities greater than 3,000 kg or 3,000 L in a road tank vehicle, a railway tank wagon, a portable tank or a bulk container   |
| Class 5.1             | oxidizing liquids of packing group I in quantities greater than 3,000 L in a road tank vehicle, a railway tank wagon or a portable tank   |
| Class 5.1             | perchlorates, ammonium nitrate, ammonium nitrate fertilizers and ammonium nitrate emulsions or suspensions or gels in quantities greater than 3,000 kg or 3,000 L in a road tank vehicle, a railway tank wagon, a portable tank or a bulk container |

- Class 6.1 toxic substances of packing group I
- Class 6.2 infectious substances of Category A (UN 2814 and UN 2900) and medical waste of Category A (UN 3549)
- Class 8 corrosive substances of packing group I in quantities greater than 3,000 kg or 3,000 L in a road tank vehicle, a railway tank wagon, a portable tank or a bulk container

1.4.3.1.3 For dangerous goods of class 7, high consequence radioactive material is that with an activity equal to or greater than a transport security threshold of 3,000 A<sub>2</sub> per single package (see also 2.7.2.2.1) except for the following radionuclides where the transport security threshold is given in table 1.4.2 below.

Table 1.4.2 – Transport security thresholds for specific radionuclides

| Element     | Radionuclide | Transport security threshold (TBq) |
|-------------|--------------|------------------------------------|
| Americium   | Am-241       | 0.6                                |
| Gold        | Au-198       | 2                                  |
| Cadmium     | Cd-109       | 200                                |
| Californium | Cf-252       | 0.2                                |
| Curium      | Cm-244       | 0.5                                |
| Cobalt      | Co-57        | 7                                  |
| Cobalt      | Co-60        | 0.3                                |
| Caesium     | Cs-137       | 1                                  |
| Iron        | Fe-55        | 8,000                              |
| Germanium   | Ge-68        | 7                                  |
| Gadolinium  | Gd-153       | 10                                 |
| Iridium     | Ir-192       | 0.8                                |
| Nickel      | Ni-63        | 600                                |
| Palladium   | Pd-103       | 900                                |
| Promethium  | Pm-147       | 400                                |
| Polonium    | Po-210       | 0.6                                |
| Plutonium   | Pu-238       | 0.6                                |
| Plutonium   | Pu-239       | 0.6                                |
| Radium      | Ra-226       | 0.4                                |
| Ruthenium   | Ru-106       | 3                                  |
| Selenium    | Se-75        | 2                                  |
| Strontium   | Sr-90        | 10                                 |
| Thallium    | Tl-204       | 200                                |
| Thulium     | Tm-170       | 200                                |
| Ytterbium   | Yb-169       | 3                                  |

1.4.3.1.4 For mixtures of radionuclides, determination of whether or not the transport security threshold has been met or exceeded can be calculated by summing the ratios of activity present for each radionuclide divided by the transport security threshold for that radionuclide. If the sum of the fractions is less than 1, then the radioactivity threshold for the mixture has not been met nor exceeded.

This calculation can be made with the formula:

$$\sum_i \frac{A_i}{T_i} < 1$$

where:

A<sub>i</sub> = activity of radionuclide *i* that is present in a package (TBq)

T<sub>i</sub> = transport security threshold for radionuclide *i* (TBq).



## 1 Part 1 – General provisions, definitions and training

---

1.4.3.1.5 When radioactive materials possess subsidiary hazards of other classes or divisions, the criteria of table 1.4.1 should also be taken into account (see also 1.5.5.1).

### 1.4.3.2 Specific security provisions for high consequence dangerous goods

1.4.3.2.1 The provisions of this section do not apply to ships and to port facilities (see the ISPS Code for ship security plan and for port facility security plan).

**Note:** In addition to the security provisions of this Code, competent authorities may implement further security provisions for reasons other than safety of dangerous goods during transport. In order to not impede international and multimodal transport by different explosives security marks, it is recommended that such marks be formatted consistent with an internationally harmonized standard (e.g. European Union Commission Directive 2008/43/EC).

#### 1.4.3.2.2 Security plans

1.4.3.2.2.1 Consignors and others engaged in the transport of high consequence dangerous goods (see 1.4.3.1) should adopt, implement and comply with a security plan that addresses at least the elements specified in 1.4.3.2.2.2.

1.4.3.2.2.2 The security plan should comprise at least the following elements:

- .1 specific allocation of responsibilities for security to competent and qualified persons with appropriate authority to carry out their responsibilities;
- .2 records of dangerous goods or types of dangerous goods transported;
- .3 review of current operations and assessment of vulnerabilities, including intermodal transfer, temporary transit storage, handling and distribution, as appropriate;
- .4 clear statements of measures, including training, policies (including response to higher threat conditions, new employee/employment verification, etc.), operating practices (e.g. choice/use of routes where known, access to dangerous goods in temporary storage, proximity to vulnerable infrastructure, etc.), equipment and resources that are to be used to reduce security risks;
- .5 effective and up-to-date procedures for reporting and dealing with security threats, breaches of security or security-related incidents;
- .6 procedures for the evaluation and testing of security plans and procedures for periodic review and update of the plans;
- .7 measures to ensure the security of transport information contained in the plan; and
- .8 measures to ensure that the distribution of transport information is limited as far as possible. (Such measures shall not preclude provision of transport documentation required by chapter 5.4 of this Code.)

1.4.3.2.3 For radioactive material, the provisions of this chapter are deemed to be complied with when the provisions of the Convention on Physical Protection of Nuclear Material (INFCIRC/274/Rev.1, IAEA, Vienna (1980)) and the IAEA circular on *Nuclear Security Recommendations on Physical Protection of Nuclear Material and Nuclear Facilities* (INFCIRC/225/Rev.5, IAEA, Vienna (2011)) are applied.

## Chapter 1.5

### *General provisions concerning radioactive material*

#### 1.5.1 Scope and application

1.5.1.1 The provisions of this Code establish standards of safety which provide an acceptable level of control of the radiation, criticality and thermal hazards to people, property and the environment that are associated with the transport of radioactive material. These provisions are based on the 2018 edition of the *IAEA Regulations for the Safe Transport of Radioactive Material*. Explanatory material can be found in *Advisory Material for the IAEA Regulations for the Safe Transport of Radioactive Material* (2018 Edition), *Safety Standard Series No. SSG-26 (Rev.1)*, IAEA, Vienna (2019).

1.5.1.2 The objective of this Code is to establish provisions that shall be satisfied to ensure safety and to protect people, property and the environment from harmful effects of ionizing radiation during the transport of radioactive material. This protection is achieved by requiring:

- .1 containment of the radioactive contents;
- .2 control of external dose rate;
- .3 prevention of criticality; and
- .4 prevention of damage caused by heat.

These provisions are satisfied firstly by applying a graded approach to contents limits for packages and conveyances and to performance standards applied to package designs depending upon the hazard of the radioactive contents. Secondly, they are satisfied by imposing conditions on the design and operation of packages and on the maintenance of packagings, including a consideration of the nature of the radioactive contents. Thirdly, they are satisfied by requiring administrative controls including, where appropriate, approval by competent authorities. Finally, further protection is provided by making arrangements for planning and preparing emergency response to protect people, property and the environment.

1.5.1.3 The provisions of this Code apply to the transport of radioactive material by sea, including transport which is incidental to the use of the radioactive material. Transport comprises all operations and conditions associated with and involved in the movement of radioactive material; these include the design, manufacture, maintenance and repair of packaging, and the preparation, consigning, loading, transport including in-transit storage, unloading and receipt at the final destination of loads of radioactive material and packages. A graded approach is applied to the performance standards in the provisions of this Code that are characterized by three general severity levels:

- .1 routine conditions of transport (incident-free);
- .2 normal conditions of transport (minor mishaps); and
- .3 accident conditions of transport.

1.5.1.4 The provisions of this Code do not apply to any of the following:

- .1 radioactive material that is an integral part of the means of transport;
- .2 radioactive material moved within an establishment which is subject to appropriate safety regulations in force in the establishment and where the movement does not involve public roads or railways;
- .3 radioactive material implanted or incorporated into a person or live animal for diagnosis or treatment;
- .4 radioactive material in or on a person who is to be transported for medical treatment because the person has been subject to accidental or deliberate intake of radioactive material or to contamination;
- .5 radioactive material in consumer products which have received regulatory approval, following their sale to the end user;
- .6 natural material and ores containing naturally occurring radionuclides (which may have been processed), provided the activity concentration of the material does not exceed 10 times the values specified in table 2.7.2.2.1, or calculated in accordance with 2.7.2.2.1 and 2.7.2.2.3 to 2.7.2.2.6. For natural materials

## 1 Part 1 – General provisions, definitions and training

and ores containing naturally occurring radionuclides that are not in secular equilibrium the calculation of the activity concentration shall be performed in accordance with 2.7.2.2.4; and

- .7 non-radioactive solid objects with radioactive substances present on any surfaces in quantities not in excess of the limit set out in the definition for “contamination” in 2.7.1.2.

### 1.5.1.5 Specific provisions for the transport of excepted packages

1.5.1.5.1 Excepted packages which may contain radioactive material in limited quantities, instruments, manufactured articles or empty packagings as specified in 2.7.2.4.1 shall be subject only to the following provisions of parts 5 to 7:

- .1 the applicable provisions specified in 5.1.1.2, 5.1.2, 5.1.3.2, 5.1.5.2.2, 5.1.5.2.3, 5.1.5.4, 5.1.5.5, 5.2.1.7, 5.4.1.5.7.1.6.1 and .2, 5.4.1.5.7.1.9, 7.1.4.5.9, 7.1.4.5.10, 7.1.4.5.12, 7.8.4.1 to 7.8.4.6 and 7.8.9.1,
- .2 the requirements for excepted packages specified in 6.4.4;

except when the radioactive material possesses other hazardous properties and has to be classified in a class other than class 7 in accordance with special provision 290 or 369 of chapter 3.3, where the provisions listed in .1 and .2 above apply only as relevant and in addition to those relating to the main class or division.

1.5.1.5.2 Excepted packages shall be subject to the relevant provisions of all other parts of this Code.

### 1.5.2 Radiation protection programme

1.5.2.1 The transport of radioactive material shall be subject to a radiation protection programme which shall consist of systematic arrangements aimed at providing adequate consideration of radiation protection measures.

1.5.2.2 Doses to persons shall be below the relevant dose limits. Protection and safety shall be optimized in order that the magnitude of individual doses, the number of persons exposed, and the likelihood of incurring exposure shall be kept as low as reasonably achievable, economic and social factors being taken into account, within the restrictions that the doses to individuals be subject to dose constraints. A structured and systematic approach shall be adopted and shall include consideration of the interfaces between transport and other activities.

1.5.2.3 The nature and extent of the measures to be employed in the programme shall be related to the magnitude and likelihood of radiation exposures. The programme shall incorporate the provisions in 1.5.2.2, 1.5.2.4 and 7.1.4.5.13 to 7.1.4.5.18. Programme documents shall be available, on request, for inspection by the relevant competent authority.

1.5.2.4 For occupational exposures arising from transport activities, where it is assessed that the effective dose either:

- .1 is likely to be between 1 and 6 mSv in a year, a dose assessment programme via workplace monitoring or individual monitoring shall be conducted; or
- .2 is likely to exceed 6 mSv in a year, individual monitoring shall be conducted.

When workplace monitoring or individual monitoring is conducted, appropriate records shall be kept.

**Note:** For occupational exposures arising from transport activities, where it is assessed that the effective dose is most unlikely to exceed 1 mSv in a year, no special work patterns, detailed monitoring, dose assessment programmes or individual record keeping need be required.

### 1.5.3 Management system

1.5.3.1 A management system based on international, national or other standards acceptable to the competent authority shall be established and implemented for all activities within the scope of this Code, as identified in 1.5.1.3, to ensure compliance with the relevant provisions of this Code. Certification that the design specification has been fully implemented shall be available to the competent authority. The manufacturer, consignor or user shall be prepared:

- .1 to provide facilities for inspection during manufacture and use; and
- .2 to demonstrate compliance with this Code to the competent authority.

Where competent authority approval is required, such approval shall take into account and be contingent upon the adequacy of the management system.

## 1.5.4 Special arrangement

1.5.4.1 *Special arrangement* shall mean those provisions, approved by the competent authority, under which consignments which do not satisfy all the provisions of this Code applicable to radioactive material may be transported.

1.5.4.2 Consignments for which conformity with any provision applicable to radioactive material is impracticable shall not be transported except under special arrangement. Provided the competent authority is satisfied that conformity with the radioactive material provisions of this Code is impracticable and that the requisite standards of safety established by this Code have been demonstrated through means alternative to the other provisions of this Code, the competent authority may approve special arrangement transport operations for a single consignment or a planned series of multiple consignments. The overall level of safety in transport shall be at least equivalent to that which would be provided if all the applicable provisions in this Code had been met. For international consignments of this type, multilateral approval shall be required.

## 1.5.5 Radioactive material possessing other dangerous properties

1.5.5.1 In addition to the radioactive and fissile properties, any subsidiary hazard of the contents of a package, such as explosiveness, flammability, pyrophoricity, chemical toxicity and corrosiveness, shall also be taken into account in the documentation, packing, labelling, marking, placarding, stowage, segregation and transport, in order to be in compliance with all relevant provisions for dangerous goods. (See also special provision 172 and, for excepted packages, special provision 290.)

## 1.5.6 Non-compliance

1.5.6.1 In the event of non-compliance with any limit in the provisions of this Code applicable to dose rate or contamination,

- .1 the consignor, carrier, consignee and any organization involved during transport who may be affected, as appropriate, shall be informed of the non-compliance:
  - .1 by the carrier if the non-compliance is identified during transport; or
  - .2 by the consignee if the non-compliance is identified at receipt;
- .2 the consignor, carrier, or consignee, as appropriate, shall:
  - .1 take immediate steps to mitigate the consequences of the non-compliance;
  - .2 investigate the non-compliance and its causes, circumstances and consequences;
  - .3 take appropriate action to remedy the causes and circumstances that led to the non-compliance and to prevent a recurrence of the causes and circumstances similar to those that led to the non-compliance; and
  - .4 communicate to the relevant competent authority(ies) on the causes of the non-compliance and the corrective or preventive actions taken or to be taken;
- .3 The communication of the non-compliance to the consignor and relevant competent authority(ies), respectively, shall be made as soon as practicable and it shall be immediate whenever an emergency exposure situation has developed or is developing.





# **PART 2**

## **CLASSIFICATION**



## Chapter 2.0

### Introduction

**Note:** For the purposes of this Code, it has been necessary to classify dangerous goods in different classes, to subdivide a number of these classes and to define and describe characteristics and properties of the substances, materials and articles which would fall within each class or division. Moreover, in accordance with the criteria for the selection of marine pollutants for the purposes of Annex III of the International Convention for the Prevention of Pollution from Ships, 1973, as modified by the Protocol of 1978 relating thereto (MARPOL), a number of dangerous substances in the various classes have also been identified as substances harmful to the marine environment (MARINE POLLUTANTS).

#### 2.0.0 Responsibilities

2.0.0.1 The classification shall be made by the shipper/consignor or by the appropriate competent authority where specified in this Code.

2.0.0.2 A consignor who has identified, on the basis of test data, that a substance listed by name in column 2 of the Dangerous Goods List in chapter 3.2 meets classification criteria for a hazard class or division that is not identified in the list, may, with the approval of the competent authority, consign the substance:

- under the most appropriate "generic" or "not otherwise specified" (N.O.S.) entry reflecting all hazards; or
- under the same UN number and name but with additional hazard communication information as appropriate to reflect the additional subsidiary hazard(s) (documentation, label, placard) provided that the primary hazard class remains unchanged and that any other transport conditions (e.g. limited quantity, packaging and tank provisions) that would normally apply to substances possessing such a combination of hazards are the same as those applicable to the substance listed.

**Note:** When a competent authority grants such approvals, it should inform the United Nations Sub-Committee of Experts on the Transport of Dangerous Goods accordingly and submit a relevant proposal of amendment to the Dangerous Goods List. Should the proposed amendment be rejected, the competent authority should withdraw its approval.

#### 2.0.1 Classes, divisions, packing groups

##### 2.0.1.1 Definitions

Substances (including mixtures and solutions) and articles subject to the provisions of this Code are assigned to one of the classes 1–9 according to the hazard or the most predominant of the hazards they present. Some of these classes are subdivided into divisions. These classes or divisions are as listed below:

Class 1: Explosives

- Division 1.1: substances and articles which have a mass explosion hazard
- Division 1.2: substances and articles which have a projection hazard but not a mass explosion hazard
- Division 1.3: substances and articles which have a fire hazard and either a minor blast hazard or a minor projection hazard or both, but not a mass explosion hazard
- Division 1.4: substances and articles which present no significant hazard
- Division 1.5: very insensitive substances which have a mass explosion hazard
- Division 1.6: extremely insensitive articles which do not have a mass explosion hazard

Class 2: Gases

- Class 2.1: flammable gases
- Class 2.2: non-flammable, non-toxic gases
- Class 2.3: toxic gases

Class 3: Flammable liquids



**Part 2 – Classification**

Class 4: Flammable solids; substances liable to spontaneous combustion; substances which, in contact with water, emit flammable gases

Class 4.1: flammable solids, self-reactive substances, solid desensitized explosives and polymerizing substances

Class 4.2: substances liable to spontaneous combustion

Class 4.3: substances which, in contact with water, emit flammable gases

Class 5: Oxidizing substances and organic peroxides

Class 5.1: oxidizing substances

Class 5.2: organic peroxides

Class 6: Toxic and infectious substances

Class 6.1: toxic substances

Class 6.2: infectious substances

Class 7: Radioactive material

Class 8: Corrosive substances

Class 9: Miscellaneous dangerous substances and articles

The numerical order of the classes and divisions is not that of the degree of danger.

**2.0.1.2 Marine pollutants**

2.0.1.2.1 Many of the substances assigned to classes 1 to 6.2, 8 and 9 are deemed as being *marine pollutants* (see chapter 2.10).

2.0.1.2.2 Known marine pollutants are noted in the Dangerous Goods List and are indicated in the Index.

2.0.1.3 For packing purposes, substances other than those of classes 1, 2, 5.2, 6.2 and 7, and other than self-reactive substances of class 4.1, are assigned to three packing groups in accordance with the degree of danger they present:

Packing group I: substances presenting high danger;

Packing group II: substances presenting medium danger; and

Packing group III: substances presenting low danger.

The packing group to which a substance is assigned is indicated in the Dangerous Goods List in chapter 3.2.

Articles are not assigned to packing groups. For packing purposes, any requirement for a specific packaging performance level is set out in the applicable packing instruction.

2.0.1.4 Dangerous goods are determined to present one or more of the dangers represented by classes 1 to 9, marine pollutants and, if applicable, the degree of danger (packing group) on the basis of the provisions in chapters 2.1 to 2.10.

2.0.1.5 Dangerous goods presenting a danger of a single class or division are assigned to that class or division and the packing group, if applicable, determined. When an article or substance is specifically listed by name in the Dangerous Goods List in chapter 3.2, its class or division, its subsidiary hazard(s) and, when applicable, its packing group are taken from this list.

2.0.1.6 Dangerous goods meeting the defining criteria of more than one hazard class or division and which are not listed by name in the Dangerous Goods List are assigned to a class or division and subsidiary hazard(s) on the basis of the precedence of hazard provisions prescribed in 2.0.3.

**2.0.2 UN numbers and proper shipping names**

2.0.2.1 Dangerous goods are assigned to UN numbers and proper shipping names according to their hazard classification and their composition.

2.0.2.2 Dangerous goods commonly transported are listed in the Dangerous Goods List in chapter 3.2. Where an article or substance is specifically listed by name, it shall be identified in transport by the proper shipping name in the Dangerous Goods List. Such substances may contain technical impurities (for example those deriving from the production process) or additives for stability or other purposes that do not affect their classification. However, a substance listed by name containing technical impurities or additives for stability or other purposes affecting its classification shall be considered a mixture or solution (see 2.0.2.5). For dangerous goods not specifically listed by name, “generic” or “not otherwise specified” entries are provided (see 2.0.2.7) to identify the article or substance in transport. The substances listed by name in column (2) of the Dangerous Goods List of chapter 3.2 shall be transported according to their classification in the list or under the conditions specified in 2.0.0.2.

Each entry in the Dangerous Goods List is assigned a UN number. This list also contains relevant information for each entry, such as hazard class, subsidiary hazard(s) (if any), packing group (where assigned), packing and tank transport provisions, EmS, segregation and stowage, properties and observations, etc.

Entries in the Dangerous Goods List are of the following four types:

- .1 single entries for well-defined substances or articles:  
e.g. UN 1090 acetone  
UN 1194 ethyl nitrite solution
- .2 generic entries for well-defined groups of substances or articles:  
e.g. UN 1133 adhesives  
UN 1266 perfumery product  
UN 2757 carbamate pesticide, solid, toxic  
UN 3101 organic peroxide type B, liquid
- .3 specific N.O.S. entries covering a group of substances or articles of a particular chemical or technical nature:  
e.g. UN 1477 nitrates, inorganic, N.O.S.  
UN 1987 alcohols, N.O.S.
- .4 general N.O.S. entries covering a group of substances or articles meeting the criteria of one or more classes:  
e.g. UN 1325 flammable solid, organic, N.O.S.  
UN 1993 flammable liquid, N.O.S.

2.0.2.3 All self-reactive substances of class 4.1 are assigned to one of 20 generic entries in accordance with the classification principles described in 2.4.2.3.3.

2.0.2.4 All organic peroxides of class 5.2 are assigned to one of 20 generic entries in accordance with the classification principles described in 2.5.3.3.

2.0.2.5 A mixture or solution meeting the classification criteria of this Code composed of a single predominant substance identified by name in the Dangerous Goods List and one or more substances not subject to the provisions of this Code and/or traces of one or more substances identified by name in the Dangerous Goods List, shall be assigned the UN number and proper shipping name of the predominant substance named in the Dangerous Goods List unless:

- .1 the mixture or solution is identified by name in the Dangerous Goods List;
- .2 the name and description of the substance named in the Dangerous Goods List specifically indicate that they apply only to the pure substance;
- .3 the hazard class or division, subsidiary hazard(s), packing group, or physical state of the mixture or solution is different from that of the substance named in the Dangerous Goods List; or
- .4 the hazard characteristics and properties of the mixture or solution necessitate emergency response measures that are different from those required for the substance identified by name in the Dangerous Goods List.

In those other cases, except the one described in .1, the mixture or solution shall be treated as a dangerous substance not specifically listed by name in the Dangerous Goods List.

2.0.2.6 When the class, physical state or packing group has changed in comparison with the pure substance, the solution or mixture shall be shipped in accordance with the provisions for the changed hazard under an appropriate N.O.S. entry.

2.0.2.7 Substances or articles which are not specifically listed by name in the Dangerous Goods List shall be classified under a “generic” or “not otherwise specified” (N.O.S.) proper shipping name. The substance or article shall be classified according to the class definitions and test criteria in this part, and the article or substance classified under the generic or “N.O.S.” proper shipping name in the Dangerous Goods List which most appropriately describes the article or substance. This means that a substance is only to be assigned to an entry of type .3, as defined in 2.0.2.2, if it cannot be assigned to an entry of type .2, and to an entry of type .4 if it cannot be assigned to an entry of type .2 or .3.\*

2.0.2.8 When considering a solution or mixture in accordance with 2.0.2.5, due account shall be given to whether the dangerous constituent comprising the solution or mixture has been identified as a marine pollutant. If this is the case, the provisions of chapter 2.10 are also applicable.

\* See also the generic or N.O.S. proper shipping name in appendix A.

Part 2 – Classification

2.0.2.9 A mixture or solution, containing one or more substances identified by name in this Code or classified under an N.O.S. or generic entry and one or more substances not subject to the provisions of this Code, is not subject to the provisions of this Code if the hazard characteristics of the mixture or solution are such that they do not meet the criteria (including human experience criteria) for any class.

2.0.2.10 A mixture or solution meeting the classification criteria of this Code that is not identified by name in the Dangerous Goods List and that is composed of two or more dangerous goods shall be assigned to an entry that has the proper shipping name, description, hazard class or division, subsidiary hazard(s) and packing group that most precisely describe the mixture or solution.

**2.0.3 Classification of substances, mixtures and solutions with multiple hazards (precedence of hazard characteristics)**

2.0.3.1 The table of precedence of hazard characteristics in 2.0.3.6 shall be used to determine the class of a substance, mixture or solution having more than one hazard when it is not specifically listed by name in this Code or to assign the appropriate entry for articles containing dangerous goods N.O.S. (UN 3537 to 3548, see 2.0.6). For substances, mixtures or solutions having multiple hazards which are not specifically listed by name, the most stringent packing group of those assigned to the respective hazards of the goods takes precedence over other packing groups, irrespective of the precedence of hazard table in 2.0.3.6.

2.0.3.2 The precedence of hazard table indicates which of the hazards shall be regarded as the primary hazard. The class which appears at the intersection of the horizontal line and the vertical column is the primary hazard and the remaining class is the subsidiary hazard. The packing groups for each of the hazards associated with the substance, mixture or solution shall be determined by reference to the appropriate criteria. The most stringent of the groups so indicated shall then become the packing group of the substance, mixture or solution.

2.0.3.3 The proper shipping name (see 3.1.2) of a substance, mixture or solution when classified in accordance with 2.0.3.1 and 2.0.3.2 shall be the most appropriate N.O.S. (“not otherwise specified”) entry in this Code for the class shown as the primary hazard.

2.0.3.4 The precedence of hazard characteristics of the following substances, materials and articles have not been dealt with in the precedence of hazard table, as these primary hazards always take precedence:

- .1 substances and articles of class 1;
- .2 gases of class 2;
- .3 liquid desensitized explosives of class 3;
- .4 self-reactive substances and solid desensitized explosives of class 4.1;
- .5 pyrophoric substances of class 4.2;
- .6 substances of class 5.2;
- .7 substances of class 6.1 with a packing group I vapour inhalation toxicity;
- .8 substances of class 6.2; and
- .9 materials of class 7.

2.0.3.5 Apart from excepted radioactive material (where the other hazardous properties take precedence), radioactive material having other hazardous properties shall always be classified in class 7, with the greatest of the additional hazards being identified. For radioactive material in excepted packages, except for UN 3507, URANIUM HEXAFLUORIDE, RADIOACTIVE MATERIAL, EXCEPTED PACKAGE, special provision 290 of chapter 3.3 applies.

**2.0.3.6 Precedence of hazards**

| Class and Packing Group | 4.2 | 4.3 | 5.1 I | 5.1 II | 5.1 III | 6.1, I Dermal | 6.1, I Oral | 6.1 II | 6.1 III        | 8, I Liquid | 8, I Solid | 8, II Liquid | 8, II Solid | 8, III Liquid | 8, III Solid |
|-------------------------|-----|-----|-------|--------|---------|---------------|-------------|--------|----------------|-------------|------------|--------------|-------------|---------------|--------------|
| 3 I*                    |     | 4.3 |       |        |         | 3             | 3           | 3      | 3              | 3           | –          | 3            | –           | 3             | –            |
| 3 II*                   |     | 4.3 |       |        |         | 3             | 3           | 3      | 3              | 8           | –          | 3            | –           | 3             | –            |
| 3 III*                  |     | 4.3 |       |        |         | 6.1           | 6.1         | 6.1    | 3 <sup>†</sup> | 8           | –          | 8            | –           | 3             | –            |
| 4.1 II*                 | 4.2 | 4.3 | 5.1   | 4.1    | 4.1     | 6.1           | 6.1         | 4.1    | 4.1            | –           | 8          | –            | 4.1         | –             | 4.1          |
| 4.1 III*                | 4.2 | 4.3 | 5.1   | 4.1    | 4.1     | 6.1           | 6.1         | 6.1    | 4.1            | –           | 8          | –            | 8           | –             | 4.1          |
| 4.2 II                  |     | 4.3 | 5.1   | 4.2    | 4.2     | 6.1           | 6.1         | 4.2    | 4.2            | 8           | 8          | 4.2          | 4.2         | 4.2           | 4.2          |
| 4.2 III                 |     | 4.3 | 5.1   | 5.1    | 4.2     | 6.1           | 6.1         | 6.1    | 4.2            | 8           | 8          | 8            | 8           | 4.2           | 4.2          |
| 4.3 I                   |     |     | 5.1   | 4.3    | 4.3     | 6.1           | 4.3         | 4.3    | 4.3            | 4.3         | 4.3        | 4.3          | 4.3         | 4.3           | 4.3          |
| 4.3 II                  |     |     | 5.1   | 4.3    | 4.3     | 6.1           | 4.3         | 4.3    | 4.3            | 8           | 8          | 4.3          | 4.3         | 4.3           | 4.3          |

| Class and Packing Group | 4.2 | 4.3 | 5.1 I | 5.1 II | 5.1 III | 6.1, I Dermal | 6.1, I Oral | 6.1 II | 6.1 III | 8, I Liquid | 8, I Solid | 8, II Liquid | 8, II Solid | 8, III Liquid | 8, III Solid |
|-------------------------|-----|-----|-------|--------|---------|---------------|-------------|--------|---------|-------------|------------|--------------|-------------|---------------|--------------|
| 4.3 III                 |     |     | 5.1   | 5.1    | 4.3     | 6.1           | 6.1         | 6.1    | 4.3     | 8           | 8          | 8            | 8           | 4.3           | 4.3          |
| 5.1 I                   |     |     |       |        |         | 5.1           | 5.1         | 5.1    | 5.1     | 5.1         | 5.1        | 5.1          | 5.1         | 5.1           | 5.1          |
| 5.1 II                  |     |     |       |        |         | 6.1           | 5.1         | 5.1    | 5.1     | 8           | 8          | 5.1          | 5.1         | 5.1           | 5.1          |
| 5.1 III                 |     |     |       |        |         | 6.1           | 6.1         | 6.1    | 5.1     | 8           | 8          | 8            | 8           | 5.1           | 5.1          |
| 6.1 I, Dermal           |     |     |       |        |         |               |             |        |         | 8           | 6.1        | 6.1          | 6.1         | 6.1           | 6.1          |
| 6.1 I, Oral             |     |     |       |        |         |               |             |        |         | 8           | 6.1        | 6.1          | 6.1         | 6.1           | 6.1          |
| 6.1 II, Inhalation      |     |     |       |        |         |               |             |        |         | 8           | 6.1        | 6.1          | 6.1         | 6.1           | 6.1          |
| 6.1 II, Dermal          |     |     |       |        |         |               |             |        |         | 8           | 6.1        | 8            | 6.1         | 6.1           | 6.1          |
| 6.1 II, Oral            |     |     |       |        |         |               |             |        |         | 8           | 8          | 8            | 6.1         | 6.1           | 6.1          |
| 6.1 III                 |     |     |       |        |         |               |             |        |         | 8           | 8          | 8            | 8           | 8             | 8            |

\* Substances of class 4.1 other than self-reactive substances and solid desensitized explosives and substances of class 3 other than liquid desensitized explosives.

† 6.1 for pesticides.

– Denotes an impossible combination.

For hazards not shown in this table, see 2.0.3.4 and 2.0.3.5.

## 2.0.4 Transport of samples

2.0.4.1 When the hazard class of a substance is uncertain and it is being transported for further testing, a tentative hazard class, proper shipping name and identification number shall be assigned on the basis of the consignor's knowledge of the substances and application of:

- .1 the classification criteria of this Code; and
- .2 the precedence of hazards given in 2.0.3.

The most severe packing group possible for the proper shipping name chosen shall be used.

Where this provision is used, the proper shipping name shall be supplemented with the word "SAMPLE" (such as FLAMMABLE LIQUID, N.O.S., SAMPLE). In certain instances, where a specific proper shipping name is provided for a sample of a substance considered to meet certain classification criteria (such as UN 3167, GAS SAMPLE, NON-PRESSURIZED, FLAMMABLE), that proper shipping name shall be used. When an N.O.S. entry is used to transport the sample, the proper shipping name need not be supplemented with the technical name as required by special provision 274.

2.0.4.2 Samples of the substance shall be transported in accordance with the provisions applicable to the tentative assigned proper shipping name provided:

- .1 the substance is not considered to be a substance prohibited for transport by 1.1.3;
- .2 the substance is not considered to meet the criteria for class 1 or considered to be an infectious substance or a radioactive material;
- .3 the substance is in compliance with 2.4.2.3.2.4.2 or 2.5.3.2.5.1 if it is a self-reactive substance or an organic peroxide, respectively;
- .4 the sample is transported in a combination packaging with a net mass per package not exceeding 2.5 kg; and
- .5 the sample is not packed together with other goods.

### 2.0.4.3 Samples of energetic materials for testing purposes

2.0.4.3.1 Samples of organic substances carrying functional groups listed in tables A6.1 and/or A6.3 in appendix 6 (Screening Procedures) of the *Manual of Tests and Criteria* may be transported under UN 3224 (self-reactive solid type C) or UN 3223 (self-reactive liquid type C), as applicable, of class 4.1 provided that:

- .1 the samples do not contain any:
  - known explosives;
  - substances showing explosive effects in testing;
  - compounds designed with the view of producing a practical explosive or pyrotechnic effect; or
  - components consisting of synthetic precursors of intentional explosives;

**Part 2 – Classification**

- .2 for mixtures, complexes or salts of inorganic oxidizing substances of class 5.1 with organic material(s), the concentration of the inorganic oxidizing substance is:
  - less than 15%, by mass, if assigned to packing group I (high hazard) or II (medium hazard); or
  - less than 30%, by mass, if assigned to packing group III (low hazard);
- .3 available data do not allow a more precise classification;
- .4 the sample is not packed together with other goods; and
- .5 the sample is packed in accordance with packing instruction P520 and special packing provisions PP94 or PP95 of 4.1.4.1, as applicable.

**2.0.5 Transport of wastes****2.0.5.1 Preamble**

Wastes, which are dangerous goods, shall be transported in accordance with the relevant international recommendations and conventions and, in particular, where it concerns transport by sea, with the provisions of this Code.

**2.0.5.2 Applicability**

2.0.5.2.1 The provisions of this chapter are applicable to the transport of wastes by ships and shall be considered in conjunction with all other provisions of this Code.

2.0.5.2.2 Substances, solutions, mixtures or articles containing or contaminated with radioactive material are subject to the applicable provisions for radioactive material in class 7, and are not to be considered as wastes for the purposes of this chapter.

**2.0.5.3 Transboundary movements under the Basel Convention\***

2.0.5.3.1 Transboundary movement of wastes is permitted to commence only when:

- .1 notification has been sent by the competent authority of the country of origin, or by the generator or exporter through the channel of the competent authority of the country of origin, to the country of final destination; and
- .2 the competent authority of the country of origin, having received the written consent of the country of final destination stating that the wastes will be safely incinerated or treated by other methods of disposal, has given authorization to the movement.

2.0.5.3.2 In addition to the transport document required in chapter 5.4, all transboundary movements of wastes shall be accompanied by a waste movement document from the point at which a transboundary movement commences to the point of disposal. This document shall be available at all times to the competent authorities and to all persons involved in the management of waste transport operations.

2.0.5.3.3 The transport of solid wastes in bulk in cargo transport units and road vehicles is only permitted with the approval of the competent authority of the country of origin.

2.0.5.3.4 In the event that packages and cargo transport units containing wastes are suffering from leakage or spillage, the competent authorities of the countries of origin and destination shall be immediately informed and advice on the action to be taken obtained from them.

**2.0.5.4 Classification of wastes**

2.0.5.4.1 A waste containing only one constituent which is a dangerous substance subject to the provisions of this Code shall be regarded as being that particular substance. If the concentration of the constituent is such that the waste continues to present a hazard inherent in the constituent itself, it shall be classified according to the criteria of the applicable classes.

2.0.5.4.2 A waste containing two or more constituents which are dangerous substances subject to the provisions of this Code shall be classified under the applicable class in accordance with their dangerous characteristics and properties as described in 2.0.5.4.3 and 2.0.5.4.4.

2.0.5.4.3 The classification according to the dangerous characteristics and properties shall be carried out as follows:

- .1 determination of the physical and chemical characteristics and physiological properties by measurement or calculation followed by classification according to the criteria of the applicable class(es); or

\* Basel Convention on the Control of Transboundary Movements of Hazardous Wastes and Their Disposal (1989).

- .2 if the determination is not practicable, the waste shall be classified according to the constituent presenting the predominant hazard.

2.0.5.4.4 In determining the predominant hazard, the following criteria shall be taken into account:

- .1 if one or more constituents fall within a certain class and the waste presents a hazard inherent in these constituents, the waste shall be included in that class; or
- .2 if there are constituents falling under two or more classes, the classification of the waste shall take into account the order of precedence applicable to dangerous substances with multiple hazards set out in 2.0.3.

2.0.5.4.5 Wastes harmful to the marine environment only shall be transported under the class 9 entries for ENVIRONMENTALLY HAZARDOUS SUBSTANCE, LIQUID, N.O.S., UN 3082, or ENVIRONMENTALLY HAZARDOUS SUBSTANCE, SOLID, N.O.S., UN 3077, with the addition of the word “WASTE”. However, this is not applicable to substances which are covered by individual entries in this Code.

2.0.5.4.6 Wastes not otherwise subject to the provisions of this Code but covered under the Basel Convention may be transported under the class 9 entries for ENVIRONMENTALLY HAZARDOUS SUBSTANCE, LIQUID, N.O.S., UN 3082 or ENVIRONMENTALLY HAZARDOUS SUBSTANCE, SOLID, N.O.S., UN 3077 with the addition of the word WASTE.

## 2.0.6 Classification of articles as articles containing dangerous goods, N.O.S.

**Note:** For articles which do not have an existing proper shipping name and which contain only dangerous goods within the permitted limited quantity amounts specified in column 7a of the Dangerous Goods List, see UN 3363 and special provision 301 of chapter 3.3.

2.0.6.1 Articles containing dangerous goods may be classified as otherwise provided by this Code under the proper shipping name for the dangerous goods they contain or in accordance with this section. For the purposes of this section “article” means machinery, apparatus or other devices containing one or more dangerous goods (or residues thereof) that are an integral element of the article, necessary for its functioning, and that cannot be removed for the purpose of transport. An inner packaging shall not be an article.

△ 2.0.6.2 Such articles may in addition contain cells or batteries. Lithium cells and batteries that are integral to the article shall be of a type proven to meet the testing requirements of the Manual of Tests and Criteria, part III, subsection 38.3. For articles containing pre-production prototype lithium cells or batteries transported for testing, or for articles containing lithium cells or batteries manufactured in production runs of not more than 100 cells or batteries, the requirements of special provision 310 of chapter 3.3 shall apply. Where a lithium battery installed in an article is damaged or defective, the battery shall be removed.

2.0.6.3 This section does not apply to articles for which a more specific proper shipping name already exists in the Dangerous Goods List of chapter 3.2.

2.0.6.4 This section does not apply to dangerous goods of class 1, class 6.2, class 7 or radioactive material contained in articles. However, this section applies to articles containing explosives which are excluded from Class 1 in accordance with 2.1.3.4.2.

2.0.6.5 Articles containing dangerous goods shall be assigned to the appropriate class determined by the hazards present using, where applicable, the Precedence of Hazards table in 2.0.3.6 for each of the dangerous goods contained in the article. If dangerous goods classified as class 9 are contained within the article, all other dangerous goods present in the article shall be considered to present a higher hazard.

2.0.6.6 Subsidiary hazards shall be representative of the primary hazard posed by the other dangerous goods contained within the article. When only one dangerous good is present in the article, the subsidiary hazard(s), if any, shall be the subsidiary hazard(s) identified in column 4 of the Dangerous Goods List. If the article contains more than one dangerous good and these could react dangerously with one another during transport, each of the dangerous goods shall be enclosed separately (see 4.1.1.6).



## Chapter 2.1

### Class 1 – Explosives

#### 2.1.0 Introductory notes (these notes are not mandatory)

- Note 1:** Class 1 is a restricted class, that is, only those explosive substances and articles that are listed in the Dangerous Goods List in chapter 3.2 may be accepted for transport. However, the competent authorities retain the right by mutual agreement to approve transport of explosive substances and articles for special purposes under special conditions. Therefore entries have been included in the Dangerous Goods List for “Substances, explosive, not otherwise specified” and “Articles, explosive, not otherwise specified”. It is intended that these entries should only be used when no other method of operation is possible.
- Note 2:** General entries such as “Explosive, blasting, type A” are used to allow for the transport of new substances. In preparing these provisions, military ammunition and explosives have been taken into consideration to the extent that they are likely to be transported by commercial carriers.
- Note 3:** A number of substances and articles in class 1 are described in appendix B. These descriptions are given because a term may not be well-known or may be at variance with its usage for regulatory purposes.
- Note 4:** Class 1 is unique in that the type of packaging frequently has a decisive effect on the hazard and therefore on the assignment to a particular division. The correct division is determined by use of the procedures provided in this chapter.

#### 2.1.1 Definitions and general provisions

##### 2.1.1.1 Class 1 comprises:

- .1 explosive substances (a substance which is not itself an explosive but which can form an explosive atmosphere of gas, vapour or dust is not included in class 1), except those which are too dangerous to transport or those where the predominant hazard is one appropriate to another class;
- .2 explosive articles, except devices containing explosive substances in such quantity or of such a character that their inadvertent or accidental ignition or initiation during transport shall not cause any effect external to the device either by projection, fire, smoke, heat or loud noise (see 2.1.3.4); and
- .3 substances and articles not mentioned under .1 and .2 which are manufactured with a view to producing a practical explosive or pyrotechnic effect.

2.1.1.2 Transport of explosive substances which are unduly sensitive, or so reactive as to be subject to spontaneous reaction, is prohibited.

##### 2.1.1.3 Definitions

For the purposes of this Code, the following definitions apply:

- .1 *Explosive substance* means a solid or liquid substance (or a mixture of substances) which is in itself capable by chemical reaction of producing gas at such a temperature and pressure and at such a speed as to cause damage to the surroundings. Pyrotechnic substances are included even when they do not evolve gases.
- △ .2 *Pyrotechnic substance* means an explosive substance designed to produce an effect by heat, light, sound, gas or smoke or a combination of these as the result of non-detonative self-sustaining exothermic chemical reactions.
- .3 *Explosive article* means an article containing one or more explosive substances.
- .4 *Mass explosion* means one which affects almost the entire load virtually instantaneously.
- .5 *Phlegmatized* means that a substance (or “phlegmatizer”) has been added to an explosive to enhance its safety in handling and transport. The phlegmatizer renders the explosive insensitive, or less sensitive, to the following actions: heat, shock, impact, percussion or friction. Typical phlegmatizing agents include, but are not limited to: wax, paper, water, polymers (such as chlorofluoropolymers), alcohol and oils (such as petroleum jelly and paraffin).

- .6 *Explosive or pyrotechnic effect* means, in the context of 2.1.1.1.3, an effect produced by self-sustaining exothermic chemical reactions including shock, blast, fragmentation, projection, heat, light, sound, gas and smoke.

#### 2.1.1.4 Hazard divisions

The six hazard divisions of class 1 are:

Division 1.1 Substances and articles which have a mass explosion hazard

Division 1.2 Substances and articles which have a projection hazard but not a mass explosion hazard

Division 1.3 Substances and articles which have a fire hazard and either a minor blast hazard or a minor projection hazard or both, but not a mass explosion hazard

This division comprises substances and articles:

- .1 which give rise to considerable radiant heat; or
- .2 which burn one after another, producing minor blast or projection effects or both.

Division 1.4 Substances and articles which present no significant hazard

This division comprises substances and articles which present only a small hazard in the event of ignition or initiation during transport. The effects are largely confined to the package and no projection of fragments of appreciable size or range is to be expected. An external fire must not cause virtually instantaneous explosion of almost the entire contents of the package.

**Note:** Substances and articles in this division are in compatibility group S if they are so packaged or designed that any hazardous effects arising from the accidental functioning are confined within the package unless the package has been degraded by fire, in which case all blast or projection effects are limited to the extent that they do not significantly hinder fire fighting or other emergency response efforts in the immediate vicinity of the package.

Division 1.5 Very insensitive substances which have a mass explosion hazard

This division comprises substances which have a mass explosion hazard but are so insensitive that there is very little probability of initiation or of transition from burning to detonation under normal conditions of transport.

**Note:** The probability of transition from burning to detonation is greater when large quantities are transported in a ship. As a consequence, the stowage provisions for explosive substances in division 1.1 and for those in division 1.5 are identical.

Division 1.6 Extremely insensitive articles which do not have a mass explosion hazard

This division comprises articles which predominantly contain extremely insensitive substances and which demonstrate a negligible probability of accidental initiation or propagation.

**Note:** The hazard from articles of division 1.6 is limited to the explosion of a single article.

2.1.1.5 Any substance or article having or suspected of having explosive characteristics shall first be considered for classification in class 1 in accordance with the procedures in 2.1.3. Goods are not classified in class 1 when:

- .1 unless specially authorized, the transport of an explosive substance is prohibited because sensitivity of the substance is excessive;
- .2 the substance or article comes within the scope of those explosive substances and articles which are specifically excluded from class 1 by the definition of this class; or
- .3 the substance or article has no explosive properties.

#### 2.1.2 Compatibility groups and classification codes

2.1.2.1 Goods of class 1 are considered to be “compatible” if they can be safely stowed or transported together without significantly increasing either the probability of an accident or, for a given quantity, the magnitude of the effects of such an accident. By this criterion, goods listed in this class have been divided into a number of compatibility groups, each denoted by a letter from A to L (excluding I), N and S. These are described in 2.1.2.2 and 2.1.2.3.



Part 2 – Classification

2.1.2.2 Compatibility groups and classification codes

| Description of substance or articles to be classified  | Compatibility group | Classification code          |
|--|---------------------|------------------------------|
| Primary explosive substance  | A                   | 1.1A                         |
| Article containing a primary explosive substance and not containing two or more effective protective features. Some articles, such as detonators for blasting, detonator assemblies for blasting and primers, cap-type, are included even though they do not contain primary explosives  | B                   | 1.1B<br>1.2B<br>1.4B         |
| Propellant explosive substance or other deflagrating explosive substance or article containing such explosive substance  | C                   | 1.1C<br>1.2C<br>1.3C<br>1.4C |
| Secondary detonating explosive substance or black powder or article containing a secondary detonating explosive substance, in each case without means of initiation and without a propelling charge, or article containing a primary explosive substance and containing two or more effective protective features  | D                   | 1.1D<br>1.2D<br>1.4D<br>1.5D |
| Article containing a secondary detonating explosive substance, without means of initiation, with a propelling charge (other than one containing a flammable liquid or gel or hypergolic liquids)   | E                   | 1.1E<br>1.2E<br>1.4E         |
| Article containing a secondary detonating explosive substance with its own means of initiation, with a propelling charge (other than one containing a flammable liquid or gel or hypergolic liquids) or without a propelling charge  | F                   | 1.1F<br>1.2F<br>1.3F<br>1.4F |
| Pyrotechnic substance, or article containing a pyrotechnic substance, or article containing both an explosive substance and an illuminating, incendiary, tear- or smoke-producing substance (other than a water-activated article or one containing white phosphorus, phosphides, a pyrophoric substance, a flammable liquid or gel, or hypergolic liquids)  | G                   | 1.1G<br>1.2G<br>1.3G<br>1.4G |
| Article containing both an explosive substance and white phosphorus  | H                   | 1.2H<br>1.3H                 |
| Article containing both an explosive substance and a flammable liquid or gel   | J                   | 1.1J<br>1.2J<br>1.3J         |
| Article containing both an explosive substance and a toxic chemical agent  | K                   | 1.2K<br>1.3K                 |
| Explosive substance or article containing an explosive substance and presenting a special hazard (such as due to water-activation or presence of hypergolic liquids, phosphides or a pyrophoric substance) and needing isolation of each type (see 7.2.7.1.4, note 2)  | L                   | 1.1L<br>1.2L<br>1.3L         |
| Articles predominantly containing extremely insensitive substances   | N                   | 1.6N                         |
| Substance or article so packaged or designed that any hazardous effects arising from accidental functioning are confined within the package unless the package has been degraded by fire, in which case all blast or projection effects are limited to the extent that they do not significantly hinder or prohibit fire fighting or other emergency response efforts in the immediate vicinity of the package | S                   | 1.4S                         |

**Note 1:** Articles of compatibility groups D and E may be fitted or packed together with their own means of initiation provided that such means have at least two effective protective features designed to prevent an explosion in the event of accidental functioning of the means of initiation. Such articles and packages shall be assigned to compatibility groups D or E.

**Note 2:** Articles of compatibility groups D and E may be packed together with their own means of initiation, which do not have two effective protective features when, in the opinion of the competent authority of the country of origin, the accidental functioning of the means of initiation does not cause the explosion of an article under normal conditions of transport. Such packages shall be assigned to compatibility groups D or E.

2.1.2.3 Scheme of classification of explosives, combination of hazard division with compatibility group

| Hazard division | Compatibility group |      |      |      |      |      |      |      |      |      |      |      |      | Σ A-S |
|-----------------|---------------------|------|------|------|------|------|------|------|------|------|------|------|------|-------|
|                 | A                   | B    | C    | D    | E    | F    | G    | H    | J    | K    | L    | N    | S    |       |
| 1.1             | 1.1A                | 1.1B | 1.1C | 1.1D | 1.1E | 1.1F | 1.1G |      | 1.1J |      | 1.1L |      |      | 9     |
| 1.2             |                     | 1.2B | 1.2C | 1.2D | 1.2E | 1.2F | 1.2G | 1.2H | 1.2J | 1.2K | 1.2L |      |      | 10    |
| 1.3             |                     |      | 1.3C |      |      | 1.3F | 1.3G | 1.3H | 1.3J | 1.3K | 1.3L |      |      | 7     |
| 1.4             |                     | 1.4B | 1.4C | 1.4D | 1.4E | 1.4F | 1.4G |      |      |      |      |      | 1.4S | 7     |
| 1.5             |                     |      |      | 1.5D |      |      |      |      |      |      |      |      |      | 1     |
| 1.6             |                     |      |      |      |      |      |      |      |      |      |      | 1.6N |      | 1     |
| Σ 1.1-1.6       | 1                   | 3    | 4    | 4    | 3    | 4    | 4    | 2    | 3    | 2    | 3    | 1    | 1    | 35    |

2.1.2.4 The definitions of compatibility groups in 2.1.2.2 are intended to be mutually exclusive, except for a substance or article which qualifies for compatibility group S. Since the criterion of compatibility group S is an empirical one, assignment to this group is necessarily linked to the tests for assignment to division 1.4.

2.1.3 Classification procedure

2.1.3.1 Any substance or article having or suspected of having explosive characteristics shall be considered for classification in class 1. Substances and articles classified in class 1 shall be assigned to the appropriate division and compatibility group. Goods of class 1 shall be classified in accordance with the *Manual of Tests and Criteria*, as amended.

2.1.3.2 Prior to transport, the classification of all explosive substances and articles, together with the compatibility group assignment and the proper shipping name under which the substance or article is to be transported, shall have been approved by the competent authority of the country of manufacture. A new approval would be required for:

- .1 a new explosive substance; or
- .2 a new combination or mixture of explosive substances which is significantly different from other combinations or mixtures previously manufactured and approved; or
- .3 a new design of an explosive article, an article containing a new explosive substance, or an article containing a new combination or mixture of explosive substances; or
- .4 an explosive substance or article with a new design or type of packaging, including a new type of inner packaging.

2.1.3.3 Assessment of the hazard division is usually made on the basis of test results. A substance or article shall be assigned to the hazard division which corresponds to the results of the tests to which the substance or article, as offered for transport, has been subjected. Other test results, and data assembled from accidents which have occurred, may also be taken into account.

2.1.3.4 Exclusion from class 1

2.1.3.4.1 The competent authority may exclude an article or substance from class 1 by virtue of test results and the class 1 definition.

2.1.3.4.2 An article may be excluded from class 1 by the competent authority when three unpackaged articles, each individually activated by its own means of initiation or ignition or external means to function in the designed mode, meet the following test criteria:

- .1 no external surface shall have a temperature of more than 65°C. A momentary spike in temperature up to 200°C is acceptable;
- .2 no rupture or fragmentation of the external casing or movement of the article or detached parts thereof of more than one metre in any direction;

**Note:** Where the integrity of the article may be affected in the event of an external fire these criteria shall be examined by a fire test. One such method is described in ISO 14451-2 using a heating rate of 80 K/min.

- .3 no audible report exceeding 135 dB(C) peak at a distance of one metre;
- .4 no flash or flame capable of igniting a material such as a sheet of 80 ± 10 g/m<sup>2</sup> paper in contact with the article; and

- .5 no production of smoke, fumes or dust in such quantities that the visibility in a one cubic metre chamber equipped with appropriately sized blow out panels is reduced more than 50% as measured by a calibrated light (lux) meter or radiometer located one metre from a constant light source located at the midpoint on opposite walls. The general guidance on Optical Density Testing in ISO 5659-1 and the general guidance on the Photometric System described in Section 7.5 in ISO 5659-2 may be used or similar optical density measurement methods designed to accomplish the same purpose may also be employed. A suitable hood cover surrounding the back and sides of the light meter shall be used to minimize effects of scattered or leaking light not emitted directly from the source.

**Note 1:** If during the tests addressing criteria .1, .2, .3 and .4 no or very little smoke is observed the test described in .5 may be waived.

**Note 2:** The competent authority may require testing in packaged form if it is determined that, as packaged for transport, the article may pose a greater hazard.

### 2.1.3.5 Assignment of fireworks to hazard divisions

2.1.3.5.1 Fireworks shall normally be assigned to hazard divisions 1.1, 1.2, 1.3, and 1.4 on the basis of test data derived from Test Series 6 of the *Manual of Tests and Criteria*. However:

- .1 waterfalls containing flash composition (see note 2 of 2.1.3.5.5) shall be classified as 1.1G regardless of the results of Test Series 6;
- .2 since the range of fireworks is very extensive and the availability of test facilities may be limited, assignment to hazard divisions may also be made in accordance with the procedure in 2.1.3.5.2.

2.1.3.5.2 Assignment of fireworks to UN Nos. 0333, 0334, 0335 or 0336, and assignments of articles to UN 0431 for those used for theatrical effects meeting the definition for article type and the 1.4G specification in the default fireworks classification table in 2.1.3.5.5 may be made on the basis of analogy, without the need for Test Series 6 testing, in accordance with the default fireworks classification table in 2.1.3.5.5. Such assignment shall be made with the agreement of the competent authority. Items not specified in the table shall be classified on the basis of test data derived from Test Series 6 of the *Manual of Tests and Criteria*.

**Note:** The addition of other types of fireworks to column 1 of the table in 2.1.3.5.5 shall only be made on the basis of full test data submitted to the UN Sub-Committee of Experts on the Transport of Dangerous Goods for consideration.

2.1.3.5.3 Where fireworks of more than one hazard division are packed in the same package they shall be classified on the basis of the highest hazard division unless test data derived from Test Series 6 of the *Manual of Tests and Criteria* indicate otherwise.

2.1.3.5.4 The classification shown in the table in 2.1.3.5.5 applies only for articles packed in fibreboard boxes (4G).

### 2.1.3.5.5 Default fireworks classification table\*

**Note 1:** References to percentages in the table, unless otherwise stated, are to the mass of all pyrotechnic substances (e.g. rocket motors, lifting charge, bursting charge and effect charge).

**Note 2:** "Flash composition" in this table refers to pyrotechnic substances in powder form or as pyrotechnic units as presented in the fireworks that are used in waterfalls, or to produce an aural effect or used as a bursting charge, or propellant charge unless:

- (a) the time taken for the pressure rise in the HSL Flash Composition Test in appendix 7 of the *Manual of Tests and Criteria* is demonstrated to be more than 6 ms for 0.5 g of pyrotechnic substance; or
- (b) the pyrotechnic substance gives a negative "–" result in the US Flash Composition Test in Appendix 7 of the *Manual of Tests and Criteria*.

**Note 3:** Dimensions in millimetres refers to:

- for spherical and peanut shells, the diameter of the sphere of the shell;
- for cylinder shells, the length of the shell;
- for a shell in mortar, Roman candle, shot tube firework or mine, the inside diameter of the tube comprising or containing the firework;
- for a bag mine or cylinder mine, the inside diameter of the mortar intended to contain the mine.

\*This table contains a list of firework classifications that may be used in the absence of Test Series 6, of the *Manual of Tests and Criteria*, data (see 2.1.3.5.2).

| Type                            | Includes: / Synonym:  | Definition   | Specification  | Classification |
|---------------------------------|---|--|--|----------------|
| Shell, spherical or cylindrical | Spherical display shell: aerial shell, colour shell, dye shell, multi-break shell, multi-effect shell, nautical shell, parachute shell, smoke shell, star shell; report shell: maroon, salute, sound shell, thunderclap, aerial shell kit | Device with or without propellant charge, with delay fuse and bursting charge, pyrotechnic unit(s) or loose pyrotechnic substance and designed to be projected from a mortar | All report shells  | 1.1G           |
|                                 |   |  | Colour shell: $\geq 180$ mm  | 1.1G           |
|                                 |   |  | Colour shell: $< 180$ mm with $> 25\%$ flash composition, as loose powder and/or report effects  | 1.1G           |
|                                 |   |  | Colour shell: $< 180$ mm with $\leq 25\%$ flash composition, as loose powder and/or report effects   | 1.3G           |
|                                 | Peanut shell  | Device with two or more spherical aerial shells in a common wrapper propelled by the same propellant charge with separate external delay fuses                               | Colour shell: $\leq 50$ mm, or $\leq 60$ g pyrotechnic substance, with $\leq 2\%$ flash composition as loose powder and/or report effects  | 1.4G           |
|                                 |   |  | The most hazardous spherical aerial shell determines the classification  |                |
|                                 | Preloaded mortar, shell in mortar   | Assembly comprising a spherical or cylindrical shell inside a mortar from which the shell is designed to be projected  | All report shells  |                |
|                                 |   |  | Colour shell: $\geq 180$ mm  | 1.1G           |
|                                 |   |  | Colour shell: $> 25\%$ flash composition as loose powder and/or report effects   | 1.1G           |
|                                 |   |  | Colour shell: $> 50$ mm and $< 180$ mm   | 1.2G           |
|                                 |   |  | Colour shell: $\leq 50$ mm, or $\leq 60$ g pyrotechnic substance, with $\leq 25\%$ flash composition as loose powder and/or report effects | 1.3G           |



Part 2 – Classification

2

| Type                    | Includes: / Synonym:  | Definition  | Specification  | Classification       |
|-------------------------|---|---|--|----------------------|
|                         | Shell of shells (spherical)<br>(Reference to percentages for shell of shells are to the gross mass of the fireworks article)    | Device without propellant charge, with delay fuse and bursting charge, containing report shells and inert materials and designed to be projected from a mortar  | > 120 mm   | 1.1G                 |
|                         |   | Device without propellant charge, with delay fuse and bursting charge, containing report shells ≤ 25 g flash composition per report unit, with ≤ 33% flash composition and ≥ 60% inert materials and designed to be projected from a mortar | ≤ 120 mm   | 1.3G                 |
|                         |   | Device without propellant charge, with delay fuse and bursting charge, containing colour shells and/or pyrotechnic units and designed to be projected from a mortar   | > 300 mm   | 1.1G                 |
|                         |   | Device without propellant charge, with delay fuse and bursting charge, containing colour shells ≤ 70 mm and/or pyrotechnic units, with ≤ 25% flash composition and ≤ 60% pyrotechnic substance and designed to be projected from a mortar   | > 200 mm and ≤ 300 mm  | 1.3G                 |
|                         |   | Device with propellant charge, with delay fuse and bursting charge, containing colour shells ≤ 70 mm and/or pyrotechnic units, with ≤ 25% flash composition and ≤ 60% pyrotechnic substance and designed to be projected from a mortar      | ≤ 200 mm   | 1.3G                 |
| Battery/<br>combination | Barrage, bombardos, cakes, finale box, flowerbed, hybrid, multiple tubes, shell cakes, banger batteries, flash banger batteries | Assembly including several elements either containing the same type or several types each corresponding to one of the types of fireworks listed in this table, with one or two points of ignition   | The most hazardous fireworks type determines the classification  |                      |
| Roman candle            | Exhibition candle, candle, bombettes  | Tube containing a series of pyrotechnic units consisting of alternate pyrotechnic substance, propellant charge, and transmitting fuse   | ≥ 50 mm inner diameter, containing flash composition, or < 50 mm with > 25% flash composition<br>≥ 50 mm inner diameter, containing no flash composition<br>< 50 mm inner diameter and ≤ 25% flash composition | 1.1G<br>1.2G<br>1.3G |
|                         |   |   | ≤ 30 mm inner diameter, each pyrotechnic unit ≤ 25 g and ≤ 5% flash composition  | 1.4G                 |
| Shot tube               | Single shot Roman candle, small preloaded mortar  | Tube containing a pyrotechnic unit consisting of pyrotechnic substance, propellant charge with or without transmitting fuse   | ≤ 30 mm inner diameter and pyrotechnic unit > 25 g, or > 5% and ≤ 25% flash composition<br>≤ 30 mm inner diameter, pyrotechnic unit ≤ 25 g and ≤ 5% flash composition  | 1.3G<br>1.4G         |

| Type         | Includes: / Synonym:   | Definition  | Specification   | Classification               |
|--------------|--|---|---|------------------------------|
| Rocket       | Avalanche rocket, signal rocket, whistling rocket, bottle rocket, sky rocket, missile type rocket, table rocket  | Tube containing pyrotechnic substance and/or pyrotechnic units, equipped with stick(s) or other means for stabilization of flight, and designed to be propelled into the air  | Flash composition effects only<br>Flash composition > 25% of the pyrotechnic substance<br>> 20 g pyrotechnic substance and flash composition ≤ 25 %<br>≤ 20 g pyrotechnic substance, black powder bursting charge and ≤ 0.13 g flash composition per report and ≤ 1 g in total  | 1.1G<br>1.1G<br>1.3G<br>1.4G |
| Mine         | Pot-a-feu, ground mine, bag mine, cylinder mine  | Tube containing propellant charge and pyrotechnic units and designed to be placed on the ground or to be fixed in the ground. The principal effect is ejection of all the pyrotechnic units in a single burst producing a widely dispersed visual and/or aural effect in the air or:<br>Cloth or paper bag or cloth or paper cylinder containing propellant charge and pyrotechnic units, designed to be placed in a mortar and to function as a mine | > 25% flash composition, as loose powder and/or report effects<br>≥ 180 mm and ≤ 25% flash composition, as loose powder and/or report effects<br>< 180 mm and ≤ 25% flash composition, as loose powder and/or report effects<br>≤ 150 g pyrotechnic substance, containing ≤ 5% flash composition as loose powder and/or report effects. Each pyrotechnic unit ≤ 25 g, each report effect < 2 g; each whistle, if any, ≤ 3 g<br>≥ 1 kg pyrotechnic substance<br>< 1 kg pyrotechnic substance | 1.1G<br>1.1G<br>1.3G<br>1.4G |
| Fountain     | Volcanos, gerbs, lances, Bengal fire, flitter sparkle, cylindrical fountains, cone fountains, illuminating torch | Non-metallic case containing pressed or consolidated pyrotechnic substance producing sparks and flame<br><b>Note:</b> Fountains intended to produce a vertical cascade or curtain of sparks are considered to be waterfalls (see row below).  | ≥ 1 kg pyrotechnic substance<br>< 1 kg pyrotechnic substance  | 1.3G<br>1.4G                 |
| Waterfall    | Cascades, showers  | Pyrotechnic fountain intended to produce a vertical cascade or curtain of sparks  | Containing flash composition regardless of the results of Test Series 6 (see 2.1.3.5.1.1)   | 1.1G                         |
| Sparkler     | Handheld sparklers, non-handheld sparklers, wire sparklers   | Rigid wire partially coated (along one end) with slow-burning pyrotechnic substance with or without an ignition tip   | Not containing flash composition<br>Perchlorate based sparklers: > 5 g per item or > 10 items per pack<br>Perchlorate based sparklers: ≤ 5 g per item and ≤ 10 items per pack<br>Nitrate based sparklers: ≤ 30 g per item   | 1.3G<br>1.3G<br>1.4G         |
| Bengal stick | Dipped stick   | Non-metallic stick partially coated (along one end) with slow-burning pyrotechnic substance and designed to be held in the hand   | Perchlorate based items: > 5 g per item or > 10 items per pack<br>Perchlorate based items: ≤ 5 g per item and ≤ 10 items per pack; nitrate based items: ≤ 30 g per item   | 1.3G<br>1.4G                 |

Part 2 – Classification

2

| Type                               | Includes: / Synonym:  | Definition   | Specification  | Classification       |
|------------------------------------|---|--|--|----------------------|
| Low hazard fireworks and novelties | Table bombs, throwdowns, crackling granules, smokes, fog, snakes, glow worm, serpents, snaps, party poppers | Device designed to produce very limited visible and/or audible effect which contains small amounts of pyrotechnic and/or explosive substance                       | Throwdowns and snaps may contain up to 1.6 mg of silver fulminate; snaps and party poppers may contain up to 16 mg of potassium chlorate/red phosphorus mixture; other articles may contain up to 5 g of pyrotechnic substance, but no flash composition   | 1.4G                 |
| Spinner                            | Aerial spinner, helicopter, chaser, ground spinner  | Non-metallic tube or tubes containing gas- or spark-producing pyrotechnic substance, with or without noise-producing substance, with or without aerofoils attached | Pyrotechnic substance per item > 20 g, containing ≤ 3% flash composition as report effects, or whistle composition ≤ 5 g<br><br>Pyrotechnic substance per item ≤ 20 g, containing ≤ 3% flash composition as report effects, or whistle composition ≤ 5 g   | 1.3G<br><br>1.4G     |
| Wheels                             | Catherine wheels, Saxon   | Assembly including drivers containing pyrotechnic substance and provided with a means of attaching it to a support so that it can rotate                           | ≥ 1 kg total pyrotechnic substance, no report effect, each whistle (if any) ≤ 25 g and ≤ 50 g whistle composition per wheel<br><br>< 1 kg total pyrotechnic substance, no report effect, each whistle (if any) ≤ 5 g and ≤ 10 g whistle composition per wheel  | 1.3G<br><br>1.4G     |
| Aerial wheel                       | Flying Saxon, UFOs, rising crown  | Tubes containing propellant charges and sparks-, flame- and/or noise-producing pyrotechnic substances, the tubes being fixed to a supporting ring                  | > 200 g total pyrotechnic substance or > 60 g pyrotechnic substance per driver, ≤ 3% flash composition as report effects, each whistle (if any) ≤ 25 g and ≤ 50 g whistle composition per wheel<br><br>≤ 200 g total pyrotechnic substance and ≤ 60 g pyrotechnic substance per driver, ≤ 3% flash composition as report effects, each whistle (if any) ≤ 5 g and ≤ 10 g whistle composition per wheel | 1.3G<br><br>1.4G     |
| Selection pack                     | Display selection box, display selection pack, garden selection box, indoor selection box; assortment       | A pack of more than one type each corresponding to one of the types of fireworks listed in this table  | The most hazardous firework type determines the classification   |                      |
| Firecracker                        | Celebration cracker, celebration roll, string cracker   | Assembly of tubes (paper or cardboard) linked by a pyrotechnic fuse, each tube intended to produce an aural effect   | Each tube ≤ 140 mg of flash composition or ≤ 1 g black powder  | 1.4G                 |
| Banger                             | Salute, flash banger, lady cracker  | Non-metallic tube containing report composition intended to produce an aural effect  | > 2 g flash composition per item<br>≤ 2 g flash composition per item and ≤ 10 g per inner packaging<br>≤ 1 g flash composition per item and ≤ 10 g per inner packaging or ≤ 10 g black powder per item   | 1.1G<br>1.3G<br>1.4G |



**2.1.3.6 Classification documentation**

- 2.1.3.6.1 A competent authority assigning an article or substance into class 1 should confirm with the applicant that classification in writing.
- 2.1.3.6.2 A competent authority classification document may be in any form and may consist of more than one page, provided pages are numbered consecutively. The document should have a unique reference.
- 2.1.3.6.3 The information provided shall be easy to identify, legible and durable.
- 2.1.3.6.4 Examples of the information that may be provided in the classification documents are as follows:
- .1 the name of the competent authority and the provisions in national legislation under which it is granted its authority;
  - .2 the modal or national regulations for which the classification document is applicable;
  - .3 confirmation that the classification has been approved, made or agreed in accordance with the United Nations Recommendations on the Transport of Dangerous Goods or the relevant modal regulations;
  - .4 the name and address of the person in law to which the classification has been assigned and any company registration which uniquely identifies a company or other body corporate under national legislation;
  - .5 the name under which the explosives will be placed on the market or otherwise supplied for transport;
  - .6 the Proper Shipping Name, UN number, Class, Hazard Division and corresponding compatibility group of the explosives;
  - .7 where appropriate, the maximum net explosive mass of the package or article;
  - .8 the name, signature, stamp, seal or other identification of the person authorized by the competent authority to issue the classification document is clearly visible;
  - .9 where safety in transport or the hazard division is assessed as being dependent upon the packaging, the packaging mark or a description of the permitted:
    - inner packagings
    - intermediate packagings
    - outer packagings
  - .10 the classification document states the part number, stock number or other identifying reference under which the explosives will be placed onto the market or otherwise supplied for transport;
  - .11 the name and address of the person in law who manufactured the explosives and any company registration which uniquely identifies a company or other body corporate under national legislation;
  - .12 any additional information regarding the applicable packing instruction and special packing provisions where appropriate;
  - .13 the basis for assigning the classification, i.e. whether on the basis of test results, default for fireworks, analogy with classified explosive, by definition from the Dangerous Goods List etc.;
  - .14 any special conditions or limitations that the competent authority has identified as relevant to the safety for transport of the explosives, the communication of the hazard and international transport; and
  - .15 the expiry date of the classification document is given where the competent authority considers one to be appropriate.



## Chapter 2.2

### Class 2 – Gases

#### 2.2.0 Introductory note

“Toxic” has the same meaning as “poisonous”.

#### 2.2.1 Definitions and general provisions

2.2.1.1 A gas is a substance which:

- .1 at 50°C has a vapour pressure greater than 300 kPa; or
- .2 is completely gaseous at 20°C at a standard pressure of 101.3 kPa.

2.2.1.2 The transport condition of a gas is described according to its physical state as:

- .1 *compressed gas*: a gas which when packaged under pressure for transport is entirely gaseous at –50°C; this category includes all gases with a critical temperature less than or equal to –50°C;
- .2 *liquefied gas*: a gas which when packaged under pressure for transport is partially liquid at temperatures above –50 °C. A distinction is made between:
  - high pressure liquefied gas*: a gas with a critical temperature between –50°C and +65°C, and
  - low pressure liquefied gas*: a gas with a critical temperature above +65°C;
- .3 *refrigerated liquefied gas*: a gas which when packaged for transport is made partially liquid because of its low temperature;
- .4 *dissolved gas*: a gas which when packaged under pressure for transport is dissolved in a liquid phase solvent;
- .5 *adsorbed gas*: a gas which when packaged for transport is adsorbed onto a solid porous material resulting in an internal receptacle pressure of less than 101.3 kPa at 20°C and less than 300 kPa at 50°C.

2.2.1.3 The class comprises compressed gases, liquefied gases, dissolved gases, refrigerated liquefied gases, adsorbed gases, mixtures of one or more gases with one or more vapours of substances of other classes, articles charged with a gas, aerosols and chemicals under pressure.

2.2.1.4 Gases are normally transported under pressure varying from high pressure in the case of compressed gases to low pressure in the case of refrigerated gases.

2.2.1.5 According to their chemical properties or physiological effects, which may vary widely, gases may be: flammable; non-flammable; non-toxic; toxic; supporters of combustion; corrosive; or may possess two or more of these properties simultaneously.

2.2.1.5.1 Some gases are chemically and physiologically inert. Such gases as well as other gases, normally accepted as non-toxic, will nevertheless be suffocating in high concentrations.

2.2.1.5.2 Many gases of this class have narcotic effects which may occur at comparatively low concentrations or may evolve highly toxic gases when involved in a fire.

2.2.1.5.3 All gases which are heavier than air will present a potential danger if allowed to accumulate in the bottom of cargo spaces.

#### 2.2.2 Class subdivisions

Class 2 is subdivided further according to the primary hazard of the gas during transport:

**Note:** For UN 1950 AEROSOLS, see also the criteria in special provision 63. For chemicals under pressure of UN Nos. 3500 to 3505, see also special provision 362. For UN 2037 RECEPTACLES, SMALL, CONTAINING GAS (GAS CARTRIDGES), see also special provision 303.

### 2.2.2.1 Class 2.1 Flammable gases

Gases which at 20°C and a standard pressure of 101.3 kPa:

- .1 are ignitable when in a mixture of 13% or less by volume with air; or
- .2 have a flammable range with air of at least 12 percentage points regardless of the lower flammable limit. Flammability shall be determined by tests or calculation in accordance with methods adopted by the International Organization for Standardization (see ISO 10156:2017). Where insufficient data are available to use these methods, tests by a comparable method recognized by a national competent authority may be used.

### 2.2.2.2 Class 2.2 Non-flammable, non-toxic gases

Gases which:

- .1 are asphyxiant – gases which dilute or replace the oxygen normally in the atmosphere; or
- .2 are oxidizing – gases which may, generally by providing oxygen, cause or contribute to the combustion of other material more than air does; or
- .3 do not come under the other classes.

**Note:** In 2.2.2.2, “gases which cause or contribute to the combustion of other material more than air does” means pure gases or gas mixtures with an oxidizing power greater than 23.5% as determined by a method specified in ISO 10156:2017.

### 2.2.2.3 Class 2.3 Toxic gases

Gases which:

- .1 are known to be so toxic or corrosive to humans as to pose a hazard to health; or
- .2 are presumed to be toxic or corrosive to humans because they have a LC<sub>50</sub> value (as defined in 2.6.2.1) equal to or less than 5,000 mL/m<sup>3</sup> (ppm).

**Note:** Gases meeting the above criteria owing to their corrosivity are to be classified as toxic with a subsidiary corrosive hazard.

2.2.2.4 Gases and gas mixtures with hazards associated with more than one division take the following precedence:

- .1 class 2.3 takes precedence over all other classes;
- .2 class 2.1 takes precedence over class 2.2.

2.2.2.5 Gases of class 2.2 are not subject to the provisions of this Code if they are transported at a pressure of less than 200 kPa at 20°C and are not liquefied or refrigerated liquefied gases.

2.2.2.6 Gases of class 2.2 are not subject to the provisions of this Code when contained in the following:

- .1 foodstuffs (except UN 1950), including carbonated beverages;
- .2 balls intended for use in sports; or
- .3 tyres (except for air transport).

**Note:** This exemption does not apply to lamps. For lamps see 1.1.1.9.

## 2.2.3 Mixtures of gases

For the classification of gas mixtures (including vapours of substances from other classes), the following principles shall be used:

- .1 Flammability shall be determined by tests or calculation in accordance with methods adopted by the International Organization for Standardization (see ISO 10156:2017). Where insufficient data are available to use these methods, tests by a comparable method recognized by a national competent authority may be used.
- .2 The level of toxicity is determined either by tests to measure the LC<sub>50</sub> value (as defined in 2.6.2.1) or by a calculation method using the following formula:

$$LC_{50} \text{ Toxic (mixture)} = \frac{1}{\sum_{i=1}^n \frac{f_i}{T_i}}$$

where:  $f_i$  = mole fraction of the  $i^{\text{th}}$  component substance of the mixture;

$T_i$  = toxicity index of the  $i^{\text{th}}$  component substance of the mixture (the  $T_i$  equals the LC<sub>50</sub> value when available).

**Part 2 – Classification**

When LC<sub>50</sub> values are unknown, the toxicity index is determined by using the lowest LC<sub>50</sub> value of substances of similar physiological and chemical effects, or through testing if this is the only practical possibility.

- .3 A gas mixture has a subsidiary hazard of corrosivity when the mixture is known by human experience to be destructive to the skin, eyes or mucous membranes or when the LC<sub>50</sub> value of the corrosive components of the mixture is equal to or less than 5,000 mL/m<sup>3</sup> (ppm) when the LC<sub>50</sub> is calculated by the formula:

$$LC_{50} \text{ Corrosive (mixture)} = \frac{1}{\sum_{i=1}^n \frac{f_{ci}}{T_{ci}}}$$

where:  $f_{ci}$  = mole fraction of the  $i^{\text{th}}$  corrosive component substance of the mixture;

$T_{ci}$  = toxicity index of the  $i^{\text{th}}$  corrosive component substance of the mixture (the  $T_{ci}$  equals the LC<sub>50</sub> value when available).

- .4 Oxidizing ability is determined either by tests or by calculation methods adopted by the International Organization for Standardization (see note in 2.2.2.2).

### 2.2.4 Gases not accepted for transport

Chemically unstable gases of class 2 shall not be accepted for transport unless the necessary precautions have been taken to prevent the possibility of a dangerous decomposition or polymerization under normal conditions of transport or unless transported in accordance with special packing provision (r) of packing instruction P200 (5) of 4.1.4.1, as applicable. For the precautions necessary to prevent polymerization, see special provision 386 of chapter 3.3. To this end particular care shall be taken to ensure that receptacles and tanks do not contain any substances liable to promote these reactions.

## Chapter 2.3

### Class 3 – Flammable liquids

#### 2.3.0 Introductory note

The flashpoint of a flammable liquid may be altered by the presence of an impurity. The substances listed in class 3 in the Dangerous Goods List in chapter 3.2 shall generally be regarded as chemically pure. Since commercial products may contain added substances or impurities, flashpoints may vary, and this may have an effect on classification or determination of the packing group for the product. In the event of doubt regarding the classification or packing group of a substance, the flashpoint of the substance shall be determined experimentally.

#### 2.3.1 Definitions and general provisions

2.3.1.1 Class 3 includes the following substances:

- .1 flammable liquids (see 2.3.1.2 and 2.3.1.3);
- .2 liquid desensitized explosives (see 2.3.1.4).

2.3.1.2 *Flammable liquids* are liquids, or mixtures of liquids, or liquids containing solids in solution or suspension (such as paints, varnishes, lacquers, etc., but not including substances which, on account of their other dangerous characteristics, have been included in other classes) which give off a flammable vapour at or below 60°C closed-cup test (corresponding to 65.6°C open-cup test), normally referred to as the “flashpoint”. This also includes:

- .1 liquids offered for transport at temperatures at or above their flashpoint; and
- .2 substances transported or offered for transport at elevated temperatures in a liquid state, which give off a flammable vapour at temperatures equal to or below the maximum transport temperature.

2.3.1.3 However, the provisions of this Code need not apply to such liquids with a flashpoint of more than 35°C which do not sustain combustion. Liquids are considered to be unable to sustain combustion for the purposes of the Code if:

- .1 they have passed the suitable combustibility test (see the Sustained Combustibility Test prescribed in part III, 32.5.2 of the *Manual of Tests and Criteria*); or
- .2 their fire point according to ISO 2592:1973 is greater than 100°C; or
- .3 they are water-miscible solutions with a water content of more than 90%, by mass.

△ 2.3.1.4 *Liquid desensitized explosives* are explosive substances which are dissolved or suspended in water or other liquid substances, to form a homogeneous liquid mixture to suppress their explosive properties. Entries in the Dangerous Goods List for liquid desensitized explosives are UN 1204, UN 2059, UN 3064, UN 3343, UN 3357, UN 3379 and UN 3555.

#### 2.3.2 Assignment of packing group

2.3.2.1 The criteria in 2.3.2.6 are used to determine the hazard grouping of a liquid that presents a hazard due to flammability.

2.3.2.1.1 For liquids whose only hazard is flammability, the packing group for the substance is the hazard grouping shown in 2.3.2.6.

2.3.2.1.2 For a liquid with additional hazard(s), the hazard group determined from 2.3.2.6 and the hazard group based on the severity of the additional hazard(s) shall be considered, and the classification and packing group determined in accordance with the provisions in chapter 2.0.

Part 2 – Classification

2.3.2.2 Viscous flammable liquids such as paints, enamels, lacquers, varnishes, adhesives and polishes having a flashpoint of less than 23°C may be placed in packing group III in conformity with the procedures prescribed in the *Manual of Tests and Criteria*, part III, subsection 32.3, provided that:

.1 The viscosity\* and flashpoint are in accordance with the following table:

| Kinematic viscosity (extrapolated) $\nu$ (at near-zero shear rate) mm <sup>2</sup> /s at 23°C | Flow-time $t$ in seconds | Jet diameter (mm) | Flashpoint (closed-cup) in °C |
|---|--------------------------|-------------------|-------------------------------|
| 20 < $\nu$ ≤ 80   | 20 < $t$ ≤ 60            | 4                 | above 17                      |
| 80 < $\nu$ ≤ 135  | 60 < $t$ ≤ 100           | 4                 | above 10                      |
| 135 < $\nu$ ≤ 220   | 20 < $t$ ≤ 32            | 6                 | above 5                       |
| 220 < $\nu$ ≤ 300   | 32 < $t$ ≤ 44            | 6                 | above –1                      |
| 300 < $\nu$ ≤ 700   | 44 < $t$ ≤ 100           | 6                 | above –5                      |
| 700 < $\nu$   | 100 < $t$                | 6                 | no limit                      |

.2 less than 3% of the clear solvent layer separates in the solvent separation test;

.3 the mixture or any separated solvent does not meet the criteria for class 6.1 or class 8;

.4 the substances are packed in receptacles of not more than 450 L capacity.

2.3.2.3 [Reserved]

2.3.2.4 Substances classified as flammable liquids due to their being transported or offered for transport at elevated temperatures are included in packing group III.

2.3.2.5 Viscous liquids which:

- have a flashpoint of 23°C or above and less than or equal to 60°C;
- are not toxic or corrosive;
- are not environmentally hazardous or are environmentally hazardous transported in single or combination packagings containing a net quantity per single or inner packaging of 5 L or less, provided the packagings meet the general provisions of 4.1.1.1, 4.1.1.2 and 4.1.1.4 to 4.1.1.8;
- contain not more than 20% nitrocellulose provided the nitrocellulose contains not more than 12.6% nitrogen by dry mass; and
- are packed in receptacles of not more than 450 L capacity,

are not subject to the provisions for the marking, labelling and testing of packages in chapters 4.1, 5.2 and 6.1, if:

.1 in the solvent separation test (see part III, 32.5.1 of the *Manual of Tests and Criteria*) the height of the separated layer of solvent is less than 3% of the total height; and

.2 the flowtime in the viscosity test (see part III, 32.4.3 of the *Manual of Tests and Criteria*) with a jet diameter of 6 mm is equal to or greater than:

.1 60 s; or

.2 40 s if the viscous liquid contains not more than 60% of class 3 substances.

The following statement shall be included in the transport document: “Transport in accordance with 2.3.2.5 of the IMDG Code” (see 5.4.1.5.10).

2.3.2.6 Hazard grouping based on flammability

Flammable liquids are grouped for packing purposes according to their flashpoint, their boiling point, and their viscosity. This table shows the relationship between two of these characteristics.

| Packing group | Flashpoint (closed-cup) in °C | Initial boiling point in °C |
|---------------|-------------------------------|-----------------------------|
| I             | –                             | ≤ 35                        |
| II            | < 23                          | > 35                        |
| III           | ≥ 23 to ≤ 60                  | > 35                        |

\* *Viscosity determination*: Where the substance concerned is non-Newtonian, or where a flow cup method of viscosity determination is otherwise unsuitable, a variable shear-rate viscometer shall be used to determine the dynamic viscosity coefficient of the substance, at 23°C, at a number of shear rates. The values obtained are plotted against shear rate and then extrapolated to zero shear rate. The dynamic viscosity thus obtained, divided by the density, gives the apparent kinematic viscosity at near-zero shear rate.

### 2.3.3 Determination of flashpoint

**Note:** The provisions of this section are not mandatory.

2.3.3.1 The flashpoint of a flammable liquid is the lowest temperature of the liquid at which its vapour forms an ignitable mixture with air. It gives a measure of the risk of formation of explosive or ignitable mixtures when the liquid escapes from its packing. A flammable liquid cannot be ignited so long as its temperature remains below the flashpoint.

**Note:** Do not confuse the flashpoint with the ignition temperature, which is the temperature to which an explosive vapour–air mixture must be heated to cause actual explosion. There is no relationship between the flashpoint and the ignition temperature.

2.3.3.2 The flashpoint is not an exact physical constant for a given liquid. It depends to some extent on the construction of the test apparatus used and on the testing procedure. Therefore, when providing flashpoint data, specify the name of the test apparatus.

2.3.3.3 Several standard apparatuses are in current use. They all operate on the same principle: a specified quantity of the liquid is introduced into a receptacle at a temperature well below the flashpoint to be expected, then slowly heated; periodically, a small flame is brought near to the surface of the liquid. The flashpoint is the lowest temperature at which a “flash” is observed.

2.3.3.4 The test methods can be divided into two groups, depending on the use in an apparatus of an open receptacle (open-cup methods) or a closed one which is only opened to admit the flame (closed-cup methods). As a rule, the flashpoints found in an open-cup test are a few degrees higher than in a closed-cup test.

2.3.3.5 In general, reproducibility in closed-cup apparatus is better than in open-cup.

2.3.3.5.1 It is therefore recommended that flashpoints, especially in the range around 23°C, shall be determined by means of closed-cup (c.c) methods.

2.3.3.5.2 Flashpoint data in this Code are generally based on closed-cup methods. In countries where it is customary to determine flashpoints by the open-cup method, the temperatures given by that method would need to be reduced to correspond with those in this Code.

#### 2.3.3.6 Determination of flashpoint

The following methods for determining the flashpoint of flammable liquids may be used:

**International standards:**

ISO 1516  
ISO 1523  
ISO 2719  
ISO 13736  
ISO 3679  
ISO 3680

**National standards:**

American Society for Testing Materials International, 100 Barr Harbor Drive, PO Box C700,  
West Conshohocken, Pennsylvania, USA 19428-2959:

ASTM D3828-07a, Standard Test Methods for Flash Point by Small Scale Closed Cup Tester  
ASTM D56-05, Standard Test Method for Flash Point by Tag Closed Cup Tester  
ASTM D3278-96(2004)e, Standard Test Methods for Flash Point of Liquids by Small Scale Closed-Cup  
Apparatus  
ASTM D93-08, Standard Test Methods for Flash Point by Pensky-Martens Closed Cup Tester

Association française de normalisation, AFNOR, 11, rue Francis de Pressensé, 93571 La Plaine Saint-Denis  
Cedex:

French Standard NF M 07-019  
French Standards NF M 07-011/NF T 30-050/NF T 66-009  
French Standard NF M 07-036

Deutsches Institut für Normung, Burggrafenstr. 6, D-10787 Berlin:

Standard DIN 51755 (flashpoints below 65°C)

State Committee of the Council of Ministers for Standardization, 113813, GSP, Moscow,  
M-49 Leninsky Prospect, 9:

GOST 12.1.044-84

### 2.3.4 Determination of initial boiling point

The following methods for determining the initial boiling point of flammable liquids may be used:

**International standards:**

ISO 3924  
ISO 4626  
ISO 3405

**National standards:**

American Society for Testing Materials International, 100 Barr Harbor Drive, PO Box C700,  
West Conshohocken, Pennsylvania, USA 19428-2959:

ASTM D86-07a, Standard Test Method for Distillation of Petroleum Products at Atmospheric Pressure  
ASTM D1078-05, Standard Test Method for Distillation Range of Volatile Organic Liquids

**Further acceptable methods:**

Method A.2 as described in Part A of the Annex to Commission Regulation (EC) No. 440/2008.\*

### 2.3.5 Substances not accepted for transport

Chemically unstable substances of class 3 shall not be accepted for transport unless the necessary precautions have been taken to prevent the possibility of a dangerous decomposition or polymerization under normal conditions of transport. For the precautions necessary to prevent polymerization, see special provision 386 of chapter 3.3. To this end particular care shall be taken to ensure that receptacles and tanks do not contain any substances liable to promote these reactions.

\* Commission Regulation (EC) No. 440/2008 of 30 May 2008 laying down test methods pursuant to Regulation (EC) No. 1907/2006 of the European Parliament and of the Council on the *Registration, Evaluation, Authorisation and Restriction of Chemicals* (REACH) (Official Journal of the European Union, No. L 142 of 31.05.2008, pages 1–739 and No. L 143 of 03.06.2008, page 55).

## Chapter 2.4

---

### *Class 4 – Flammable solids; substances liable to spontaneous combustion; substances which, in contact with water, emit flammable gases*

#### 2.4.0 Introductory note

Since organometallic substances can be classified in classes 4.2 or 4.3 with additional subsidiary hazards, depending on their properties, a specific classification flowchart for these substances is given in 2.4.5.

#### 2.4.1 Definition and general provisions

2.4.1.1 In this Code, class 4 deals with substances, other than those classified as explosives, which, under conditions of transport, are readily combustible or may cause or contribute to a fire. Class 4 is subdivided as follows:

##### Class 4.1 – Flammable solids

Solids which, under conditions encountered in transport, are readily combustible or may cause or contribute to fire through friction; self-reactive substances (solids and liquids) and polymerizing substances which are liable to undergo a strongly exothermic reaction; solid desensitized explosives which may explode if not diluted sufficiently;

##### Class 4.2 – Substances liable to spontaneous combustion

Substances (solids and liquids) which are liable to spontaneous heating under normal conditions encountered in transport, or to heating up in contact with air, and being then liable to catch fire;

##### Class 4.3 – Substances which, in contact with water, emit flammable gases

Substances (solids and liquids) which, by interaction with water, are liable to become spontaneously flammable or to give off flammable gases in dangerous quantities.

2.4.1.2 As referenced in this chapter, test methods and criteria, with advice on application of the tests, are given in the *Manual of Tests and Criteria* for the classification of following types of substances of class 4:

- .1 flammable solids (class 4.1);
- .2 self-reactive substances (class 4.1);
- .3 polymerizing substances (class 4.1);
- .4 pyrophoric solids (class 4.2);
- .5 pyrophoric liquids (class 4.2);
- .6 self-heating substances (class 4.2); and
- .7 substances which, in contact with water, emit flammable gases (class 4.3).

Test methods and criteria for self-reactive substances and polymerizing substances are given in part II of the *Manual of Tests and Criteria*, and test methods and criteria for the other types of substances of class 4 are given in the *Manual of Tests and Criteria*, part III, section 33.

#### 2.4.2 Class 4.1 – Flammable solids, self-reactive substances, solid desensitized explosives and polymerizing substances

##### 2.4.2.1 General

Class 4.1 includes the following types of substances:

- .1 flammable solids (see 2.4.2.2);



## Part 2 – Classification

- .2 self-reactive substances (see 2.4.2.3);
- .3 solid desensitized explosives (see 2.4.2.4); and
- .4 polymerizing substances (see 2.4.2.5).

Some substances (such as celluloid) may evolve toxic and flammable gases when heated or if involved in a fire.

## 2.4.2.2 Class 4.1 Flammable solids

### 2.4.2.2.1 Definitions and properties

2.4.2.2.1.1 For the purpose of this Code, *flammable solids* means readily combustible solids and solids which may cause fire through friction.

2.4.2.2.1.2 *Readily combustible solids* means fibres, powdered, granular, or pasty substances which are dangerous if they can be easily ignited by brief contact with an ignition source such as a burning match, and if the flame spreads rapidly. The danger may come not only from the fire but also from toxic combustion products. Metal powders are especially dangerous because of the difficulty of extinguishing a fire, since normal extinguishing agents such as carbon dioxide or water can increase the hazard.

■ 2.4.2.2.1.3 *Metal powders* means powders of metals or metal alloys.

### 2.4.2.2.2 Classification of flammable solids

△ 2.4.2.2.2.1 Powdered, granular or pasty substances shall be classified as readily combustible solids of class 4.1 when the time of burning of one or more of the test runs, performed in accordance with the test method described in the *Manual of Tests and Criteria*, part III, subsection 33.2, is less than 45 s or the rate of burning is more than 2.2 mm/s. Metal powders shall be classified in class 4.1 when they can be ignited and the reaction spreads over the whole length of the sample in 10 min or less.

2.4.2.2.2.2 Solids which may cause fire through friction shall be classified in class 4.1 by analogy with existing entries (such as matches) until definitive criteria are established.

### 2.4.2.2.3 Assignment of packing groups

△ 2.4.2.2.3.1 Packing groups are assigned on the basis of the test methods referred to in 2.4.2.2.2.1. For readily combustible solids (other than metal powders), packing group II shall be assigned if the burning time is less than 45 s and the flame passes the wetted zone. Packing group II shall be assigned to metal powders if the zone of reaction spreads over the whole length of the sample in five minutes or less.

2.4.2.2.3.2 Packing groups are assigned on the basis of the test methods referred to in 2.4.2.2.2.1. For readily combustible solids (other than metal powders), packing group III shall be assigned if the burning time is less than 45 s and the wetted zone stops the flame propagation for at least four minutes. Packing group III shall be assigned to metal powders if the reaction spreads over the whole length of the sample in more than five minutes but not more than 10 min.

2.4.2.2.3.3 For solids which may cause fire through friction, the packing group shall be assigned by analogy with existing entries or in accordance with any appropriate special provision.

2.4.2.2.4 Pyrophoric metal powders, if wetted with sufficient water to suppress their pyrophoric properties, may be classified as class 4.1.

## 2.4.2.3 Class 4.1 Self-reactive substances

### 2.4.2.3.1 Definitions and properties

2.4.2.3.1.1 For the purposes of this Code:

*Self-reactive substances* are thermally unstable substances liable to undergo a strongly exothermic decomposition even without participation of oxygen (air). Substances are not considered to be self-reactive substances of class 4.1, if:

- .1 they are explosives according to the criteria of class 1;
- .2 they are oxidizing substances according to the classification procedure for class 5.1 (see 2.5.2) except that mixtures of oxidizing substances which contain 5.0% or more of combustible organic substances shall be subjected to the classification procedure defined in note 3;
- .3 they are organic peroxides according to the criteria of class 5.2;
- .4 their heat of decomposition is less than 300 J/g; or
- .5 their self-accelerating decomposition temperature (SADT) (see 2.4.2.3.4) is greater than 75°C for a 50 kg package.

**Note 1:** The heat of decomposition may be determined using any internationally recognized method such as differential scanning calorimetry and adiabatic calorimetry.

**Note 2:** Any substance which shows the properties of a self-reactive substance shall be classified as such, even if this substance gives a positive test result according to 2.4.3.2 for inclusion in class 4.2.

**Note 3:** Mixtures of oxidizing substances meeting the criteria of class 5.1 which contain 5.0% or more of combustible organic substances, which do not meet the criteria mentioned in .1, .3, .4 or .5 above, shall be subjected to the self-reactive substance classification procedure.

A mixture showing the properties of a self-reactive substance, types B to F, shall be classified as a self-reactive substance of class 4.1.

A mixture showing the properties of a self-reactive substance, type G, according to the principle of 2.4.2.3.3.2.7 shall be considered for classification as a substance of class 5.1 (see 2.5.2).

**2.4.2.3.1.2** The decomposition of self-reactive substances can be initiated by heat, contact with catalytic impurities (such as acids, heavy-metal compounds, bases), friction or impact. The rate of decomposition increases with temperature and varies with the substance. Decomposition, particularly if no ignition occurs, may result in the evolution of toxic gases or vapours. For certain self-reactive substances, the temperature shall be controlled. Some self-reactive substances may decompose explosively, particularly if confined. This characteristic may be modified by the addition of diluents or by the use of appropriate packagings. Some self-reactive substances burn vigorously. Self-reactive substances are, for example, some compounds of the types listed below:

- .1 aliphatic azo compounds ( $-C-N=N-C-$ );
- .2 organic azides ( $-C-N_3$ );
- .3 diazonium salts ( $-CN_2^+Z^-$ );
- .4 *N*-nitroso compounds ( $-N-N=O$ ); and
- .5 aromatic sulphonylhydrazides ( $-SO_2-NH-NH_2$ ).

This list is not exhaustive and substances with other reactive groups and some mixtures of substances may have similar properties.

#### **2.4.2.3.2** *Classification of self-reactive substances*

**2.4.2.3.2.1** Self-reactive substances are classified into seven types according to the degree of danger they present. The types of self-reactive substance range from type A, which may not be accepted for transport in the packaging in which it is tested, to type G, which is not subject to the provisions for self-reactive substances of class 4.1. The classification of types B to F is directly related to the maximum quantity allowed in one packaging.

**2.4.2.3.2.2** Self-reactive substances permitted for transport in packagings are listed in 2.4.2.3.2.3, those permitted for transport in IBCs are listed in packing instruction IBC520 and those permitted for transport in portable tanks are listed in portable tank instruction T23. For each permitted substance listed, the appropriate generic entry of the Dangerous Goods List (UN 3221 to UN 3240) is assigned, and appropriate subsidiary hazards and remarks providing relevant transport information are given. The generic entries specify:

- .1 self-reactive substance type (B to F);
- .2 physical state (liquid or solid); and
- .3 temperature control, when required (2.4.2.3.4).

#### **2.4.2.3.2.3** *List of currently assigned self-reactive substances in packagings*

△ In the column “Packing Method” codes “OP1” to “OP8” refer to packing methods in packing instruction P520. Self-reactive substances to be transported shall fulfil the classification and the control and emergency temperatures (derived from the SADT) as listed. For substances permitted in IBCs, see packing instruction IBC520, and for those permitted in tanks, see portable tank instruction T23. The formulations not listed in this subsection but listed in packing instruction IBC520 of 4.1.4.2 and in portable tank instruction T23 of 4.2.5.2.6 may also be transported packed in accordance with packing method OP8 of packing instruction P520 of 4.1.4.1, with the same control and emergency temperatures, if applicable.

**Note:** The classification given in this table is based on the technically pure substance (except where a concentration of less than 100% is specified). For other concentrations, the substances may be classified differently following the procedures in 2.4.2.3.3 and 2.4.2.3.4.

Part 2 – Classification

| UN generic entry                       | Self-reactive substance  | Concentration (%) | Packing method | Control temperature (°C) | Emergency temperature (°C) | Remarks |
|--|--|-------------------|----------------|--------------------------|----------------------------|---------|
| 3222                                   | 2-DIAZO-1-NAPHTHOL-4-SULPHONYL CHLORIDE                                    | 100               | OP5            |                          |                            | (2)     |
|  | 2-DIAZO-1-NAPHTHOL-5-SULPHONYL CHLORIDE                                    | 100               | OP5            |                          |                            | (2)     |
| 3223                                   | SELF-REACTIVE LIQUID, SAMPLE   |                   | OP2            |                          |                            | (8)     |
| 3224                                   | AZODICARBONAMIDE FORMULATION TYPE C  | < 100             | OP6            |                          |                            | (3)     |
|  | 2,2'-AZODI(ISOBTYRONITRILE) as a water-based paste                         | ≤ 50              | OP6            |                          |                            |         |
|  | N,N'-DINITROSO-N,N'-DIMETHYL-TEREPHTHALAMIDE, as a paste                   | 72                | OP6            |                          |                            |         |
|  | N,N'-DINITROSOPENTAMETHYLENETETRAMINE                                      | 82                | OP6            |                          |                            | (7)     |
|  | SELF-REACTIVE SOLID, SAMPLE  |                   | OP2            |                          |                            | (8)     |
| 3226                                   | AZODICARBONAMIDE FORMULATION TYPE D  | < 100             | OP7            |                          |                            | (5)     |
|  | 1,1'-AZODI(HEXAHYDROBENZONITRILE)  | 100               | OP7            |                          |                            |         |
|  | BENZENE-1,3-DISULPHONYL HYDRAZIDE as a paste                               | 52                | OP7            |                          |                            |         |
|  | BENZENESULPHONYL HYDRAZIDE   | 100               | OP7            |                          |                            |         |
|  | 4-(BENZYL(ETHYL)AMINO)-3-ETHOXY-BENZENEDIAZONIUM ZINC CHLORIDE             | 100               | OP7            |                          |                            |         |
|  | 3-CHLORO-4-DIETHYLAMINO BENZENE-DIAZONIUM ZINC CHLORIDE                    | 100               | OP7            |                          |                            |         |
|  | 2-DIAZO-1-NAPHTHOLSULPHONIC ACID ESTER MIXTURE TYPE D                      | < 100             | OP7            |                          |                            | (9)     |
|  | 2,5-DIETHOXY-4-(4-MORPHOLINYL)-BENZENEDIAZONIUM SULPHATE                   | 100               | OP7            |                          |                            |         |
|  | DIPHENYLOXIDE-4,4'-DISULPHONYL HYDRAZIDE                                   | 100               | OP7            |                          |                            |         |
|  | 4-DIPROPYLAMINO BENZENEDIAZONIUM ZINC CHLORIDE                             | 100               | OP7            |                          |                            |         |
|  | 4-METHYLBENZENESULPHONYLHYDRAZIDE  | 100               | OP7            |                          |                            |         |
|  | SODIUM 2-DIAZO-1-NAPHTHOL-4-SULPHONATE                                     | 100               | OP7            |                          |                            |         |
| SODIUM 2-DIAZO-1-NAPHTHOL-5-SULPHONATE | 100  | OP7               |                |                          |                            |         |
| 3227                                   | PHOSPHOROTHIOIC ACID, O-[(CYANOPHENYL METHYLENE) AZANYL] O,O-DIETHYL ESTER | 82-91 (Z isomer)  | OP8            |                          |                            | (10)    |
| 3228                                   | ACETONE-PYROGALLOL COPOLYMER   | 100               | OP8            |                          |                            |         |
|  | 2-DIAZO-1-NAPHTHOL-5-SULPHONATE  |                   |                |                          |                            |         |
|  | 4-(DIMETHYLAMINO)BENZENEDIAZONIUM TRICHLOROZINCATE(-1)                     | 100               | OP8            |                          |                            |         |
| 3229                                   | 2,5-DIBUTOXY-4-(4-MORPHOLINYL)-BENZENEDIAZONIUM TETRACHLOROZINCATE(2:1)    | 100               | OP8            |                          |                            |         |
|  |  |                   |                |                          |                            |         |
| 3230                                   | (7-METHOXY-5-METHYL-BENZOTHIOPHEN-2-YL) BORONIC ACID                       | 88-100            | OP7            |                          |                            | (11)    |
| 3232                                   | AZODICARBONAMIDE FORMULATION TYPE B, TEMPERATURE CONTROLLED                | < 100             | OP5            |                          |                            | (1) (2) |
| 3233                                   | SELF-REACTIVE LIQUID, SAMPLE, TEMPERATURE CONTROLLED                       |                   | OP2            |                          |                            | (8)     |
| 3234                                   | AZODICARBONAMIDE FORMULATION TYPE C, TEMPERATURE CONTROLLED                | < 100             | OP6            |                          |                            | (4)     |
|  | 2,2'-AZODI(ISOBTYRONITRILE)  | 100               | OP6            | +40                      | +45                        |         |
|  | 3-METHYL-4-(PYRROLIDIN-1-YL)BENZENE-DIAZONIUM TETRAFLUOROBORATE            | 95                | OP6            | +45                      | +50                        |         |
|  | SELF-REACTIVE SOLID, SAMPLE, TEMPERATURE CONTROLLED                        |                   | OP2            |                          |                            | (8)     |
|  | TETRAMINEPALLADIUM(II) NITRATE   | 100               | OP6            | +30                      | +35                        |         |
| 3235                                   | 2,2'-AZODI(ETHYL-2-METHYLPROPIONATE)                                       | 100               | OP7            | +20                      | +25                        |         |

| UN generic entry  | Self-reactive substance   | Concentration (%) | Packing method | Control temperature (°C) | Emergency temperature (°C) | Remarks |
|---|---|-------------------|----------------|--------------------------|----------------------------|---------|
| 3236  | AZODICARBONAMIDE FORMULATION TYPE D, TEMPERATURE CONTROLLED   | < 100             | OP7            |                          |                            | (6)     |
|   | 2,2'-AZODI(2,4-DIMETHYL-4-METHOXY-VALERONITRILE)  | 100               | OP7            | -5                       | +5                         |         |
|   | 2,2'-AZODI(2,4-DIMETHYLVALERONITRILE)   | 100               | OP7            | +10                      | +15                        |         |
|   | 2,2'-AZODI(2-METHYLBUTYRONITRILE)   | 100               | OP7            | +35                      | +40                        |         |
|   | 4-(BENZYL(METHYL)AMINO)-3-ETHOXY-BENZENEDIAZONIUM ZINC CHLORIDE   | 100               | OP7            | +40                      | +45                        |         |
|   | 2,5-DIETHOXY-4-MORPHOLINO-BENZENEDIAZONIUM ZINC CHLORIDE  | 67-100            | OP7            | +35                      | +40                        |         |
|   | 2,5-DIETHOXY-4-MORPHOLINO-BENZENEDIAZONIUM ZINC CHLORIDE  | 66                | OP7            | +40                      | +45                        |         |
|   | 2,5-DIETHOXY-4-MORPHOLINOBENZENE-DIAZONIUM TETRAFLUOROBORATE  | 100               | OP7            | +30                      | +35                        |         |
|   | 2,5-DIETHOXY-4-(PHENYLSULPHONYL)-BENZENEDIAZONIUM ZINC CHLORIDE   | 67                | OP7            | +40                      | +45                        |         |
|   | 2,5-DIMETHOXY-4-(4-METHYLPHENYL-SULPHONYL)BENZENEDIAZONIUM ZINC CHLORIDE                                  | 79                | OP7            | +40                      | +45                        |         |
|   | 4-DIMETHYLAMINO-6-(2-DIMETHYLAMINO-ETHOXY)TOLUENE-2-DIAZONIUM ZINC CHLORIDE                               | 100               | OP7            | +40                      | +45                        |         |
|   | 2-(N,N-ETHOXYCARBONYLPHENYLAMINO)-3-METHOXY-4-(N-METHYL-N-CYCLOHEXYLAMINO)-BENZENEDIAZONIUM ZINC CHLORIDE | 63-92             | OP7            | +40                      | +45                        |         |
|   | 2-(N,N-ETHOXYCARBONYLPHENYLAMINO)-3-METHOXY-4-(N-METHYL-N-CYCLOHEXYLAMINO)-BENZENEDIAZONIUM ZINC CHLORIDE | 62                | OP7            | +35                      | +40                        |         |
|   | N-FORMYL-2-(NITROMETHYLENE)-1,3-PERHYDROTHIAZINE  | 100               | OP7            | +45                      | +50                        |         |
|   | 2-(2-HYDROXYETHOXY)-1-(PYRROLIDIN-1-YL)-BENZENE-4-DIAZONIUM ZINC CHLORIDE                                 | 100               | OP7            | +45                      | +50                        |         |
|   | 3-(2-HYDROXYETHOXY)-4-(PYRROLIDIN-1-YL)-BENZENEDIAZONIUM ZINC CHLORIDE                                    | 100               | OP7            | +40                      | +45                        |         |
| 2-(N,N-METHYLAMINOETHYLCARBONYL)-4-(3,4-DIMETHYLPHENYLSULPHONYL)-BENZENEDIAZONIUM HYDROGEN SULPHATE | 96  | OP7               | +45            | +50                      |                            |         |
| 4-NITROSOPHENOL   | 100   | OP7               | +35            | +40                      |                            |         |
| 3237  | DIETHYLENEGLYCOL BIS(ALLYLCARBONATE) + DI-ISOPROPYL PEROXYDICARBONATE                                     | ≥ 88 +<br>≤ 12    | OP8            | -10                      | 0                          |         |

Remarks

- (1) Azodicarbonamide formulations which fulfil the criteria of 2.4.2.3.3.2.2. The control and emergency temperatures shall be determined by the procedure given in 7.3.7.2.
- (2) "EXPLOSIVE" subsidiary hazard label (Model No 1, see 5.2.2.2.2) required.
- (3) Azodicarbonamide formulations which fulfil the criteria of 2.4.2.3.3.2.3.
- (4) Azodicarbonamide formulations which fulfil the criteria of 2.4.2.3.3.2.3. The control and emergency temperatures shall be determined by the procedure given in 7.3.7.2.
- (5) Azodicarbonamide formulations which fulfil the criteria of 2.4.2.3.3.2.4.
- (6) Azodicarbonamide formulations which fulfil the criteria of 2.4.2.3.3.2.4. The control and emergency temperatures shall be determined by the procedure given in 7.3.7.2.
- (7) With a compatible diluent having a boiling point of not less than 150°C.
- (8) See 2.4.2.3.2.4.2.
- (9) This entry applies to mixtures of esters of 2-diazo-1-naphthol-4-sulphonic acid and 2-diazo-1-naphthol-5-sulphonic acid meeting the criteria of 2.4.2.3.3.2.4.
- (10) This entry applies to the technical mixture in n-butanol within the specified concentration limits of the (Z) isomer.
- (11) The technical compound with the specified concentration limits may contain up to 12% water and up to 1% organic impurities.

## Part 2 – Classification

2.4.2.3.2.4 Classification of self-reactive substances not listed in 2.4.2.3.2.3, packing instruction IBC520 or portable tank instruction T23 and assignment to a generic entry shall be made by the competent authority of the country of origin on the basis of a test report. Principles applying to the classification of such substances are provided in 2.4.2.3.3. The applicable classification procedures, test methods and criteria, and an example of a suitable test report, are given in the *Manual of Tests and Criteria*, part II. The statement of approval shall contain the classification and the relevant transport conditions.

- .1 Activators, such as zinc compounds, may be added to some self-reactive substances to change their reactivity. Depending on both the type and the concentration of the activator, this may result in a decrease in thermal stability and a change in explosive properties. If either of these properties is altered, the new formulation shall be assessed in accordance with this classification procedure.
- .2 Samples of self-reactive substances or formulations of self-reactive substances not listed in 2.4.2.3.2.3, for which a complete set of test results is not available and which are to be transported for further testing or evaluation, may be assigned to one of the appropriate entries for self-reactive substances type C provided the following conditions are met:
  - .1 the available data indicate that the sample would be no more dangerous than self-reactive substances type B;
  - .2 the sample is packaged in accordance with packing method OP2 (see applicable packing instruction) and the quantity per cargo transport unit is limited to 10 kg; and
  - .3 the available data indicate that the control temperature, if any, is sufficiently low to prevent any dangerous decomposition and sufficiently high to prevent any dangerous phase separation.

### 2.4.2.3.3 Principles for classification of self-reactive substances

**Note:** This section refers only to those properties of self-reactive substances which are decisive for their classification. A flow chart, presenting the classification principles in the form of a graphically arranged scheme of questions concerning the decisive properties together with the possible answers, is given in Figure 2.4.1 in chapter 2.4 of the United Nations *Recommendations on the Transport of Dangerous Goods*. These properties shall be determined experimentally. Suitable test methods with pertinent evaluation criteria are given in the *Manual of Tests and Criteria*, part II.

2.4.2.3.3.1 A self-reactive substance is regarded as possessing explosive properties when, in laboratory testing, the formulation is liable to detonate, to deflagrate rapidly or to show a violent effect when heated under confinement.

2.4.2.3.3.2 The following principles apply to the classification of self-reactive substances not listed in 2.4.2.3.2.3:

- .1 Any substance which can detonate or deflagrate rapidly, as packaged for transport, is prohibited from transport under the provisions for self-reactive substances of class 4.1 in that packaging (defined as SELF-REACTIVE SUBSTANCE TYPE A);
- .2 Any substance possessing explosive properties and which, as packaged for transport, neither detonates nor deflagrates rapidly, but is liable to undergo a thermal explosion in that package, shall also bear an “EXPLOSIVE” subsidiary hazard label (Model No. 1, see 5.2.2.2.2). Such a substance may be packaged in amounts of up to 25 kg unless the maximum quantity has to be limited to a lower amount to preclude detonation or rapid deflagration in the package (defined as SELF-REACTIVE SUBSTANCE TYPE B);
- .3 Any substance possessing explosive properties may be transported without an “EXPLOSIVE” subsidiary hazard label when the substance as packaged (maximum 50 kg) for transport cannot detonate or deflagrate rapidly or undergo a thermal explosion (defined as SELF-REACTIVE SUBSTANCE TYPE C);
- .4 Any substance which, in laboratory testing:
  - .1 detonates partially, does not deflagrate rapidly and shows no violent effect when heated under confinement; or
  - .2 does not detonate at all, deflagrates slowly and shows no violent effect when heated under confinement; or
  - .3 does not detonate or deflagrate at all and shows a medium effect when heated under confinement may be accepted for transport in packages of not more than 50 kg net mass (defined as SELF-REACTIVE SUBSTANCE TYPE D);
- .5 Any substance which, in laboratory testing, neither detonates nor deflagrates at all and shows low or no effect when heated under confinement may be accepted for transport in packages of not more than 400 kg/450 L (defined as SELF-REACTIVE SUBSTANCE TYPE E);

- .6 Any substance which, in laboratory testing, neither detonates in the cavitated state nor deflagrates at all and shows only a low or no effect when heated under confinement as well as low or no explosive power may be considered for transport in IBCs (defined as SELF-REACTIVE SUBSTANCE TYPE F); (for additional provisions see 4.1.7.2.2);
- .7 Any substance which, in laboratory testing, neither detonates in the cavitated state nor deflagrates at all and shows no effect when heated under confinement nor any explosive power shall be exempted from classification as a self-reactive substance of class 4.1 provided that the formulation is thermally stable (self-accelerating decomposition temperature 60°C to 75°C for a 50 kg package) and any diluent meets the provisions of 2.4.2.3.5 (defined as SELF-REACTIVE SUBSTANCE TYPE G). If the formulation is not thermally stable or a compatible diluent having a boiling point less than 150°C is used for desensitization, the formulation shall be defined as SELF-REACTIVE LIQUID/SOLID TYPE F.

#### 2.4.2.3.4 *Temperature control provisions*

2.4.2.3.4.1 Self-reactive substances are subject to temperature control in transport if their self-accelerating decomposition temperature (SADT) is less than or equal to 55°C. For currently assigned self-reactive substances, the control and emergency temperatures are shown in 2.4.2.3.2.3. Test methods for determining the SADT are given in the *Manual of Tests and Criteria*, part II, section 28. The test selected shall be conducted in a manner which is representative, both in size and material, of the package to be transported. The temperature control provisions are given in 7.3.7.

#### 2.4.2.3.5 *Desensitization of self-reactive substances*

2.4.2.3.5.1 In order to ensure safety during transport, self-reactive substances may be desensitized through the use of a diluent. If a diluent is used, the self-reactive substance shall be tested with the diluent present in the concentration and form used in transport.

2.4.2.3.5.2 Diluents which may allow a self-reactive substance to concentrate to a dangerous extent in the event of leakage from a package shall not be used.

2.4.2.3.5.3 The diluent shall be compatible with the self-reactive substance. In this regard, compatible diluents are those solids or liquids which have no detrimental influence on the thermal stability and hazard type of the self-reactive substance.

2.4.2.3.5.4 Liquid diluents in liquid formulations requiring temperature control shall have a boiling point of at least 60°C and a flashpoint not less than 5°C. The boiling point of the liquid shall be at least 50°C higher than the control temperature of the self-reactive substance (see 7.3.7.2).

#### 2.4.2.4 *Class 4.1 Solid desensitized explosives*

##### 2.4.2.4.1 *Definitions and properties*

2.4.2.4.1.1 Solid desensitized explosives are explosive substances which are wetted with water or alcohols or are diluted with other substances to form a homogeneous solid mixture to suppress their explosive properties. The desensitizing agent shall be distributed uniformly throughout the substance in the state in which it is to be transported. Where transport under conditions of low temperature is anticipated for substances containing or wetted with water, a suitable and compatible solvent, such as alcohol, may have to be added to lower the freezing point of the liquid. Some of these substances, when in a dry state, are classified as explosives. Where reference is made to a substance which is wetted with water, or some other liquid, it shall be permitted for transport as a class 4.1 substance only when in the wetted condition specified. Entries in the Dangerous Goods List in chapter 3.2 for solid desensitized explosives are UN 1310, UN 1320, UN 1321, UN 1322, UN 1336, UN 1337, UN 1344, UN 1347, UN 1348, UN 1349, UN 1354, UN 1355, UN 1356, UN 1357, UN 1517, UN 1571, UN 2555, UN 2556, UN 2557, UN 2852, UN 2907, UN 3317, UN 3319, UN 3344, UN 3364, UN 3365, UN 3366, UN 3367, UN 3368, UN 3369, UN 3370, UN 3376, UN 3380 and UN 3474.

2.4.2.4.2 Substances that:

- .1 have been provisionally accepted into class 1 according to Test Series 1 and 2 but exempted from class 1 by Test Series 6;
- .2 are not self-reactive substances of class 4.1;
- .3 are not substances of class 5

are also assigned to class 4.1. UN 2956, UN 3241, UN 3242 and UN 3251 are such entries.



## Part 2 – Classification

## 2.4.2.5 Class 4.1 Polymerizing substances and mixtures (stabilized)

## 2.4.2.5.1 Definitions and properties

*Polymerizing substances* are substances which, without stabilization, are liable to undergo a strongly exothermic reaction resulting in the formation of larger molecules or resulting in the formation of polymers under conditions normally encountered in transport. Such substances are considered to be polymerizing substances of class 4.1 when:

- .1 their self-accelerating polymerization temperature (SAPT) is 75°C or less under the conditions (with or without chemical stabilization as offered for transport) and in the packaging, IBC or portable tank in which the substance or mixture is to be transported;
- .2 they exhibit a heat of reaction of more than 300 J/g; and
- .3 they do not meet any other criteria for inclusion in classes 1 to 8.

A mixture meeting the criteria of a polymerizing substance shall be classified as a polymerizing substance of Class 4.1.

## 2.4.2.5.2 Polymerizing substances are subject to temperature control in transport if their self-accelerating polymerization temperature (SAPT) is:

- .1 when offered for transport in a packaging or IBC, 50°C or less in the packaging or IBC in which the substance is to be transported; or
- .2 when offered for transport in a portable tank, 45°C or less in the portable tank in which the substance is to be transported.

**Note:** Substances meeting the criteria of a polymerizing substance and also for inclusion in classes 1 to 8 are subject to the requirements of special provision 386 of chapter 3.3.

## 2.4.3 Class 4.2 – Substances liable to spontaneous combustion

## 2.4.3.1 Definitions and properties

## 2.4.3.1.1 Class 4.2 comprises:

- .1 *Pyrophoric substances*, which are substances, including mixtures and solutions (liquid or solid), which, even in small quantities, ignite within 5 minutes of coming into contact with air. These substances are the most liable to spontaneous combustion; and
- .2 *Self-heating substances*, which are substances, other than pyrophoric substances, which, in contact with air without energy supply, are liable to self-heating. These substances will ignite only when in large amounts (kilograms) and after long periods of time (hours or days).

## 2.4.3.1.2 Self-heating of a substance is a process where the gradual reaction of that substance with oxygen (in air) generates heat. If the rate of heat production exceeds the rate of heat loss, then the temperature of the substance will rise which, after an induction time, may lead to self-ignition and combustion.

## 2.4.3.1.3 Some substances may also give off toxic gases if involved in a fire.

## 2.4.3.2 Classification of class 4.2 substances

2.4.3.2.1 Solids are considered pyrophoric solids which shall be classified in class 4.2 if, in tests performed in accordance with the test method given in the *Manual of Tests and Criteria*, part III, subsection 33.4.4, the sample ignites in one of the tests.2.4.3.2.2 Liquids are considered pyrophoric liquids which shall be classified in class 4.2 if, in tests performed in accordance with the test method given in the *Manual of Tests and Criteria*, part III, subsection 33.4.5, the liquid ignites in the first part of the test, or if it ignites or chars the filter paper.

## 2.4.3.2.3 Self-heating substances

2.4.3.2.3.1 A substance shall be classified as a self-heating substance of class 4.2 if, in tests performed in accordance with the test method given in the *Manual of Tests and Criteria*, part III, subsection 33.4.6:

- .1 a positive result is obtained using a 25 mm cube sample at 140°C;
- .2 a positive result is obtained in a test using a 100 mm cube sample at 140°C and a negative result is obtained in a test using a 100 mm cube sample at 120°C and the substance is to be transported in packages with a volume of more than 3 m<sup>3</sup>;

- .3 a positive result is obtained in a test using a 100 mm cube sample at 140°C and a negative result is obtained in a test using a 100 mm cube sample at 100°C and the substance is to be transported in packages with a volume of more than 450 L;
- .4 a positive result is obtained in a test using a 100 mm cube sample at 140°C and a positive result is obtained using a 100 mm cube sample at 100°C.

**Note:** Self-reactive substances, giving also a positive result with this test method shall not be classified in class 4.2 but in class 4.1 (see 2.4.2.3.1.1).

2.4.3.2.3.2 A substance shall not be classified in class 4.2 if:

- .1 a negative result is obtained in a test using a 100 mm cube sample at 140°C;
- .2 a positive result is obtained in a test using a 100 mm cube sample at 140°C and a negative result is obtained in a test using a 25 mm cube sample at 140°C, a negative result is obtained in a test using a 100 mm cube sample at 120°C and the substance is to be transported in packages with a volume not more than 3 m<sup>3</sup>;
- .3 a positive result is obtained in a test using a 100 mm cube sample at 140°C and a negative result is obtained in a test using a 25 mm cube sample at 140°C, a negative result is obtained in a test using a 100 mm cube sample at 100°C and the substance is to be transported in packages with a volume not more than 450 L.

### 2.4.3.3 Assignment of packing groups

2.4.3.3.1 Packing group I shall be assigned to all pyrophoric solids and liquids.

2.4.3.3.2 Packing group II shall be assigned to self-heating substances which give a positive result in a test using a 25 mm cube sample at 140°C.

2.4.3.3.3 Packing group III shall be assigned to self-heating substances if:

- .1 a positive result is obtained in a test using a 100 mm cube sample at 140°C and a negative result is obtained in a test using a 25 mm cube sample at 140°C and the substance is to be transported in packages with a volume of more than 3 m<sup>3</sup>;
- .2 a positive result is obtained in a test using a 100 mm cube sample at 140°C and a negative result is obtained in a test using a 25 mm cube sample at 140°C, a positive result is obtained in a test using a 100 mm cube sample at 120°C and the substance is to be transported in packages with a volume of more than 450 L;
- .3 a positive result is obtained in a test using a 100 mm cube sample at 140°C and a negative result is obtained in a test using a 25 mm cube sample at 140°C and a positive result is obtained in a test using a 100 mm cube sample at 100°C.

## 2.4.4 Class 4.3 – Substances which, in contact with water, emit flammable gases

### 2.4.4.1 Definitions and properties

2.4.4.1.1 For the purpose of this Code, the substances in this class are either liquids or solids which, by interaction with water, are liable to become spontaneously flammable or to give off flammable gases in dangerous quantities.

2.4.4.1.2 Certain substances, in contact with water, may emit flammable gases that can form explosive mixtures with air. Such mixtures are easily ignited by all ordinary sources of ignition, for example naked lights, sparking handtools or unprotected lamps. The resulting blast wave and flames may endanger people and the environment. The test method referred to in 2.4.4.2 is used to determine whether the reaction of a substance with water leads to the development of a dangerous amount of gases which may be flammable. This test method shall not be applied to pyrophoric substances.

### 2.4.4.2 Classification of class 4.3 substances

2.4.4.2.1 Substances which, in contact with water, emit flammable gases shall be classified in class 4.3 if, in tests performed in accordance with the test method given in the *Manual of Tests and Criteria*, part III, 33.5:

- .1 spontaneous ignition takes place in any step of the test procedure; or
- .2 there is an evolution of a flammable gas at a rate greater than 1 L per kilogram of the substance per hour.



## Part 2 – Classification

---

### 2.4.4.3 Assignment of packing groups

2.4.4.3.1 Packing group I shall be assigned to any substance which reacts vigorously with water at ambient temperatures and demonstrates generally a tendency for the gas produced to ignite spontaneously, or which reacts readily with water at ambient temperatures such that the rate of evolution of flammable gas is equal to or greater than 10 L per kilogram of substance over any one minute.

2.4.4.3.2 Packing group II shall be assigned to any substance which reacts readily with water at ambient temperatures such that the maximum rate of evolution of flammable gas is equal to or greater than 20 litres per kilogram of substance per hour, and which does not meet the criteria for packing group I.

2.4.4.3.3 Packing group III shall be assigned to any substance which reacts slowly with water at ambient temperatures such that the maximum rate of evolution of flammable gas is greater than 1 litre per kilogram of substance per hour, and which does not meet the criteria for packing groups I or II.

### 2.4.5 Classification of organometallic substances

Depending on their properties, organometallic substances may be classified in classes 4.2 or 4.3, as appropriate, in accordance with the following flowchart:

Flowchart scheme for organometallic substances<sup>1,2</sup>

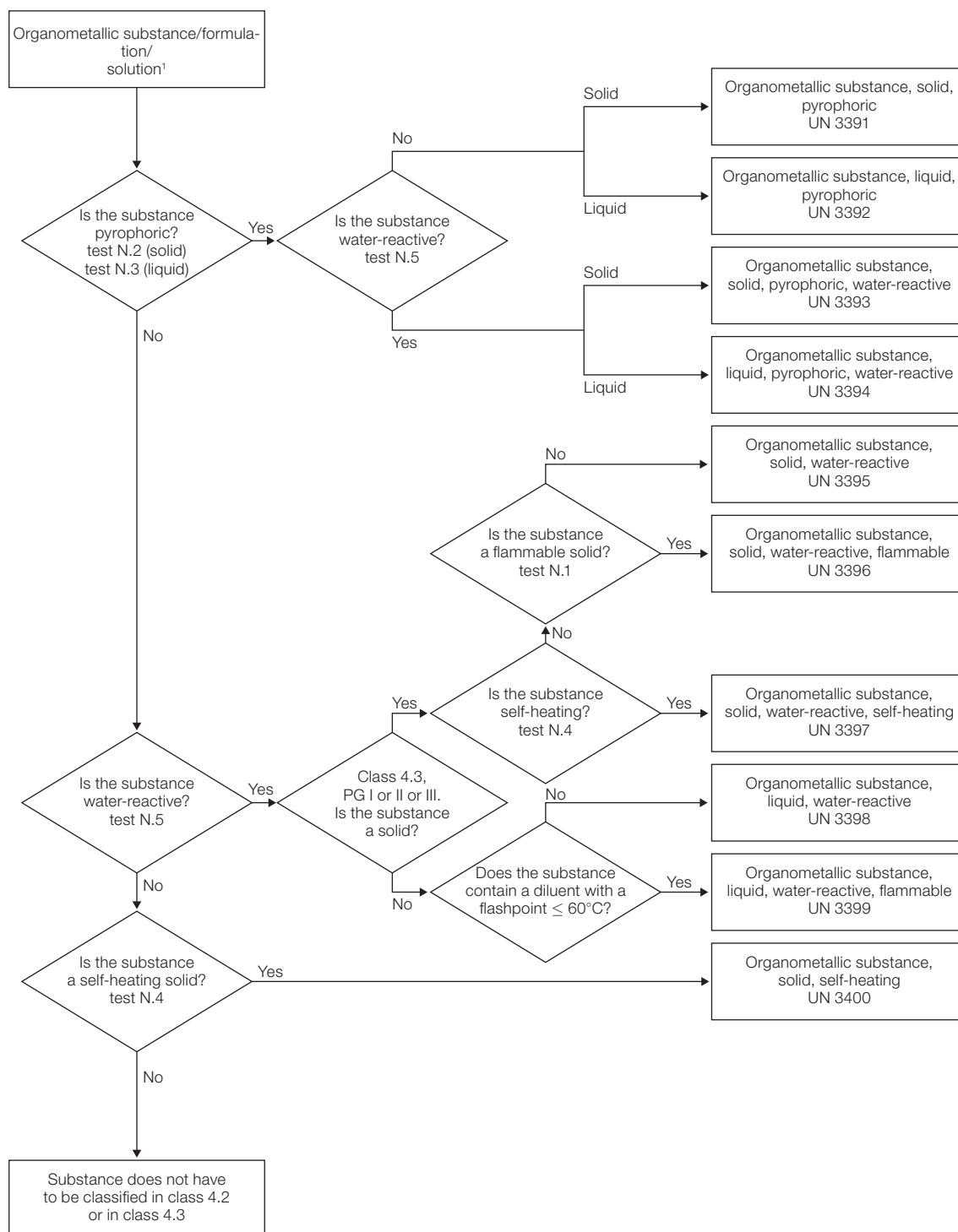

<sup>1</sup> If applicable and testing is relevant, taking into account reactivity properties, class 6.1 and class 8 properties shall be considered according to the Precedence of hazards in table 2.0.3.6.

<sup>2</sup> Test methods N.1 to N.5 can be found in the *Manual of Tests and Criteria*, part III, section 33.



## Chapter 2.5

### Class 5 – Oxidizing substances and organic peroxides

#### 2.5.0 Introductory note

Because of the differing properties exhibited by dangerous goods within classes 5.1 and 5.2, it is impracticable to establish a single criterion for classification in either class. Tests and criteria for assignment to the two classes are addressed in this chapter.

#### 2.5.1 Definitions and general provisions

In this Code, class 5 is divided into two classes as follows:

##### Class 5.1 – Oxidizing substances

Substances which, while in themselves not necessarily combustible, may, generally by yielding oxygen, cause, or contribute to, the combustion of other material. Such substances may be contained in an article;

##### Class 5.2 – Organic peroxides

Organic substances which contain the bivalent –O–O– structure and may be considered derivatives of hydrogen peroxide, where one or both of the hydrogen atoms have been replaced by organic radicals. Organic peroxides are thermally unstable substances which may undergo exothermic self-accelerating decomposition. In addition, they may have one or more of the following properties:

- be liable to explosive decomposition;
- burn rapidly;
- be sensitive to impact or friction;
- react dangerously with other substances;
- cause damage to the eyes.

#### 2.5.2 Class 5.1 – Oxidizing substances

**Note 1:** For the classification of oxidizing substances to class 5.1, in the event of divergence between test results and known experience, judgement based on known experience shall take precedence over test results.

**Note 2:** By exception, solid ammonium nitrate based fertilizers shall be classified in accordance with the procedure as set out in the *Manual of Tests and Criteria*, part III, section 39.

##### 2.5.2.1 Properties

2.5.2.1.1 Substances of class 5.1 in certain circumstances directly or indirectly evolve oxygen. For this reason, oxidizing substances increase the risk and intensity of fire in combustible material with which they come into contact.

2.5.2.1.2 Mixtures of oxidizing substances with combustible material and even with material such as sugar, flour, edible oils, mineral oils, etc., are dangerous. These mixtures are readily ignited, in some cases by friction or impact. They may burn violently and may lead to explosion.

2.5.2.1.3 There will be a violent reaction between most oxidizing substances and liquid acids, evolving toxic gases. Toxic gases may also be evolved when certain oxidizing substances are involved in a fire.

2.5.2.1.4 The above-mentioned properties are, in general, common to all substances in this class. Additionally, some substances possess specific properties, which shall be taken into account in transport. These properties are shown in the Dangerous Goods List in chapter 3.2.

## 2.5.2.2 Oxidizing solids

### 2.5.2.2.1 Classification of solid substances of class 5.1

2.5.2.2.1.1 Tests are performed to measure the potential for the solid substance to increase the burning rate or burning intensity of a combustible substance when the two are thoroughly mixed. The procedure is given in the *Manual of Tests and Criteria*, part III, subsection 34.4.1 (test O.1) or alternatively, in subsection 34.4.3 (test O.3). Tests are conducted on the substance to be evaluated mixed with dry fibrous cellulose in mixing ratios of 1:1 and 4:1, by mass, of sample to cellulose. The burning characteristics of the mixtures are compared:

- .1 in the test O.1, with the standard 3:7 mixture, by mass, of potassium bromate to cellulose. If the burning time is equal to or less than this standard mixture, the burning times shall be compared with those from the packing group I or II reference standards, 3:2 and 2:3 ratios, by mass, of potassium bromate to cellulose, respectively; or
- .2 in the test O.3, with the standard 1:2 mixture, by mass, of calcium peroxide to cellulose. If the burning rate is equal to or greater than this standard mixture, the burning rates shall be compared with those from the packing group I or II reference standards, 3:1 and 1:1 ratios, by mass, of calcium peroxide to cellulose, respectively.

2.5.2.2.1.2 The classification test results are assessed on the basis of:

- .1 the comparison of the mean burning time (for the test O.1) or burning rate (for the test O.3) with those of the reference mixtures; and
- .2 whether the mixture of substance and cellulose ignites and burns.

2.5.2.2.1.3 A solid substance is classified in class 5.1 if the 4:1 or 1:1 sample-to-cellulose ratio (by mass) tested, exhibits:

- .1 in the test O.1, a mean burning time equal to or less than the mean burning time of a 3:7 mixture (by mass) of potassium bromate and cellulose; or
- .2 in the test O.3, a mean burning rate equal to or greater than the mean burning rate of a 1:2 mixture (by mass) of calcium peroxide and cellulose.

### 2.5.2.2.2 Assignment of packing groups

Solid oxidizing substances are assigned to a packing group according to one of the test procedures in the *Manual of Tests and Criteria*, part III, subsection 34.4.1 (test O.1) or subsection 34.4.3 (test O.3), in accordance with the following criteria:

- .1 Test O.1:
  - .1 Packing group I: any substance which, in the 4:1 or 1:1 sample-to-cellulose ratio (by mass) tested, exhibits a mean burning time less than the mean burning time of a 3:2 mixture, by mass, of potassium bromate and cellulose;
  - .2 Packing group II: any substance which, in the 4:1 or 1:1 sample-to-cellulose ratio (by mass) tested, exhibits a mean burning time equal to or less than the mean burning time of a 2:3 mixture (by mass) of potassium bromate and cellulose, and the criteria for packing group I are not met;
  - .3 Packing group III: any substance which, in the 4:1 or 1:1 sample-to-cellulose ratio (by mass) tested, exhibits a mean burning time equal to or less than the mean burning time of a 3:7 mixture (by mass) of potassium bromate and cellulose, and the criteria for packing groups I and II are not met;
  - .4 Not class 5.1: any substance which, in both the 4:1 and 1:1 sample-to-cellulose ratio (by mass) tested, does not ignite and burn, or exhibits mean burning times greater than that of a 3:7 mixture (by mass) of potassium bromate and cellulose.
- .2 Test O.3:
  - .1 Packing group I: any substance which, in the 4:1 or 1:1 sample-to-cellulose ratio (by mass) tested, exhibits a mean burning rate greater than the mean burning rate of a 3:1 mixture (by mass) of calcium peroxide and cellulose;
  - .2 Packing group II: any substance which, in the 4:1 or 1:1 sample-to-cellulose ratio (by mass) tested, exhibits a mean burning rate equal to or greater than the mean burning rate of a 1:1 mixture (by mass) of calcium peroxide and cellulose, and the criteria for packing group I are not met;
  - .3 Packing group III: any substance which, in the 4:1 or 1:1 sample-to-cellulose ratio (by mass) tested, exhibits a mean burning rate equal to or greater than the mean burning rate of a 1:2 mixture (by mass) of calcium peroxide and cellulose, and the criteria for packing groups I and II are not met;
  - .4 Not class 5.1: any substance which, in both the 4:1 and 1:1 sample-to-cellulose ratio (by mass) tested, does not ignite and burn, or exhibits a mean burning rate less than the mean burning rate of a 1:2 mixture (by mass) of calcium peroxide and cellulose.

## Part 2 – Classification

### 2.5.2.3 Oxidizing liquids

#### 2.5.2.3.1 Classification of liquid substances of class 5.1

2.5.2.3.1.1 A test is performed to determine the potential for a liquid substance to increase the burning rate or burning intensity of a combustible substance or for spontaneous ignition to occur when the two are thoroughly mixed. The procedure is given in the *Manual of Tests and Criteria*, part III, 34.4.2 (test O.2). It measures the pressure rise time during combustion. Whether a liquid is an oxidizing substance of class 5.1 and, if so, whether packing group I, II or III shall be assigned, is decided on the basis of the test result (see also Precedence of hazard characteristics in 2.0.3).

2.5.2.3.1.2 The classification test results are assessed on the basis of:

- .1 whether the mixture of substance and cellulose spontaneously ignites;
- .2 the comparison of the mean time taken for the pressure to rise from 690 kPa to 2070 kPa gauge with those of the reference substances.

2.5.2.3.1.3 A liquid substance is classified in class 5.1 if the 1:1 mixture, by mass, of substance and cellulose tested exhibits a mean pressure rise time less than or equal to the mean pressure rise time of a 1:1 mixture, by mass, of 65% aqueous nitric acid and cellulose.

#### 2.5.2.3.2 Assignment of packing groups

2.5.2.3.2.1 Liquid oxidizing substances are assigned to a packing group according to the test procedure in the *Manual of Tests and Criteria*, part III, 34.4.2, in accordance with the following criteria:

- .1 Packing group I: any substance which, in the 1:1 mixture (by mass) of substance and cellulose tested, spontaneously ignites; or the mean pressure rise time of a 1:1 mixture (by mass) of substance and cellulose is less than that of a 1:1 mixture (by mass) of 50% perchloric acid and cellulose;
- .2 Packing group II: any substance which, in the 1:1 mixture (by mass) of substance and cellulose tested, exhibits a mean pressure rise time less than or equal to the mean pressure rise time of a 1:1 mixture (by mass) of 40% aqueous sodium chlorate solution and cellulose; and the criteria for packing group I are not met;
- .3 Packing group III: any substance which, in the 1:1 mixture (by mass) of substance and cellulose tested, exhibits a mean pressure rise time less than or equal to the mean pressure rise time of a 1:1 mixture (by mass) of 65% aqueous nitric acid and cellulose; and the criteria for packing groups I and II are not met;
- .4 Not classified as class 5.1: any substance which, in the 1:1 mixture (by mass) of substance and cellulose tested, exhibits a pressure rise of less than 2070 kPa gauge; or exhibits a mean pressure rise time greater than the mean pressure rise time of a 1:1 mixture (by mass) of 65% aqueous nitric acid and cellulose.

### 2.5.3 Class 5.2 – Organic peroxides

#### 2.5.3.1 Properties

2.5.3.1.1 Organic peroxides are liable to exothermic decomposition at normal or elevated temperatures. The decomposition can be initiated by heat, contact with impurities (such as acids, heavy-metal compounds, amines), friction or impact. The rate of decomposition increases with temperature and varies with the organic peroxide formulation. Decomposition may result in the evolution of harmful, or flammable, gases or vapours. For certain organic peroxides the temperature shall be controlled during transport. Some organic peroxides may decompose explosively, particularly if confined. This characteristic may be modified by the addition of diluents or by the use of appropriate packagings. Many organic peroxides burn vigorously.

2.5.3.1.2 Contact of organic peroxides with the eyes is to be avoided. Some organic peroxides will cause serious injury to the cornea, even after brief contact, or will be corrosive to the skin.

#### 2.5.3.2 Classification of organic peroxides

2.5.3.2.1 Any organic peroxide shall be considered for classification in class 5.2, unless the organic peroxide formulation contains:

- .1 not more than 1.0% available oxygen from the organic peroxides when containing not more than 1.0% hydrogen peroxide; or
- .2 not more than 0.5% available oxygen from the organic peroxides when containing more than 1.0% but not more than 7.0% hydrogen peroxide.

**Note:** The available oxygen content (%) of an organic peroxide formulation is given by the formula:

$$16 \times \Sigma(n_i \times c_i/m_i)$$

where:

- $n_i$  = number of peroxygen groups per molecule of organic peroxide  $i$ ;
- $c_i$  = concentration (mass %) of organic peroxide  $i$ ;
- $m_i$  = molecular mass of organic peroxide  $i$ .

- 2.5.3.2.2** Organic peroxides are classified into seven types according to the degree of danger they present. The types of organic peroxide range from type A, which may not be accepted for transport in the packaging in which it is tested, to type G, which is not subject to the provisions for organic peroxides of class 5.2. The classification of types B to F is directly related to the maximum quantity allowed in one packaging.
- 2.5.3.2.3** Organic peroxides permitted for transport in packagings are listed in 2.5.3.2.4, those permitted for transport in IBCs are listed in packing instruction IBC520 and those permitted for transport in portable tanks are listed in portable tank instruction T23. For each permitted substance listed, the generic entry of the Dangerous Goods List (UN 3101 to UN 3120) is assigned, appropriate subsidiary hazards and remarks providing relevant transport information are given. The generic entries specify:
- .1 organic peroxide type (B to F);
  - .2 physical state (liquid or solid); and
  - .3 temperature control, when required (see 2.5.3.4).
- 2.5.3.2.3.1** Mixtures of the listed formulations may be classified as the same type of organic peroxide as that of the most dangerous component and be transported under the conditions of transport given for this type. However, as two stable components can form a thermally less stable mixture, the self-accelerating decomposition temperature (SADT) of the mixture shall be determined and, if necessary, temperature control applied as required by 2.5.3.4.

Part 2 – Classification



2.5.3.2.4 List of currently assigned organic peroxides in packagings

△ **Note:** Packing Method codes “OP1” to “OP8” refer to packing methods in packing instruction P520. Peroxides to be transported shall fulfil the classification and the control and emergency temperatures (derived from the SADT) as listed. For substances permitted in IBCs, see packing instruction IBC520, and for those permitted in tanks, see portable tank instruction T23. The formulations not listed in this subsection but listed in packing instruction IBC520 of 4.1.4.2 and in portable tank instruction T23 of 4.2.5.2.6 may also be transported packed in accordance with packing method OP8 of packing instruction P520 of 4.1.4.1, with the same control and emergency temperatures, if applicable.

| Number (generic entry)   | ORGANIC PEROXIDE   | Concentration (%) | Diluent type A (%) | Diluent type B (%) <sup>(1)</sup> | Inert solid (%) | Water (%) | Packing method | Control temperature (°C) | Emergency temperature (°C) | Subsidiary hazards and remarks |
|--|--|-------------------|--------------------|-----------------------------------|-----------------|-----------|----------------|--------------------------|----------------------------|--------------------------------|
| 3101   | <i>tert</i> -BUTYL PEROXYACETATE                               | > 52 – 77         | ≥ 23               |                                   |                 |           | OP5            |                          |                            | (3)                            |
|  | 1,1-DI-( <i>tert</i> -BUTYLPEROXY)CYCLOHEXANE                  | > 80 – 100        |                    |                                   |                 |           | OP5            |                          |                            | (3)                            |
|  | 1,1-DI-( <i>tert</i> -BUTYLPEROXY)-3,3,5-TRIMETHYL-CYCLOHEXANE | > 90 – 100        |                    |                                   |                 |           | OP5            |                          |                            | (3)                            |
|  | METHYL ETHYL KETONE PEROXIDE(S)                                | see remark (8)    | ≥ 48               |                                   |                 |           | OP5            |                          |                            | (3) (8) (13)                   |
|  | 2,5-DIMETHYL-2,5-DI-( <i>tert</i> -BUTYLPEROXY)-HEXYNE-3       | > 86 – 100        |                    |                                   |                 |           | OP5            |                          |                            | (3)                            |
|  | <i>tert</i> -BUTYL MONOPEROXYMALEATE                           | > 52 – 100        |                    |                                   |                 |           | OP5            |                          |                            | (3)                            |
| 3102   | 3-CHLOROPEROXYBENZOIC ACID                                     | > 57 – 86         |                    |                                   | ≥ 14            |           | OP1            |                          |                            | (3)                            |
|  | DIBENZOYL PEROXIDE   | > 52 – 100        |                    |                                   | ≤ 48            |           | OP2            |                          |                            | (3)                            |
|  | DIBENZOYL PEROXIDE   | > 77 – 94         |                    |                                   |                 | ≥ 6       | OP4            |                          |                            | (3)                            |
|  | DI-4-CHLOROBENZOYL PEROXIDE                                    | ≤ 77              |                    |                                   |                 | ≥ 23      | OP5            |                          |                            | (3)                            |
|  | DI-2,4-DICHLOROBENZOYL PEROXIDE                                | ≤ 77              |                    |                                   |                 | ≥ 23      | OP5            |                          |                            | (3)                            |
|  | 2,2-DIHYDROPEROXYPROPANE                                       | ≤ 27              |                    |                                   |                 |           | OP5            |                          |                            | (3)                            |
|  | 2,5-DIMETHYL-2,5-DI-(BENZOYLPEROXY)HEXANE                      | > 82 – 100        |                    |                                   | ≥ 73            |           | OP5            |                          |                            | (3)                            |
|  | DI-(2-PHENOXYETHYL) PEROXYDICARBONATE                          | > 85 – 100        |                    |                                   |                 |           | OP5            |                          |                            | (3)                            |
|  | DISUCCINIC ACID PEROXIDE                                       | > 72 – 100        |                    |                                   |                 |           | OP4            |                          |                            | (3) (17)                       |
|  | <i>tert</i> -AMYL PEROXYBENZOATE                               | ≤ 100             |                    |                                   |                 |           | OP5            |                          |                            |                                |
|  | <i>tert</i> -AMYLPEROXY ISOPROPYL CARBONATE                    | ≤ 77              | ≥ 23               |                                   |                 |           | OP5            |                          |                            |                                |
|  | <i>n</i> -BUTYL 4,4-DI-( <i>tert</i> -BUTYLPEROXY)VALERATE     | > 52 – 100        |                    |                                   |                 |           | OP5            |                          |                            |                                |
| <i>tert</i> -BUTYL HYDROPEROXIDE                                   | > 79 – 90  |                   |                    |                                   |                 | OP5       |                |                          | (13)                       |                                |
| <i>tert</i> -BUTYL HYDROPEROXIDE + Di- <i>tert</i> -BUTYL PEROXIDE | < 82 + > 9   |                   |                    |                                   |                 | OP5       |                |                          | (13)                       |                                |
| 3103   | <i>tert</i> -BUTYL MONOPEROXYMALEATE                           | ≤ 52              | ≥ 48               |                                   |                 |           | OP6            |                          |                            |                                |
|  | <i>tert</i> -BUTYL PEROXYACETATE                               | > 32 – 52         | ≥ 48               |                                   |                 |           | OP6            |                          |                            |                                |
|  | <i>tert</i> -BUTYL PEROXYBENZOATE                              | > 77 – 100        |                    |                                   |                 |           | OP5            |                          |                            |                                |
|  | <i>tert</i> -BUTYLPEROXY ISOPROPYL CARBONATE                   | ≤ 77              | ≥ 23               |                                   |                 |           | OP5            |                          |                            |                                |
|  | <i>tert</i> -BUTYLPEROXY-2-METHYLBENZOATE                      | ≤ 100             |                    |                                   |                 |           | OP5            |                          |                            |                                |

Chapter 2.5 – Class 5 – Oxidizing substances and organic peroxides

| Number (generic entry) | ORGANIC PEROXIDE   | Concentration (%)                | Diluent type A (%) | Diluent type B (%) <sup>(1)</sup> | Inert solid (%) | Water (%) | Packing method | Control temperature (°C) | Emergency temperature (°C) | Subsidiary hazards and remarks |
|------------------------|--|----------------------------------|--------------------|-----------------------------------|-----------------|-----------|----------------|--------------------------|----------------------------|--------------------------------|
| 3103<br>(cont.)        | 1,1-DI-( <i>tert</i> -AMYLPEROXY)CYCLOHEXANE                   | ≤ 82                             | ≥ 18               |                                   |                 |           | OP6            |                          |                            |                                |
|                        | 2,2-DI-( <i>tert</i> -BUTYLPEROXY)BUTANE                       | ≤ 52                             | ≥ 48               |                                   |                 |           | OP6            |                          |                            |                                |
|                        | 1,6-DI-( <i>tert</i> -BUTYLPEROXYCARBONYLOXY)-HEXANE           | ≤ 72                             | ≥ 28               |                                   |                 |           | OP5            |                          |                            |                                |
|                        | 1,1-DI-( <i>tert</i> -BUTYLPEROXY)CYCLOHEXANE                  | > 52 – 80                        | ≥ 20               |                                   |                 |           | OP5            |                          |                            |                                |
|                        | 1,1-DI-( <i>tert</i> -BUTYLPEROXY)CYCLOHEXANE                  | ≤ 72                             | ≥ 28               |                                   |                 |           | OP5            |                          |                            | (30)                           |
|                        | 1,1-DI-( <i>tert</i> -BUTYLPEROXY)-3,3,5-TRIMETHYL-CYCLOHEXANE | > 57 – 90                        | ≥ 10               |                                   |                 |           | OP5            |                          |                            |                                |
|                        | 1,1-DI-( <i>tert</i> -BUTYLPEROXY)-3,3,5-TRIMETHYL-CYCLOHEXANE | ≤ 77                             | ≥ 23               |                                   |                 |           | OP5            |                          |                            |                                |
|                        | 1,1-DI-( <i>tert</i> -BUTYLPEROXY)-3,3,5-TRIMETHYL-CYCLOHEXANE | ≤ 90                             | ≥ 10               |                                   |                 |           | OP5            |                          |                            | (30)                           |
|                        | 2,5-DIMETHYL-2,5-DI-( <i>tert</i> -BUTYLPEROXY)HEXANE          | > 90 – 100                       |                    |                                   |                 |           | OP5            |                          |                            |                                |
|                        | 2,5-DIMETHYL-2,5-DI-( <i>tert</i> -BUTYLPEROXY)-HEXYNE-3       | > 52 – 86                        | ≥ 14               |                                   |                 |           | OP5            |                          |                            | (26)                           |
| 3104                   | ETHYL 3,3-DI-( <i>tert</i> -BUTYLPEROXY)BUTYRATE               | > 77 – 100                       |                    |                                   |                 |           | OP5            |                          |                            |                                |
|                        | ORGANIC PEROXIDE, LIQUID, SAMPLE                               |                                  |                    |                                   |                 |           | OP2            |                          |                            | (11)                           |
|                        | CYCLOHEXANONE PEROXIDE(S)                                      | ≤ 91                             |                    |                                   |                 |           | OP6            |                          |                            | (13)                           |
|                        | DI-2,4-DICHLOROBENZOYL PEROXIDE                                | ≤ 52 as a paste with silicon oil |                    |                                   |                 | ≥ 9       | OP5            |                          |                            |                                |
|                        | DIBENZOYL PEROXIDE   | ≤ 77                             |                    |                                   |                 | ≥ 23      | OP6            |                          |                            |                                |
|                        | 2,5-DIMETHYL-2,5-DI(BENZOYLPEROXY)HEXANE                       | ≤ 82                             |                    |                                   |                 | ≥ 18      | OP5            |                          |                            |                                |
|                        | 2,5-DIMETHYL-2,5-DIHYDROPEROXYHEXANE                           | ≤ 82                             |                    |                                   |                 | ≥ 18      | OP6            |                          |                            |                                |
|                        | ORGANIC PEROXIDE, SOLID, SAMPLE                                |                                  |                    |                                   |                 |           | OP2            |                          |                            | (11)                           |
|                        | ACETYL ACETONE PEROXIDE  | ≤ 42                             | ≥ 48               |                                   |                 |           | OP7            |                          |                            | (2)                            |
|                        | <i>tert</i> -AMYL PEROXYACETATE                                | ≤ 62                             | ≥ 38               |                                   |                 |           | OP7            |                          |                            |                                |
| 3105                   | <i>tert</i> -AMYL PEROXY-2-ETHYLHEXYL CARBONATE                | ≤ 100                            |                    |                                   |                 |           | OP7            |                          |                            |                                |
|                        | <i>tert</i> -AMYL PEROXY-3,5,5-TRIMETHYLHEXANOATE              | ≤ 100                            |                    |                                   |                 |           | OP7            |                          |                            |                                |
|                        | <i>tert</i> -BUTYL HYDROPEROXIDE                               | ≤ 80                             | ≥ 20               |                                   |                 |           | OP7            |                          |                            | (4) (13)                       |
|                        | <i>tert</i> -BUTYL PEROXYBENZOATE                              | > 52 – 77                        | ≥ 23               |                                   |                 |           | OP7            |                          |                            |                                |
|                        | <i>tert</i> -BUTYL PEROXYBUTYL FUMARATE                        | ≤ 52                             | ≥ 48               |                                   |                 |           | OP7            |                          |                            |                                |
|                        | <i>tert</i> -BUTYL PEROXYCROTONATE                             | ≤ 77                             | ≥ 23               |                                   |                 |           | OP7            |                          |                            |                                |
|                        | <i>tert</i> -BUTYL PEROXY-2-ETHYLHEXYLCARBONATE                | ≤ 100                            |                    |                                   |                 |           | OP7            |                          |                            |                                |
|                        | <i>tert</i> -BUTYLPEROXY ISOPROPYLCARBONATE                    | ≤ 62                             | ≥ 38               |                                   |                 |           | OP7            |                          |                            |                                |

△



Part 2 – Classification

| Number (generic entry)                             | ORGANIC PEROXIDE   | Concentration (%) | Diluent type A (%) | Diluent type B (%) <sup>(1)</sup> | Inert solid (%) | Water (%) | Packing method | Control temperature (°C) | Emergency temperature (°C) | Subsidiary hazards and remarks |          |
|--|--|-------------------|--------------------|-----------------------------------|-----------------|-----------|----------------|--------------------------|----------------------------|--------------------------------|----------|
| 3105<br>(cont.)                                    | 1-(2- <i>tert</i> -BUTYLPEROXY ISOPROPYL)-3-ISOPROPENYLBENZENE                             | ≤ 77              | ≥ 23               |                                   |                 |           | OP7            |                          |                            |                                |          |
|  | <i>tert</i> -BUTYL PEROXY-3,5,5-TRIMETHYLHEXANOATE   | > 37 – 100        |                    |                                   |                 |           | OP7            |                          |                            |                                |          |
|  | CYCLOHEXANONE PEROXIDE(S)  | ≤ 72              | ≥ 28               |                                   |                 |           | OP7            |                          |                            | (5)                            |          |
|  | 2,2-DI-( <i>tert</i> -AMYLPEROXY)BUTANE  | ≤ 57              | ≥ 43               |                                   |                 |           | OP7            |                          |                            |                                |          |
|  | DI- <i>tert</i> -BUTYL PEROXYAZELATE   | ≤ 52              | ≥ 48               |                                   |                 |           | OP7            |                          |                            |                                |          |
|  | 1,1-DI-( <i>tert</i> -BUTYLPEROXY)CYCLOHEXANE  | > 42 – 52         | ≥ 48               |                                   |                 |           | OP7            |                          |                            |                                |          |
|  | 1,1-DI-( <i>tert</i> -BUTYLPEROXY)CYCLOHEXANE + <i>tert</i> -BUTYL PEROXY-2-ETHYLHEXANOATE | ≤ 43 + ≤ 16       | ≥ 41               |                                   |                 |           | OP7            |                          |                            |                                |          |
|  | DI-( <i>tert</i> -BUTYLPEROXY)PHTHALATE  | > 42 – 52         | ≥ 48               |                                   |                 |           | OP7            |                          |                            |                                |          |
|  | 2,2-DI-( <i>tert</i> -BUTYLPEROXY)PROPANE  | ≤ 52              | ≥ 48               |                                   |                 |           | OP7            |                          |                            |                                |          |
|  | 2,5-DIMETHYL-2,5-DI-( <i>tert</i> -BUTYLPEROXY)HEXANE                                      | > 52 – 90         | ≥ 10               |                                   |                 |           | OP7            |                          |                            |                                |          |
|  | 2,5-DIMETHYL-2,5-DI-(3,5,5-TRIMETHYLHEXANOYLPEROXY)HEXANE                                  | ≤ 77              | ≥ 23               |                                   |                 |           | OP7            |                          |                            |                                |          |
|  | ETHYL 3,3-DI-( <i>tert</i> -AMYLPEROXY)BUTYRATE  | ≤ 67              | ≥ 33               |                                   |                 |           | OP7            |                          |                            |                                |          |
|  | ETHYL 3,3-DI-( <i>tert</i> -BUTYLPEROXY)BUTYRATE   | ≤ 77              | ≥ 23               |                                   |                 |           | OP7            |                          |                            | (13)                           |          |
|  | <i>p</i> -MENTHYL HYDROPEROXIDE  | > 72 – 100        |                    |                                   |                 |           | OP7            |                          |                            |                                | (9)      |
|  | METHYL ETHYL KETONE PEROXIDE(S)  | see remark (9)    | ≥ 55               |                                   |                 |           | OP7            |                          |                            |                                | (33)(34) |
|  | METHYL ETHYL KETONE PEROXIDE(S)  | see remark (33)   | ≥ 41               |                                   |                 |           | OP8            |                          |                            |                                | (22)     |
| METHYL ISOBUTYL KETONE PEROXIDE(S)                 | ≤ 62   | ≥ 19              |                    |                                   |                 | OP7       |                |                          |                            | (13)(14)(19)                   |          |
| PEROXYACETIC ACID, TYPE D, stabilized              | ≤ 43   |                   |                    |                                   |                 | OP7       |                |                          |                            | (13)                           |          |
| PINANYL HYDROPEROXIDE                              | > 56 – 100   |                   |                    |                                   |                 | OP7       |                |                          |                            | (28)                           |          |
| 1,1,3,3-TETRAMETHYLBUTYL HYDROPEROXIDE             | ≤ 100  |                   |                    |                                   |                 | OP7       |                |                          |                            |                                |          |
| 3,6,9-TRIETHYL-3,6,9-TRIMETHYL-1,4,7-TRIPEROXONANE | ≤ 42   | ≥ 58              |                    |                                   |                 | OP7       |                |                          |                            |                                |          |
| 3106   | ACETYL ACETONE PEROXIDE  | ≤ 32 as a paste   |                    |                                   |                 |           | OP7            |                          |                            | (20)                           |          |
|  | <i>tert</i> -BUTYL PEROXYBENZOATE  | ≤ 52              |                    |                                   | ≥ 48            |           | OP7            |                          |                            |                                |          |
|  | <i>tert</i> -BUTYL PEROXY-2-ETHYLHEXANOATE + 2,2-DI-( <i>tert</i> -BUTYLPEROXY)BUTANE      | ≤ 12 + ≤ 14       | ≥ 14               |                                   | ≥ 60            |           | OP7            |                          |                            |                                |          |
|  | <i>tert</i> -BUTYLPEROXY STEARYLCARBONATE  | ≤ 100             |                    |                                   |                 |           | OP7            |                          |                            |                                |          |
|  | <i>tert</i> -BUTYL PEROXY-3,5,5-TRIMETHYLHEXANOATE   | ≤ 42              |                    |                                   | ≥ 58            |           | OP7            |                          |                            |                                |          |
|  | 3-CHLOROPEROXYBENZOIC ACID   | ≤ 57              |                    |                                   | ≥ 3             | ≥ 40      | OP7            |                          |                            |                                |          |
|  | 3-CHLOROPEROXYBENZOIC ACID   | ≤ 77              |                    |                                   | ≥ 6             | ≥ 17      | OP7            |                          |                            |                                |          |
|  | CYCLOHEXANONE PEROXIDE(S)  | ≤ 72 as a paste   |                    |                                   |                 |           | OP7            |                          |                            |                                | (5)(20)  |
|  | DIBENZOYL PEROXIDE   | ≤ 62              |                    |                                   |                 | ≥ 28      | ≥ 10           | OP7                      |                            |                                |          |

Chapter 2.5 – Class 5 – Oxidizing substances and organic peroxides

| Number (generic entry)  | ORGANIC PEROXIDE  | Concentration (%)              | Diluent type A (%) | Diluent type B (%) <sup>(1)</sup> | Inert solid (%) | Water (%) | Packing method | Control temperature (°C) | Emergency temperature (°C) | Subsidiary hazards and remarks |
|---|---|--------------------------------|--------------------|-----------------------------------|-----------------|-----------|----------------|--------------------------|----------------------------|--------------------------------|
| 3106<br>(cont.)   | DIBENZOYL PEROXIDE  | > 52 – 62 as a paste           |                    |                                   | ≥ 48            |           | OP7            |                          |                            | (20)                           |
|   | DIBENZOYL PEROXIDE  | > 35 – 52                      |                    |                                   | ≥ 45            |           | OP7            |                          |                            |                                |
|   | 1,1-DI-( <i>tert</i> -BUTYLPEROXY)CYCLOHEXANE                 | ≤ 42                           | ≥ 13               |                                   | ≤ 57            |           | OP7            |                          |                            |                                |
|   | DI-( <i>tert</i> -BUTYLPEROXYISOPROPYL)BENZENE(S)             | > 42 – 100                     |                    |                                   | ≥ 45            |           | OP7            |                          |                            | (20)                           |
|   | DI-( <i>tert</i> -BUTYLPEROXY)PHTHALATE                       | ≤ 52 as a paste                |                    |                                   | ≥ 45            |           | OP7            |                          |                            |                                |
|   | 2,2-DI-( <i>tert</i> -BUTYLPEROXY)PROPANE                     | ≤ 42                           | ≥ 13               |                                   | ≥ 58            |           | OP7            |                          |                            | (20)                           |
|   | DI-4-CHLOROBENZOYL PEROXIDE                                   | ≤ 52 as a paste                |                    |                                   |                 |           | OP7            |                          |                            |                                |
|   | 2,2-DI-(4,4-DI-( <i>tert</i> -BUTYLPEROXY)CYCLOHEXYL)-PROPANE | ≤ 42                           |                    |                                   |                 |           | OP7            |                          |                            |                                |
|   | DI-(1-HYDROXYCYCLOHEXYL)PEROXIDE                              | ≤ 100                          |                    |                                   |                 |           | OP7            |                          |                            |                                |
|   | DIISOPROPYLBENZENE DIHYDROPEROXIDE                            | ≤ 82                           | ≥ 5                |                                   | ≥ 5             |           | OP7            |                          |                            | (24)                           |
|   | DILAUROYL PEROXIDE  | ≤ 100                          |                    |                                   |                 |           | OP7            |                          |                            |                                |
|   | DI-(4-METHYLBENZOYL) PEROXIDE                                 | ≤ 52 as paste with silicon oil |                    |                                   |                 |           | OP7            |                          |                            |                                |
|   | 2,5-DIMETHYL-2,5-DI-(BENZOYLPEROXY)HEXANE                     | ≤ 82                           |                    |                                   | ≥ 18            |           | OP7            |                          |                            |                                |
|   | 2,5-DIMETHYL-2,5-DI-( <i>tert</i> -BUTYLPEROXY)-HEXYNE-3      | ≤ 52                           |                    |                                   | ≥ 48            |           | OP7            |                          |                            |                                |
| DI-(2-PHENOXYETHYL)PEROXYDICARBONATE  | ≤ 85  |                                |                    |                                   |                 | OP7       |                |                          |                            |                                |
| ETHYL 3,3-DI-( <i>tert</i> -BUTYLPEROXY)BUTYRATE  | ≤ 52  |                                |                    | ≥ 48                              |                 | OP7       |                |                          |                            |                                |
| ( $\beta$ R-(3R,5aS,6S,8aS,9R,10R,12S,12aR**))-DECAHYDRO-10-METHOXY-3,6,9-TRIMETHYL-3,12-EPOXY-12H-PYRANO[4,3- <i>ij</i> ]-1,2-BENZODIOXEPIN) | ≤ 100   |                                |                    |                                   |                 | OP7       |                |                          |                            |                                |
| 3107  | ACETYL ACETONE PEROXIDE                                       | ≤ 35                           | ≥ 57               |                                   |                 | ≥ 8       | OP8            |                          |                            | (32)                           |
|   | <i>tert</i> -AMYL HYDROPEROXIDE                               | ≤ 88                           | ≥ 6                |                                   |                 | ≥ 6       | OP8            |                          |                            |                                |
|   | <i>tert</i> -BUTYL HYDROPEROXIDE                              | ≤ 79                           |                    |                                   |                 | > 14      | OP8            |                          |                            | (13) (23)                      |
|   | CUMYL HYDROPEROXIDE   | > 90 – 98                      | ≤ 10               |                                   |                 |           | OP8            |                          |                            | (13)                           |
|   | DI- <i>tert</i> -AMYL PEROXIDE                                | ≤ 100                          |                    |                                   |                 |           | OP8            |                          |                            |                                |
|   | DIBENZOYL PEROXIDE  | > 36 – 42                      | ≥ 18               |                                   |                 | ≤ 40      | OP8            |                          |                            |                                |
|   | DI- <i>tert</i> -BUTYL PEROXIDE                               | > 52 – 100                     |                    |                                   |                 |           | OP8            |                          |                            |                                |
|   | 1,1-DI-( <i>tert</i> -BUTYLPEROXY)CYCLOHEXANE                 | ≤ 27                           | ≥ 25               |                                   |                 |           | OP8            |                          |                            | (21)                           |
|   | DI-( <i>tert</i> -BUTYLPEROXY)PHTHALATE                       | ≤ 42                           | ≥ 58               |                                   |                 |           | OP8            |                          |                            |                                |
|   | 1,1-DI-( <i>tert</i> -BUTYLPEROXY)-3,3,5-TRIMETHYLCYCLOHEXANE | ≤ 57                           | ≥ 43               |                                   |                 |           | OP8            |                          |                            |                                |
|   | 1,1-DI-( <i>tert</i> -BUTYLPEROXY)-3,3,5-TRIMETHYLCYCLOHEXANE | ≤ 32                           | ≥ 26               | ≥ 42                              |                 |           | OP8            |                          |                            |                                |

Part 2 – Classification

| Number (generic entry)                | ORGANIC PEROXIDE  | Concentration (%)                    | Diluent type A (%) | Diluent type B (%) <sup>(1)</sup> | Inert solid (%) | Water (%) | Packing method | Control temperature (°C) | Emergency temperature (°C) | Subsidiary hazards and remarks |
|---------------------------------------|---|--------------------------------------|--------------------|-----------------------------------|-----------------|-----------|----------------|--------------------------|----------------------------|--------------------------------|
| 3107<br>(cont.)                       | 2,2-DI-(4,4-DI-( <i>tert</i> -BUTYLPEROXY)CYCLOHEXYL)-PROPANE | ≤ 22                                 |                    | ≥ 78                              |                 |           | OP8            |                          |                            |                                |
|                                       | METHYL ETHYL KETONE PEROXIDE(S)                               | see remark (10)                      | ≥ 60               |                                   |                 |           | OP8            |                          |                            | (10)                           |
|                                       | 3,3,5,7,7-PENTAMETHYL-1,2,4-TRIOXEPANE                        | ≤ 100                                |                    |                                   |                 |           | OP8            |                          |                            |                                |
|                                       | PEROXYACETIC ACID, TYPE E, stabilized                         | ≤ 43                                 |                    |                                   |                 |           | OP8            |                          |                            | (13) (15) (19)                 |
|                                       | POLYETHER POLY- <i>tert</i> -BUTYLPEROXY-CARBONATE            | ≤ 52                                 |                    | ≥ 48                              |                 |           | OP8            |                          |                            |                                |
| 3108                                  | <i>tert</i> -BUTYL CUMYL PEROXIDE                             | ≤ 52                                 |                    |                                   | ≥ 48            |           | OP8            |                          |                            |                                |
|                                       | <i>n</i> -BUTYL 4,4-DI-( <i>tert</i> -BUTYLPEROXY)VALERATE    | ≤ 52                                 |                    |                                   | ≥ 48            |           | OP8            |                          |                            |                                |
|                                       | <i>tert</i> -BUTYL MONOPEROXYMALEATE                          | ≤ 52                                 |                    |                                   | ≥ 48            |           | OP8            |                          |                            |                                |
|                                       | <i>tert</i> -BUTYL MONOPEROXYMALEATE                          | ≤ 52 as a paste                      |                    |                                   |                 |           | OP8            |                          |                            |                                |
|                                       | 1-(2- <i>tert</i> -BUTYLPEROXYISOPROPYL)-3-ISOPROPENYLBENZENE | ≤ 42                                 |                    |                                   |                 | ≥ 58      |                | OP8                      |                            |                                |
|                                       | DIBENZOYL PEROXIDE  | ≤ 56.5 as a paste                    |                    |                                   |                 |           | OP8            |                          |                            |                                |
|                                       | DIBENZOYL PEROXIDE  | ≤ 52 as a paste                      |                    |                                   |                 |           | OP8            |                          |                            | (20)                           |
|                                       | 2,5-DIMETHYL-2,5-DI-( <i>tert</i> -BUTYLPEROXY)HEXANE         | ≤ 47 as a paste                      |                    |                                   |                 |           | OP8            |                          |                            |                                |
|                                       | 2,5-DIMETHYL-2,5-DI-( <i>tert</i> -BUTYLPEROXY)HEXANE         | ≤ 77                                 |                    |                                   |                 | ≥ 23      |                | OP8                      |                            |                                |
|                                       | <i>tert</i> -BUTYL CUMYL PEROXIDE                             | > 42 – 100                           |                    |                                   |                 |           |                | OP8                      |                            |                                |
|                                       | <i>tert</i> -BUTYL HYDROPEROXIDE                              | ≤ 72                                 |                    |                                   |                 |           |                | OP8                      |                            |                                |
|                                       | <i>tert</i> -BUTYL PEROXYACETATE                              | ≤ 32                                 |                    |                                   | ≥ 68            |           | ≥ 28           | OP8                      |                            |                                |
| 3109                                  | <i>tert</i> -BUTYL PEROXY-3,5,5-TRIMETHYL-HEXANOATE           | ≤ 37                                 |                    | ≥ 63                              |                 |           | OP8            |                          |                            |                                |
|                                       | CUMYL HYDROPEROXIDE   | ≤ 90                                 | ≥ 10               |                                   |                 |           | OP8            |                          |                            | (13) (18)                      |
|                                       | DIBENZOYL PEROXIDE  | ≤ 42                                 | ≥ 38               |                                   |                 |           | OP8            |                          |                            |                                |
|                                       | DIBENZOYL PEROXIDE  | ≤ 42 as a stable dispersion in water |                    |                                   |                 |           | OP8            |                          |                            |                                |
|                                       | DI- <i>tert</i> -BUTYL PEROXIDE                               | ≤ 52                                 |                    | ≥ 48                              |                 |           | OP8            |                          |                            | (25)                           |
|                                       | 1,1-DI-( <i>tert</i> -BUTYLPEROXY)CYCLOHEXANE                 | ≤ 42                                 | ≥ 58               |                                   |                 |           | OP8            |                          |                            |                                |
|                                       | 1,1-DI-( <i>tert</i> -BUTYLPEROXY)CYCLOHEXANE                 | ≤ 13                                 | ≥ 13               | ≥ 74                              |                 |           | OP8            |                          |                            |                                |
|                                       | DILAULOYL PEROXIDE  | ≤ 42 as a stable dispersion in water |                    |                                   |                 |           | OP8            |                          |                            |                                |
|                                       | 2,5-DIMETHYL-2,5-DI-( <i>tert</i> -BUTYLPEROXY)HEXANE         | ≤ 52                                 | ≥ 48               |                                   |                 |           | OP8            |                          |                            |                                |
|                                       | ISOPROPYLCUMYL HYDROPEROXIDE                                  | ≤ 72                                 | ≥ 28               |                                   |                 |           | OP8            |                          |                            | (13)                           |
| <i>p</i> -MENTHYL HYDROPEROXIDE       | ≤ 72  | ≥ 28                                 |                    |                                   |                 | OP8       |                |                          | (27)                       |                                |
| METHYL ISOPROPYL KETONE PEROXIDE(S)   | See remark (31)   | ≥ 70                                 |                    |                                   |                 | OP8       |                |                          | (31)                       |                                |
| PEROXYACETIC ACID, TYPE F, stabilized | ≤ 43  |                                      |                    |                                   |                 | OP8       |                |                          | (13) (16) (19)             |                                |

Chapter 2.5 – Class 5 – Oxidizing substances and organic peroxides

| Number (generic entry)             | ORGANIC PEROXIDE   | Concentration (%)        | Diluent type A (%) | Diluent type B (%) <sup>(1)</sup> | Inert solid (%) | Water (%) | Packing method | Control temperature (°C) | Emergency temperature (°C) | Subsidiary hazards and remarks |
|------------------------------------|--|--------------------------|--------------------|-----------------------------------|-----------------|-----------|----------------|--------------------------|----------------------------|--------------------------------|
| 3109 (cont.)                       | 1-PHENYLETHYL HYDROPEROXIDE  | ≤ 38                     |                    | ≥ 62                              |                 |           | OP8            |                          |                            |                                |
|                                    | PINANYL HYDROPEROXIDE  | ≤ 56                     | ≥ 44               |                                   |                 |           | OP8            |                          |                            |                                |
| 3110                               | DICUMYL PEROXIDE   | > 52 – 100               |                    |                                   |                 |           | OP8            |                          |                            | (12)                           |
|                                    | 1,1-DI-( <i>tert</i> -BUTYLPEROXY)-3,3,5-TRIMETHYLCYCLOHEXANE  | ≤ 57                     |                    |                                   | ≥ 43            |           | OP8            |                          |                            |                                |
| 3111                               | 3,6,9-TRIETHYL-3,6,9-TRIMETHYL-1,4,7-TRIPEROXONANE   | ≤ 17                     | ≥ 18               |                                   | ≥ 65            |           | OP8            |                          |                            |                                |
|                                    | <i>tert</i> -BUTYL PEROXYISOBUTYRATE   | > 52 – 77                |                    | ≥ 23                              |                 |           | OP5            | +15                      | +20                        | (3)                            |
| 3112                               | DIISOBUTYRYL PEROXIDE  | > 32 – 52                |                    | ≥ 48                              |                 |           | OP5            | -20                      | -10                        | (3)                            |
|                                    | ISOPROPYL- <i>sec</i> -BUTYL PEROXYDICARBONATE + DI- <i>sec</i> -BUTYL PEROXYDICARBONATE + DIISOPROPYL PEROXYDICARBONATE | ≤ 52 +<br>≤ 28 +<br>≤ 22 |                    |                                   |                 |           | OP5            | -20                      | -10                        | (3)                            |
|                                    | ACETYL CYCLOHEXANESULPHONYL PEROXIDE   | ≤ 82                     |                    |                                   |                 | ≥ 12      | OP4            | -10                      | 0                          | (3)                            |
|                                    | DICYCLOHEXYL PEROXYDICARBONATE   | > 91 – 100               |                    |                                   |                 |           | OP3            | +10                      | +15                        | (3)                            |
| 3113                               | DIISOPROPYL PEROXYDICARBONATE  | > 52 – 100               |                    |                                   |                 |           | OP2            | -15                      | -5                         | (3)                            |
|                                    | DI-(2-METHYLBENZOYL) PEROXIDE  | ≤ 87                     |                    |                                   |                 | ≥ 13      | OP5            | +30                      | +35                        | (3)                            |
|                                    | <i>tert</i> -AMYL PEROXYPIVALATE   | ≤ 77                     |                    | ≥ 23                              |                 |           | OP5            | +10                      | +15                        |                                |
|                                    | <i>tert</i> -BUTYL PEROXYDIETHYLACETATE  | ≤ 100                    |                    |                                   |                 |           | OP5            | +20                      | +25                        |                                |
|                                    | <i>tert</i> -BUTYL PEROXY-2-ETHYLHEXANOATE   | > 52 – 100               |                    |                                   |                 |           | OP6            | +20                      | +25                        |                                |
|                                    | <i>tert</i> -BUTYL PEROXYPIVALATE  | > 67 – 77                |                    | ≥ 23                              |                 |           | OP5            | 0                        | +10                        |                                |
|                                    | DI- <i>sec</i> -BUTYL PEROXYDICARBONATE  | > 52 – 100               |                    |                                   |                 |           | OP4            | -20                      | -10                        |                                |
| DI-(2-ETHYLHEXYL)PEROXYDICARBONATE | > 77 – 100   |                          |                    |                                   |                 | OP5       | -20            | -10                      |                            |                                |
| 3114                               | 2,5-DIMETHYL-2,5-DI-(2-ETHYLHEXANOYLPEROXY)-HEXANE   | ≤ 100                    |                    |                                   |                 |           | OP5            | +20                      | +25                        |                                |
|                                    | DI- <i>n</i> -PROPYL PEROXYDICARBONATE   | ≤ 100                    |                    |                                   |                 |           | OP3            | -25                      | -15                        |                                |
|                                    | DI- <i>n</i> -PROPYL PEROXYDICARBONATE   | ≤ 77                     |                    | ≥ 23                              |                 |           | OP5            | -20                      | -10                        |                                |
|                                    | ORGANIC PEROXIDE, LIQUID, SAMPLE, TEMPERATURE CONTROLLED   |                          |                    |                                   |                 |           | OP2            |                          |                            | (11)                           |
|                                    | DI-(4- <i>tert</i> -BUTYLCYCLOHEXYL)-PEROXYDICARBONATE   | ≤ 100                    |                    |                                   |                 |           | OP6            | +30                      | +35                        |                                |
| 3114                               | DICYCLOHEXYL PEROXYDICARBONATE   | ≤ 91                     |                    |                                   |                 | ≥ 9       | OP5            | +10                      | +15                        |                                |
|                                    | DIDECANOYL PEROXIDE  | ≤ 100                    |                    |                                   |                 |           | OP6            | +30                      | +35                        |                                |
|                                    | DI- <i>n</i> -OCTANOYL PEROXIDE  | ≤ 100                    |                    |                                   |                 |           | OP5            | +10                      | +15                        |                                |
|                                    | ORGANIC PEROXIDE, SOLID, SAMPLE, TEMPERATURE CONTROLLED  |                          |                    |                                   |                 |           | OP2            |                          |                            | (11)                           |

Part 2 – Classification

2

| Number (generic entry)  | ORGANIC PEROXIDE  | Concentration (%) | Diluent type A (%) | Diluent type B (%) <sup>(1)</sup> | Inert solid (%) | Water (%) | Packing method | Control temperature (°C) | Emergency temperature (°C) | Subsidiary hazards and remarks |
|---|---|-------------------|--------------------|-----------------------------------|-----------------|-----------|----------------|--------------------------|----------------------------|--------------------------------|
| 3115  | ACETYL CYCLOHEXANESULPHONYL PEROXIDE  | ≤ 32              |                    | ≥ 68                              |                 |           | OP7            | -10                      | 0                          |                                |
|   | <i>tert</i> -AMYL PEROXY-2-ETHYLHEXANOATE   | ≤ 100             |                    |                                   |                 |           | OP7            | +20                      | +25                        |                                |
|   | <i>tert</i> -AMYL PEROXYNEODECANOATE  | ≤ 77              |                    | ≥ 23                              |                 |           | OP7            | 0                        | +10                        |                                |
|   | <i>tert</i> -BUTYL PEROXY-2-ETHYLHEXANOATE + 2,2-DI-( <i>tert</i> -BUTYLPEROXY)BUTANE | ≤ 31 + ≤ 36       |                    | ≥ 33                              |                 |           | OP7            | +35                      | +40                        |                                |
|   | <i>tert</i> -BUTYL PEROXYISOBUTYRATE  | ≤ 52              |                    | ≥ 48                              |                 |           | OP7            | +15                      | +20                        |                                |
|   | <i>tert</i> -BUTYL PEROXYNEODECANOATE   | > 77 – 100        |                    |                                   |                 |           | OP7            | -5                       | +5                         |                                |
|   | <i>tert</i> -BUTYL PEROXYNEODECANOATE   | ≤ 77              |                    | ≥ 23                              |                 |           | OP7            | 0                        | +10                        |                                |
|   | <i>tert</i> -BUTYL PEROXYNEOHEPTANOATE  | ≤ 77              | ≥ 23               |                                   |                 |           | OP7            | 0                        | +10                        |                                |
|   | <i>tert</i> -BUTYL PEROXYPIVALATE   | > 27 – 67         |                    | ≥ 33                              |                 |           | OP7            | 0                        | +10                        |                                |
|   | CUMYL PEROXYNEODECANOATE  | ≤ 77              |                    | ≥ 23                              |                 |           | OP7            | -10                      | 0                          |                                |
|   | CUMYL PEROXYNEODECANOATE  | ≤ 87              | ≥ 13               |                                   |                 |           | OP7            | -10                      | 0                          |                                |
|   | CUMYL PEROXYNEOHEPTANOATE   | ≤ 77              | ≥ 23               |                                   |                 |           | OP7            | -10                      | 0                          |                                |
|   | CUMYL PEROXYPIVALATE  | ≤ 77              |                    | ≥ 23                              |                 |           | OP7            | -5                       | +5                         |                                |
|   | DIACETONE ALCOHOL PEROXIDES   | ≤ 57              |                    | ≥ 26                              |                 | ≥ 8       | OP7            | +40                      | +45                        | (6)                            |
|   | DIACETYL PEROXIDE   | ≤ 27              |                    | ≥ 73                              |                 |           | OP7            | +20                      | +25                        | (7) (13)                       |
|   | DI- <i>n</i> -BUTYL PEROXYDICARBONATE   | > 27 – 52         |                    | ≥ 48                              |                 |           | OP7            | -15                      | -5                         |                                |
|   | DI- <i>sec</i> -BUTYL PEROXYDICARBONATE   | ≤ 52              |                    | ≥ 48                              |                 |           | OP7            | -15                      | -5                         |                                |
|   | DI-(2-ETHOXYETHYL)PEROXYDICARBONATE   | ≤ 52              |                    | ≥ 48                              |                 |           | OP7            | -10                      | 0                          |                                |
|   | DI-(2-ETHYLHEXYL)PEROXYDICARBONATE  | ≤ 77              |                    | ≥ 23                              |                 |           | OP7            | -15                      | -5                         |                                |
|   | DIISOBUTYRYL PEROXIDE   | ≤ 32              |                    | ≥ 68                              |                 |           | OP7            | -20                      | -10                        |                                |
| DIISOPROPYL PEROXYDICARBONATE   | ≤ 52  |                   | ≥ 48               |                                   |                 | OP7       | -20            | -10                      |                            |                                |
| DIISOPROPYL PEROXYDICARBONATE   | ≤ 32  | ≥ 68              |                    |                                   |                 | OP7       | -15            | -5                       |                            |                                |
| DI-(3-METHOXYBUTYL) PEROXYDICARBONATE   | ≤ 52  |                   | ≥ 48               |                                   |                 | OP7       | -5             | +5                       |                            |                                |
| DI-(3-METHYLBENZOYL) PEROXIDE + BENZOYL (3-METHYLBENZOYL) PEROXIDE + DIBENZOYL PEROXIDE | ≤ 20 + ≤ 18 + ≤ 4   |                   | ≥ 58               |                                   |                 | OP7       | +35            | +40                      |                            |                                |
| DI-(2-NEODECANOYL)PEROXYISOPROPYL)-BENZENE  | ≤ 52  | ≥ 48              |                    |                                   |                 | OP7       | -10            | 0                        |                            |                                |
| DI-(3,5,5-TRIMETHYLHEXANOYL) PEROXIDE   | > 52 – 82   | ≥ 18              |                    |                                   |                 | OP7       | 0              | +10                      |                            |                                |
| 1-(2-ETHYLHEXANOYL)PEROXY)-1,3-DIMETHYLBUTYL PEROXYPIVALATE                             | ≤ 52  | ≥ 45              |                    | ≥ 10                              |                 | OP7       | -20            | -10                      |                            |                                |
| <i>tert</i> -HEXYL PEROXYNEODECANOATE   | ≤ 71  | ≥ 29              |                    |                                   |                 | OP7       | 0              | +10                      |                            |                                |
| <i>tert</i> -HEXYL PEROXYPIVALATE   | ≤ 72  |                   | ≥ 28               |                                   |                 | OP7       | +10            | +15                      |                            |                                |

Chapter 2.5 – Class 5 – Oxidizing substances and organic peroxides

| Number (generic entry) | ORGANIC PEROXIDE   | Concentration (%)                             | Diluent type A (%) | Diluent type B (%) <sup>(1)</sup> | Inert solid (%) | Water (%) | Packing method | Control temperature (°C) | Emergency temperature (°C) | Subsidiary hazards and remarks |
|------------------------|--|---|--------------------|-----------------------------------|-----------------|-----------|----------------|--------------------------|----------------------------|--------------------------------|
| 3115<br>(cont.)        | 3-HYDROXY-1,1-DIMETHYLBUTYL PEROXYNEODECANOATE   | ≤ 77  | ≥ 23               |                                   |                 |           | OP7            | -5                       | +5                         |                                |
|                        | ISOPROPYL <i>sec</i> -BUTYL PEROXYDICARBONATE + DI- <i>sec</i> -BUTYL PEROXYDICARBONATE + DI-ISOPROPYL PEROXYDICARBONATE | ≤ 32 +<br>≤ 15 - 18 +<br>≤ 12 - 15            | ≥ 38               |                                   |                 |           | OP7            | -20                      | -10                        |                                |
|                        | METHYLCYCLOHEXANONE PEROXIDE(S)  | ≤ 67  |                    | ≥ 33                              |                 |           | OP7            | +35                      | +40                        |                                |
|                        | 1,1,3,3-TETRAMETHYLBUTYL PEROXY-2-ETHYLHEXANOATE   | ≤ 100   |                    |                                   |                 |           | OP7            | +15                      | +20                        |                                |
|                        | 1,1,3,3-TETRAMETHYLBUTYL PEROXY-NEODECANOATE   | ≤ 72  |                    | ≥ 28                              |                 |           | OP7            | -5                       | +5                         |                                |
|                        | 1,1,3,3-TETRAMETHYLBUTYL PEROXYPIVALATE  | ≤ 77  | ≥ 23               |                                   |                 |           | OP7            | 0                        | +10                        |                                |
|                        |  |   |                    |                                   |                 |           |                |                          |                            |                                |
| 3116                   | DIMYRISTYL PEROXYDICARBONATE   | ≤ 100   |                    |                                   |                 |           | OP7            | +20                      | +25                        |                                |
|                        | DI- <i>n</i> -NONANOYL PEROXIDE  | ≤ 100   |                    |                                   |                 |           | OP7            | 0                        | +10                        |                                |
|                        | DISUCCINIC ACID PEROXIDE   | ≤ 72  |                    |                                   |                 | ≥ 28      | OP7            | +10                      | +15                        |                                |
|                        | <i>tert</i> -BUTYL PEROXY-2-ETHYLHEXANOATE   | > 32 - 52                                     |                    | ≥ 48                              |                 |           | OP8            | +30                      | +35                        |                                |
| 3117                   | DI- <i>n</i> -BUTYL PEROXYDICARBONATE  | ≤ 27  |                    | ≥ 73                              |                 |           | OP8            | -10                      | 0                          |                                |
|                        | <i>tert</i> -BUTYL PEROXYNEOHEPTANOATE   | ≤ 42 as a stable dispersion in water          |                    |                                   |                 |           | OP8            | 0                        | +10                        |                                |
|                        | 1,1-DIMETHYL-3-HYDROXYBUTYL PEROXY-NEOHEPTANOATE   | ≤ 52  | ≥ 48               |                                   |                 |           | OP8            | 0                        | +10                        |                                |
|                        | DIPROPIONYL PEROXIDE   | ≤ 27  |                    | ≥ 73                              |                 |           | OP8            | +15                      | +20                        |                                |
|                        | <i>tert</i> -HEXYL PEROXYPIVALATE  | ≤ 52 as a stable dispersion in water          |                    |                                   |                 |           | OP8            | +15                      | +20                        |                                |
|                        | 3-HYDROXY-1,1-DIMETHYLBUTYL PEROXY-NEODECANOATE  | ≤ 52  | ≥ 48               |                                   |                 |           | OP8            | -5                       | +5                         |                                |
| 3118                   | <i>tert</i> -BUTYL PEROXY-2-ETHYLHEXANOATE   | ≤ 52  |                    |                                   | ≥ 48            |           | OP8            | +20                      | +25                        |                                |
|                        | <i>tert</i> -BUTYL PEROXYNEODECANOATE  | ≤ 42 as a stable dispersion in water (frozen) |                    |                                   |                 |           | OP8            | 0                        | +10                        |                                |
|                        | DI-(4- <i>tert</i> -BUTYLCYCLOHEXYL) PEROXYDICARBONATE   | ≤ 42 as a paste                               |                    |                                   |                 |           | OP8            | +35                      | +40                        |                                |
|                        | DI- <i>n</i> -BUTYL PEROXYDICARBONATE  | ≤ 42 as a stable dispersion in water (frozen) |                    |                                   |                 |           | OP8            | -15                      | -5                         |                                |
|                        | DI-2,4-DICHLOROBENZOYL PEROXIDE  | ≤ 52 as a paste                               |                    |                                   |                 |           | OP8            | +20                      | +25                        |                                |
|                        | PEROXYLAURIC ACID  | ≤ 100   |                    |                                   |                 |           | OP8            | +35                      | +40                        |                                |

Part 2 – Classification

2

| Number (generic entry)                         | ORGANIC PEROXIDE                                       | Concentration (%)                             | Diluent type A (%) | Diluent type B (%) <sup>(1)</sup> | Inert solid (%) | Water (%) | Packing method | Control temperature (°C) | Emergency temperature (°C) | Subsidiary hazards and remarks |
|--|--|---|--------------------|-----------------------------------|-----------------|-----------|----------------|--------------------------|----------------------------|--------------------------------|
| 3119   | <i>tert</i> -AMYL PEROXYNEODECANOATE                   | ≤ 47  | ≥ 53               |                                   |                 |           | OP8            | 0                        | +10                        |                                |
|  | <i>tert</i> -BUTYL PEROXY-2-ETHYLHEXANOATE             | ≤ 32  |                    | ≥ 68                              |                 |           | OP8            | +40                      | +45                        |                                |
|  | <i>tert</i> -BUTYL PEROXYNEODECANOATE                  | ≤ 52 as a stable dispersion in water          |                    |                                   |                 |           | OP8            | 0                        | +10                        |                                |
|  | <i>tert</i> -BUTYL PEROXYNEODECANOATE                  | ≤ 32  | ≥ 68               |                                   |                 |           | OP8            | 0                        | +10                        |                                |
|  | <i>tert</i> -BUTYL PEROXYPIVALATE                      | ≤ 27  |                    | ≥ 73                              |                 |           | OP8            | +30                      | +35                        |                                |
|  | CUMYL PEROXYNEODECANOATE                               | ≤ 52 as a stable dispersion in water          |                    |                                   |                 |           | OP8            | -10                      | 0                          |                                |
|  | DI-(4- <i>tert</i> -BUTYL)CYCLOHEXYL PEROXYDICARBONATE | ≤ 42 as a stable dispersion in water          |                    |                                   |                 |           | OP8            | +30                      | +35                        |                                |
|  | DICETYL PEROXYDICARBONATE                              | ≤ 42 as a stable dispersion in water          |                    |                                   |                 |           | OP8            | +30                      | +35                        |                                |
|  | DICYCLOHEXYL PEROXYDICARBONATE                         | ≤ 42 as a stable dispersion in water          |                    |                                   |                 |           | OP8            | +15                      | +20                        |                                |
|  | DI-(2-ETHYLHEXYL) PEROXYDICARBONATE                    | ≤ 62 as a stable dispersion in water          |                    |                                   |                 |           | OP8            | -15                      | -5                         |                                |
|  | DIISOBUTYRYL PEROXIDE                                  | ≤ 42 as a stable dispersion in water          |                    |                                   |                 |           | OP8            | -20                      | -10                        |                                |
|  | DIMYRISTYL PEROXYDICARBONATE                           | ≤ 42 as a stable dispersion in water          |                    |                                   |                 |           | OP8            | +20                      | +25                        |                                |
|  | DI-(3,5,5-TRIMETHYLHEXANOYL) PEROXIDE                  | ≤ 52 as a stable dispersion in water          |                    |                                   |                 |           | OP8            | +10                      | +15                        |                                |
|  | DI-(3,5,5-TRIMETHYLHEXANOYL) PEROXIDE                  | ≤ 38  | ≥ 62               |                                   |                 |           | OP8            | +20                      | +25                        |                                |
| DI-(3,5,5-TRIMETHYLHEXANOYL) PEROXIDE          | > 38 – 52  | ≥ 48  |                    |                                   |                 | OP8       | +10            | +15                      |                            |                                |
| 3-HYDROXY-1,1-DIMETHYLBUTYL PEROXYNEODECANOATE | ≤ 52 as a stable dispersion in water                   |   |                    |                                   |                 | OP 8      | -5             | +5                       |                            |                                |
| 1,1,3,3-TETRAMETHYLBUTYL PEROXYNEODECANOATE    | ≤ 52 as a stable dispersion in water                   |   |                    |                                   |                 | OP8       | -5             | +5                       |                            |                                |
| 3120   | DI-(2-ETHYLHEXYL)PEROXYDICARBONATE                     | ≤ 52 as a stable dispersion in water (frozen) |                    |                                   |                 |           | OP8            | -15                      | -5                         |                                |
|  | DICETYL PEROXYDICARBONATE                              | ≤ 100   |                    |                                   |                 |           | OP8            | +30                      | +35                        |                                |
| Exempt   | CYCLOHEXANONE PEROXIDE(S)                              | ≤ 32  |                    |                                   | ≥ 68            |           |                |                          |                            | (29)                           |
| Exempt   | DIBENZOYL PEROXIDE                                     | ≤ 35  |                    |                                   | ≥ 65            |           |                |                          |                            | (29)                           |
| Exempt   | DI-( <i>tert</i> -BUTYLPEROXYISOPROPYL)BENZENE(S)      | ≤ 42  |                    |                                   | ≥ 58            |           |                |                          |                            | (29)                           |
| Exempt   | DI-4-CHLOROBENZOYL PEROXIDE                            | ≤ 32  |                    |                                   | ≥ 68            |           |                |                          |                            | (29)                           |
| Exempt   | DICUMYL PEROXIDE                                       | ≤ 52  |                    |                                   | ≥ 48            |           |                |                          |                            | (29)                           |
| Exempt   | 2,5-DIMETHYL-2,5-DI-( <i>tert</i> -BUTYLPEROXY) HEXANE | ≤ 22  |                    |                                   | ≥ 78            |           |                |                          |                            | (29)                           |

## Remarks

- (1) Diluent type B may always be replaced by diluent type A. The boiling point of diluent type B shall be at least 60°C higher than the SADT of the organic peroxide
- (2) Available oxygen  $\leq$  4.7%
- (3) "EXPLOSIVE" subsidiary hazard label required. (Model No. 1, see 5.2.2.2.2)
- (4) Diluent may be replaced by di-*tert*-butyl peroxide
- (5) Available oxygen  $\leq$  9%
- (6) With  $\leq$  9% hydrogen peroxide; available oxygen  $\leq$  10%
- (7) Only non-metallic packagings are allowed
- (8) Available oxygen  $>$  10% and  $\leq$  10.7%, with or without water
- (9) Available oxygen  $\leq$  10%, with or without water
- (10) Available oxygen  $\leq$  8.2%, with or without water
- (11) See 2.5.3.2.5.1
- (12) Up to 2,000 kg per receptacle assigned to ORGANIC PEROXIDE TYPE F on the basis of large-scale trials
- (13) "CORROSIVE" subsidiary hazard label required (Model No. 8, see 5.2.2.2.2)
- (14) Peroxyacetic acid formulations which fulfil the criteria of 2.5.3.3.2.4
- (15) Peroxyacetic acid formulations which fulfil the criteria of 2.5.3.3.2.5
- (16) Peroxyacetic acid formulations which fulfil the criteria of 2.5.3.3.2.6
- (17) Addition of water to this organic peroxide will decrease its thermal stability
- (18) No "CORROSIVE" subsidiary hazard label required for concentrations below 80%
- (19) Mixtures with hydrogen peroxide, water and acid(s)
- (20) With diluent type A, with or without water
- (21) With  $\geq$  25% diluent type A by mass, and in addition ethylbenzene
- (22) With  $\geq$  19% diluent type A by mass, and in addition methyl isobutyl ketone
- (23) With  $<$  6% di-*tert*-butyl peroxide
- (24) With  $\leq$  8% 1-isopropylhydroperoxy-4-isopropylhydroxybenzene
- (25) Diluent type B with boiling point  $>$  110°C
- (26) With  $<$  0.5% hydroperoxides content
- (27) For concentrations more than 56%, "CORROSIVE" subsidiary hazard label required (Model No. 8, see 5.2.2.2.2)
- (28) Available active oxygen  $\leq$  7.6% in diluent type A having a 95% boil-off point in the range 200–260°C
- (29) Not subject to the provisions for peroxide, class 5.2
- (30) Diluent type B with boiling point  $>$  130°C
- (31) Active oxygen  $\leq$  6.7%
- (32) Active oxygen  $\leq$  4.15%
- (33) Available oxygen  $\leq$  10%
- (34) Sum of diluent type A and water  $\geq$  55%, and in addition methyl ethyl ketone

**2.5.3.2.5** Classification of organic peroxides not listed in 2.5.3.2.4, packing instruction IBC520 or portable tank instruction T23 and assignment to a generic entry shall be made by the competent authority of the country of origin on the basis of a test report. Principles applying to the classification of such substances are provided in 2.5.3.3. Test methods and criteria and an example of a report are given in the current edition of the *Manual of Tests and Criteria*, part II. The statement of approval shall contain the classification and the relevant transport conditions (see 5.4.4.1.3).

**2.5.3.2.5.1** Samples of new organic peroxides or new formulations of currently assigned organic peroxides for which complete test data are not available and which are to be transported for further testing or evaluation may be assigned to one of the appropriate entries for ORGANIC PEROXIDE TYPE C provided the following conditions are met:

- .1 the available data indicate that the sample would be no more dangerous than ORGANIC PEROXIDE TYPE B;
- .2 the sample is packaged in accordance with packing method OP2 and the quantity per cargo transport unit is limited to 10 kg; and
- .3 the available data indicate that the control temperature, if any, is sufficiently low to prevent any dangerous decomposition and sufficiently high to prevent any dangerous phase separation.

### 2.5.3.3 Principles for classification of organic peroxides

**Note:** This section refers only to those properties of organic peroxides which are decisive for their classification. A flow chart, presenting the classification principles in the form of a graphically arranged scheme of questions concerning the decisive properties together with the possible answers, is given in figure 2.5.1 in chapter 2.5 of the United Nations *Recommendations on the Transport of Dangerous Goods*. These properties shall be determined experimentally. Suitable test methods with pertinent evaluation criteria are given in the *Manual of Tests and Criteria*, part II.



## Part 2 – Classification

- 2.5.3.3.1 Any organic peroxide formulation shall be regarded as possessing explosive properties when, in laboratory testing, the formulation is liable to detonate, to deflagrate rapidly or to show a violent effect when heated under confinement.
- 2.5.3.3.2 The following principles apply to the classification of organic peroxide formulations not listed in 2.5.3.2.4:
- .1 Any organic peroxide formulation which can detonate or deflagrate rapidly, as packaged for transport, is prohibited from transport in that packaging under class 5.2 (defined as ORGANIC PEROXIDE TYPE A);
  - .2 Any organic peroxide formulation possessing explosive properties and which, as packaged for transport, neither detonates nor deflagrates rapidly, but is liable to undergo a thermal explosion in that package, shall bear an “EXPLOSIVE” subsidiary hazard label (Model No. 1, see 5.2.2.2.2). Such an organic peroxide may be packaged in amounts of up to 25 kg unless the maximum quantity has to be limited to a lower amount to preclude detonation or rapid deflagration in the package (defined as ORGANIC PEROXIDE TYPE B);
  - .3 Any organic peroxide formulation possessing explosive properties may be transported without an “EXPLOSIVE” subsidiary hazard label when the substance as packaged (maximum 50 kg) for transport cannot detonate or deflagrate rapidly or undergo a thermal explosion (defined as ORGANIC PEROXIDE TYPE C);
  - .4 Any organic peroxide formulation which, in laboratory testing:
    - .1 detonates partially, does not deflagrate rapidly and shows no violent effect when heated under confinement; or
    - .2 does not detonate at all, deflagrates slowly and shows no violent effect when heated under confinement; or
    - .3 does not detonate or deflagrate at all and shows a medium effect when heated under confinement
 is acceptable for transport in packages of not more than 50 kg net mass (defined as ORGANIC PEROXIDE TYPE D);
  - .5 Any organic peroxide formulation which, in laboratory testing, neither detonates nor deflagrates at all and shows low or no effect when heated under confinement is acceptable for transport in packages of not more than 400 kg/450 L (defined as ORGANIC PEROXIDE TYPE E);
  - .6 Any organic peroxide formulation which, in laboratory testing, neither detonates in the cavitated state nor deflagrates at all and shows only a low or no effect when heated under confinement as well as low or no explosive power may be considered for transport in IBCs or tanks (defined as ORGANIC PEROXIDE TYPE F); for additional provisions see 4.1.7 and 4.2.1.13;
  - .7 Any organic peroxide formulation which, in laboratory testing, neither detonates in the cavitated state nor deflagrates at all and shows no effect when heated under confinement nor any explosive power shall be exempted from class 5.2, provided that the formulation is thermally stable (self-accelerating decomposition temperature is 60°C or higher for a 50 kg package) and for liquid formulations diluent type A is used for desensitization (defined as ORGANIC PEROXIDE TYPE G). If the formulation is not thermally stable or a diluent other than type A is used for desensitization, the formulation shall be defined as ORGANIC PEROXIDE TYPE F.
- 2.5.3.4 Temperature control provisions
- 2.5.3.4.0 The properties of some organic peroxides require that they be transported under temperature control. Control and emergency temperatures for currently assigned organic peroxides are shown in the list 2.5.3.2.4. The controlled temperature provisions are given in chapter 7.3.7.
- 2.5.3.4.1 The following organic peroxides shall be subjected to temperature control during transport:
- .1 organic peroxides type B and C with a SADT  $\leq 50^{\circ}\text{C}$ ;
  - .2 organic peroxides type D showing a medium effect when heated under confinement\* with a SADT  $\leq 50^{\circ}\text{C}$  or showing a low or no effect when heated under confinement with a SADT  $\leq 45^{\circ}\text{C}$ ; and
  - .3 organic peroxides types E and F with a SADT  $\leq 45^{\circ}\text{C}$ .
- 2.5.3.4.2 Test methods for determining the SADT are given in the *Manual of Tests and Criteria*, part II, section 28. The test selected shall be conducted in a manner which is representative, both in size and material, of the package to be transported.
- 2.5.3.4.3 Test methods for determining the flammability are given in the *Manual of Tests and Criteria*, part III, subsection 32.4. Because organic peroxides may react vigorously when heated, it is recommended to determine their flashpoint using small sample sizes such as described in ISO 3679.

\* As determined by test series E as prescribed in the *Manual of Tests and Criteria*, part II.

**2.5.3.5 Desensitization of organic peroxides**

- 2.5.3.5.1** In order to ensure safety during transport, organic peroxides are in many cases desensitized by organic liquids or solids, inorganic solids or water. Where a percentage of a substance is stipulated, this refers to the percentage by mass, rounded to the nearest whole number. In general, desensitization shall be such that, in case of spillage or fire, the organic peroxide will not concentrate to a dangerous extent.
- 2.5.3.5.2** Unless otherwise stated for the individual organic peroxide formulation, the following definitions apply for diluents used for desensitization:
- .1** Diluents type A are organic liquids which are compatible with the organic peroxide and which have a boiling point of not less than 150°C. Type A diluents may be used for desensitizing all organic peroxides.
  - .2** Diluents type B are organic liquids which are compatible with the organic peroxide and which have a boiling point of less than 150°C but not less than 60°C and a flashpoint of not less than 5°C. Type B diluents may be used for desensitization of all organic peroxides provided that the boiling point is at least 60°C higher than the SADT in a 50 kg package.
- 2.5.3.5.3** Diluents, other than type A or type B, may be added to organic peroxide formulations as listed in 2.5.3.2.4 provided that they are compatible. However, replacement of all or part of a type A or type B diluent by another diluent with differing properties requires that the organic peroxide formulation be re-assessed in accordance with the normal acceptance procedure for class 5.2.
- 2.5.3.5.4** Water may only be used for the desensitization of organic peroxides which are shown in 2.5.3.2.4 or in the statement of approval according to 2.5.3.2.5 as being with water or as a stable dispersion in water.
- 2.5.3.5.5** Organic and inorganic solids may be used for desensitization of organic peroxides provided that they are compatible.
- 2.5.3.5.6** Compatible liquids and solids are those which have no detrimental influence on the thermal stability and hazard type of the organic peroxide formulation.

## Chapter 2.6

### Class 6 – Toxic and infectious substances

#### 2.6.0 Introductory notes

**Note 1:** The word “toxic” has the same meaning as “poisonous”.

**Note 2:** Genetically modified microorganisms which do not meet the definition of a toxic or an infectious substance shall be considered for classification in class 9 and assigned to UN 3245.

**Note 3:** Toxins from plant, animal or bacterial sources which do not contain any infectious substances, or toxins that are contained in substances which are not infectious substances, shall be considered for classification in class 6.1 and assigned to UN 3172 or UN 3462.

#### 2.6.1 Definitions

Class 6 is subdivided into two classes as follows:

Class 6.1 – Toxic substances

These are substances liable either to cause death or serious injury or to harm human health if swallowed or inhaled, or by skin contact.

Class 6.2 – Infectious substances

These are substances known or reasonably expected to contain pathogens. Pathogens are defined as microorganisms (including bacteria, viruses, parasites, fungi) and other agents such as prions, which can cause disease in humans or animals.

#### 2.6.2 Class 6.1 – Toxic substances

##### 2.6.2.1 Definitions and properties

**2.6.2.1.1** *LD<sub>50</sub> (median lethal dose) for acute oral toxicity* is the statistically derived single dose of a substance that can be expected to cause death within 14 days in 50 per cent of young adult albino rats when administered by the oral route. The *LD<sub>50</sub>* value is expressed in terms of mass of test substance per mass of test animal (mg/kg).

**2.6.2.1.2** *LD<sub>50</sub> for acute dermal toxicity* is that dose of the substance which, administered by continuous contact for 24 hours with the bare skin of the albino rabbit, is most likely to cause death within 14 days in one half of the animals tested. The number of animals tested shall be sufficient to give a statistically significant result and be in conformity with good pharmacological practices. The result is expressed in milligrams per kilogram body mass.

**2.6.2.1.3** *LC<sub>50</sub> for acute toxicity on inhalation* is that concentration of vapour, mist or dust which, administered by continuous inhalation to both male and female young adult albino rats for one hour, is most likely to cause death within 14 days in one half of the animals tested. A solid substance shall be tested if at least 10% (by mass) of its total mass is likely to be dust in the respirable range, such as the aerodynamic diameter of that particle fraction is 10 microns or less. A liquid substance shall be tested if a mist is likely to be generated in a leakage of the transport containment. For both solid and liquid substances, more than 90% (by mass) of a specimen prepared for inhalation toxicity testing shall be in the respirable range as defined above. The result is expressed in milligrams per litre of air for dusts and mists or in millilitres per cubic metre of air (parts per million) for vapours.

##### 2.6.2.1.4 Properties

.1 The dangers of poisoning which are inherent in these substances depend upon contact with the human body, that is by inhalation of vapours by unsuspecting persons at some distance from the cargo or the immediate dangers of physical contact with the substance. These have been considered in the context of the probability of accident occurring during transport by sea.

- .2 Nearly all toxic substances evolve toxic gases when involved in a fire or when heated to decomposition.
- .3 A substance specified as “stabilized” shall not be transported in an unstabilized condition.

### 2.6.2.2 Assignment of packing groups to toxic substances

2.6.2.2.1 Toxic substances have for packing purposes been apportioned among packing groups according to the degree of their toxic hazards in transport:

- .1 Packing group I: substances and preparations presenting a high toxicity hazard;
- .2 Packing group II: substances and preparations presenting a medium toxicity hazard;
- .3 Packing group III: substances and preparations presenting a low toxicity hazard.

2.6.2.2.2 In making this grouping, account has been taken of human experience in instances of accidental poisoning, and of special properties possessed by any individual substance, such as liquid state, high volatility, any special likelihood of penetration, and special biological effects.

2.6.2.2.3 In the absence of human experience, the grouping has been based on data obtained from animal experiments. Three possible routes of administration have been examined. These routes are exposure through:

- oral ingestion;
- dermal contact; and
- inhalation of dusts, mists or vapours.

2.6.2.2.3.1 For appropriate animal test data for the various routes of exposure, see 2.6.2.1. When a substance exhibits a different order of toxicity by two or more routes of administration, the highest degree of danger indicated by the tests has been used in assigning the packing group.

2.6.2.2.4 The criteria to be applied for grouping a substance according to the toxicity it exhibits by all three routes of administration are presented in the following paragraphs.

2.6.2.2.4.1 The grouping criteria for the oral and dermal routes as well as for inhalation of dusts and mists are shown in the following table:

**Grouping criteria for administration through oral ingestion,  
dermal contact and inhalation of dusts and mists**

| Packing group | Oral toxicity<br>LD <sub>50</sub><br>(mg/kg) | Dermal toxicity<br>LD <sub>50</sub><br>(mg/kg) | Inhalation toxicity<br>by dusts and mists<br>LC <sub>50</sub><br>(mg/L) |
|---------------|--|--|---|
| I             | ≤ 5.0  | ≤ 50   | ≤ 0.2   |
| II            | > 5.0 and ≤ 50                               | > 50 and ≤ 200                                 | > 0.2 and ≤ 2.0   |
| III*          | > 50 and ≤ 300                               | > 200 and ≤ 1,000                              | > 2.0 and ≤ 4.0   |

\* Tear gas substances shall be included in packing group II even if their toxicity data correspond to packing group III values.

**Note:** Substances meeting the criteria of class 8 and with an inhalation toxicity of dusts and mists (LC<sub>50</sub>) leading to packing group I are only accepted for an allocation to class 6.1 if the toxicity through oral ingestion or dermal contact is at least in the range of packing group I or II. Otherwise an allocation to class 8 is made when appropriate (see 2.8.2.4).

2.6.2.2.4.2 The criteria for inhalation toxicity of dusts and mists in 2.6.2.2.4.1 are based on LC<sub>50</sub> data relating to one hour exposures, and where such information is available it shall be used. However, where only LC<sub>50</sub> data relating to 4-hour exposures to dusts and mists are available, such figures can be multiplied by four and the product substituted in the above criteria, i.e. LC<sub>50</sub> (4 hours) × 4 is considered the equivalent of LC<sub>50</sub> (1 hour).

2.6.2.2.4.3 Liquids having toxic vapours shall be assigned to the following packing groups, where “V” is the saturated vapour concentration in mL/m<sup>3</sup> air at 20°C and standard atmospheric pressure:

Packing group I: if  $V \geq 10 LC_{50}$  and  $LC_{50} \leq 1,000 \text{ mL/m}^3$ .

Packing group II: if  $V \geq LC_{50}$  and  $LC_{50} \leq 3,000 \text{ mL/m}^3$ , and do not meet the criteria for packing group I.

Packing group III: if  $V \geq \frac{1}{5} LC_{50}$  and  $LC_{50} \leq 5,000 \text{ mL/m}^3$ , and do not meet the criteria for packing groups I or II.

**Note:** Tear gas substances shall be included in packing group II even if their toxicity data correspond to packing group III values.

Part 2 – Classification

2.6.2.2.4.4 In figure 2-3 the criteria according to 2.6.2.2.4.3 are expressed in graphical form, as an aid to easy classification. Because of approximations inherent in the use of graphs, substances falling on or near packing group borderlines shall be checked using numerical criteria.

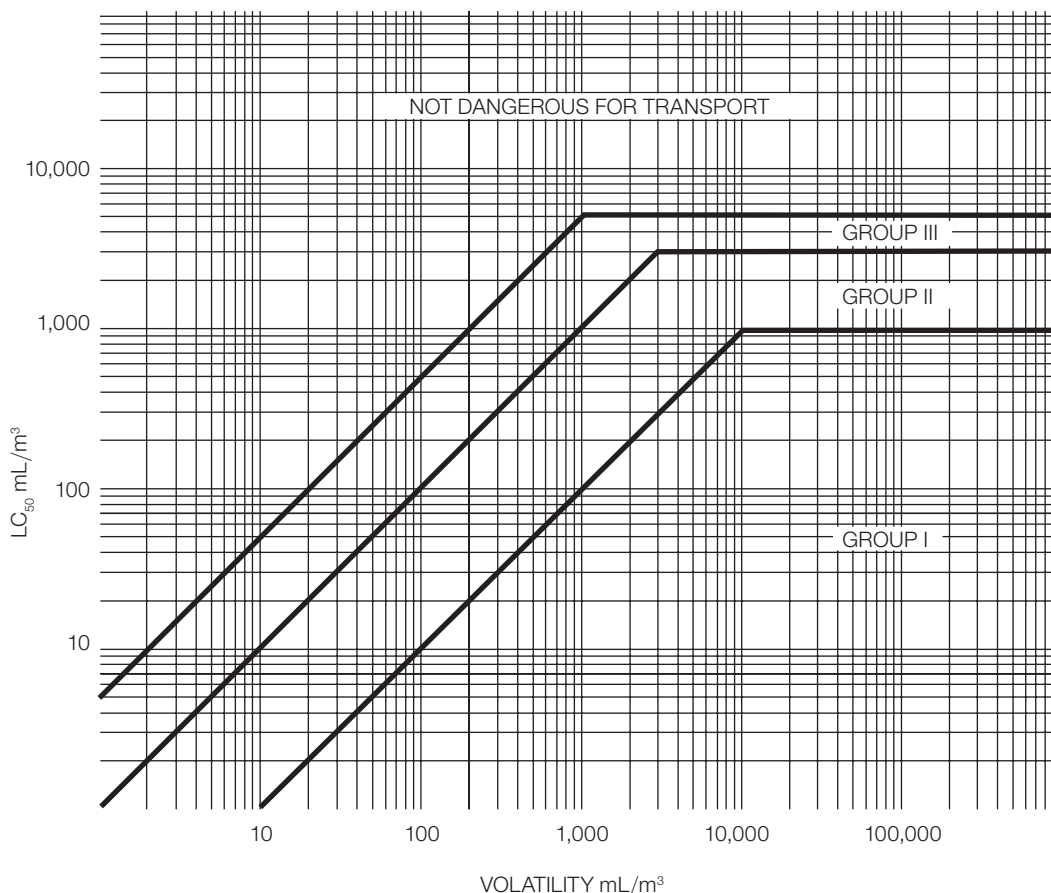

Figure 2-3 – Inhalation toxicity: packing group borderlines

2.6.2.2.4.5 The criteria for inhalation toxicity of vapours in 2.6.2.2.4.3 are based on LC<sub>50</sub> data relating to one hour exposures, and where such information is available it shall be used. However, where only LC<sub>50</sub> data relating to 4-hour exposures to the vapours are available, such figures can be multiplied by two and the product substituted in the above criteria, i.e. LC<sub>50</sub> (4 hours) × 2 is considered the equivalent of LC<sub>50</sub> (1 hour).

2.6.2.2.4.6 Mixtures of liquids that are toxic by inhalation shall be assigned to packing groups according to 2.6.2.2.4.7 or 2.6.2.2.4.8.

2.6.2.2.4.7 If LC<sub>50</sub> data are available for each of the toxic substances comprising a mixture, the packing group may be determined as follows:

- .1 Estimate the LC<sub>50</sub> of the mixture using the formula:

$$LC_{50} (\text{mixture}) = \frac{1}{\sum_{i=1}^n \left( \frac{f_i}{LC_{50i}} \right)}$$

where:  $f_i$  = mole fraction of the  $i^{\text{th}}$  component substance of the mixture  
 $LC_{50i}$  = mean lethal concentration of the  $i^{\text{th}}$  component substance in mL/m<sup>3</sup>.

- .2 Estimate the volatility of each component substance comprising the mixture using the formula:

$$V_i = \left( \frac{P_i \times 10^6}{101.3} \right) \text{mL/m}^3$$

where:  $P_i$  = the partial pressure of the  $i^{\text{th}}$  component substance in kPa at 20°C and one atmosphere pressure.

- .3 Calculate the ratio of the volatility to the LC<sub>50</sub> using the formula:

$$R = \sum_{i=1}^n \left( \frac{V_i}{LC_{50i}} \right)$$

- .4 Using the calculated values of  $LC_{50}$  (mixture) and  $R$ , the packing group for the mixture is determined:
- Packing group I:  $R \geq 10$  and  $LC_{50}$  (mixture)  $\leq 1,000$  mL/m<sup>3</sup>.
- Packing group II:  $R \geq 1$  and  $LC_{50}$  (mixture)  $\leq 3,000$  mL/m<sup>3</sup> and not meeting criteria for packing group I.
- Packing group III:  $R \geq \frac{1}{5}$  and  $LC_{50}$  (mixture)  $\leq 5,000$  mL/m<sup>3</sup> and not meeting criteria for packing groups I or II.

2.6.2.2.4.8 In the absence of  $LC_{50}$  data on the toxic constituent substances, the mixture may be assigned a packing group based on the following simplified threshold toxicity tests. When these threshold tests are used, the most restrictive packing group shall be determined and used for transporting the mixture.

- .1 A mixture is assigned to packing group I only if it meets both of the following criteria:
- A sample of the liquid mixture is vaporized and diluted with air to create a test atmosphere of 1,000 mL/m<sup>3</sup> vaporized mixture in air. Ten albino rats (five male and five female) are exposed to the test atmosphere for one hour and observed for 14 days. If five or more of the animals die within the 14-day observation period, the mixture is presumed to have an  $LC_{50}$  equal to or less than 1,000 mL/m<sup>3</sup>.
  - A sample of the vapour in equilibrium with the liquid mixture at 20°C is diluted with 9 equal volumes of air to form a test atmosphere. Ten albino rats (five male and five female) are exposed to the test atmosphere for one hour and observed for 14 days. If five or more of the animals die within the 14-day observation period, the mixture is presumed to have a volatility equal to or greater than 10 times the mixture  $LC_{50}$ .
- .2 A mixture is assigned to packing group II only if it meets both of the following criteria, and the mixture does not meet the criteria for packing group I:
- A sample of the liquid mixture is vaporized and diluted with air to create a test atmosphere of 3,000 mL/m<sup>3</sup> vaporized mixture in air. Ten albino rats (five male and five female) are exposed to the test atmosphere for one hour and observed for 14 days. If five or more of the animals die within the 14-day observation period, the mixture is presumed to have an  $LC_{50}$  equal to or less than 3,000 mL/m<sup>3</sup>.
  - A sample of the vapour in equilibrium with the liquid mixture at 20°C is used to form a test atmosphere. Ten albino rats (five male and five female) are exposed to the test atmosphere for one hour and observed for 14 days. If five or more of the animals die within the 14-day observation period, the mixture is presumed to have a volatility equal to or greater than the mixture  $LC_{50}$ .
- .3 A mixture is assigned to packing group III only if it meets both of the following criteria, and the mixture does not meet the criteria for packing groups I or II:
- A sample of the liquid mixture is vaporized and diluted with air to create a test atmosphere of 5,000 mL/m<sup>3</sup> vaporized mixture in air. Ten albino rats (five male and five female) are exposed to the test atmosphere for one hour and observed for 14 days. If five or more of the animals die within the 14-day observation period, the mixture is presumed to have an  $LC_{50}$  equal to or less than 5,000 mL/m<sup>3</sup>.
  - The vapour pressure of the liquid mixture is measured and if the vapour concentration is equal to or greater than 1,000 mL/m<sup>3</sup>, the mixture is presumed to have a volatility equal to or greater than  $\frac{1}{5}$  the mixture  $LC_{50}$ .

### 2.6.2.3 Methods for determining oral and dermal toxicity of mixtures

2.6.2.3.1 When classifying and assigning the appropriate packing group to mixtures in class 6.1, in accordance with the oral and dermal toxicity criteria in 2.6.2.2, it is necessary to determine the acute  $LD_{50}$  of the mixture.

2.6.2.3.2 If a mixture contains only one active substance, and the  $LD_{50}$  of that constituent is known, in the absence of reliable acute oral and dermal toxicity data on the actual mixture to be transported, the oral or dermal  $LD_{50}$  may be obtained by the following method:

$$LD_{50} \text{ value of preparation} = \frac{LD_{50} \text{ value of active substance} \times 100}{\text{percentage of active substance by mass}}$$

2.6.2.3.3 If a mixture contains more than one active constituent, there are three possible approaches that may be used to determine the oral or dermal  $LD_{50}$  of the mixture. The preferred method is to obtain reliable acute oral and dermal toxicity data on the actual mixture to be transported. If reliable, accurate data are not available, then either of the following methods may be performed:

- .1 Classify the formulation according to the most hazardous constituent of the mixture as if that constituent were present in the same concentration as the total concentration of all active constituents; or

## Part 2 – Classification

.2 Apply the formula:

$$\frac{C_A}{T_A} + \frac{C_B}{T_B} + \dots + \frac{C_Z}{T_Z} = \frac{100}{T_M}$$

where:

$C$  = the % concentration of constituent A, B ... Z in the mixture;

$T$  = the oral LD<sub>50</sub> value of constituent A, B ... Z;

$T_M$  = the oral LD<sub>50</sub> value of the mixture.

**Note:** This formula can also be used for dermal toxicities provided that this information is available on the same species for all constituents. The use of this formula does not take into account any potentiation or protective phenomena.

#### 2.6.2.4 Classification of pesticides

2.6.2.4.1 All active pesticide substances and their preparations for which the LC<sub>50</sub> and/or LD<sub>50</sub> values are known and which are classified in class 6.1 shall be classified under appropriate packing groups in accordance with the criteria given in 2.6.2.2. Substances and preparations which are characterized by subsidiary hazards shall be classified according to the precedence of hazard table in 2.0.3 with the assignment of appropriate packing groups.

2.6.2.4.2 If the oral or dermal LD<sub>50</sub> value for a pesticide preparation is not known, but the LD<sub>50</sub> value of its active substance(s) is known, the LD<sub>50</sub> value for the preparation may be obtained by applying the procedures in 2.6.2.3.

**Note:** LD<sub>50</sub> toxicity data for a number of common pesticides may be obtained from the most current edition of *The WHO Recommended Classification of Pesticides by Hazard and Guidelines to Classification*, available from the International Programme on Chemical Safety, World Health Organization (WHO), 1211 Geneva 27, Switzerland. While that publication may be used as a source of LD<sub>50</sub> data for pesticides, its classification system shall not be used for purposes of transport classification of, or assignment of packing groups to, pesticides, which shall be in accordance with the provisions of this Code.

2.6.2.4.3 The proper shipping name used in the transport of the pesticide shall be selected from those referenced on the basis of the active ingredient, of the physical state of the pesticide and any subsidiary hazards which it may exhibit.

#### 2.6.2.5 Substances not accepted for transport

Chemically unstable substances of class 6.1 shall not be accepted for transport unless the necessary precautions have been taken to prevent the possibility of a dangerous decomposition or polymerization under normal conditions of transport. For the precautions necessary to prevent polymerization, see special provision 386 of chapter 3.3. To this end particular care shall be taken to ensure that receptacles and tanks do not contain any substances liable to promote these reactions.

### 2.6.3 Class 6.2 – Infectious substances

#### 2.6.3.1 Definitions

For the purposes of this Code:

2.6.3.1.1 *Infectious substances* are substances which are known or are reasonably expected to contain pathogens. Pathogens are defined as micro-organisms (including bacteria, viruses, parasites, fungi) and other agents such as prions, which can cause disease in humans or animals.

2.6.3.1.2 *Biological products* are those products derived from living organisms which are manufactured and distributed in accordance with the requirements of appropriate national authorities, which may have special licensing requirements, and are used either for prevention, treatment, or diagnosis of disease in humans or animals, or for development, experimental or investigation purposes related thereto. They include, but are not limited to, finished or unfinished products such as vaccines.

2.6.3.1.3 *Cultures* are the result of a process by which pathogens are intentionally propagated. This definition does not include human or animal patient specimens as defined in 2.6.3.1.4.



2.6.3.1.4 *Patient specimens* are those collected directly from humans or animals, including, but not limited to, excreta, secreta, blood and its components, tissue and tissue fluid swabs, and body parts being transported for purposes such as research, diagnosis, investigational activities, disease treatment and prevention.

2.6.3.1.5 [Reserved]

2.6.3.1.6 *Medical or clinical wastes* are wastes derived from the veterinary treatment of animals, the medical treatment of humans or from bio-research.

2.6.3.2 **Classification of infectious substances**

2.6.3.2.1 Infectious substances shall be classified in class 6.2 and assigned to UN 2814, UN 2900, UN 3291, UN 3373 or UN 3549, as appropriate.

2.6.3.2.2 Infectious substances are divided into the following categories:

2.6.3.2.2.1 *Category A*: An infectious substance which is transported in a form that, when exposure to it occurs, is capable of causing permanent disability, life-threatening or fatal disease in otherwise healthy humans or animals. Indicative examples of substances that meet these criteria are given in the table in this paragraph.

**Note:** An exposure occurs when an infectious substance is released outside the protective packaging, resulting in physical contact with humans or animals.

.1 Infectious substances meeting these criteria which cause disease in humans or in both humans and animals shall be assigned to UN 2814. Infectious substances which cause disease only in animals shall be assigned to UN 2900.

.2 Assignment to UN 2814 or UN 2900 shall be based on the known medical history and symptoms of the source, human or animal, endemic local conditions, or professional judgement concerning individual circumstances of the human or animal source.

**Note 1:** The proper shipping name for UN 2814 is INFECTIOUS SUBSTANCE, AFFECTING HUMANS. The proper shipping name for UN 2900 is INFECTIOUS SUBSTANCE, AFFECTING ANIMALS only.

**Note 2:** The following table is not exhaustive. Infectious substances, including new or emerging pathogens, which do not appear in the table but which meet the same criteria shall be assigned to category A. In addition, if there is doubt as to whether or not a substance meets the criteria it shall be included in category A.

**Note 3:** In the following table, the microorganism names written in italics are bacteria or fungi.

Indicative examples of infectious substances included in category A in any form unless otherwise indicated (2.6.3.2.2.1.1)

| UN number and proper shipping name                | Microorganism  |
|---|--|
| UN 2814<br>Infectious substance, affecting humans | <i>Bacillus anthracis</i> (cultures only)<br><i>Brucella abortus</i> (cultures only)<br><i>Brucella melitensis</i> (cultures only)<br><i>Brucella suis</i> (cultures only)<br><i>Burkholderia mallei</i> – <i>Pseudomonas mallei</i> – Glanders (cultures only)<br><i>Burkholderia pseudomallei</i> – <i>Pseudomonas pseudomallei</i> (cultures only)<br><i>Chlamydia psittaci</i> – avian strains (cultures only)<br><i>Clostridium botulinum</i> (cultures only)<br><i>Coccidioides immitis</i> (cultures only)<br><i>Coxiella burnetii</i> (cultures only)<br>Crimean-Congo hemorrhagic fever virus<br>Dengue virus (cultures only)<br>Eastern equine encephalitis virus (cultures only)<br><i>Escherichia coli</i> , verotoxigenic (cultures only)<br>Ebola virus<br>Flexal virus<br><i>Francisella tularensis</i> (cultures only)<br>Guanarito virus<br>Hantaan virus |



Part 2 – Classification



| UN number and proper shipping name                                    | Microorganism   |
|---|---|
| <p>UN 2814<br/>Infectious substance, affecting humans<br/>(cont.)</p> | <p>Hantavirus causing hemorrhagic fever with renal syndrome<br/>Hendra virus<br/>Hepatitis B virus (cultures only)<br/>Herpes B virus (cultures only)<br/>Human immunodeficiency virus (cultures only)<br/>Highly pathogenic avian influenza virus (cultures only)<br/>Japanese Encephalitis virus (cultures only)<br/>Junin virus<br/>Kysanur Forest disease virus<br/>Lassa virus<br/>Machupo virus<br/>Marburg virus<br/>Monkeypox virus (cultures only)<br/><i>Mycobacterium tuberculosis</i> (cultures only)<br/>Nipah virus<br/>Omsk hemorrhagic fever virus<br/>Poliovirus (cultures only)<br/>Rabies virus (cultures only)<br/><i>Rickettsia prowazekii</i> (cultures only)<br/><i>Rickettsia rickettsii</i> (cultures only)<br/>Rift Valley fever virus (cultures only)<br/>Russian spring–summer encephalitis virus (cultures only)<br/>Sabia virus<br/><i>Shigella dysenteriae</i> type 1 (cultures only)<br/>Tick-borne encephalitis virus (cultures only)<br/>Variola virus<br/>Venezuelan equine encephalitis virus (cultures only)<br/>West Nile virus (cultures only)<br/>Yellow fever virus (cultures only)<br/><i>Yersinia pestis</i> (cultures only)</p> |
| <p>UN 2900<br/>Infectious substance, affecting animals only</p>       | <p>African swine fever virus (cultures only)<br/>Avian paramyxovirus Type 1 – Velogenic Newcastle disease virus (cultures only)<br/>Classical swine fever virus (cultures only)<br/>Foot and mouth disease virus (cultures only)<br/>Lumpy skin disease virus (cultures only)<br/><i>Mycoplasma mycoides</i> – Contagious bovine pleuropneumonia (cultures only)<br/>Peste des petits ruminants virus (cultures only)<br/>Rinderpest virus (cultures only)<br/>Sheep-pox virus (cultures only)<br/>Goatpox virus (cultures only)<br/>Swine vesicular disease virus (cultures only)<br/>Vesicular stomatitis virus (cultures only)</p>   |

△

2.6.3.2.2.2 *Category B*: An infectious substance which does not meet the criteria for inclusion in category A. Infectious substances in category B shall be assigned to UN 3373.

**Note:** The proper shipping name for UN 3373 is BIOLOGICAL SUBSTANCE, CATEGORY B.

2.6.3.2.3 *Exemptions*

2.6.3.2.3.1 Substances which do not contain infectious substances or substances which are unlikely to cause disease in humans or animals are not subject to the provisions of this Code, unless they meet the criteria for inclusion in another class.

2.6.3.2.3.2 Substances containing microorganisms which are non-pathogenic to humans or animals are not subject to the provisions of this Code unless they meet the criteria for inclusion in another class.

2.6.3.2.3.3 Substances in a form that any present pathogens have been neutralized or inactivated such that they no longer pose a health risk are not subject to the provisions of this Code unless they meet the criteria for inclusion in another class.

**Note:** Medical equipment which has been drained of free liquid is deemed to meet the requirements of this paragraph and is not subject to the provisions of this Code.

- 2.6.3.2.3.4 Environmental samples (including food and water samples) which are not considered to pose a significant risk of infection are not subject to the provisions of this Code unless they meet the criteria for inclusion in another class.
- 2.6.3.2.3.5 Dried blood spots, collected by applying a drop of blood onto absorbent material, are not subject to the provisions of this Code.
- 2.6.3.2.3.6 Faecal occult blood screening samples are not subject to the provisions of this Code.
- 2.6.3.2.3.7 Blood or blood components which have been collected for the purposes of transfusion or for the preparation of blood products to be used for transfusion or transplantation and any tissues or organs intended for use in transplantation as well as samples drawn in connection with such purposes are not subject to the provisions of this Code.
- 2.6.3.2.3.8 Human or animal specimens for which there is minimal likelihood that pathogens are present are not subject to the provisions of this Code if the specimen is transported in a packaging which will prevent any leakage and which is marked with the words “EXEMPT HUMAN SPECIMEN” or “EXEMPT ANIMAL SPECIMEN”, as appropriate. The packaging should meet the following conditions:
- .1 The packaging should consist of three components:
    - .1 a leak-proof primary receptacle(s);
    - .2 a leak-proof secondary packaging; and
    - .3 an outer packaging of adequate strength for its capacity, mass and intended use, and with at least one surface having minimum dimensions of 100 mm × 100 mm.
  - .2 For liquids, absorbent material in sufficient quantity to absorb the entire contents should be placed between the primary receptacle(s) and the secondary packaging so that, during transport, any release or leak of a liquid substance will not reach the outer packaging and will not compromise the integrity of the cushioning material.
  - .3 When multiple fragile primary receptacles are placed in a single secondary packaging, they should be either individually wrapped or separated to prevent contact between them.

**Note:** An element of professional judgement is required to determine if a substance is exempt under this paragraph. That judgement should be based on the known medical history, symptoms and individual circumstances of the source, human or animal, and endemic local conditions. Examples of specimens which may be transported under this paragraph include the blood or urine tests to monitor cholesterol levels, blood glucose levels, hormone levels, or prostate specific antibodies (PSA); those required to monitor organ function such as heart, liver or kidney function for humans or animals with non-infectious diseases, or therapeutic drug monitoring; those conducted for insurance or employment purposes and are intended to determine the presence of drugs or alcohol; pregnancy test; biopsies to detect cancer; and antibody detection in humans or animals in the absence of any concern for infection (e.g. evaluation of vaccine-induced immunity, diagnosis of autoimmune disease, etc.).

- 2.6.3.2.3.9 Except for:
- .1 medical waste (UN 3291 and UN 3549);
  - .2 medical devices or equipment contaminated with or containing infectious substances in category A (UN 2814 or UN 2900); and
  - .3 medical devices or equipment contaminated with or containing other dangerous goods that meet the definition of another hazard class,

medical devices or equipment potentially contaminated with or containing infectious substances which are being transported for disinfection, cleaning, sterilization, repair, or equipment evaluation are not subject to the provisions of this Code if packed in packagings designed and constructed in such a way that, under normal conditions of transport, they cannot break, be punctured or leak their contents. Packagings shall be designed to meet the construction requirements listed in 6.1.4 or 6.6.4.

These packagings shall meet the general packing requirements of 4.1.1.1 and 4.1.1.2 and be capable of retaining the medical devices and equipment when dropped from a height of 1.2 m.

The packagings shall be marked “USED MEDICAL DEVICE” or “USED MEDICAL EQUIPMENT”. When using overpacks or unit loads these shall be marked in the same way, except when the inscription remains visible.

## Part 2 – Classification

---

### 2.6.3.3 Biological products

2.6.3.3.1 For the purposes of this Code, biological products are divided into the following groups:

- .1 those which are manufactured and packaged in accordance with the requirements of appropriate national authorities and transported for the purposes of final packaging or distribution, and use for personal health care by medical professionals or individuals. Substances in this group are not subject to the provisions of this Code;
- .2 those which do not fall under .1 and are known or reasonably believed to contain infectious substances and which meet the criteria for inclusion in category A or category B. Substances in this group shall be assigned to UN 2814, UN 2900 or UN 3373, as appropriate.

**Note:** Some licensed biological products may present a biohazard only in certain parts of the world. Competent authorities may require that such biological products comply with local requirements for infectious substances or may impose other restrictions.

### 2.6.3.4 Genetically modified microorganisms and organisms

2.6.3.4.1 Genetically modified microorganisms not meeting the definition of infectious substance shall be classified in accordance with chapter 2.9.

### 2.6.3.5 Medical or clinical wastes

2.6.3.5.1 Medical or clinical waste containing:

- .1 Category A infectious substances shall be assigned to UN 2814, UN 2900 or UN 3549 as appropriate. Solid medical waste containing Category A infectious substances generated from the medical treatment of humans or veterinary treatment of animals may be assigned to UN 3549. The UN 3549 entry shall not be used for waste from bio-research or liquid waste;
- .2 Category B infectious substances shall be assigned to UN 3291.

2.6.3.5.2 Medical or clinical wastes which are reasonably believed to have a low probability of containing infectious substances shall be assigned to UN 3291. For the assignment, international, regional or national waste catalogues may be taken into account.

**Note:** The proper shipping name for UN 3291 is CLINICAL WASTE, UNSPECIFIED, N.O.S. or (BIO) MEDICAL WASTE, N.O.S. or REGULATED MEDICAL WASTE, N.O.S.

2.6.3.5.3 Decontaminated medical or clinical wastes which previously contained infectious substances are not subject to the provisions of this Code unless they meet the criteria for inclusion in another class.

### 2.6.3.6 Infected animals

2.6.3.6.1 Unless an infectious substance cannot be consigned by any other means, live animals shall not be used to consign such a substance. A live animal which has been intentionally infected and is known or suspected to contain an infectious substance shall only be transported under terms and conditions approved by the competent authority.

## Chapter 2.7

### Class 7 – Radioactive material

**Note:** For class 7, the type of packaging may have a decisive effect on classification.

#### 2.7.1 Definitions

2.7.1.1 *Radioactive material* means any material containing radionuclides where both the activity concentration and the total activity in the consignment exceed the values specified in 2.7.2.2.1 to 2.7.2.2.6.

#### 2.7.1.2 Contamination

*Contamination* means the presence of a radioactive substance on a surface in quantities in excess of 0.4 Bq/cm<sup>2</sup> for beta and gamma emitters and low-toxicity alpha emitters, or 0.04 Bq/cm<sup>2</sup> for all other alpha emitters.

*Non-fixed contamination* means contamination that can be removed from a surface during routine conditions of transport.

*Fixed contamination* means contamination other than non-fixed contamination.

#### 2.7.1.3 Definitions of specific terms

$A_1$  and  $A_2$

$A_1$  means the activity value of special form radioactive material which is listed in the table in 2.7.2.2.1 or derived in 2.7.2.2.2 and is used to determine the activity limits for the provisions of this Code.

$A_2$  means the activity value of radioactive material, other than special form radioactive material, which is listed in the table in 2.7.2.2.1 or derived in 2.7.2.2.2 and is used to determine the activity limits for the provisions of this Code.

*Fissile nuclides* means uranium-233, uranium-235, plutonium-239 and plutonium-241. *Fissile material* means a material containing any of the fissile nuclides. Excluded from the definition of fissile material are the following:

- .1 natural uranium or depleted uranium which is unirradiated;
- .2 natural uranium or depleted uranium which has been irradiated in thermal reactors only;
- .3 material with fissile nuclides less than a total of 0.25 g;
- .4 any combination of .1, .2 and/or .3.

These exclusions are only valid if there is no other material with fissile nuclides in the package or in the consignment if shipped unpackaged.

*Low dispersible radioactive material* means either a solid radioactive material or a solid radioactive material in a sealed capsule, that has limited dispersibility and is not in powder form.

*Low specific activity (LSA) material* means radioactive material which by its nature has a limited specific activity, or radioactive material for which limits of estimated average specific activity apply. External shielding materials surrounding the LSA material shall not be considered in determining the estimated average specific activity.

*Low toxicity alpha emitters* are: natural uranium; depleted uranium; natural thorium; uranium-235 or uranium-238; thorium-232; thorium-228 and thorium-230 when contained in ores or physical and chemical concentrates; or alpha emitters with a half-life of less than 10 days.

*Specific activity of a radionuclide* means the activity per unit mass of that nuclide. The specific activity of a material shall mean the activity per unit mass of the material in which the radionuclides are essentially uniformly distributed.

■ **Note:** The terms “activity concentration” and “specific activity” are synonymous for the purpose of this Code.

Part 2 – Classification

*Special form radioactive material* means either:

- .1 an indispersible solid radioactive material; or
- .2 a sealed capsule containing radioactive material.

*Surface contaminated object (SCO)* means a solid object which is not itself radioactive but which has radioactive material distributed on its surface.

*Unirradiated thorium* means thorium containing not more than  $10^{-7}$  g of uranium-233 per gram of thorium-232.

*Unirradiated uranium* means uranium containing not more than  $2 \times 10^3$  Bq of plutonium per gram of uranium-235, not more than  $9 \times 10^6$  Bq of fission products per gram of uranium-235 and not more than  $5 \times 10^{-3}$  g of uranium-236 per gram of uranium-235.

*Uranium – natural, depleted, enriched* means the following:

*Natural uranium* means uranium (which may be chemically separated) containing the naturally occurring distribution of uranium isotopes (approximately 99.28% uranium-238, and 0.72% uranium-235 by mass).

*Depleted uranium* means uranium containing a lesser mass percentage of uranium-235 than in natural uranium.

*Enriched uranium* means uranium containing a greater mass percentage of uranium-235 than 0.72%.

In all cases, a very small mass percentage of uranium-234 is present.

## 2.7.2 Classification

### 2.7.2.1 General provisions

2.7.2.1.1 Radioactive material shall be assigned to one of the UN numbers specified in table 2.7.2.1.1, in accordance with 2.7.2.4 and 2.7.2.5, taking into account the material characteristics determined in 2.7.2.3.

Table 2.7.2.1.1 – Assignment of UN numbers

| UN numbers  | Proper shipping name <sup>a</sup> and description  |
|---|--|
| <b>Excepted packages (1.5.1.5)</b>                            |  |
| 2908  | RADIOACTIVE MATERIAL, EXCEPTED PACKAGE – EMPTY PACKAGING   |
| 2909  | RADIOACTIVE MATERIAL, EXCEPTED PACKAGE – ARTICLES MANUFACTURED FROM NATURAL URANIUM or DEPLETED URANIUM or NATURAL THORIUM                 |
| 2910  | RADIOACTIVE MATERIAL, EXCEPTED PACKAGE – LIMITED QUANTITY OF MATERIAL  |
| 2911  | RADIOACTIVE MATERIAL, EXCEPTED PACKAGE – INSTRUMENTS or ARTICLES   |
| 3507  | URANIUM HEXAFLUORIDE, RADIOACTIVE MATERIAL, EXCEPTED PACKAGE less than 0.1 kg per package, non-fissile or fissile-excepted <sup>b, c</sup> |
| <b>Low specific activity radioactive material (2.7.2.3.1)</b> |  |
| 2912  | RADIOACTIVE MATERIAL, LOW SPECIFIC ACTIVITY (LSA-I), non-fissile or fissile-excepted <sup>b</sup>  |
| 3321  | RADIOACTIVE MATERIAL, LOW SPECIFIC ACTIVITY (LSA-II), non-fissile or fissile-excepted <sup>b</sup>   |
| 3322  | RADIOACTIVE MATERIAL, LOW SPECIFIC ACTIVITY (LSA-III), non-fissile or fissile-excepted <sup>b</sup>  |
| 3324  | RADIOACTIVE MATERIAL, LOW SPECIFIC ACTIVITY (LSA-II), FISSILE  |
| 3325  | RADIOACTIVE MATERIAL, LOW SPECIFIC ACTIVITY (LSA-III), FISSILE   |
| <b>Surface contaminated objects (2.7.2.3.2)</b>               |  |
| 2913  | RADIOACTIVE MATERIAL, SURFACE CONTAMINATED OBJECTS (SCO-I, SCO-II or SCO-III), non-fissile or fissile-excepted <sup>b</sup>                |
| 3326  | RADIOACTIVE MATERIAL, SURFACE CONTAMINATED OBJECTS (SCO-I or SCO-II), FISSILE  |
| <b>Type A packages (2.7.2.4.4)</b>                            |  |
| 2915  | RADIOACTIVE MATERIAL, TYPE A PACKAGE, non-special form, non-fissile or fissile-excepted <sup>b</sup>                                       |
| 3327  | RADIOACTIVE MATERIAL, TYPE A PACKAGE, FISSILE, non-special form  |
| 3332  | RADIOACTIVE MATERIAL, TYPE A PACKAGE, SPECIAL FORM, non-fissile or fissile-excepted <sup>b</sup>   |
| 3333  | RADIOACTIVE MATERIAL, TYPE A PACKAGE, SPECIAL FORM, FISSILE  |

| UN numbers                              | Proper shipping name <sup>a</sup> and description  |
|---|--|
| <b>Type B(U) package (2.7.2.4.6)</b>    |  |
| 2916                                    | RADIOACTIVE MATERIAL, TYPE B(U) PACKAGE, non-fissile or fissile-excepted <sup>b</sup>  |
| 3328                                    | RADIOACTIVE MATERIAL, TYPE B(U) PACKAGE, FISSILE   |
| <b>Type B(M) package (2.7.2.4.6)</b>    |  |
| 2917                                    | RADIOACTIVE MATERIAL, TYPE B(M) PACKAGE, non-fissile or fissile-excepted <sup>b</sup>  |
| 3329                                    | RADIOACTIVE MATERIAL, TYPE B(M) PACKAGE, FISSILE   |
| <b>Type C package (2.7.2.4.6)</b>       |  |
| 3323                                    | RADIOACTIVE MATERIAL, TYPE C PACKAGE, non-fissile or fissile-excepted <sup>b</sup>   |
| 3330                                    | RADIOACTIVE MATERIAL, TYPE C PACKAGE, FISSILE  |
| <b>Special arrangement (2.7.2.5)</b>    |  |
| 2919                                    | RADIOACTIVE MATERIAL, TRANSPORTED UNDER SPECIAL ARRANGEMENT, non-fissile or fissile-excepted <sup>b</sup>                                  |
| 3331                                    | RADIOACTIVE MATERIAL, TRANSPORTED UNDER SPECIAL ARRANGEMENT, FISSILE   |
| <b>Uranium hexafluoride (2.7.2.4.5)</b> |  |
| 2977                                    | RADIOACTIVE MATERIAL, URANIUM HEXAFLUORIDE, FISSILE  |
| 2978                                    | RADIOACTIVE MATERIAL, URANIUM HEXAFLUORIDE, non-fissile or fissile-excepted <sup>b</sup>   |
| 3507                                    | URANIUM HEXAFLUORIDE, RADIOACTIVE MATERIAL, EXCEPTED PACKAGE less than 0.1 kg per package, non-fissile or fissile-excepted <sup>b, c</sup> |

<sup>a</sup> The proper shipping name is found in the column “Proper shipping name and description” and is restricted to that part shown in capital letters. In the cases of UN Nos. 2909, 2911, 2913 and 3326, where alternative proper shipping names are separated by the word “or”, only the relevant proper shipping name shall be used.

<sup>b</sup> The term “fissile-excepted” refers only to material excepted under 2.7.2.3.5.

<sup>c</sup> For UN 3507, see also special provision 369 in chapter 3.3.

## 2.7.2.2 Determination of activity level

2.7.2.2.1 The following basic values for individual radionuclides are given in table 2.7.2.2.1:

- .1  $A_1$  and  $A_2$  in TBq;
- .2 Activity concentration limits for exempt material in Bq/g; and
- .3 Activity limits for exempt consignments in Bq.

Table 2.7.2.2.1 – Basic radionuclides values for individual radionuclides

| Radionuclide (atomic number) | $A_1$<br>(TBq)     | $A_2$<br>(TBq)     | Activity concentration limit for exempt material (Bq/g) | Activity limit for an exempt consignment (Bq) |
|------------------------------|--------------------|--------------------|---|---|
| <b>Actinium (89)</b>         |                    |                    |   |   |
| Ac-225 (a)                   | $8 \times 10^{-1}$ | $6 \times 10^{-3}$ | $1 \times 10^1$   | $1 \times 10^4$                               |
| Ac-227 (a)                   | $9 \times 10^{-1}$ | $9 \times 10^{-5}$ | $1 \times 10^{-1}$                                      | $1 \times 10^3$                               |
| Ac-228                       | $6 \times 10^{-1}$ | $5 \times 10^{-1}$ | $1 \times 10^1$   | $1 \times 10^6$                               |
| <b>Silver (47)</b>           |                    |                    |   |   |
| Ag-105                       | $2 \times 10^0$    | $2 \times 10^0$    | $1 \times 10^2$   | $1 \times 10^6$                               |
| Ag-108m (a)                  | $7 \times 10^{-1}$ | $7 \times 10^{-1}$ | $1 \times 10^1$ (b)                                     | $1 \times 10^6$ (b)                           |
| Ag-110m (a)                  | $4 \times 10^{-1}$ | $4 \times 10^{-1}$ | $1 \times 10^1$   | $1 \times 10^6$                               |
| Ag-111                       | $2 \times 10^0$    | $6 \times 10^{-1}$ | $1 \times 10^3$   | $1 \times 10^6$                               |
| <b>Aluminium (13)</b>        |                    |                    |   |   |
| Al-26                        | $1 \times 10^{-1}$ | $1 \times 10^{-1}$ | $1 \times 10^1$   | $1 \times 10^5$                               |
| <b>Americium (95)</b>        |                    |                    |   |   |
| Am-241                       | $1 \times 10^1$    | $1 \times 10^{-3}$ | $1 \times 10^0$   | $1 \times 10^4$                               |
| Am-242m (a)                  | $1 \times 10^1$    | $1 \times 10^{-3}$ | $1 \times 10^0$ (b)                                     | $1 \times 10^4$ (b)                           |
| Am-243 (a)                   | $5 \times 10^0$    | $1 \times 10^{-3}$ | $1 \times 10^0$ (b)                                     | $1 \times 10^3$ (b)                           |

Part 2 – Classification

| Radionuclide (atomic number) | A <sub>1</sub><br>(TBq) | A <sub>2</sub><br>(TBq) | Activity concentration limit for exempt material (Bq/g) | Activity limit for an exempt consignment (Bq) |
|------------------------------|-------------------------|-------------------------|---|---|
| <b>Argon (18)</b>            |                         |                         |   |   |
| Ar-37                        | 4 × 10 <sup>1</sup>     | 4 × 10 <sup>1</sup>     | 1 × 10 <sup>6</sup>                                     | 1 × 10 <sup>8</sup>                           |
| Ar-39                        | 4 × 10 <sup>1</sup>     | 2 × 10 <sup>1</sup>     | 1 × 10 <sup>7</sup>                                     | 1 × 10 <sup>4</sup>                           |
| Ar-41                        | 3 × 10 <sup>-1</sup>    | 3 × 10 <sup>-1</sup>    | 1 × 10 <sup>2</sup>                                     | 1 × 10 <sup>9</sup>                           |
| <b>Arsenic (33)</b>          |                         |                         |   |   |
| As-72                        | 3 × 10 <sup>-1</sup>    | 3 × 10 <sup>-1</sup>    | 1 × 10 <sup>1</sup>                                     | 1 × 10 <sup>5</sup>                           |
| As-73                        | 4 × 10 <sup>1</sup>     | 4 × 10 <sup>1</sup>     | 1 × 10 <sup>3</sup>                                     | 1 × 10 <sup>7</sup>                           |
| As-74                        | 1 × 10 <sup>0</sup>     | 9 × 10 <sup>-1</sup>    | 1 × 10 <sup>1</sup>                                     | 1 × 10 <sup>6</sup>                           |
| As-76                        | 3 × 10 <sup>-1</sup>    | 3 × 10 <sup>-1</sup>    | 1 × 10 <sup>2</sup>                                     | 1 × 10 <sup>5</sup>                           |
| As-77                        | 2 × 10 <sup>1</sup>     | 7 × 10 <sup>-1</sup>    | 1 × 10 <sup>3</sup>                                     | 1 × 10 <sup>6</sup>                           |
| <b>Astatine (85)</b>         |                         |                         |   |   |
| At-211 (a)                   | 2 × 10 <sup>1</sup>     | 5 × 10 <sup>-1</sup>    | 1 × 10 <sup>3</sup>                                     | 1 × 10 <sup>7</sup>                           |
| <b>Gold (79)</b>             |                         |                         |   |   |
| Au-193                       | 7 × 10 <sup>0</sup>     | 2 × 10 <sup>0</sup>     | 1 × 10 <sup>2</sup>                                     | 1 × 10 <sup>7</sup>                           |
| Au-194                       | 1 × 10 <sup>0</sup>     | 1 × 10 <sup>0</sup>     | 1 × 10 <sup>1</sup>                                     | 1 × 10 <sup>6</sup>                           |
| Au-195                       | 1 × 10 <sup>1</sup>     | 6 × 10 <sup>0</sup>     | 1 × 10 <sup>2</sup>                                     | 1 × 10 <sup>7</sup>                           |
| Au-198                       | 1 × 10 <sup>0</sup>     | 6 × 10 <sup>-1</sup>    | 1 × 10 <sup>2</sup>                                     | 1 × 10 <sup>6</sup>                           |
| Au-199                       | 1 × 10 <sup>1</sup>     | 6 × 10 <sup>-1</sup>    | 1 × 10 <sup>2</sup>                                     | 1 × 10 <sup>6</sup>                           |
| <b>Barium (56)</b>           |                         |                         |   |   |
| Ba-131 (a)                   | 2 × 10 <sup>0</sup>     | 2 × 10 <sup>0</sup>     | 1 × 10 <sup>2</sup>                                     | 1 × 10 <sup>6</sup>                           |
| Ba-133                       | 3 × 10 <sup>0</sup>     | 3 × 10 <sup>0</sup>     | 1 × 10 <sup>2</sup>                                     | 1 × 10 <sup>6</sup>                           |
| Ba-133m                      | 2 × 10 <sup>1</sup>     | 6 × 10 <sup>-1</sup>    | 1 × 10 <sup>2</sup>                                     | 1 × 10 <sup>6</sup>                           |
| Ba-135m                      | 2 × 10 <sup>1</sup>     | 6 × 10 <sup>-1</sup>    | 1 × 10 <sup>2</sup>                                     | 1 × 10 <sup>6</sup>                           |
| Ba-140 (a)                   | 5 × 10 <sup>-1</sup>    | 3 × 10 <sup>-1</sup>    | 1 × 10 <sup>1</sup> (b)                                 | 1 × 10 <sup>5</sup> (b)                       |
| <b>Beryllium (4)</b>         |                         |                         |   |   |
| Be-7                         | 2 × 10 <sup>1</sup>     | 2 × 10 <sup>1</sup>     | 1 × 10 <sup>3</sup>                                     | 1 × 10 <sup>7</sup>                           |
| Be-10                        | 4 × 10 <sup>1</sup>     | 6 × 10 <sup>-1</sup>    | 1 × 10 <sup>4</sup>                                     | 1 × 10 <sup>6</sup>                           |
| <b>Bismuth (83)</b>          |                         |                         |   |   |
| Bi-205                       | 7 × 10 <sup>-1</sup>    | 7 × 10 <sup>-1</sup>    | 1 × 10 <sup>1</sup>                                     | 1 × 10 <sup>6</sup>                           |
| Bi-206                       | 3 × 10 <sup>-1</sup>    | 3 × 10 <sup>-1</sup>    | 1 × 10 <sup>1</sup>                                     | 1 × 10 <sup>5</sup>                           |
| Bi-207                       | 7 × 10 <sup>-1</sup>    | 7 × 10 <sup>-1</sup>    | 1 × 10 <sup>1</sup>                                     | 1 × 10 <sup>6</sup>                           |
| Bi-210                       | 1 × 10 <sup>0</sup>     | 6 × 10 <sup>-1</sup>    | 1 × 10 <sup>3</sup>                                     | 1 × 10 <sup>6</sup>                           |
| Bi-210m (a)                  | 6 × 10 <sup>-1</sup>    | 2 × 10 <sup>-2</sup>    | 1 × 10 <sup>1</sup>                                     | 1 × 10 <sup>5</sup>                           |
| Bi-212 (a)                   | 7 × 10 <sup>-1</sup>    | 6 × 10 <sup>-1</sup>    | 1 × 10 <sup>1</sup> (b)                                 | 1 × 10 <sup>5</sup> (b)                       |
| <b>Berkelium (97)</b>        |                         |                         |   |   |
| Bk-247                       | 8 × 10 <sup>0</sup>     | 8 × 10 <sup>-4</sup>    | 1 × 10 <sup>0</sup>                                     | 1 × 10 <sup>4</sup>                           |
| Bk-249 (a)                   | 4 × 10 <sup>1</sup>     | 3 × 10 <sup>-1</sup>    | 1 × 10 <sup>3</sup>                                     | 1 × 10 <sup>6</sup>                           |
| <b>Bromine (35)</b>          |                         |                         |   |   |
| Br-76                        | 4 × 10 <sup>-1</sup>    | 4 × 10 <sup>-1</sup>    | 1 × 10 <sup>1</sup>                                     | 1 × 10 <sup>5</sup>                           |
| Br-77                        | 3 × 10 <sup>0</sup>     | 3 × 10 <sup>0</sup>     | 1 × 10 <sup>2</sup>                                     | 1 × 10 <sup>6</sup>                           |
| Br-82                        | 4 × 10 <sup>-1</sup>    | 4 × 10 <sup>-1</sup>    | 1 × 10 <sup>1</sup>                                     | 1 × 10 <sup>6</sup>                           |
| <b>Carbon (6)</b>            |                         |                         |   |   |
| C-11                         | 1 × 10 <sup>0</sup>     | 6 × 10 <sup>-1</sup>    | 1 × 10 <sup>1</sup>                                     | 1 × 10 <sup>6</sup>                           |
| C-14                         | 4 × 10 <sup>1</sup>     | 3 × 10 <sup>0</sup>     | 1 × 10 <sup>4</sup>                                     | 1 × 10 <sup>7</sup>                           |
| <b>Calcium (20)</b>          |                         |                         |   |   |
| Ca-41                        | Unlimited               | Unlimited               | 1 × 10 <sup>5</sup>                                     | 1 × 10 <sup>7</sup>                           |
| Ca-45                        | 4 × 10 <sup>1</sup>     | 1 × 10 <sup>0</sup>     | 1 × 10 <sup>4</sup>                                     | 1 × 10 <sup>7</sup>                           |
| Ca-47 (a)                    | 3 × 10 <sup>0</sup>     | 3 × 10 <sup>-1</sup>    | 1 × 10 <sup>1</sup>                                     | 1 × 10 <sup>6</sup>                           |
| <b>Cadmium (48)</b>          |                         |                         |   |   |
| Cd-109                       | 3 × 10 <sup>1</sup>     | 2 × 10 <sup>0</sup>     | 1 × 10 <sup>4</sup>                                     | 1 × 10 <sup>6</sup>                           |
| Cd-113m                      | 4 × 10 <sup>1</sup>     | 5 × 10 <sup>-1</sup>    | 1 × 10 <sup>3</sup>                                     | 1 × 10 <sup>6</sup>                           |
| Cd-115 (a)                   | 3 × 10 <sup>0</sup>     | 4 × 10 <sup>-1</sup>    | 1 × 10 <sup>2</sup>                                     | 1 × 10 <sup>6</sup>                           |
| Cd-115m                      | 5 × 10 <sup>-1</sup>    | 5 × 10 <sup>-1</sup>    | 1 × 10 <sup>3</sup>                                     | 1 × 10 <sup>6</sup>                           |
| <b>Cerium (58)</b>           |                         |                         |   |   |
| Ce-139                       | 7 × 10 <sup>0</sup>     | 2 × 10 <sup>0</sup>     | 1 × 10 <sup>2</sup>                                     | 1 × 10 <sup>6</sup>                           |
| Ce-141                       | 2 × 10 <sup>1</sup>     | 6 × 10 <sup>-1</sup>    | 1 × 10 <sup>2</sup>                                     | 1 × 10 <sup>7</sup>                           |
| Ce-143                       | 9 × 10 <sup>-1</sup>    | 6 × 10 <sup>-1</sup>    | 1 × 10 <sup>2</sup>                                     | 1 × 10 <sup>6</sup>                           |
| Ce-144 (a)                   | 2 × 10 <sup>-1</sup>    | 2 × 10 <sup>-1</sup>    | 1 × 10 <sup>2</sup> (b)                                 | 1 × 10 <sup>5</sup> (b)                       |



| Radionuclide (atomic number) | A <sub>1</sub><br>(TBq) | A <sub>2</sub><br>(TBq) | Activity concentration limit for exempt material (Bq/g) | Activity limit for an exempt consignment (Bq) |
|------------------------------|-------------------------|-------------------------|---|---|
| <b>Californium (98)</b>      |                         |                         |   |   |
| Cf-248                       | 4 × 10 <sup>1</sup>     | 6 × 10 <sup>-3</sup>    | 1 × 10 <sup>1</sup>                                     | 1 × 10 <sup>4</sup>                           |
| Cf-249                       | 3 × 10 <sup>0</sup>     | 8 × 10 <sup>-4</sup>    | 1 × 10 <sup>0</sup>                                     | 1 × 10 <sup>3</sup>                           |
| Cf-250                       | 2 × 10 <sup>1</sup>     | 2 × 10 <sup>-3</sup>    | 1 × 10 <sup>1</sup>                                     | 1 × 10 <sup>4</sup>                           |
| Cf-251                       | 7 × 10 <sup>0</sup>     | 7 × 10 <sup>-4</sup>    | 1 × 10 <sup>0</sup>                                     | 1 × 10 <sup>3</sup>                           |
| Cf-252                       | 1 × 10 <sup>-1</sup>    | 3 × 10 <sup>-3</sup>    | 1 × 10 <sup>1</sup>                                     | 1 × 10 <sup>4</sup>                           |
| Cf-253 (a)                   | 4 × 10 <sup>1</sup>     | 4 × 10 <sup>-2</sup>    | 1 × 10 <sup>2</sup>                                     | 1 × 10 <sup>5</sup>                           |
| Cf-254                       | 1 × 10 <sup>-3</sup>    | 1 × 10 <sup>-3</sup>    | 1 × 10 <sup>0</sup>                                     | 1 × 10 <sup>3</sup>                           |
| <b>Chlorine (17)</b>         |                         |                         |   |   |
| Cl-36                        | 1 × 10 <sup>1</sup>     | 6 × 10 <sup>-1</sup>    | 1 × 10 <sup>4</sup>                                     | 1 × 10 <sup>6</sup>                           |
| Cl-38                        | 2 × 10 <sup>-1</sup>    | 2 × 10 <sup>-1</sup>    | 1 × 10 <sup>1</sup>                                     | 1 × 10 <sup>5</sup>                           |
| <b>Curium (96)</b>           |                         |                         |   |   |
| Cm-240                       | 4 × 10 <sup>1</sup>     | 2 × 10 <sup>-2</sup>    | 1 × 10 <sup>2</sup>                                     | 1 × 10 <sup>5</sup>                           |
| Cm-241                       | 2 × 10 <sup>0</sup>     | 1 × 10 <sup>0</sup>     | 1 × 10 <sup>2</sup>                                     | 1 × 10 <sup>6</sup>                           |
| Cm-242                       | 4 × 10 <sup>1</sup>     | 1 × 10 <sup>-2</sup>    | 1 × 10 <sup>2</sup>                                     | 1 × 10 <sup>5</sup>                           |
| Cm-243                       | 9 × 10 <sup>0</sup>     | 1 × 10 <sup>-3</sup>    | 1 × 10 <sup>0</sup>                                     | 1 × 10 <sup>4</sup>                           |
| Cm-244                       | 2 × 10 <sup>1</sup>     | 2 × 10 <sup>-3</sup>    | 1 × 10 <sup>1</sup>                                     | 1 × 10 <sup>4</sup>                           |
| Cm-245                       | 9 × 10 <sup>0</sup>     | 9 × 10 <sup>-4</sup>    | 1 × 10 <sup>0</sup>                                     | 1 × 10 <sup>3</sup>                           |
| Cm-246                       | 9 × 10 <sup>0</sup>     | 9 × 10 <sup>-4</sup>    | 1 × 10 <sup>0</sup>                                     | 1 × 10 <sup>3</sup>                           |
| Cm-247 (a)                   | 3 × 10 <sup>0</sup>     | 1 × 10 <sup>-3</sup>    | 1 × 10 <sup>0</sup>                                     | 1 × 10 <sup>4</sup>                           |
| Cm-248                       | 2 × 10 <sup>-2</sup>    | 3 × 10 <sup>-4</sup>    | 1 × 10 <sup>0</sup>                                     | 1 × 10 <sup>3</sup>                           |
| <b>Cobalt (27)</b>           |                         |                         |   |   |
| Co-55                        | 5 × 10 <sup>-1</sup>    | 5 × 10 <sup>-1</sup>    | 1 × 10 <sup>1</sup>                                     | 1 × 10 <sup>6</sup>                           |
| Co-56                        | 3 × 10 <sup>-1</sup>    | 3 × 10 <sup>-1</sup>    | 1 × 10 <sup>1</sup>                                     | 1 × 10 <sup>5</sup>                           |
| Co-57                        | 1 × 10 <sup>1</sup>     | 1 × 10 <sup>1</sup>     | 1 × 10 <sup>2</sup>                                     | 1 × 10 <sup>6</sup>                           |
| Co-58                        | 1 × 10 <sup>0</sup>     | 1 × 10 <sup>0</sup>     | 1 × 10 <sup>1</sup>                                     | 1 × 10 <sup>6</sup>                           |
| Co-58m                       | 4 × 10 <sup>1</sup>     | 4 × 10 <sup>1</sup>     | 1 × 10 <sup>4</sup>                                     | 1 × 10 <sup>7</sup>                           |
| Co-60                        | 4 × 10 <sup>-1</sup>    | 4 × 10 <sup>-1</sup>    | 1 × 10 <sup>1</sup>                                     | 1 × 10 <sup>5</sup>                           |
| <b>Chromium (24)</b>         |                         |                         |   |   |
| Cr-51                        | 3 × 10 <sup>1</sup>     | 3 × 10 <sup>1</sup>     | 1 × 10 <sup>3</sup>                                     | 1 × 10 <sup>7</sup>                           |
| <b>Caesium (55)</b>          |                         |                         |   |   |
| Cs-129                       | 4 × 10 <sup>0</sup>     | 4 × 10 <sup>0</sup>     | 1 × 10 <sup>2</sup>                                     | 1 × 10 <sup>5</sup>                           |
| Cs-131                       | 3 × 10 <sup>1</sup>     | 3 × 10 <sup>1</sup>     | 1 × 10 <sup>3</sup>                                     | 1 × 10 <sup>6</sup>                           |
| Cs-132                       | 1 × 10 <sup>0</sup>     | 1 × 10 <sup>0</sup>     | 1 × 10 <sup>1</sup>                                     | 1 × 10 <sup>5</sup>                           |
| Cs-134                       | 7 × 10 <sup>-1</sup>    | 7 × 10 <sup>-1</sup>    | 1 × 10 <sup>1</sup>                                     | 1 × 10 <sup>4</sup>                           |
| Cs-134m                      | 4 × 10 <sup>1</sup>     | 6 × 10 <sup>-1</sup>    | 1 × 10 <sup>3</sup>                                     | 1 × 10 <sup>5</sup>                           |
| Cs-135                       | 4 × 10 <sup>1</sup>     | 1 × 10 <sup>0</sup>     | 1 × 10 <sup>4</sup>                                     | 1 × 10 <sup>7</sup>                           |
| Cs-136                       | 5 × 10 <sup>-1</sup>    | 5 × 10 <sup>-1</sup>    | 1 × 10 <sup>1</sup>                                     | 1 × 10 <sup>5</sup>                           |
| Cs-137 (a)                   | 2 × 10 <sup>0</sup>     | 6 × 10 <sup>-1</sup>    | 1 × 10 <sup>1</sup> (b)                                 | 1 × 10 <sup>4</sup> (b)                       |
| <b>Copper (29)</b>           |                         |                         |   |   |
| Cu-64                        | 6 × 10 <sup>0</sup>     | 1 × 10 <sup>0</sup>     | 1 × 10 <sup>2</sup>                                     | 1 × 10 <sup>6</sup>                           |
| Cu-67                        | 1 × 10 <sup>1</sup>     | 7 × 10 <sup>-1</sup>    | 1 × 10 <sup>2</sup>                                     | 1 × 10 <sup>6</sup>                           |
| <b>Dysprosium (66)</b>       |                         |                         |   |   |
| Dy-159                       | 2 × 10 <sup>1</sup>     | 2 × 10 <sup>1</sup>     | 1 × 10 <sup>3</sup>                                     | 1 × 10 <sup>7</sup>                           |
| Dy-165                       | 9 × 10 <sup>-1</sup>    | 6 × 10 <sup>-1</sup>    | 1 × 10 <sup>3</sup>                                     | 1 × 10 <sup>6</sup>                           |
| Dy-166 (a)                   | 9 × 10 <sup>-1</sup>    | 3 × 10 <sup>-1</sup>    | 1 × 10 <sup>3</sup>                                     | 1 × 10 <sup>6</sup>                           |
| <b>Erbium (68)</b>           |                         |                         |   |   |
| Er-169                       | 4 × 10 <sup>1</sup>     | 1 × 10 <sup>0</sup>     | 1 × 10 <sup>4</sup>                                     | 1 × 10 <sup>7</sup>                           |
| Er-171                       | 8 × 10 <sup>-1</sup>    | 5 × 10 <sup>-1</sup>    | 1 × 10 <sup>2</sup>                                     | 1 × 10 <sup>6</sup>                           |
| <b>Europium (63)</b>         |                         |                         |   |   |
| Eu-147                       | 2 × 10 <sup>0</sup>     | 2 × 10 <sup>0</sup>     | 1 × 10 <sup>2</sup>                                     | 1 × 10 <sup>6</sup>                           |
| Eu-148                       | 5 × 10 <sup>-1</sup>    | 5 × 10 <sup>-1</sup>    | 1 × 10 <sup>1</sup>                                     | 1 × 10 <sup>6</sup>                           |
| Eu-149                       | 2 × 10 <sup>1</sup>     | 2 × 10 <sup>1</sup>     | 1 × 10 <sup>2</sup>                                     | 1 × 10 <sup>7</sup>                           |
| Eu-150 (short-lived)         | 2 × 10 <sup>0</sup>     | 7 × 10 <sup>-1</sup>    | 1 × 10 <sup>3</sup>                                     | 1 × 10 <sup>6</sup>                           |
| Eu-150 (long-lived)          | 7 × 10 <sup>-1</sup>    | 7 × 10 <sup>-1</sup>    | 1 × 10 <sup>1</sup>                                     | 1 × 10 <sup>6</sup>                           |
| Eu-152                       | 1 × 10 <sup>0</sup>     | 1 × 10 <sup>0</sup>     | 1 × 10 <sup>1</sup>                                     | 1 × 10 <sup>6</sup>                           |
| Eu-152m                      | 8 × 10 <sup>-1</sup>    | 8 × 10 <sup>-1</sup>    | 1 × 10 <sup>2</sup>                                     | 1 × 10 <sup>6</sup>                           |
| Eu-154                       | 9 × 10 <sup>-1</sup>    | 6 × 10 <sup>-1</sup>    | 1 × 10 <sup>1</sup>                                     | 1 × 10 <sup>6</sup>                           |



Part 2 – Classification

| Radionuclide (atomic number) | A <sub>1</sub><br>(TBq) | A <sub>2</sub><br>(TBq) | Activity concentration limit for exempt material (Bq/g) | Activity limit for an exempt consignment (Bq) |
|------------------------------|-------------------------|-------------------------|---|---|
| Eu-155                       | 2 × 10 <sup>1</sup>     | 3 × 10 <sup>0</sup>     | 1 × 10 <sup>2</sup>                                     | 1 × 10 <sup>7</sup>                           |
| Eu-156                       | 7 × 10 <sup>-1</sup>    | 7 × 10 <sup>-1</sup>    | 1 × 10 <sup>1</sup>                                     | 1 × 10 <sup>6</sup>                           |
| <b>Fluorine (9)</b>          |                         |                         |   |   |
| F-18                         | 1 × 10 <sup>0</sup>     | 6 × 10 <sup>-1</sup>    | 1 × 10 <sup>1</sup>                                     | 1 × 10 <sup>6</sup>                           |
| <b>Iron (26)</b>             |                         |                         |   |   |
| Fe-52 (a)                    | 3 × 10 <sup>-1</sup>    | 3 × 10 <sup>-1</sup>    | 1 × 10 <sup>1</sup>                                     | 1 × 10 <sup>6</sup>                           |
| Fe-55                        | 4 × 10 <sup>1</sup>     | 4 × 10 <sup>1</sup>     | 1 × 10 <sup>4</sup>                                     | 1 × 10 <sup>6</sup>                           |
| Fe-59                        | 9 × 10 <sup>-1</sup>    | 9 × 10 <sup>-1</sup>    | 1 × 10 <sup>1</sup>                                     | 1 × 10 <sup>6</sup>                           |
| Fe-60 (a)                    | 4 × 10 <sup>1</sup>     | 2 × 10 <sup>-1</sup>    | 1 × 10 <sup>2</sup>                                     | 1 × 10 <sup>5</sup>                           |
| <b>Gallium (31)</b>          |                         |                         |   |   |
| Ga-67                        | 7 × 10 <sup>0</sup>     | 3 × 10 <sup>0</sup>     | 1 × 10 <sup>2</sup>                                     | 1 × 10 <sup>6</sup>                           |
| Ga-68                        | 5 × 10 <sup>-1</sup>    | 5 × 10 <sup>-1</sup>    | 1 × 10 <sup>1</sup>                                     | 1 × 10 <sup>5</sup>                           |
| Ga-72                        | 4 × 10 <sup>-1</sup>    | 4 × 10 <sup>-1</sup>    | 1 × 10 <sup>1</sup>                                     | 1 × 10 <sup>5</sup>                           |
| <b>Gadolinium (64)</b>       |                         |                         |   |   |
| Gd-146 (a)                   | 5 × 10 <sup>-1</sup>    | 5 × 10 <sup>-1</sup>    | 1 × 10 <sup>1</sup>                                     | 1 × 10 <sup>6</sup>                           |
| Gd-148                       | 2 × 10 <sup>1</sup>     | 2 × 10 <sup>-3</sup>    | 1 × 10 <sup>1</sup>                                     | 1 × 10 <sup>4</sup>                           |
| Gd-153                       | 1 × 10 <sup>1</sup>     | 9 × 10 <sup>0</sup>     | 1 × 10 <sup>2</sup>                                     | 1 × 10 <sup>7</sup>                           |
| Gd-159                       | 3 × 10 <sup>0</sup>     | 6 × 10 <sup>-1</sup>    | 1 × 10 <sup>3</sup>                                     | 1 × 10 <sup>6</sup>                           |
| <b>Germanium (32)</b>        |                         |                         |   |   |
| Ge-68 (a)                    | 5 × 10 <sup>-1</sup>    | 5 × 10 <sup>-1</sup>    | 1 × 10 <sup>1</sup>                                     | 1 × 10 <sup>5</sup>                           |
| Ge-69                        | 1 × 10 <sup>0</sup>     | 1 × 10 <sup>0</sup>     | 1 × 10 <sup>1</sup>                                     | 1 × 10 <sup>6</sup>                           |
| Ge-71                        | 4 × 10 <sup>1</sup>     | 4 × 10 <sup>1</sup>     | 1 × 10 <sup>4</sup>                                     | 1 × 10 <sup>8</sup>                           |
| Ge-77                        | 3 × 10 <sup>-1</sup>    | 3 × 10 <sup>-1</sup>    | 1 × 10 <sup>1</sup>                                     | 1 × 10 <sup>5</sup>                           |
| <b>Hafnium (72)</b>          |                         |                         |   |   |
| Hf-172 (a)                   | 6 × 10 <sup>-1</sup>    | 6 × 10 <sup>-1</sup>    | 1 × 10 <sup>1</sup>                                     | 1 × 10 <sup>6</sup>                           |
| Hf-175                       | 3 × 10 <sup>0</sup>     | 3 × 10 <sup>0</sup>     | 1 × 10 <sup>2</sup>                                     | 1 × 10 <sup>6</sup>                           |
| Hf-181                       | 2 × 10 <sup>0</sup>     | 5 × 10 <sup>-1</sup>    | 1 × 10 <sup>1</sup>                                     | 1 × 10 <sup>6</sup>                           |
| Hf-182                       | Unlimited               | Unlimited               | 1 × 10 <sup>2</sup>                                     | 1 × 10 <sup>6</sup>                           |
| <b>Mercury (80)</b>          |                         |                         |   |   |
| Hg-194 (a)                   | 1 × 10 <sup>0</sup>     | 1 × 10 <sup>0</sup>     | 1 × 10 <sup>1</sup>                                     | 1 × 10 <sup>6</sup>                           |
| Hg-195m (a)                  | 3 × 10 <sup>0</sup>     | 7 × 10 <sup>-1</sup>    | 1 × 10 <sup>2</sup>                                     | 1 × 10 <sup>6</sup>                           |
| Hg-197                       | 2 × 10 <sup>1</sup>     | 1 × 10 <sup>1</sup>     | 1 × 10 <sup>2</sup>                                     | 1 × 10 <sup>7</sup>                           |
| Hg-197m                      | 1 × 10 <sup>1</sup>     | 4 × 10 <sup>-1</sup>    | 1 × 10 <sup>2</sup>                                     | 1 × 10 <sup>6</sup>                           |
| Hg-203                       | 5 × 10 <sup>0</sup>     | 1 × 10 <sup>0</sup>     | 1 × 10 <sup>2</sup>                                     | 1 × 10 <sup>5</sup>                           |
| <b>Holmium (67)</b>          |                         |                         |   |   |
| Ho-166                       | 4 × 10 <sup>-1</sup>    | 4 × 10 <sup>-1</sup>    | 1 × 10 <sup>3</sup>                                     | 1 × 10 <sup>5</sup>                           |
| Ho-166m                      | 6 × 10 <sup>-1</sup>    | 5 × 10 <sup>-1</sup>    | 1 × 10 <sup>1</sup>                                     | 1 × 10 <sup>6</sup>                           |
| <b>Iodine (53)</b>           |                         |                         |   |   |
| I-123                        | 6 × 10 <sup>0</sup>     | 3 × 10 <sup>0</sup>     | 1 × 10 <sup>2</sup>                                     | 1 × 10 <sup>7</sup>                           |
| I-124                        | 1 × 10 <sup>0</sup>     | 1 × 10 <sup>0</sup>     | 1 × 10 <sup>1</sup>                                     | 1 × 10 <sup>6</sup>                           |
| I-125                        | 2 × 10 <sup>1</sup>     | 3 × 10 <sup>0</sup>     | 1 × 10 <sup>3</sup>                                     | 1 × 10 <sup>6</sup>                           |
| I-126                        | 2 × 10 <sup>0</sup>     | 1 × 10 <sup>0</sup>     | 1 × 10 <sup>2</sup>                                     | 1 × 10 <sup>6</sup>                           |
| I-129                        | Unlimited               | Unlimited               | 1 × 10 <sup>2</sup>                                     | 1 × 10 <sup>5</sup>                           |
| I-131                        | 3 × 10 <sup>0</sup>     | 7 × 10 <sup>-1</sup>    | 1 × 10 <sup>2</sup>                                     | 1 × 10 <sup>6</sup>                           |
| I-132                        | 4 × 10 <sup>-1</sup>    | 4 × 10 <sup>-1</sup>    | 1 × 10 <sup>1</sup>                                     | 1 × 10 <sup>5</sup>                           |
| I-133                        | 7 × 10 <sup>-1</sup>    | 6 × 10 <sup>-1</sup>    | 1 × 10 <sup>1</sup>                                     | 1 × 10 <sup>6</sup>                           |
| I-134                        | 3 × 10 <sup>-1</sup>    | 3 × 10 <sup>-1</sup>    | 1 × 10 <sup>1</sup>                                     | 1 × 10 <sup>5</sup>                           |
| I-135 (a)                    | 6 × 10 <sup>-1</sup>    | 6 × 10 <sup>-1</sup>    | 1 × 10 <sup>1</sup>                                     | 1 × 10 <sup>6</sup>                           |
| <b>Indium (49)</b>           |                         |                         |   |   |
| In-111                       | 3 × 10 <sup>0</sup>     | 3 × 10 <sup>0</sup>     | 1 × 10 <sup>2</sup>                                     | 1 × 10 <sup>6</sup>                           |
| In-113m                      | 4 × 10 <sup>0</sup>     | 2 × 10 <sup>0</sup>     | 1 × 10 <sup>2</sup>                                     | 1 × 10 <sup>6</sup>                           |
| In-114m (a)                  | 1 × 10 <sup>1</sup>     | 5 × 10 <sup>-1</sup>    | 1 × 10 <sup>2</sup>                                     | 1 × 10 <sup>6</sup>                           |
| In-115m                      | 7 × 10 <sup>0</sup>     | 1 × 10 <sup>0</sup>     | 1 × 10 <sup>2</sup>                                     | 1 × 10 <sup>6</sup>                           |
| <b>Iridium (77)</b>          |                         |                         |   |   |
| Ir-189 (a)                   | 1 × 10 <sup>1</sup>     | 1 × 10 <sup>1</sup>     | 1 × 10 <sup>2</sup>                                     | 1 × 10 <sup>7</sup>                           |
| Ir-190                       | 7 × 10 <sup>-1</sup>    | 7 × 10 <sup>-1</sup>    | 1 × 10 <sup>1</sup>                                     | 1 × 10 <sup>6</sup>                           |
| Ir-192                       | 1 × 10 <sup>0</sup> (c) | 6 × 10 <sup>-1</sup>    | 1 × 10 <sup>1</sup>                                     | 1 × 10 <sup>4</sup>                           |
| Ir-193m                      | 4 × 10 <sup>1</sup>     | 4 × 10 <sup>0</sup>     | 1 × 10 <sup>4</sup>                                     | 1 × 10 <sup>7</sup>                           |
| Ir-194                       | 3 × 10 <sup>-1</sup>    | 3 × 10 <sup>-1</sup>    | 1 × 10 <sup>2</sup>                                     | 1 × 10 <sup>5</sup>                           |



| Radionuclide (atomic number) | A <sub>1</sub><br>(TBq) | A <sub>2</sub><br>(TBq) | Activity concentration limit for exempt material (Bq/g) | Activity limit for an exempt consignment (Bq) |
|------------------------------|-------------------------|-------------------------|---|---|
| <b>Potassium (19)</b>        |                         |                         |   |   |
| K-40                         | 9 × 10 <sup>-1</sup>    | 9 × 10 <sup>-1</sup>    | 1 × 10 <sup>2</sup>                                     | 1 × 10 <sup>6</sup>                           |
| K-42                         | 2 × 10 <sup>-1</sup>    | 2 × 10 <sup>-1</sup>    | 1 × 10 <sup>2</sup>                                     | 1 × 10 <sup>6</sup>                           |
| K-43                         | 7 × 10 <sup>-1</sup>    | 6 × 10 <sup>-1</sup>    | 1 × 10 <sup>1</sup>                                     | 1 × 10 <sup>6</sup>                           |
| <b>Krypton (36)</b>          |                         |                         |   |   |
| Kr-79                        | 4 × 10 <sup>0</sup>     | 2 × 10 <sup>0</sup>     | 1 × 10 <sup>3</sup>                                     | 1 × 10 <sup>5</sup>                           |
| Kr-81                        | 4 × 10 <sup>1</sup>     | 4 × 10 <sup>1</sup>     | 1 × 10 <sup>4</sup>                                     | 1 × 10 <sup>7</sup>                           |
| Kr-85                        | 1 × 10 <sup>1</sup>     | 1 × 10 <sup>1</sup>     | 1 × 10 <sup>5</sup>                                     | 1 × 10 <sup>4</sup>                           |
| Kr-85m                       | 8 × 10 <sup>0</sup>     | 3 × 10 <sup>0</sup>     | 1 × 10 <sup>3</sup>                                     | 1 × 10 <sup>10</sup>                          |
| Kr-87                        | 2 × 10 <sup>-1</sup>    | 2 × 10 <sup>-1</sup>    | 1 × 10 <sup>2</sup>                                     | 1 × 10 <sup>9</sup>                           |
| <b>Lanthanum (57)</b>        |                         |                         |   |   |
| La-137                       | 3 × 10 <sup>1</sup>     | 6 × 10 <sup>0</sup>     | 1 × 10 <sup>3</sup>                                     | 1 × 10 <sup>7</sup>                           |
| La-140                       | 4 × 10 <sup>-1</sup>    | 4 × 10 <sup>-1</sup>    | 1 × 10 <sup>1</sup>                                     | 1 × 10 <sup>5</sup>                           |
| <b>Lutetium (71)</b>         |                         |                         |   |   |
| Lu-172                       | 6 × 10 <sup>-1</sup>    | 6 × 10 <sup>-1</sup>    | 1 × 10 <sup>1</sup>                                     | 1 × 10 <sup>6</sup>                           |
| Lu-173                       | 8 × 10 <sup>0</sup>     | 8 × 10 <sup>0</sup>     | 1 × 10 <sup>2</sup>                                     | 1 × 10 <sup>7</sup>                           |
| Lu-174                       | 9 × 10 <sup>0</sup>     | 9 × 10 <sup>0</sup>     | 1 × 10 <sup>2</sup>                                     | 1 × 10 <sup>7</sup>                           |
| Lu-174m                      | 2 × 10 <sup>1</sup>     | 1 × 10 <sup>1</sup>     | 1 × 10 <sup>2</sup>                                     | 1 × 10 <sup>7</sup>                           |
| Lu-177                       | 3 × 10 <sup>1</sup>     | 7 × 10 <sup>-1</sup>    | 1 × 10 <sup>3</sup>                                     | 1 × 10 <sup>7</sup>                           |
| <b>Magnesium (12)</b>        |                         |                         |   |   |
| Mg-28 (a)                    | 3 × 10 <sup>-1</sup>    | 3 × 10 <sup>-1</sup>    | 1 × 10 <sup>1</sup>                                     | 1 × 10 <sup>5</sup>                           |
| <b>Manganese (25)</b>        |                         |                         |   |   |
| Mn-52                        | 3 × 10 <sup>-1</sup>    | 3 × 10 <sup>-1</sup>    | 1 × 10 <sup>1</sup>                                     | 1 × 10 <sup>5</sup>                           |
| Mn-53                        | Unlimited               | Unlimited               | 1 × 10 <sup>4</sup>                                     | 1 × 10 <sup>9</sup>                           |
| Mn-54                        | 1 × 10 <sup>0</sup>     | 1 × 10 <sup>0</sup>     | 1 × 10 <sup>1</sup>                                     | 1 × 10 <sup>6</sup>                           |
| Mn-56                        | 3 × 10 <sup>-1</sup>    | 3 × 10 <sup>-1</sup>    | 1 × 10 <sup>1</sup>                                     | 1 × 10 <sup>5</sup>                           |
| <b>Molybdenum (42)</b>       |                         |                         |   |   |
| Mo-93                        | 4 × 10 <sup>1</sup>     | 2 × 10 <sup>1</sup>     | 1 × 10 <sup>3</sup>                                     | 1 × 10 <sup>8</sup>                           |
| Mo-99 (a)                    | 1 × 10 <sup>0</sup>     | 6 × 10 <sup>-1</sup>    | 1 × 10 <sup>2</sup>                                     | 1 × 10 <sup>6</sup>                           |
| <b>Nitrogen (7)</b>          |                         |                         |   |   |
| N-13                         | 9 × 10 <sup>-1</sup>    | 6 × 10 <sup>-1</sup>    | 1 × 10 <sup>2</sup>                                     | 1 × 10 <sup>9</sup>                           |
| <b>Sodium (11)</b>           |                         |                         |   |   |
| Na-22                        | 5 × 10 <sup>-1</sup>    | 5 × 10 <sup>-1</sup>    | 1 × 10 <sup>1</sup>                                     | 1 × 10 <sup>6</sup>                           |
| Na-24                        | 2 × 10 <sup>-1</sup>    | 2 × 10 <sup>-1</sup>    | 1 × 10 <sup>1</sup>                                     | 1 × 10 <sup>5</sup>                           |
| <b>Niobium (41)</b>          |                         |                         |   |   |
| Nb-93m                       | 4 × 10 <sup>1</sup>     | 3 × 10 <sup>1</sup>     | 1 × 10 <sup>4</sup>                                     | 1 × 10 <sup>7</sup>                           |
| Nb-94                        | 7 × 10 <sup>-1</sup>    | 7 × 10 <sup>-1</sup>    | 1 × 10 <sup>1</sup>                                     | 1 × 10 <sup>6</sup>                           |
| Nb-95                        | 1 × 10 <sup>0</sup>     | 1 × 10 <sup>0</sup>     | 1 × 10 <sup>1</sup>                                     | 1 × 10 <sup>6</sup>                           |
| Nb-97                        | 9 × 10 <sup>-1</sup>    | 6 × 10 <sup>-1</sup>    | 1 × 10 <sup>1</sup>                                     | 1 × 10 <sup>6</sup>                           |
| <b>Neodymium (60)</b>        |                         |                         |   |   |
| Nd-147                       | 6 × 10 <sup>0</sup>     | 6 × 10 <sup>-1</sup>    | 1 × 10 <sup>2</sup>                                     | 1 × 10 <sup>6</sup>                           |
| Nd-149                       | 6 × 10 <sup>-1</sup>    | 5 × 10 <sup>-1</sup>    | 1 × 10 <sup>2</sup>                                     | 1 × 10 <sup>6</sup>                           |
| <b>Nickel (28)</b>           |                         |                         |   |   |
| Ni-57                        | 6 × 10 <sup>-1</sup>    | 6 × 10 <sup>-1</sup>    | 1 × 10 <sup>1</sup>                                     | 1 × 10 <sup>6</sup>                           |
| Ni-59                        | Unlimited               | Unlimited               | 1 × 10 <sup>4</sup>                                     | 1 × 10 <sup>8</sup>                           |
| Ni-63                        | 4 × 10 <sup>1</sup>     | 3 × 10 <sup>1</sup>     | 1 × 10 <sup>5</sup>                                     | 1 × 10 <sup>8</sup>                           |
| Ni-65                        | 4 × 10 <sup>-1</sup>    | 4 × 10 <sup>-1</sup>    | 1 × 10 <sup>1</sup>                                     | 1 × 10 <sup>6</sup>                           |
| <b>Neptunium (93)</b>        |                         |                         |   |   |
| Np-235                       | 4 × 10 <sup>1</sup>     | 4 × 10 <sup>1</sup>     | 1 × 10 <sup>3</sup>                                     | 1 × 10 <sup>7</sup>                           |
| Np-236 (short-lived)         | 2 × 10 <sup>1</sup>     | 2 × 10 <sup>0</sup>     | 1 × 10 <sup>3</sup>                                     | 1 × 10 <sup>7</sup>                           |
| Np-236 (long-lived)          | 9 × 10 <sup>0</sup>     | 2 × 10 <sup>-2</sup>    | 1 × 10 <sup>2</sup>                                     | 1 × 10 <sup>5</sup>                           |
| Np-237                       | 2 × 10 <sup>1</sup>     | 2 × 10 <sup>-3</sup>    | 1 × 10 <sup>0</sup> (b)                                 | 1 × 10 <sup>3</sup> (b)                       |
| Np-239                       | 7 × 10 <sup>0</sup>     | 4 × 10 <sup>-1</sup>    | 1 × 10 <sup>2</sup>                                     | 1 × 10 <sup>7</sup>                           |
| <b>Osmium (76)</b>           |                         |                         |   |   |
| Os-185                       | 1 × 10 <sup>0</sup>     | 1 × 10 <sup>0</sup>     | 1 × 10 <sup>1</sup>                                     | 1 × 10 <sup>6</sup>                           |
| Os-191                       | 1 × 10 <sup>1</sup>     | 2 × 10 <sup>0</sup>     | 1 × 10 <sup>2</sup>                                     | 1 × 10 <sup>7</sup>                           |
| Os-191m                      | 4 × 10 <sup>1</sup>     | 3 × 10 <sup>1</sup>     | 1 × 10 <sup>3</sup>                                     | 1 × 10 <sup>7</sup>                           |
| Os-193                       | 2 × 10 <sup>0</sup>     | 6 × 10 <sup>-1</sup>    | 1 × 10 <sup>2</sup>                                     | 1 × 10 <sup>6</sup>                           |

Part 2 – Classification

| Radionuclide (atomic number) | A <sub>1</sub><br>(TBq) | A <sub>2</sub><br>(TBq) | Activity concentration limit for exempt material (Bq/g) | Activity limit for an exempt consignment (Bq) |
|------------------------------|-------------------------|-------------------------|---|---|
| Os-194 (a)                   | 3 × 10 <sup>-1</sup>    | 3 × 10 <sup>-1</sup>    | 1 × 10 <sup>2</sup>                                     | 1 × 10 <sup>5</sup>                           |
| <b>Phosphorus (15)</b>       |                         |                         |   |   |
| P-32                         | 5 × 10 <sup>-1</sup>    | 5 × 10 <sup>-1</sup>    | 1 × 10 <sup>3</sup>                                     | 1 × 10 <sup>5</sup>                           |
| P-33                         | 4 × 10 <sup>1</sup>     | 1 × 10 <sup>0</sup>     | 1 × 10 <sup>5</sup>                                     | 1 × 10 <sup>8</sup>                           |
| <b>Protactinium (91)</b>     |                         |                         |   |   |
| Pa-230 (a)                   | 2 × 10 <sup>0</sup>     | 7 × 10 <sup>-2</sup>    | 1 × 10 <sup>1</sup>                                     | 1 × 10 <sup>6</sup>                           |
| Pa-231                       | 4 × 10 <sup>0</sup>     | 4 × 10 <sup>-4</sup>    | 1 × 10 <sup>0</sup>                                     | 1 × 10 <sup>3</sup>                           |
| Pa-233                       | 5 × 10 <sup>0</sup>     | 7 × 10 <sup>-1</sup>    | 1 × 10 <sup>2</sup>                                     | 1 × 10 <sup>7</sup>                           |
| <b>Lead (82)</b>             |                         |                         |   |   |
| Pb-201                       | 1 × 10 <sup>0</sup>     | 1 × 10 <sup>0</sup>     | 1 × 10 <sup>1</sup>                                     | 1 × 10 <sup>6</sup>                           |
| Pb-202                       | 4 × 10 <sup>1</sup>     | 2 × 10 <sup>1</sup>     | 1 × 10 <sup>3</sup>                                     | 1 × 10 <sup>6</sup>                           |
| Pb-203                       | 4 × 10 <sup>0</sup>     | 3 × 10 <sup>0</sup>     | 1 × 10 <sup>2</sup>                                     | 1 × 10 <sup>6</sup>                           |
| Pb-205                       | Unlimited               | Unlimited               | 1 × 10 <sup>4</sup>                                     | 1 × 10 <sup>7</sup>                           |
| Pb-210 (a)                   | 1 × 10 <sup>0</sup>     | 5 × 10 <sup>-2</sup>    | 1 × 10 <sup>1</sup> (b)                                 | 1 × 10 <sup>4</sup> (b)                       |
| Pb-212 (a)                   | 7 × 10 <sup>-1</sup>    | 2 × 10 <sup>-1</sup>    | 1 × 10 <sup>1</sup> (b)                                 | 1 × 10 <sup>5</sup> (b)                       |
| <b>Palladium (46)</b>        |                         |                         |   |   |
| Pd-103 (a)                   | 4 × 10 <sup>1</sup>     | 4 × 10 <sup>1</sup>     | 1 × 10 <sup>3</sup>                                     | 1 × 10 <sup>8</sup>                           |
| Pd-107                       | Unlimited               | Unlimited               | 1 × 10 <sup>5</sup>                                     | 1 × 10 <sup>8</sup>                           |
| Pd-109                       | 2 × 10 <sup>0</sup>     | 5 × 10 <sup>-1</sup>    | 1 × 10 <sup>3</sup>                                     | 1 × 10 <sup>6</sup>                           |
| <b>Promethium (61)</b>       |                         |                         |   |   |
| Pm-143                       | 3 × 10 <sup>0</sup>     | 3 × 10 <sup>0</sup>     | 1 × 10 <sup>2</sup>                                     | 1 × 10 <sup>6</sup>                           |
| Pm-144                       | 7 × 10 <sup>-1</sup>    | 7 × 10 <sup>-1</sup>    | 1 × 10 <sup>1</sup>                                     | 1 × 10 <sup>6</sup>                           |
| Pm-145                       | 3 × 10 <sup>1</sup>     | 1 × 10 <sup>1</sup>     | 1 × 10 <sup>3</sup>                                     | 1 × 10 <sup>7</sup>                           |
| Pm-147                       | 4 × 10 <sup>1</sup>     | 2 × 10 <sup>0</sup>     | 1 × 10 <sup>4</sup>                                     | 1 × 10 <sup>7</sup>                           |
| Pm-148m (a)                  | 8 × 10 <sup>-1</sup>    | 7 × 10 <sup>-1</sup>    | 1 × 10 <sup>1</sup>                                     | 1 × 10 <sup>6</sup>                           |
| Pm-149                       | 2 × 10 <sup>0</sup>     | 6 × 10 <sup>-1</sup>    | 1 × 10 <sup>3</sup>                                     | 1 × 10 <sup>6</sup>                           |
| Pm-151                       | 2 × 10 <sup>0</sup>     | 6 × 10 <sup>-1</sup>    | 1 × 10 <sup>2</sup>                                     | 1 × 10 <sup>6</sup>                           |
| <b>Polonium (84)</b>         |                         |                         |   |   |
| Po-210                       | 4 × 10 <sup>1</sup>     | 2 × 10 <sup>-2</sup>    | 1 × 10 <sup>1</sup>                                     | 1 × 10 <sup>4</sup>                           |
| <b>Praseodymium (59)</b>     |                         |                         |   |   |
| Pr-142                       | 4 × 10 <sup>-1</sup>    | 4 × 10 <sup>-1</sup>    | 1 × 10 <sup>2</sup>                                     | 1 × 10 <sup>5</sup>                           |
| Pr-143                       | 3 × 10 <sup>0</sup>     | 6 × 10 <sup>-1</sup>    | 1 × 10 <sup>4</sup>                                     | 1 × 10 <sup>6</sup>                           |
| <b>Platinum (78)</b>         |                         |                         |   |   |
| Pt-188 (a)                   | 1 × 10 <sup>0</sup>     | 8 × 10 <sup>-1</sup>    | 1 × 10 <sup>1</sup>                                     | 1 × 10 <sup>6</sup>                           |
| Pt-191                       | 4 × 10 <sup>0</sup>     | 3 × 10 <sup>0</sup>     | 1 × 10 <sup>2</sup>                                     | 1 × 10 <sup>6</sup>                           |
| Pt-193                       | 4 × 10 <sup>1</sup>     | 4 × 10 <sup>1</sup>     | 1 × 10 <sup>4</sup>                                     | 1 × 10 <sup>7</sup>                           |
| Pt-193m                      | 4 × 10 <sup>1</sup>     | 5 × 10 <sup>-1</sup>    | 1 × 10 <sup>3</sup>                                     | 1 × 10 <sup>7</sup>                           |
| Pt-195m                      | 1 × 10 <sup>1</sup>     | 5 × 10 <sup>-1</sup>    | 1 × 10 <sup>2</sup>                                     | 1 × 10 <sup>6</sup>                           |
| Pt-197                       | 2 × 10 <sup>1</sup>     | 6 × 10 <sup>-1</sup>    | 1 × 10 <sup>3</sup>                                     | 1 × 10 <sup>6</sup>                           |
| Pt-197m                      | 1 × 10 <sup>1</sup>     | 6 × 10 <sup>-1</sup>    | 1 × 10 <sup>2</sup>                                     | 1 × 10 <sup>6</sup>                           |
| <b>Plutonium (94)</b>        |                         |                         |   |   |
| Pu-236                       | 3 × 10 <sup>1</sup>     | 3 × 10 <sup>-3</sup>    | 1 × 10 <sup>1</sup>                                     | 1 × 10 <sup>4</sup>                           |
| Pu-237                       | 2 × 10 <sup>1</sup>     | 2 × 10 <sup>1</sup>     | 1 × 10 <sup>3</sup>                                     | 1 × 10 <sup>7</sup>                           |
| Pu-238                       | 1 × 10 <sup>1</sup>     | 1 × 10 <sup>-3</sup>    | 1 × 10 <sup>0</sup>                                     | 1 × 10 <sup>4</sup>                           |
| Pu-239                       | 1 × 10 <sup>1</sup>     | 1 × 10 <sup>-3</sup>    | 1 × 10 <sup>0</sup>                                     | 1 × 10 <sup>4</sup>                           |
| Pu-240                       | 1 × 10 <sup>1</sup>     | 1 × 10 <sup>-3</sup>    | 1 × 10 <sup>0</sup>                                     | 1 × 10 <sup>3</sup>                           |
| Pu-241 (a)                   | 4 × 10 <sup>1</sup>     | 6 × 10 <sup>-2</sup>    | 1 × 10 <sup>2</sup>                                     | 1 × 10 <sup>5</sup>                           |
| Pu-242                       | 1 × 10 <sup>1</sup>     | 1 × 10 <sup>-3</sup>    | 1 × 10 <sup>0</sup>                                     | 1 × 10 <sup>4</sup>                           |
| Pu-244 (a)                   | 4 × 10 <sup>-1</sup>    | 1 × 10 <sup>-3</sup>    | 1 × 10 <sup>0</sup>                                     | 1 × 10 <sup>4</sup>                           |
| <b>Radium (88)</b>           |                         |                         |   |   |
| Ra-223 (a)                   | 4 × 10 <sup>-1</sup>    | 7 × 10 <sup>-3</sup>    | 1 × 10 <sup>2</sup> (b)                                 | 1 × 10 <sup>5</sup> (b)                       |
| Ra-224 (a)                   | 4 × 10 <sup>-1</sup>    | 2 × 10 <sup>-2</sup>    | 1 × 10 <sup>1</sup> (b)                                 | 1 × 10 <sup>5</sup> (b)                       |
| Ra-225 (a)                   | 2 × 10 <sup>-1</sup>    | 4 × 10 <sup>-3</sup>    | 1 × 10 <sup>2</sup>                                     | 1 × 10 <sup>5</sup>                           |
| Ra-226 (a)                   | 2 × 10 <sup>-1</sup>    | 3 × 10 <sup>-3</sup>    | 1 × 10 <sup>1</sup> (b)                                 | 1 × 10 <sup>4</sup> (b)                       |
| Ra-228 (a)                   | 6 × 10 <sup>-1</sup>    | 2 × 10 <sup>-2</sup>    | 1 × 10 <sup>1</sup> (b)                                 | 1 × 10 <sup>5</sup> (b)                       |
| <b>Rubidium (37)</b>         |                         |                         |   |   |
| Rb-81                        | 2 × 10 <sup>0</sup>     | 8 × 10 <sup>-1</sup>    | 1 × 10 <sup>1</sup>                                     | 1 × 10 <sup>6</sup>                           |
| Rb-83 (a)                    | 2 × 10 <sup>0</sup>     | 2 × 10 <sup>0</sup>     | 1 × 10 <sup>2</sup>                                     | 1 × 10 <sup>6</sup>                           |



| Radionuclide (atomic number) | A <sub>1</sub><br>(TBq) | A <sub>2</sub><br>(TBq) | Activity concentration limit for exempt material (Bq/g) | Activity limit for an exempt consignment (Bq) |
|------------------------------|-------------------------|-------------------------|---|---|
| Rb-84                        | 1 × 10 <sup>0</sup>     | 1 × 10 <sup>0</sup>     | 1 × 10 <sup>1</sup>                                     | 1 × 10 <sup>6</sup>                           |
| Rb-86                        | 5 × 10 <sup>-1</sup>    | 5 × 10 <sup>-1</sup>    | 1 × 10 <sup>2</sup>                                     | 1 × 10 <sup>5</sup>                           |
| Rb-87                        | Unlimited               | Unlimited               | 1 × 10 <sup>4</sup>                                     | 1 × 10 <sup>7</sup>                           |
| Rb (nat)                     | Unlimited               | Unlimited               | 1 × 10 <sup>4</sup>                                     | 1 × 10 <sup>7</sup>                           |
| <b>Rhenium (75)</b>          |                         |                         |   |   |
| Re-184                       | 1 × 10 <sup>0</sup>     | 1 × 10 <sup>0</sup>     | 1 × 10 <sup>1</sup>                                     | 1 × 10 <sup>6</sup>                           |
| Re-184m                      | 3 × 10 <sup>0</sup>     | 1 × 10 <sup>0</sup>     | 1 × 10 <sup>2</sup>                                     | 1 × 10 <sup>6</sup>                           |
| Re-186                       | 2 × 10 <sup>0</sup>     | 6 × 10 <sup>-1</sup>    | 1 × 10 <sup>3</sup>                                     | 1 × 10 <sup>6</sup>                           |
| Re-187                       | Unlimited               | Unlimited               | 1 × 10 <sup>6</sup>                                     | 1 × 10 <sup>9</sup>                           |
| Re-188                       | 4 × 10 <sup>-1</sup>    | 4 × 10 <sup>-1</sup>    | 1 × 10 <sup>2</sup>                                     | 1 × 10 <sup>5</sup>                           |
| Re-189 (a)                   | 3 × 10 <sup>0</sup>     | 6 × 10 <sup>-1</sup>    | 1 × 10 <sup>2</sup>                                     | 1 × 10 <sup>6</sup>                           |
| Re (nat)                     | Unlimited               | Unlimited               | 1 × 10 <sup>6</sup>                                     | 1 × 10 <sup>9</sup>                           |
| <b>Rhodium (45)</b>          |                         |                         |   |   |
| Rh-99                        | 2 × 10 <sup>0</sup>     | 2 × 10 <sup>0</sup>     | 1 × 10 <sup>1</sup>                                     | 1 × 10 <sup>6</sup>                           |
| Rh-101                       | 4 × 10 <sup>0</sup>     | 3 × 10 <sup>0</sup>     | 1 × 10 <sup>2</sup>                                     | 1 × 10 <sup>7</sup>                           |
| Rh-102                       | 5 × 10 <sup>-1</sup>    | 5 × 10 <sup>-1</sup>    | 1 × 10 <sup>1</sup>                                     | 1 × 10 <sup>6</sup>                           |
| Rh-102m                      | 2 × 10 <sup>0</sup>     | 2 × 10 <sup>0</sup>     | 1 × 10 <sup>2</sup>                                     | 1 × 10 <sup>6</sup>                           |
| Rh-103m                      | 4 × 10 <sup>1</sup>     | 4 × 10 <sup>1</sup>     | 1 × 10 <sup>4</sup>                                     | 1 × 10 <sup>8</sup>                           |
| Rh-105                       | 1 × 10 <sup>1</sup>     | 8 × 10 <sup>-1</sup>    | 1 × 10 <sup>2</sup>                                     | 1 × 10 <sup>7</sup>                           |
| <b>Radon (86)</b>            |                         |                         |   |   |
| Rn-222 (a)                   | 3 × 10 <sup>-1</sup>    | 4 × 10 <sup>-3</sup>    | 1 × 10 <sup>1</sup> (b)                                 | 1 × 10 <sup>8</sup> (b)                       |
| <b>Ruthenium (44)</b>        |                         |                         |   |   |
| Ru-97                        | 5 × 10 <sup>0</sup>     | 5 × 10 <sup>0</sup>     | 1 × 10 <sup>2</sup>                                     | 1 × 10 <sup>7</sup>                           |
| Ru-103 (a)                   | 2 × 10 <sup>0</sup>     | 2 × 10 <sup>0</sup>     | 1 × 10 <sup>2</sup>                                     | 1 × 10 <sup>6</sup>                           |
| Ru-105                       | 1 × 10 <sup>0</sup>     | 6 × 10 <sup>-1</sup>    | 1 × 10 <sup>1</sup>                                     | 1 × 10 <sup>6</sup>                           |
| Ru-106 (a)                   | 2 × 10 <sup>-1</sup>    | 2 × 10 <sup>-1</sup>    | 1 × 10 <sup>2</sup> (b)                                 | 1 × 10 <sup>5</sup> (b)                       |
| <b>Sulphur (16)</b>          |                         |                         |   |   |
| S-35                         | 4 × 10 <sup>1</sup>     | 3 × 10 <sup>0</sup>     | 1 × 10 <sup>5</sup>                                     | 1 × 10 <sup>8</sup>                           |
| <b>Antimony (51)</b>         |                         |                         |   |   |
| Sb-122                       | 4 × 10 <sup>-1</sup>    | 4 × 10 <sup>-1</sup>    | 1 × 10 <sup>2</sup>                                     | 1 × 10 <sup>4</sup>                           |
| Sb-124                       | 6 × 10 <sup>-1</sup>    | 6 × 10 <sup>-1</sup>    | 1 × 10 <sup>1</sup>                                     | 1 × 10 <sup>6</sup>                           |
| Sb-125                       | 2 × 10 <sup>0</sup>     | 1 × 10 <sup>0</sup>     | 1 × 10 <sup>2</sup>                                     | 1 × 10 <sup>6</sup>                           |
| Sb-126                       | 4 × 10 <sup>-1</sup>    | 4 × 10 <sup>-1</sup>    | 1 × 10 <sup>1</sup>                                     | 1 × 10 <sup>5</sup>                           |
| <b>Scandium (21)</b>         |                         |                         |   |   |
| Sc-44                        | 5 × 10 <sup>-1</sup>    | 5 × 10 <sup>-1</sup>    | 1 × 10 <sup>1</sup>                                     | 1 × 10 <sup>5</sup>                           |
| Sc-46                        | 5 × 10 <sup>-1</sup>    | 5 × 10 <sup>-1</sup>    | 1 × 10 <sup>1</sup>                                     | 1 × 10 <sup>6</sup>                           |
| Sc-47                        | 1 × 10 <sup>1</sup>     | 7 × 10 <sup>-1</sup>    | 1 × 10 <sup>2</sup>                                     | 1 × 10 <sup>6</sup>                           |
| Sc-48                        | 3 × 10 <sup>-1</sup>    | 3 × 10 <sup>-1</sup>    | 1 × 10 <sup>1</sup>                                     | 1 × 10 <sup>5</sup>                           |
| <b>Selenium (34)</b>         |                         |                         |   |   |
| Se-75                        | 3 × 10 <sup>0</sup>     | 3 × 10 <sup>0</sup>     | 1 × 10 <sup>2</sup>                                     | 1 × 10 <sup>6</sup>                           |
| Se-79                        | 4 × 10 <sup>1</sup>     | 2 × 10 <sup>0</sup>     | 1 × 10 <sup>4</sup>                                     | 1 × 10 <sup>7</sup>                           |
| <b>Silicon (14)</b>          |                         |                         |   |   |
| Si-31                        | 6 × 10 <sup>-1</sup>    | 6 × 10 <sup>-1</sup>    | 1 × 10 <sup>3</sup>                                     | 1 × 10 <sup>6</sup>                           |
| Si-32                        | 4 × 10 <sup>1</sup>     | 5 × 10 <sup>-1</sup>    | 1 × 10 <sup>3</sup>                                     | 1 × 10 <sup>6</sup>                           |
| <b>Samarium (62)</b>         |                         |                         |   |   |
| Sm-145                       | 1 × 10 <sup>1</sup>     | 1 × 10 <sup>1</sup>     | 1 × 10 <sup>2</sup>                                     | 1 × 10 <sup>7</sup>                           |
| Sm-147                       | Unlimited               | Unlimited               | 1 × 10 <sup>1</sup>                                     | 1 × 10 <sup>4</sup>                           |
| Sm-151                       | 4 × 10 <sup>1</sup>     | 1 × 10 <sup>1</sup>     | 1 × 10 <sup>4</sup>                                     | 1 × 10 <sup>8</sup>                           |
| Sm-153                       | 9 × 10 <sup>0</sup>     | 6 × 10 <sup>-1</sup>    | 1 × 10 <sup>2</sup>                                     | 1 × 10 <sup>6</sup>                           |
| <b>Tin (50)</b>              |                         |                         |   |   |
| Sn-113 (a)                   | 4 × 10 <sup>0</sup>     | 2 × 10 <sup>0</sup>     | 1 × 10 <sup>3</sup>                                     | 1 × 10 <sup>7</sup>                           |
| Sn-117m                      | 7 × 10 <sup>0</sup>     | 4 × 10 <sup>-1</sup>    | 1 × 10 <sup>2</sup>                                     | 1 × 10 <sup>6</sup>                           |
| Sn-119m                      | 4 × 10 <sup>1</sup>     | 3 × 10 <sup>1</sup>     | 1 × 10 <sup>3</sup>                                     | 1 × 10 <sup>7</sup>                           |
| Sn-121m (a)                  | 4 × 10 <sup>1</sup>     | 9 × 10 <sup>-1</sup>    | 1 × 10 <sup>3</sup>                                     | 1 × 10 <sup>7</sup>                           |
| Sn-123                       | 8 × 10 <sup>-1</sup>    | 6 × 10 <sup>-1</sup>    | 1 × 10 <sup>3</sup>                                     | 1 × 10 <sup>6</sup>                           |
| Sn-125                       | 4 × 10 <sup>-1</sup>    | 4 × 10 <sup>-1</sup>    | 1 × 10 <sup>2</sup>                                     | 1 × 10 <sup>5</sup>                           |
| Sn-126 (a)                   | 6 × 10 <sup>-1</sup>    | 4 × 10 <sup>-1</sup>    | 1 × 10 <sup>1</sup>                                     | 1 × 10 <sup>5</sup>                           |

Part 2 – Classification

| Radionuclide (atomic number) | A <sub>1</sub><br>(TBq) | A <sub>2</sub><br>(TBq) | Activity concentration limit for exempt material (Bq/g) | Activity limit for an exempt consignment (Bq) |
|------------------------------|-------------------------|-------------------------|---|---|
| <b>Strontium (38)</b>        |                         |                         |   |   |
| Sr-82 (a)                    | 2 × 10 <sup>-1</sup>    | 2 × 10 <sup>-1</sup>    | 1 × 10 <sup>1</sup>                                     | 1 × 10 <sup>5</sup>                           |
| Sr-83                        | 1 × 10 <sup>0</sup>     | 1 × 10 <sup>0</sup>     | 1 × 10 <sup>1</sup>                                     | 1 × 10 <sup>6</sup>                           |
| Sr-85                        | 2 × 10 <sup>0</sup>     | 2 × 10 <sup>0</sup>     | 1 × 10 <sup>2</sup>                                     | 1 × 10 <sup>6</sup>                           |
| Sr-85m                       | 5 × 10 <sup>0</sup>     | 5 × 10 <sup>0</sup>     | 1 × 10 <sup>2</sup>                                     | 1 × 10 <sup>7</sup>                           |
| Sr-87m                       | 3 × 10 <sup>0</sup>     | 3 × 10 <sup>0</sup>     | 1 × 10 <sup>2</sup>                                     | 1 × 10 <sup>6</sup>                           |
| Sr-89                        | 6 × 10 <sup>-1</sup>    | 6 × 10 <sup>-1</sup>    | 1 × 10 <sup>3</sup>                                     | 1 × 10 <sup>6</sup>                           |
| Sr-90 (a)                    | 3 × 10 <sup>-1</sup>    | 3 × 10 <sup>-1</sup>    | 1 × 10 <sup>2</sup> (b)                                 | 1 × 10 <sup>4</sup> (b)                       |
| Sr-91 (a)                    | 3 × 10 <sup>-1</sup>    | 3 × 10 <sup>-1</sup>    | 1 × 10 <sup>1</sup>                                     | 1 × 10 <sup>5</sup>                           |
| Sr-92 (a)                    | 1 × 10 <sup>0</sup>     | 3 × 10 <sup>-1</sup>    | 1 × 10 <sup>1</sup>                                     | 1 × 10 <sup>6</sup>                           |
| <b>Tritium (1)</b>           |                         |                         |   |   |
| T (H-3)                      | 4 × 10 <sup>1</sup>     | 4 × 10 <sup>1</sup>     | 1 × 10 <sup>6</sup>                                     | 1 × 10 <sup>9</sup>                           |
| <b>Tantalum (73)</b>         |                         |                         |   |   |
| Ta-178 (long-lived)          | 1 × 10 <sup>0</sup>     | 8 × 10 <sup>-1</sup>    | 1 × 10 <sup>1</sup>                                     | 1 × 10 <sup>6</sup>                           |
| Ta-179                       | 3 × 10 <sup>1</sup>     | 3 × 10 <sup>1</sup>     | 1 × 10 <sup>3</sup>                                     | 1 × 10 <sup>7</sup>                           |
| Ta-182                       | 9 × 10 <sup>-1</sup>    | 5 × 10 <sup>-1</sup>    | 1 × 10 <sup>1</sup>                                     | 1 × 10 <sup>4</sup>                           |
| <b>Terbium (65)</b>          |                         |                         |   |   |
| Tb-149                       | 8 × 10 <sup>-1</sup>    | 8 × 10 <sup>-1</sup>    | 1 × 10 <sup>1</sup>                                     | 1 × 10 <sup>6</sup>                           |
| Tb-157                       | 4 × 10 <sup>1</sup>     | 4 × 10 <sup>1</sup>     | 1 × 10 <sup>4</sup>                                     | 1 × 10 <sup>7</sup>                           |
| Tb-158                       | 1 × 10 <sup>0</sup>     | 1 × 10 <sup>0</sup>     | 1 × 10 <sup>1</sup>                                     | 1 × 10 <sup>6</sup>                           |
| Tb-160                       | 1 × 10 <sup>0</sup>     | 6 × 10 <sup>-1</sup>    | 1 × 10 <sup>1</sup>                                     | 1 × 10 <sup>6</sup>                           |
| Tb-161                       | 3 × 10 <sup>1</sup>     | 7 × 10 <sup>-1</sup>    | 1 × 10 <sup>3</sup>                                     | 1 × 10 <sup>6</sup>                           |
| <b>Technetium (43)</b>       |                         |                         |   |   |
| Tc-95m (a)                   | 2 × 10 <sup>0</sup>     | 2 × 10 <sup>0</sup>     | 1 × 10 <sup>1</sup>                                     | 1 × 10 <sup>6</sup>                           |
| Tc-96                        | 4 × 10 <sup>-1</sup>    | 4 × 10 <sup>-1</sup>    | 1 × 10 <sup>1</sup>                                     | 1 × 10 <sup>6</sup>                           |
| Tc-96m (a)                   | 4 × 10 <sup>-1</sup>    | 4 × 10 <sup>-1</sup>    | 1 × 10 <sup>3</sup>                                     | 1 × 10 <sup>7</sup>                           |
| Tc-97                        | Unlimited               | Unlimited               | 1 × 10 <sup>3</sup>                                     | 1 × 10 <sup>8</sup>                           |
| Tc-97m                       | 4 × 10 <sup>1</sup>     | 1 × 10 <sup>0</sup>     | 1 × 10 <sup>3</sup>                                     | 1 × 10 <sup>7</sup>                           |
| Tc-98                        | 8 × 10 <sup>-1</sup>    | 7 × 10 <sup>-1</sup>    | 1 × 10 <sup>1</sup>                                     | 1 × 10 <sup>6</sup>                           |
| Tc-99                        | 4 × 10 <sup>1</sup>     | 9 × 10 <sup>-1</sup>    | 1 × 10 <sup>4</sup>                                     | 1 × 10 <sup>7</sup>                           |
| Tc-99m                       | 1 × 10 <sup>1</sup>     | 4 × 10 <sup>0</sup>     | 1 × 10 <sup>2</sup>                                     | 1 × 10 <sup>7</sup>                           |
| <b>Tellurium (52)</b>        |                         |                         |   |   |
| Te-121                       | 2 × 10 <sup>0</sup>     | 2 × 10 <sup>0</sup>     | 1 × 10 <sup>1</sup>                                     | 1 × 10 <sup>6</sup>                           |
| Te-121m                      | 5 × 10 <sup>0</sup>     | 3 × 10 <sup>0</sup>     | 1 × 10 <sup>2</sup>                                     | 1 × 10 <sup>6</sup>                           |
| Te-123m                      | 8 × 10 <sup>0</sup>     | 1 × 10 <sup>0</sup>     | 1 × 10 <sup>2</sup>                                     | 1 × 10 <sup>7</sup>                           |
| Te-125m                      | 2 × 10 <sup>1</sup>     | 9 × 10 <sup>-1</sup>    | 1 × 10 <sup>3</sup>                                     | 1 × 10 <sup>7</sup>                           |
| Te-127                       | 2 × 10 <sup>1</sup>     | 7 × 10 <sup>-1</sup>    | 1 × 10 <sup>3</sup>                                     | 1 × 10 <sup>6</sup>                           |
| Te-127m (a)                  | 2 × 10 <sup>1</sup>     | 5 × 10 <sup>-1</sup>    | 1 × 10 <sup>3</sup>                                     | 1 × 10 <sup>7</sup>                           |
| Te-129                       | 7 × 10 <sup>-1</sup>    | 6 × 10 <sup>-1</sup>    | 1 × 10 <sup>2</sup>                                     | 1 × 10 <sup>6</sup>                           |
| Te-129m (a)                  | 8 × 10 <sup>-1</sup>    | 4 × 10 <sup>-1</sup>    | 1 × 10 <sup>3</sup>                                     | 1 × 10 <sup>6</sup>                           |
| Te-131m (a)                  | 7 × 10 <sup>-1</sup>    | 5 × 10 <sup>-1</sup>    | 1 × 10 <sup>1</sup>                                     | 1 × 10 <sup>6</sup>                           |
| Te-132 (a)                   | 5 × 10 <sup>-1</sup>    | 4 × 10 <sup>-1</sup>    | 1 × 10 <sup>2</sup>                                     | 1 × 10 <sup>7</sup>                           |
| <b>Thorium (90)</b>          |                         |                         |   |   |
| Th-227                       | 1 × 10 <sup>1</sup>     | 5 × 10 <sup>-3</sup>    | 1 × 10 <sup>1</sup>                                     | 1 × 10 <sup>4</sup>                           |
| Th-228 (a)                   | 5 × 10 <sup>-1</sup>    | 1 × 10 <sup>-3</sup>    | 1 × 10 <sup>0</sup> (b)                                 | 1 × 10 <sup>4</sup> (b)                       |
| Th-229                       | 5 × 10 <sup>0</sup>     | 5 × 10 <sup>-4</sup>    | 1 × 10 <sup>0</sup> (b)                                 | 1 × 10 <sup>3</sup> (b)                       |
| Th-230                       | 1 × 10 <sup>1</sup>     | 1 × 10 <sup>-3</sup>    | 1 × 10 <sup>0</sup>                                     | 1 × 10 <sup>4</sup>                           |
| Th-231                       | 4 × 10 <sup>1</sup>     | 2 × 10 <sup>-2</sup>    | 1 × 10 <sup>3</sup>                                     | 1 × 10 <sup>7</sup>                           |
| Th-232                       | Unlimited               | Unlimited               | 1 × 10 <sup>1</sup>                                     | 1 × 10 <sup>4</sup>                           |
| Th-234 (a)                   | 3 × 10 <sup>-1</sup>    | 3 × 10 <sup>-1</sup>    | 1 × 10 <sup>3</sup> (b)                                 | 1 × 10 <sup>5</sup> (b)                       |
| Th (nat)                     | Unlimited               | Unlimited               | 1 × 10 <sup>0</sup> (b)                                 | 1 × 10 <sup>3</sup> (b)                       |
| <b>Titanium (22)</b>         |                         |                         |   |   |
| Ti-44 (a)                    | 5 × 10 <sup>-1</sup>    | 4 × 10 <sup>-1</sup>    | 1 × 10 <sup>1</sup>                                     | 1 × 10 <sup>5</sup>                           |
| <b>Thallium (81)</b>         |                         |                         |   |   |
| Tl-200                       | 9 × 10 <sup>-1</sup>    | 9 × 10 <sup>-1</sup>    | 1 × 10 <sup>1</sup>                                     | 1 × 10 <sup>6</sup>                           |
| Tl-201                       | 1 × 10 <sup>1</sup>     | 4 × 10 <sup>0</sup>     | 1 × 10 <sup>2</sup>                                     | 1 × 10 <sup>6</sup>                           |
| Tl-202                       | 2 × 10 <sup>0</sup>     | 2 × 10 <sup>0</sup>     | 1 × 10 <sup>2</sup>                                     | 1 × 10 <sup>6</sup>                           |
| Tl-204                       | 1 × 10 <sup>1</sup>     | 7 × 10 <sup>-1</sup>    | 1 × 10 <sup>4</sup>                                     | 1 × 10 <sup>4</sup>                           |



| Radionuclide (atomic number)                      | A <sub>1</sub><br>(TBq) | A <sub>2</sub><br>(TBq) | Activity concentration limit for exempt material (Bq/g) | Activity limit for an exempt consignment (Bq) |
|---|-------------------------|-------------------------|---|---|
| <b>Thulium (69)</b>                               |                         |                         |   |   |
| Tm-167  | 7 × 10 <sup>0</sup>     | 8 × 10 <sup>-1</sup>    | 1 × 10 <sup>2</sup>                                     | 1 × 10 <sup>6</sup>                           |
| Tm-170  | 3 × 10 <sup>0</sup>     | 6 × 10 <sup>-1</sup>    | 1 × 10 <sup>3</sup>                                     | 1 × 10 <sup>6</sup>                           |
| Tm-171  | 4 × 10 <sup>1</sup>     | 4 × 10 <sup>1</sup>     | 1 × 10 <sup>4</sup>                                     | 1 × 10 <sup>8</sup>                           |
| <b>Uranium (92)</b>                               |                         |                         |   |   |
| U-230 (fast lung absorption) (a) (d)              | 4 × 10 <sup>1</sup>     | 1 × 10 <sup>-1</sup>    | 1 × 10 <sup>1</sup> (b)                                 | 1 × 10 <sup>5</sup> (b)                       |
| U-230 (medium lung absorption) (a) (e)            | 4 × 10 <sup>1</sup>     | 4 × 10 <sup>-3</sup>    | 1 × 10 <sup>1</sup>                                     | 1 × 10 <sup>4</sup>                           |
| U-230 (slow lung absorption) (a) (f)              | 3 × 10 <sup>1</sup>     | 3 × 10 <sup>-3</sup>    | 1 × 10 <sup>1</sup>                                     | 1 × 10 <sup>4</sup>                           |
| U-232 (fast lung absorption) (d)                  | 4 × 10 <sup>1</sup>     | 1 × 10 <sup>-2</sup>    | 1 × 10 <sup>0</sup> (b)                                 | 1 × 10 <sup>3</sup> (b)                       |
| U-232 (medium lung absorption) (e)                | 4 × 10 <sup>1</sup>     | 7 × 10 <sup>-3</sup>    | 1 × 10 <sup>1</sup>                                     | 1 × 10 <sup>4</sup>                           |
| U-232 (slow lung absorption) (f)                  | 1 × 10 <sup>1</sup>     | 1 × 10 <sup>-3</sup>    | 1 × 10 <sup>1</sup>                                     | 1 × 10 <sup>4</sup>                           |
| U-233 (fast lung absorption) (d)                  | 4 × 10 <sup>1</sup>     | 9 × 10 <sup>-2</sup>    | 1 × 10 <sup>1</sup>                                     | 1 × 10 <sup>4</sup>                           |
| U-233 (medium lung absorption) (e)                | 4 × 10 <sup>1</sup>     | 2 × 10 <sup>-2</sup>    | 1 × 10 <sup>2</sup>                                     | 1 × 10 <sup>5</sup>                           |
| U-233 (slow lung absorption) (f)                  | 4 × 10 <sup>1</sup>     | 6 × 10 <sup>-3</sup>    | 1 × 10 <sup>1</sup>                                     | 1 × 10 <sup>5</sup>                           |
| U-234 (fast lung absorption) (d)                  | 4 × 10 <sup>1</sup>     | 9 × 10 <sup>-2</sup>    | 1 × 10 <sup>1</sup>                                     | 1 × 10 <sup>4</sup>                           |
| U-234 (medium lung absorption) (e)                | 4 × 10 <sup>1</sup>     | 2 × 10 <sup>-2</sup>    | 1 × 10 <sup>2</sup>                                     | 1 × 10 <sup>5</sup>                           |
| U-234 (slow lung absorption) (f)                  | 4 × 10 <sup>1</sup>     | 6 × 10 <sup>-3</sup>    | 1 × 10 <sup>1</sup>                                     | 1 × 10 <sup>5</sup>                           |
| U-235 (all lung absorption types) (a) (d) (e) (f) | Unlimited               | Unlimited               | 1 × 10 <sup>1</sup> (b)                                 | 1 × 10 <sup>4</sup> (b)                       |
| U-236 (fast lung absorption) (d)                  | Unlimited               | Unlimited               | 1 × 10 <sup>1</sup>                                     | 1 × 10 <sup>4</sup>                           |
| U-236 (medium lung absorption) (e)                | 4 × 10 <sup>1</sup>     | 2 × 10 <sup>-2</sup>    | 1 × 10 <sup>2</sup>                                     | 1 × 10 <sup>5</sup>                           |
| U-236 (slow lung absorption) (f)                  | 4 × 10 <sup>1</sup>     | 6 × 10 <sup>-3</sup>    | 1 × 10 <sup>1</sup>                                     | 1 × 10 <sup>4</sup>                           |
| U-238 (all lung absorption types) (d) (e) (f)     | Unlimited               | Unlimited               | 1 × 10 <sup>1</sup> (b)                                 | 1 × 10 <sup>4</sup> (b)                       |
| U (nat)   | Unlimited               | Unlimited               | 1 × 10 <sup>0</sup> (b)                                 | 1 × 10 <sup>3</sup> (b)                       |
| U (enriched to 20% or less) (g)                   | Unlimited               | Unlimited               | 1 × 10 <sup>0</sup>                                     | 1 × 10 <sup>3</sup>                           |
| U (dep)   | Unlimited               | Unlimited               | 1 × 10 <sup>0</sup>                                     | 1 × 10 <sup>3</sup>                           |
| <b>Vanadium (23)</b>                              |                         |                         |   |   |
| V-48  | 4 × 10 <sup>-1</sup>    | 4 × 10 <sup>-1</sup>    | 1 × 10 <sup>1</sup>                                     | 1 × 10 <sup>5</sup>                           |
| V-49  | 4 × 10 <sup>1</sup>     | 4 × 10 <sup>1</sup>     | 1 × 10 <sup>4</sup>                                     | 1 × 10 <sup>7</sup>                           |
| <b>Tungsten (74)</b>                              |                         |                         |   |   |
| W-178 (a)   | 9 × 10 <sup>0</sup>     | 5 × 10 <sup>0</sup>     | 1 × 10 <sup>1</sup>                                     | 1 × 10 <sup>6</sup>                           |
| W-181   | 3 × 10 <sup>1</sup>     | 3 × 10 <sup>1</sup>     | 1 × 10 <sup>3</sup>                                     | 1 × 10 <sup>7</sup>                           |
| W-185   | 4 × 10 <sup>1</sup>     | 8 × 10 <sup>-1</sup>    | 1 × 10 <sup>4</sup>                                     | 1 × 10 <sup>7</sup>                           |
| W-187   | 2 × 10 <sup>0</sup>     | 6 × 10 <sup>-1</sup>    | 1 × 10 <sup>2</sup>                                     | 1 × 10 <sup>6</sup>                           |
| W-188 (a)   | 4 × 10 <sup>-1</sup>    | 3 × 10 <sup>-1</sup>    | 1 × 10 <sup>2</sup>                                     | 1 × 10 <sup>5</sup>                           |
| <b>Xenon (54)</b>                                 |                         |                         |   |   |
| Xe-122 (a)  | 4 × 10 <sup>-1</sup>    | 4 × 10 <sup>-1</sup>    | 1 × 10 <sup>2</sup>                                     | 1 × 10 <sup>9</sup>                           |
| Xe-123  | 2 × 10 <sup>0</sup>     | 7 × 10 <sup>-1</sup>    | 1 × 10 <sup>2</sup>                                     | 1 × 10 <sup>9</sup>                           |
| Xe-127  | 4 × 10 <sup>0</sup>     | 2 × 10 <sup>0</sup>     | 1 × 10 <sup>3</sup>                                     | 1 × 10 <sup>5</sup>                           |
| Xe-131m   | 4 × 10 <sup>1</sup>     | 4 × 10 <sup>1</sup>     | 1 × 10 <sup>4</sup>                                     | 1 × 10 <sup>4</sup>                           |
| Xe-133  | 2 × 10 <sup>1</sup>     | 1 × 10 <sup>1</sup>     | 1 × 10 <sup>3</sup>                                     | 1 × 10 <sup>4</sup>                           |
| Xe-135  | 3 × 10 <sup>0</sup>     | 2 × 10 <sup>0</sup>     | 1 × 10 <sup>3</sup>                                     | 1 × 10 <sup>10</sup>                          |
| <b>Yttrium (39)</b>                               |                         |                         |   |   |
| Y-87 (a)  | 1 × 10 <sup>0</sup>     | 1 × 10 <sup>0</sup>     | 1 × 10 <sup>1</sup>                                     | 1 × 10 <sup>6</sup>                           |
| Y-88  | 4 × 10 <sup>-1</sup>    | 4 × 10 <sup>-1</sup>    | 1 × 10 <sup>1</sup>                                     | 1 × 10 <sup>6</sup>                           |
| Y-90  | 3 × 10 <sup>-1</sup>    | 3 × 10 <sup>-1</sup>    | 1 × 10 <sup>3</sup>                                     | 1 × 10 <sup>5</sup>                           |
| Y-91  | 6 × 10 <sup>-1</sup>    | 6 × 10 <sup>-1</sup>    | 1 × 10 <sup>3</sup>                                     | 1 × 10 <sup>6</sup>                           |
| Y-91m   | 2 × 10 <sup>0</sup>     | 2 × 10 <sup>0</sup>     | 1 × 10 <sup>2</sup>                                     | 1 × 10 <sup>6</sup>                           |
| Y-92  | 2 × 10 <sup>-1</sup>    | 2 × 10 <sup>-1</sup>    | 1 × 10 <sup>2</sup>                                     | 1 × 10 <sup>5</sup>                           |
| Y-93  | 3 × 10 <sup>-1</sup>    | 3 × 10 <sup>-1</sup>    | 1 × 10 <sup>2</sup>                                     | 1 × 10 <sup>5</sup>                           |
| <b>Ytterbium (70)</b>                             |                         |                         |   |   |
| Yb-169  | 4 × 10 <sup>0</sup>     | 1 × 10 <sup>0</sup>     | 1 × 10 <sup>2</sup>                                     | 1 × 10 <sup>7</sup>                           |
| Yb-175  | 3 × 10 <sup>1</sup>     | 9 × 10 <sup>-1</sup>    | 1 × 10 <sup>3</sup>                                     | 1 × 10 <sup>7</sup>                           |
| <b>Zinc (30)</b>                                  |                         |                         |   |   |
| Zn-65   | 2 × 10 <sup>0</sup>     | 2 × 10 <sup>0</sup>     | 1 × 10 <sup>1</sup>                                     | 1 × 10 <sup>6</sup>                           |
| Zn-69   | 3 × 10 <sup>0</sup>     | 6 × 10 <sup>-1</sup>    | 1 × 10 <sup>4</sup>                                     | 1 × 10 <sup>6</sup>                           |
| Zn-69m (a)  | 3 × 10 <sup>0</sup>     | 6 × 10 <sup>-1</sup>    | 1 × 10 <sup>2</sup>                                     | 1 × 10 <sup>6</sup>                           |

Part 2 – Classification

| Radionuclide (atomic number) | A <sub>1</sub><br>(TBq) | A <sub>2</sub><br>(TBq) | Activity concentration limit for exempt material (Bq/g) | Activity limit for an exempt consignment (Bq) |
|------------------------------|-------------------------|-------------------------|---|---|
| <b>Zirconium (40)</b>        |                         |                         |   |   |
| Zr-88                        | 3 × 10 <sup>0</sup>     | 3 × 10 <sup>0</sup>     | 1 × 10 <sup>2</sup>                                     | 1 × 10 <sup>6</sup>                           |
| Zr-93                        | Unlimited               | Unlimited               | 1 × 10 <sup>3</sup> (b)                                 | 1 × 10 <sup>7</sup> (b)                       |
| Zr-95 (a)                    | 2 × 10 <sup>0</sup>     | 8 × 10 <sup>-1</sup>    | 1 × 10 <sup>1</sup>                                     | 1 × 10 <sup>6</sup>                           |
| Zr-97 (a)                    | 4 × 10 <sup>-1</sup>    | 4 × 10 <sup>-1</sup>    | 1 × 10 <sup>1</sup> (b)                                 | 1 × 10 <sup>5</sup> (b)                       |

(a) A<sub>1</sub> and/or A<sub>2</sub> values for these parent radionuclides include contributions from their progeny with half-lives less than 10 days, as listed in the following:

- Mg-28     Al-28
- Ar-42     K-42
- Ca-47     Sc-47
- Ti-44     Sc-44
- Fe-52     Mn-52m
- Fe-60     Co-60m
- Zn-69m   Zn-69
- Ge-68     Ga-68
- Rb-83     Kr-83m
- Sr-82     Rb-82
- Sr-90     Y-90
- Sr-91     Y-91m
- Sr-92     Y-92
- Y-87     Sr-87m
- Zr-95     Nb-95m
- Zr-97     Nb-97m, Nb-97
- Mo-99     Tc-99m
- Tc-95m   Tc-95
- Tc-96m   Tc-96
- Ru-103   Rh-103m
- Ru-106   Rh-106
- Pd-103   Rh-103m
- Ag-108m   Ag-108
- Ag-110m   Ag-110
- Cd-115   In-115m
- In-114m   In-114
- Sn-113   In-113m
- Sn-121m   Sn-121
- Sn-126   Sb-126m
- Te-118   Sb-118
- Te-127m   Te-127
- Te-129m   Te-129
- Te-131m   Te-131
- Te-132   I-132
- I-135     Xe-135m
- Xe-122   I-122
- Cs-137   Ba-137m
- Ba-131   Cs-131
- Ba-140   La-140
- Ce-144   Pr-144m, Pr-144
- Pm-148m   Pm-148
- Gd-146   Eu-146
- Dy-166   Ho-166
- Hf-172   Lu-172

|         |  |
|---------|--|
| W-178   | Ta-178   |
| W-188   | Re-188   |
| Re-189  | Os-189m  |
| Os-194  | Ir-194   |
| Ir-189  | Os-189m  |
| Pt-188  | Ir-188   |
| Hg-194  | Au-194   |
| Hg-195m | Hg-195   |
| Pb-210  | Bi-210   |
| Pb-212  | Bi-212, Tl-208, Po-212                                 |
| Bi-210m | Tl-206   |
| Bi-212  | Tl-208, Po-212   |
| At-211  | Po-211   |
| Rn-222  | Po-218, Pb-214, At-218, Bi-214, Po-214                 |
| Ra-223  | Rn-219, Po-215, Pb-211, Bi-211, Po-211, Tl-207         |
| Ra-224  | Rn-220, Po-216, Pb-212, Bi-212, Tl-208, Po-212         |
| Ra-225  | Ac-225, Fr-221, At-217, Bi-213, Tl-209, Po-213, Pb-209 |
| Ra-226  | Rn-222, Po-218, Pb-214, At-218, Bi-214, Po-214         |
| Ra-228  | Ac-228   |
| Ac-225  | Fr-221, At-217, Bi-213, Tl-209, Po-213, Pb-209         |
| Ac-227  | Fr-223   |
| Th-228  | Ra-224, Rn-220, Po-216, Pb-212, Bi-212, Tl-208, Po-212 |
| Th-234  | Pa-234m, Pa-234  |
| Pa-230  | Ac-226, Th-226, Fr-222, Ra-222, Rn-218, Po-214         |
| U-230   | Th-226, Ra-222, Rn-218, Po-214                         |
| U-235   | Th-231   |
| Pu-241  | U-237  |
| Pu-244  | U-240, Np-240m   |
| Am-242m | Am-242, Np-238   |
| Am-243  | Np-239   |
| Cm-247  | Pu-243   |
| Bk-249  | Am-245   |
| Cf-253  | Cm-249   |

(b) Parent nuclides and their progeny included in secular equilibrium are listed in the following (the activity to be taken into account is that of the parent nuclide only):

|         |  |
|---------|--|
| Sr-90   | Y-90   |
| Zr-93   | Nb-93m   |
| Zr-97   | Nb-97  |
| Ru-106  | Rh-106   |
| Ag-108m | Ag-108   |
| Cs-137  | Ba-137m  |
| Ce-144  | Pr-144   |
| Ba-140  | La-140   |
| Bi-212  | Tl-208 (0.36), Po-212 (0.64)   |
| Pb-210  | Bi-210, Po-210   |
| Pb-212  | Bi-212, Tl-208 (0.36), Po-212 (0.64)                                 |
| Rn-222  | Po-218, Pb-214, Bi-214, Po-214                                       |
| Ra-223  | Rn-219, Po-215, Pb-211, Bi-211, Tl-207                               |
| Ra-224  | Rn-220, Po-216, Pb-212, Bi-212, Tl-208 (0.36), Po-212 (0.64)         |
| Ra-226  | Rn-222, Po-218, Pb-214, Bi-214, Po-214, Pb-210, Bi-210, Po-210       |
| Ra-228  | Ac-228   |
| Th-228  | Ra-224, Rn-220, Po-216, Pb-212, Bi-212, Tl-208 (0.36), Po-212 (0.64) |
| Th-229  | Ra-225, Ac-225, Fr-221, At-217, Bi-213, Po-213, Pb-209               |



Part 2 – Classification

|           |  |
|-----------|--|
| Th (nat)* | Ra-228, Ac-228, Th-228, Ra-224, Rn-220, Po-216, Pb-212, Bi-212, Tl-208 (0.36), Po-212 (0.64)           |
| Th-234    | Pa-234m  |
| U-230     | Th-226, Ra-222, Rn-218, Po-214   |
| U-232     | Th-228, Ra-224, Rn-220, Po-216, Pb-212, Bi-212, Tl-208 (0.36), Po-212 (0.64)                           |
| U-235     | Th-231   |
| U-238     | Th-234, Pa-234m  |
| U (nat)*  | Th-234, Pa-234m, U-234, Th-230, Ra-226, Rn-222, Po-218, Pb-214, Bi-214, Po-214, Pb-210, Bi-210, Po-210 |
| Np-237    | Pa-233   |
| Am-242m   | Am-242   |
| Am-243    | Np-239   |

- (c) The quantity may be determined from a measurement of the rate of decay or a measurement of the dose rate at a prescribed distance from the source.
- (d) These values apply only to compounds of uranium that take the chemical form of UF<sub>6</sub>, UO<sub>2</sub>F<sub>2</sub> and UO<sub>2</sub>(NO<sub>3</sub>)<sub>2</sub> in both normal and accident conditions of transport.
- (e) These values apply only to compounds of uranium that take the chemical form of UO<sub>3</sub>, UF<sub>4</sub>, UCl<sub>4</sub> and hexavalent compounds in both normal and accident conditions of transport.
- (f) These values apply to all compounds of uranium other than those specified in (d) and (e) above.
- (g) These values apply to unirradiated uranium only.

2.7.2.2.2 For individual radionuclides:

- .1 which are not listed in table 2.7.2.2.1, the determination of the basic radionuclide values referred to in 2.7.2.2.1 shall require multilateral approval. For these radionuclides, activity concentration limits for exempt material and activity limits for exempt consignments shall be calculated in accordance with the principles established in the *Radiation Protection and Safety of Radiation Sources: International Basic Safety Standards, IAEA Safety Standards Series No. GSR Part 3, IAEA, Vienna (2014)*. It is permissible to use an A<sub>2</sub> value calculated using a dose coefficient for the appropriate lung absorption type as recommended by the International Commission on Radiological Protection, if the chemical forms of each radionuclide under both normal and accident conditions of transport are taken into consideration. Alternatively, the radionuclide values in table 2.7.2.2.2 may be used without obtaining competent authority approval;
- .2 In instruments or articles in which the radioactive material is enclosed or is included as a component part of the instrument or other manufactured article and which meet 2.7.2.4.1.3.3, alternative basic radionuclide values to those in table 2.7.2.2.1 for the activity limit for an exempt consignment are permitted and shall require multilateral approval. Such alternative activity limits for an exempt consignment shall be calculated in accordance with the principles set out in GSR Part 3.

Table 2.7.2.2.2 – Basic radionuclide values for unknown radionuclides or mixtures

| Radioactive contents  | A <sub>1</sub><br>(TBq) | A <sub>2</sub><br>(TBq) | Activity concentration limit for exempt material (Bq/g) | Activity limit for exempt consignments (Bq) |
|---|-------------------------|-------------------------|---|---|
| Only beta or gamma emitting nuclides are known to be present                        | 0.1                     | 0.02                    | 1 × 10 <sup>1</sup>                                     | 1 × 10 <sup>4</sup>                         |
| Alpha emitting nuclides but no neutron emitters are known to be present             | 0.2                     | 9 × 10 <sup>-5</sup>    | 1 × 10 <sup>-1</sup>                                    | 1 × 10 <sup>3</sup>                         |
| Neutron emitting nuclides are known to be present or no relevant data are available | 0.001                   | 9 × 10 <sup>-5</sup>    | 1 × 10 <sup>-1</sup>                                    | 1 × 10 <sup>3</sup>                         |

2.7.2.2.3 In the calculations of A<sub>1</sub> and A<sub>2</sub> for a radionuclide not in table 2.7.2.2.1, a single radioactive decay chain in which the radionuclides are present in their naturally occurring proportions, and in which no progeny nuclide has a half-life either longer than 10 days or longer than that of the parent nuclide, shall be considered as a single radionuclide; and the activity to be taken into account and the A<sub>1</sub> or A<sub>2</sub> value to be applied shall be those corresponding to the parent nuclide of that chain. In the case of radioactive decay chains in which any

\* In the case of Th-natural, the parent nuclide is Th-232, in the case of U-natural the parent nuclide is U-238.

progeny nuclide has a half-life either longer than 10 days or greater than that of the parent nuclide, the parent and such progeny nuclides shall be considered as mixtures of different nuclides.

2.7.2.2.4 For mixtures of radionuclides, the basic radionuclide values referred to in 2.7.2.2.1 may be determined as follows:

$$X_m = \frac{1}{\sum_i \frac{f(i)}{X(i)}}$$

where:

- $f(i)$  is the fraction of activity or activity concentration of radionuclide  $i$  in the mixture;
- $X(i)$  is the appropriate value of  $A_1$  or  $A_2$ , or the activity concentration limit for exempt material or the activity limit for an exempt consignment, as appropriate, for the radionuclide  $i$ ; and
- $X_m$  is the derived value of  $A_1$  or  $A_2$ , or the activity concentration limit for exempt material or the activity limit for an exempt consignment in the case of a mixture.

2.7.2.2.5 When the identity of each radionuclide is known but the individual activities of some of the radionuclides are not known, the radionuclides may be grouped and the lowest radionuclide value, as appropriate, for the radionuclides in each group may be used in applying the formulae in 2.7.2.2.4 and 2.7.2.4.4. Groups may be based on the total alpha activity and the total beta/gamma activity when these are known, using the lowest radionuclide values for the alpha emitters or beta/gamma emitters, respectively.

2.7.2.2.6 For individual radionuclides or for mixtures of radionuclides for which relevant data are not available, the values shown in table 2.7.2.2.2 shall be used.

### 2.7.2.3 Determination of other material characteristics

#### 2.7.2.3.1 *Low specific activity (LSA) material*

2.7.2.3.1.1 [Reserved]

2.7.2.3.1.2 LSA material shall be in one of three groups:

- .1 LSA-I
  - .1 uranium and thorium ores and concentrates of such ores, and other ores containing naturally occurring radionuclides;
  - .2 Natural uranium, depleted uranium, natural thorium or their compounds or mixtures, that are unirradiated and in solid or liquid form;
  - .3 radioactive material for which the  $A_2$  value is unlimited. Fissile material may be included only if excepted under 2.7.2.3.5; or
  - .4 other radioactive material in which the activity is distributed throughout and the estimated average specific activity does not exceed 30 times the values for activity concentration specified in 2.7.2.2.1 to 2.7.2.2.6. Fissile material may be included only if excepted under 2.7.2.3.5;
- .2 LSA-II
  - .1 water with tritium concentration up to 0.8 TBq/L;
  - .2 other material in which the activity is distributed throughout and the estimated average specific activity does not exceed  $10^{-4}A_2/g$  for solids and gases, and  $10^{-5}A_2/g$  for liquids;
- .3 LSA-III – Solids (e.g. consolidated wastes, activated materials), excluding powders, in which:
  - .1 the radioactive material is distributed throughout a solid or a collection of solid objects, or is essentially uniformly distributed in a solid compact binding agent (such as concrete, bitumen and ceramic);
  - .2 the estimated average specific activity of the solid, excluding any shielding material, does not exceed  $2 \times 10^{-3}A_2/g$ .

2.7.2.3.1.3 Deleted.

2.7.2.3.1.4 Deleted.

2.7.2.3.1.5 Deleted.

**Part 2 – Classification****2.7.2.3.2 Surface contaminated object (SCO)**

SCO is classified in one of three groups:

- .1 SCO-I: A solid object on which:
  - .1 the non-fixed contamination on the accessible surface averaged over 300 cm<sup>2</sup> (or the area of the surface if less than 300 cm<sup>2</sup>) does not exceed 4 Bq/cm<sup>2</sup> for beta and gamma emitters and low-toxicity alpha emitters, or 0.4 Bq/cm<sup>2</sup> for all other alpha emitters;
  - .2 the fixed contamination on the accessible surface averaged over 300 cm<sup>2</sup> (or the area of the surface if less than 300 cm<sup>2</sup>) does not exceed  $4 \times 10^4$  Bq/cm<sup>2</sup> for beta and gamma emitters and low-toxicity alpha emitters, or  $4 \times 10^3$  Bq/cm<sup>2</sup> for all other alpha emitters; and
  - .3 the non-fixed contamination plus the fixed contamination on the inaccessible surface averaged over 300 cm<sup>2</sup> (or the area of the surface if less than 300 cm<sup>2</sup>) does not exceed  $4 \times 10^4$  Bq/cm<sup>2</sup> for beta and gamma emitters and low-toxicity alpha emitters, or  $4 \times 10^3$  Bq/cm<sup>2</sup> for all other alpha emitters;
- .2 SCO-II: A solid object on which either the fixed or non-fixed contamination on the surface exceeds the applicable limits specified for SCO-I in 2.7.2.3.2.1 above and on which:
  - .1 the non-fixed contamination on the accessible surface averaged over 300 cm<sup>2</sup> (or the area of the surface if less than 300 cm<sup>2</sup>) does not exceed 400 Bq/cm<sup>2</sup> for beta and gamma emitters and low-toxicity alpha emitters, or 40 Bq/cm<sup>2</sup> for all other alpha emitters;
  - .2 the fixed contamination on the accessible surface averaged over 300 cm<sup>2</sup> (or the area of the surface if less than 300 cm<sup>2</sup>) does not exceed  $8 \times 10^5$  Bq/cm<sup>2</sup> for beta and gamma emitters and low-toxicity alpha emitters, or  $8 \times 10^4$  Bq/cm<sup>2</sup> for all other alpha emitters; and
  - .3 the non-fixed contamination plus the fixed contamination on the inaccessible surface averaged over 300 cm<sup>2</sup> (or the area of the surface if less than 300 cm<sup>2</sup>) does not exceed  $8 \times 10^5$  Bq/cm<sup>2</sup> for beta and gamma emitters and low-toxicity alpha emitters, or  $8 \times 10^4$  Bq/cm<sup>2</sup> for all other alpha emitters.
- .3 SCO-III: A large solid object which, because of its size, cannot be transported in a type of package described in this Code and for which:
  - .1 all openings are sealed to prevent release of radioactive material during conditions defined in 4.1.9.2.4.5;
  - .2 the inside of the object is as dry as practicable;
  - .3 the non-fixed contamination on the external surfaces does not exceed the limits specified in 4.1.9.1.2; and
  - .4 the non-fixed contamination plus the fixed contamination on the inaccessible surface averaged over 300 cm<sup>2</sup> does not exceed  $8 \times 10^5$  Bq/cm<sup>2</sup> for beta and gamma emitters and low toxicity alpha emitters, or  $8 \times 10^4$  Bq/cm<sup>2</sup> for all other alpha emitters.

**2.7.2.3.3 Special form radioactive material**

- 2.7.2.3.3.1 .1 Special form radioactive material shall have at least one dimension not less than 5 mm.
- .2 When a sealed capsule constitutes part of the special form radioactive material, the capsule shall be so manufactured that it can be opened only by destroying it.
- .3 The design for special form radioactive material requires unilateral approval.
- 2.7.2.3.3.2 Special form radioactive material shall be of such a nature or shall be so designed that, if it is subjected to the tests specified in 2.7.2.3.3.4 to 2.7.2.3.3.8, it shall meet the following requirements:
  - .1 It would not break or shatter under the impact, percussion and bending tests 2.7.2.3.3.5.1, 2.7.2.3.3.5.2, 2.7.2.3.3.5.3, and 2.7.2.3.3.6.1 as applicable;
  - .2 It would not melt or disperse in the applicable heat test 2.7.2.3.3.5.4 or 2.7.2.3.3.6.2 as applicable; and
  - .3 The activity in the water from the leaching tests specified in 2.7.2.3.3.7 and 2.7.2.3.3.8 would not exceed 2 kBq; or alternatively for sealed sources, the leakage rate for the volumetric leakage assessment test specified in ISO 9978:1992, *Radiation protection – Sealed radioactive sources – Leakage test methods*, would not exceed the applicable acceptance threshold acceptable to the competent authority.
- 2.7.2.3.3.3 Demonstration of compliance with the performance standards in 2.7.2.3.3.2 shall be in accordance with 6.4.12.1 and 6.4.12.2.
- 2.7.2.3.3.4 Specimens that comprise or simulate special form radioactive material shall be subjected to the impact test, the percussion test, the bending test, and the heat test specified in 2.7.2.3.3.5 or alternative tests as authorized in 2.7.2.3.3.6. A different specimen may be used for each of the tests. Following each test, a leaching assessment or volumetric leakage test shall be performed on the specimen by a method no less sensitive than the methods given in 2.7.2.3.3.7 for indispersible solid material or 2.7.2.3.3.8 for encapsulated material.

- 2.7.2.3.3.5 The relevant test methods are:
- .1 *Impact test*: The specimen shall drop onto the target from a height of 9 m. The target shall be as defined in 6.4.14;
  - .2 *Percussion test*: The specimen shall be placed on a sheet of lead which is supported by a smooth solid surface and struck by the flat face of a mild steel bar so as to cause an impact equivalent to that resulting from a free drop of 1.4 kg from a height of 1 m. The lower part of the bar shall be 25 mm in diameter with the edges rounded off to a radius of  $(3.0 \pm 0.3)$  mm. The lead, of hardness number 3.5 to 4.5 on the Vickers scale and not more than 25 mm thick, shall cover an area greater than that covered by the specimen. A fresh surface of lead shall be used for each impact. The bar shall strike the specimen so as to cause maximum damage;
  - .3 *Bending test*: The test shall apply only to long, slender sources with both a minimum length of 10 cm and a length to minimum width ratio of not less than 10. The specimen shall be rigidly clamped in a horizontal position so that one half of its length protrudes from the face of the clamp. The orientation of the specimen shall be such that the specimen will suffer maximum damage when its free end is struck by the flat face of a steel bar. The bar shall strike the specimen so as to cause an impact equivalent to that resulting from a free vertical drop of 1.4 kg from a height of 1 m. The lower part of the bar shall be 25 mm in diameter with the edges rounded off to a radius of  $(3.0 \pm 0.3)$  mm;
  - .4 *Heat test*: The specimen shall be heated in air to a temperature of 800°C and held at that temperature for a period of 10 minutes and shall then be allowed to cool.
- 2.7.2.3.3.6 Specimens that comprise or simulate radioactive material enclosed in a sealed capsule may be excepted from:
- .1 The tests prescribed in 2.7.2.3.3.5.1 and 2.7.2.3.3.5.2 provided that the specimens are alternatively subjected to the impact test prescribed in ISO 2919:2012, *Radiation Protection – Sealed Radioactive Sources – General requirements and classification*:
    - .1 the class 4 impact test if the mass of the special form radioactive material is less than 200 g; and
    - .2 the class 5 impact test if the mass of the special form radioactive material is equal to or more than 200 g but is less than 500 g.
  - .2 The test prescribed in 2.7.2.3.3.5.4 provided they are alternatively subjected to the class 6 temperature test specified in ISO 2919:2012, *Radiation protection – Sealed radioactive sources – General requirements and classification*.
- 2.7.2.3.3.7 For specimens which comprise or simulate indispersible solid material, a leaching assessment shall be performed as follows:
- .1 The specimen shall be immersed for 7 days in water at ambient temperature. The volume of water to be used in the test shall be sufficient to ensure that at the end of the 7-day test period the free volume of the unabsorbed and unreacted water remaining shall be at least 10% of the volume of the solid test sample itself. The water shall have an initial pH of 6 to 8 and a maximum conductivity of 1 mS/m at 20°C;
  - .2 The water and the specimen shall then be heated to a temperature of  $(50 \pm 5)$ °C and maintained at this temperature for 4 hours;
  - .3 The activity of the water shall then be determined;
  - .4 The specimen shall then be kept for at least 7 days in still air at not less than 30°C and relative humidity not less than 90%;
  - .5 The specimen shall then be immersed in water of the same specification as in 2.7.2.3.3.7.1 above and the water and the specimen heated to  $(50 \pm 5)$ °C and maintained at this temperature for 4 hours;
  - .6 The activity of the water shall then be determined.
- 2.7.2.3.3.8 For specimens which comprise or simulate radioactive material enclosed in a sealed capsule, either a leaching assessment or a volumetric leakage assessment shall be performed as follows:
- .1 The leaching assessment shall consist of the following steps:
    - .1 the specimen shall be immersed in water at ambient temperature. The water shall have an initial pH of 6 to 8 with a maximum conductivity of 1 mS/m at 20°C;
    - .2 the water and specimen shall then be heated to a temperature of  $(50 \pm 5)$ °C and maintained at this temperature for 4 hours;
    - .3 the activity of the water shall then be determined;
    - .4 the specimen shall then be kept for at least 7 days in still air at not less than 30°C and relative humidity of not less than 90%;
    - .5 the process in .1, .2 and .3 shall be repeated.
  - .2 The alternative volumetric leakage assessment shall comprise any of the tests prescribed in ISO 9978:1992, *Radiation protection – Sealed radioactive sources – Leakage test methods*, provided that they are acceptable to the competent authority.

**Part 2 – Classification****2.7.2.3.4 Low dispersible radioactive material**

2.7.2.3.4.1 The design for low dispersible radioactive material shall require multilateral approval. Low dispersible radioactive material shall be such that the total amount of this radioactive material in a package, taking into account the provisions of 6.4.8.14, shall meet the following provisions:

- .1 The dose rate at 3 m from the unshielded radioactive material does not exceed 10 mSv/h;
- .2 If subjected to the tests specified in 6.4.20.3 and 6.4.20.4, the airborne release in gaseous and particulate forms of up to 100  $\mu\text{m}$  aerodynamic equivalent diameter would not exceed  $100A_2$ . A separate specimen may be used for each test; and
- .3 If subjected to the test specified in 2.7.2.3.4.3, the activity in the water would not exceed  $100A_2$ . In the application of this test, the damaging effects of the tests specified in 2.7.2.3.4.1.2 above shall be taken into account.

2.7.2.3.4.2 Low dispersible material shall be tested as follows:

A specimen that comprises or simulates low dispersible radioactive material shall be subjected to the enhanced thermal test specified in 6.4.20.3 and the impact test specified in 6.4.20.4. A different specimen may be used for each of the tests. Following each test, the specimen shall be subjected to the leach test specified in 2.7.2.3.1.4. After each test it shall be determined if the applicable provisions of 2.7.2.3.4.1 have been met.

2.7.2.3.4.3 A solid material sample representing the entire contents of the package shall be immersed for seven days in water at ambient temperature. The volume of water to be used in the test shall be sufficient to ensure that at the end of the seven-day test period the free volume of the unabsorbed and unreacted water remaining shall be at least 10% of the volume of the solid test sample itself. The water shall have an initial pH of 6 to 8 and a maximum conductivity of 1 mS/m at 20°C. The total activity of the free volume of water shall be measured following the seven-day immersion of the test sample.

2.7.2.3.4.4 Demonstration of compliance with the performance standards in 2.7.2.3.4.1, 2.7.2.3.4.2 and 2.7.2.3.4.3 shall be in accordance with 6.4.12.1 and 6.4.12.2.

**2.7.2.3.5 Fissile material**

Fissile material and packages containing fissile material shall be classified under the relevant entry as “FISSILE” in accordance with table 2.7.2.1.1 unless excepted by one of the provisions of subparagraphs .1 to .6 below and transported subject to the requirements of 5.1.5.5. All provisions apply only to material in packages that meets the requirements of 6.4.7.2 unless unpackaged material is specifically allowed in the provision.

- .1 uranium enriched in uranium-235 to a maximum of 1% by mass, and with a total plutonium and uranium-233 content not exceeding 1% of the mass of uranium-235, provided that the fissile nuclides are distributed essentially homogeneously throughout the material. In addition, if uranium-235 is present in metallic, oxide or carbide forms, it shall not form a lattice arrangement;
- .2 liquid solutions of uranyl nitrate enriched in uranium-235 to a maximum of 2% by mass, with a total plutonium and uranium-233 content not exceeding 0.002% of the mass of uranium, and with a minimum nitrogen to uranium atomic ratio (N/U) of 2;
- .3 uranium with a maximum uranium enrichment of 5% by mass uranium-235 provided:
  - .1 there is no more than 3.5 g of uranium-235 per package;
  - .2 the total plutonium and uranium-233 content does not exceed 1% of the mass of uranium-235 per package;
  - .3 transport of the package is subject to the consignment limit provided in 5.1.5.5.3;
- .4 fissile nuclides with a total mass not greater than 2 g per package provided the package is transported subject to the consignment limit provided in 5.1.5.5.4;
- .5 fissile nuclides with a total mass not greater than 45 g either packaged or unpackaged subject to the requirements of 5.1.5.5.5;
- .6 a fissile material that meets the requirements of 5.1.5.5.2, 2.7.2.3.6 and 5.1.5.2.1.

2.7.2.3.6 Fissile material excepted from classification as “FISSILE” under 2.7.2.3.5.6 shall be subcritical without the need for accumulation control under the following conditions:

- .1 the conditions of 6.4.11.1 (a);
- .2 the conditions consistent with the assessment provisions stated in 6.4.11.12 (b) and 6.4.11.13 (b) for packages; and
- .3 the conditions specified in 6.4.11.11 (a), if transported by air.

**2.7.2.4 Classification of packages or unpacked material**

The quantity of radioactive material in a package shall not exceed the relevant limits for the package type as specified below.

**2.7.2.4.1 Classification as excepted package**

**2.7.2.4.1.1** A package may be classified as an excepted package if it meets one of the following conditions:

- .1 it is an empty package having contained radioactive material;
- .2 it contains instruments or articles not exceeding the activity limits specified in columns (2) and (3) of table 2.7.2.4.1.2;
- .3 it contains articles manufactured of natural uranium, depleted uranium or natural thorium;
- .4 it contains radioactive material not exceeding the activity limits specified in column (4) of table 2.7.2.4.1.2; or
- .5 it contains less than 0.1 kg of uranium hexafluoride not exceeding the activity limits specified in column (4) of table 2.7.2.4.1.2.

**2.7.2.4.1.2** A package containing radioactive material may be classified as an excepted package provided that the dose rate at any point on its external surface does not exceed 5 µSv/h.

**Table 2.7.2.4.1.2 – Activity limits for excepted packages**

| Physical state of contents | Instruments or article   |                             | Material package limits <sup>a</sup> |
|----------------------------|--------------------------|-----------------------------|--------------------------------------|
|                            | Item limits <sup>a</sup> | Package limits <sup>a</sup> |                                      |
| (1)                        | (2)                      | (3)                         | (4)                                  |
| <b>Solids</b>              |                          |                             |                                      |
| special form               | $10^{-2} A_1$            | $A_1$                       | $10^{-3} A_1$                        |
| other form                 | $10^{-2} A_2$            | $A_2$                       | $10^{-3} A_2$                        |
| <b>Liquids</b>             | $10^{-3} A_2$            | $10^{-1} A_2$               | $10^{-4} A_2$                        |
| <b>Gases</b>               |                          |                             |                                      |
| tritium                    | $2 \times 10^{-2} A_2$   | $2 \times 10^{-1} A_2$      | $2 \times 10^{-2} A_2$               |
| special form               | $10^{-3} A_1$            | $10^{-2} A_1$               | $10^{-3} A_1$                        |
| other forms                | $10^{-3} A_2$            | $10^{-2} A_2$               | $10^{-3} A_2$                        |

<sup>a</sup> For mixtures of radionuclides, see 2.7.2.2.4 to 2.7.2.2.6.

**2.7.2.4.1.3** Radioactive material which is enclosed in or is included as a component part of an instrument or other manufactured article may be classified under UN 2911, RADIOACTIVE MATERIAL, EXCEPTED PACKAGE – INSTRUMENTS or ARTICLES provided that:

- .1 the dose rate at 10 cm from any point on the external surface of any unpackaged instrument or article is not greater than 0.1 mSv/h; and
- .2 each instrument or manufactured article bears the mark “RADIOACTIVE” on its external surface except for the following:
  - .1 radioluminescent time-pieces or devices;
  - .2 consumer products that either have received regulatory approval in accordance with 1.5.1.4.5 or do not individually exceed the activity limit for an exempt consignment in table 2.7.2.2.1 (column 5), provided such products are transported in a package that bears the mark “RADIOACTIVE” on its internal surface in such a manner that a warning of the presence of radioactive material is visible on opening the package;
  - .3 other instruments or articles too small to bear the mark “RADIOACTIVE”, provided that they are transported in a package that bears the mark “RADIOACTIVE” on its internal surface in such a manner that a warning of the presence of radioactive material is visible on opening the package; and
- .3 the active material is completely enclosed by non-active components (a device performing the sole function of containing radioactive material shall not be considered to be an instrument or manufactured article);
- .4 the limits specified in columns 2 and 3 of table 2.7.2.4.1.2 are met for each individual item and each package, respectively;
- .5 reserved; and
- .6 if the package contains fissile material, one of the provisions of sub-paragraphs .1 to .6 of 2.7.2.3.5 applies.



Part 2 – Classification

2.7.2.4.1.4 Radioactive material in forms other than as specified in 2.7.2.4.1.3 and with an activity not exceeding the limits specified in column 4 of table 2.7.2.4.1.2, may be classified under UN 2910, RADIOACTIVE MATERIAL, EXCEPTED PACKAGE – LIMITED QUANTITY OF MATERIAL provided that:

- .1 the package retains its radioactive contents under routine conditions of transport;
- .2 the package bears the mark “RADIOACTIVE” on either:
  - .1 an internal surface in such a manner that a warning of the presence of radioactive material is visible on opening the package; or
  - .2 the outside of the package, where it is impractical to mark an internal surface; and
- .3 if the package contains fissile material, one of the provisions of sub-paragraphs .1 to .6 of 2.7.2.3.5 applies.

2.7.2.4.1.5 Uranium hexafluoride not exceeding the limits specified in column 4 of table 2.7.2.4.1.2 may be classified under UN 3507 URANIUM HEXAFLUORIDE, RADIOACTIVE MATERIAL, EXCEPTED PACKAGE, less than 0.1 kg per package, non-fissile or fissile-excepted, provided that:

- .1 the mass of uranium hexafluoride in the package is less than 0.1 kg; and
- .2 the conditions of 2.7.2.4.5.1 and 2.7.2.4.1.4.1 and 2.7.2.4.1.4.2 are met.

2.7.2.4.1.6 Articles manufactured of natural uranium, depleted uranium or natural thorium and articles in which the sole radioactive material is unirradiated natural uranium, unirradiated depleted uranium or unirradiated natural thorium may be classified under UN 2909, RADIOACTIVE MATERIAL, EXCEPTED PACKAGE – ARTICLES MANUFACTURED FROM NATURAL URANIUM or DEPLETED URANIUM or NATURAL THORIUM, provided that the outer surface of the uranium or thorium is enclosed in an inactive sheath made of metal or some other substantial material.

2.7.2.4.1.7 An empty packaging which had previously contained radioactive material may be classified under UN 2908, RADIOACTIVE MATERIAL, EXCEPTED PACKAGE – EMPTY PACKAGING, provided that:

- .1 it is in a well-maintained condition and securely closed;
- .2 the outer surface of any uranium or thorium in its structure is covered with an inactive sheath made of metal or some other substantial material;
- .3 the level of internal non-fixed contamination, when averaged over any 300 cm<sup>2</sup>, does not exceed:
  - .1 400 Bq/cm<sup>2</sup> for beta and gamma emitters and low-toxicity alpha emitters; and
  - .2 40 Bq/cm<sup>2</sup> for all other alpha emitters;
- .4 any labels which may have been displayed on it in conformity with 5.2.2.1.12.1 are no longer visible; and
- .5 if the packaging has contained fissile material, one of the provisions of sub-paragraphs .1 to .6 of 2.7.2.3.5 or one of the provisions for exclusion in 2.7.1.3 applies.

2.7.2.4.2 **Classification as low specific activity (LSA) material**

Radioactive material may only be classified as LSA material if the definition of LSA in 2.7.1.3 and the conditions of 2.7.2.3.1, 4.1.9.2 and 7.1.4.5.1 are met.

2.7.2.4.3 **Classification as surface contaminated object (SCO)**

Radioactive material may be classified as SCO if the definition of SCO in 2.7.1.3 and the conditions of 2.7.2.3.2, 4.1.9.2 and 7.1.4.5.1 are met.

2.7.2.4.4 **Classification as Type A package**

Packages containing radioactive material may be classified as Type A packages provided that the following conditions are met:

Type A packages shall not contain activities greater than either of the following:

- .1 for special form radioactive material –  $A_1$ ;
- .2 for all other radioactive material –  $A_2$ .

For mixtures of radionuclides whose identities and respective activities are known, the following condition shall apply to the radioactive contents of a Type A package:

$$\sum_i \frac{B(i)}{A_1(i)} + \sum_j \frac{C(j)}{A_2(j)} \leq 1$$

where:

- $B(i)$  is the activity of radionuclide  $i$  as special form radioactive material;
- $A_1(i)$  is the  $A_1$  value for radionuclide  $i$ ;



$C(j)$  is the activity of radionuclide  $j$  as other than special form radioactive material;  
 $A_2(j)$  is the  $A_2$  value for radionuclide  $j$ .

#### 2.7.2.4.5 **Classification of uranium hexafluoride**

2.7.2.4.5.1 Uranium hexafluoride shall only be assigned to:

- .1 UN 2977, RADIOACTIVE MATERIAL, URANIUM HEXAFLUORIDE, FISSILE;
- .2 UN 2978, RADIOACTIVE MATERIAL, URANIUM HEXAFLUORIDE, non-fissile or fissile-excepted; or
- .3 UN 3507, URANIUM HEXAFLUORIDE, RADIOACTIVE MATERIAL, EXCEPTED PACKAGE less than 0.1 kg per package, non-fissile or fissile-excepted.

2.7.2.4.5.2 The contents of a package containing uranium hexafluoride shall comply with the following requirements:

- .1 for UN Nos. 2977 and 2978, the mass of uranium hexafluoride shall not be different from that allowed for the package design, and for UN 3507, the mass of uranium hexafluoride shall be less than 0.1 kg;
- .2 the mass of uranium hexafluoride shall not be greater than a value that would lead to an ullage smaller than 5% at the maximum temperature of the package as specified for the plant systems where the package shall be used; and
- .3 the uranium hexafluoride shall be in solid form and the internal pressure shall not be above atmospheric pressure when presented for transport.

#### 2.7.2.4.6 **Classification as Type B(U), Type B(M) or Type C packages**

2.7.2.4.6.1 Packages not otherwise classified in 2.7.2.4 (2.7.2.4.1 to 2.7.2.4.5) shall be classified in accordance with the competent authority certificate of approval for the package issued by the country of origin of design.

2.7.2.4.6.2 The contents of a Type B(U), Type B(M) or Type C package shall be as specified in the certificate of approval.

#### 2.7.2.5 **Special arrangements**

Radioactive material shall be classified as transported under special arrangement when it is intended to be transported in accordance with 1.5.4.



## Chapter 2.8

### Class 8 – Corrosive substances

#### 2.8.1 Definition, general provisions and properties

##### 2.8.1.1 Definition

2.8.1.1.1 *Corrosive substances* are substances which, by chemical action, will cause irreversible damage to the skin, or, in the case of leakage, will materially damage, or even destroy, other goods or the means of transport.

2.8.1.1.2 For substances and mixtures that are corrosive to skin, general classification provisions are provided in section 2.8.2. Skin corrosion refers to the production of irreversible damage to the skin, namely, visible necrosis through the epidermis and into the dermis occurring after exposure to a substance or mixture.

2.8.1.1.3 Liquids and solids which may become liquid during transport, which are judged not to be skin corrosive shall still be considered for their potential to cause corrosion to certain metal surfaces in accordance with the criteria in 2.8.3.3.2.

##### 2.8.1.2 Properties

2.8.1.2.1 In cases where particularly severe personal damage is to be expected, a note to that effect is made in the Dangerous Goods List in chapter 3.2 in the wording “causes (severe) burns to skin, eyes and mucous membranes”.

2.8.1.2.2 Many substances are sufficiently volatile to evolve vapour irritating to the nose and eyes. If so, this fact is mentioned in the Dangerous Goods List in chapter 3.2 in the wording “vapour irritates mucous membranes”.

2.8.1.2.3 A few substances may produce toxic gases when decomposed by very high temperatures. In these cases the statement “when involved in a fire, evolves toxic gases” appears in the Dangerous Goods List in chapter 3.2.

2.8.1.2.4 In addition to direct destructive action in contact with skin or mucous membranes, some substances in this class are toxic or harmful. Poisoning may result if they are swallowed, or if their vapour is inhaled; some of them even may penetrate the skin. Where appropriate, a statement is made to that effect in the Dangerous Goods List in chapter 3.2.

2.8.1.2.5 All substances in this class have a more or less destructive effect on materials such as metals and textiles.

2.8.1.2.5.1 In the Dangerous Goods List, the term “corrosive to most metals” means that any metal likely to be present in a ship, or in its cargo, may be attacked by the substance or its vapour.

2.8.1.2.5.2 The term “corrosive to aluminium, zinc, and tin” implies that iron or steel is not damaged in contact with the substance.

2.8.1.2.5.3 A few substances in this class can corrode glass, earthenware and other siliceous materials. Where appropriate, this is stated in the Dangerous Goods List in chapter 3.2.

2.8.1.2.6 Many substances in this class only become corrosive after having reacted with water, or with moisture in the air. This fact is indicated in the Dangerous Goods List in chapter 3.2 by the words “in the presence of moisture...”. The reaction of water with many substances is accompanied by the liberation of irritating and corrosive gases. Such gases usually become visible as fumes in the air.

2.8.1.2.7 A few substances in this class generate heat in reaction with water or organic materials, including wood, paper, fibres, some cushioning materials and certain fats and oils. Where appropriate, this is indicated in the Dangerous Goods List in chapter 3.2.

## 2.8.2 General classification provisions

2.8.2.1 Substances and mixtures of class 8 are divided among the three packing groups according to their degree of danger in transport:

- .1 Packing group I: very dangerous substances and mixtures;
- .2 Packing group II: substances and mixtures presenting medium danger;
- .3 Packing group III: substances and mixtures that present minor danger.

2.8.2.2 Allocation of substances listed in the Dangerous Goods List in chapter 3.2 to the packing groups in class 8 has been made on the basis of experience taking into account such additional factors as inhalation risk (see 2.8.2.4) and reactivity with water (including the formation of dangerous decomposition products).

2.8.2.3 New substances and mixtures can be assigned to packing groups on the basis of the length of time of contact necessary to produce irreversible damage of intact skin tissue in accordance with the criteria in 2.8.3. Alternatively, for mixtures, the criteria in 2.8.4 can be used.

2.8.2.4 A substance or mixture meeting the criteria of class 8 having an inhalation toxicity of dusts and mists (LC<sub>50</sub>) in the range of packing group I, but toxicity through oral ingestion or dermal contact only in the range of packing group III or less, shall be allocated to class 8 (see note under 2.6.2.2.4.1).

## 2.8.3 Packing group assignment for substances and mixtures

2.8.3.1 Existing human and animal data including information from single or repeated exposure shall be the first line of evaluation, as they give information directly relevant to effects on the skin.

2.8.3.2 In assigning the packing group in accordance with 2.8.2.3, account shall be taken of human experience in instances of accidental exposure. In the absence of human experience, classification shall be based on data obtained from experiments in accordance with OECD Test Guidelines Nos. 404,<sup>\*</sup> 435,<sup>†</sup> 431,<sup>‡</sup> or 430<sup>§</sup>. A substance or mixture which is determined not to be corrosive in accordance with one of these or non-classified in accordance with OECD Test Guideline No. 439,<sup>¶</sup> may be considered not to be corrosive to skin for the purposes of this Code without further testing. If the test results indicate that the substance or mixture is corrosive and not assigned to packing group I, but the test method does not allow discrimination between packing groups II and III, it shall be considered to be packing group II. If the test results indicate that the substance or mixture is corrosive, but the test method does not allow discrimination between packing groups, it shall be assigned to packing group I if no other test results indicate a different packing group.

2.8.3.3 Packing groups are assigned to corrosive substances in accordance with the following criteria (see table 2.8.3.4):

- .1 Packing group I is assigned to substances that cause irreversible damage of intact skin tissue within an observation period of up to 60 minutes starting after the exposure time of three minutes or less.
- .2 Packing group II is assigned to substances that cause irreversible damage of intact skin tissue within an observation period of up to 14 days starting after the exposure time of more than three minutes but not more than 60 minutes.
- .3 Packing group III is assigned to substances that:
  - .1 cause irreversible damage of intact skin tissue within an observation period up to 14 days starting after the exposure time of more than 60 minutes but not more than 4 hours; or
  - .2 are judged not to cause irreversible damage of intact skin tissue but which exhibit a corrosion rate on either steel or aluminium surfaces exceeding 6.25 mm a year at a test temperature of 55°C when tested on both materials. For the purposes of testing steel, type S235JR+CR (1.0037 resp. St 37-2), S275J2G3+CR (1.0144 resp. St 44-3), ISO 3574, Unified Numbering System (UNS) G10200 or SAE 1020, and for testing aluminium, non-clad, types 7075-T6 or AZ5GU-T6 shall be used. An acceptable test is prescribed in the *Manual of Tests and Criteria*, part III, section 37.

**Note:** Where an initial test on either steel or aluminium indicates the substance being tested is corrosive, the follow-up test on the other metal is not required.

<sup>\*</sup> OECD Guideline for the testing of chemicals No. 404 Acute Dermal Irritation/Corrosion 2015.

<sup>†</sup> OECD Guideline for the testing of chemicals No. 435 In Vitro Membrane Barrier Test Method for Skin Corrosion 2015.

<sup>‡</sup> OECD Guideline for the testing of chemicals No. 431 In Vitro Skin Corrosion: Reconstructed Human Epidermis (RHE) Test Method 2016.

<sup>§</sup> OECD Guideline for the testing of chemicals No. 430 In Vitro Skin Corrosion: Transcutaneous Electrical Resistance Test Method (TER) 2015.

<sup>¶</sup> OECD Guideline for the testing of chemicals No. 439 In Vitro Skin Irritation: Reconstructed Human Epidermis Test Method 2015.

Table 2.8.3.4 – Table summarizing the criteria in 2.8.3.3

| Packing group | Exposure time | Observation period | Effect  |
|---------------|---------------|--------------------|---|
| I             | ≤ 3 min       | ≤ 60 min           | Irreversible damage of intact skin  |
| II            | > 3 min ≤ 1 h | ≤ 14 d             | Irreversible damage of intact skin  |
| III           | > 1 h ≤ 4 h   | ≤ 14 d             | Irreversible damage of intact skin  |
| III           | –             | –                  | Corrosion rate on either steel or aluminium surfaces exceeding 6.25 mm a year at a test temperature of 55°C when tested on both materials |

## 2.8.4 Alternative packing group assignment methods for mixtures: step-wise approach

### 2.8.4.1 General provisions

2.8.4.1.1 For mixtures it is necessary to obtain or derive information that allows the criteria to be applied to the mixture for the purpose of classification and assignment of packing groups. The approach to classification and assignment of packing groups is tiered, and is dependent upon the amount of information available for the mixture itself, for similar mixtures and/or for its ingredients. The flow chart of figure 2.8.4.1 below outlines the process to be followed:

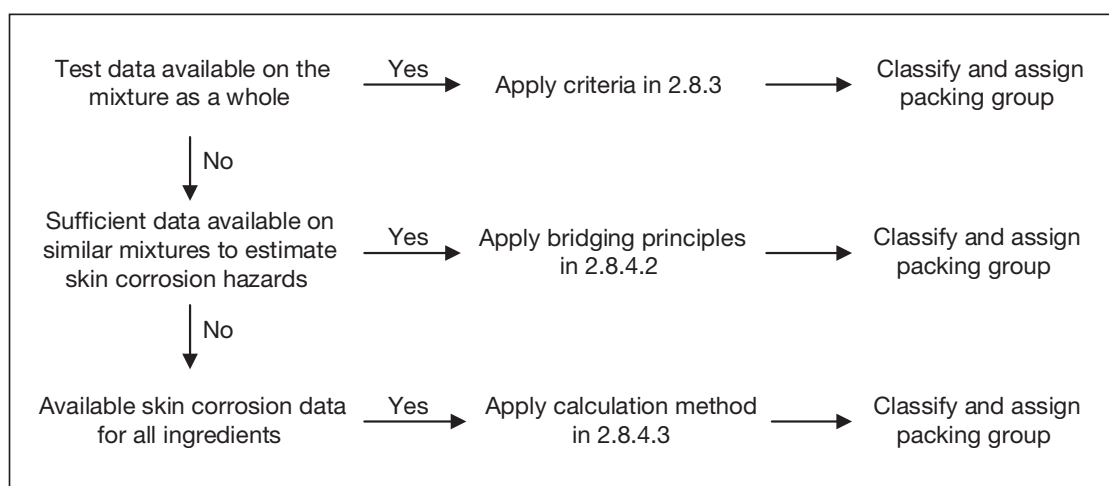

Figure 2.8.4.1 – Step-wise approach to classify and assign packing group of corrosive mixtures

### 2.8.4.2 Bridging principles

2.8.4.2.1 Where a mixture has not been tested to determine its skin corrosion potential, but there are sufficient data on both the individual ingredients and similar tested mixtures to adequately classify and assign a packing group for the mixture, these data will be used in accordance with the following bridging principles. This ensures that the classification process uses the available data to the greatest extent possible in characterizing the hazards of the mixture.

- 1 **Dilution:** If a tested mixture is diluted with a diluent which does not meet the criteria for class 8 and does not affect the packing group of other ingredients, then the new diluted mixture may be assigned to the same packing group as the original tested mixture.

**Note:** In certain cases, diluting a mixture or substance may lead to an increase in the corrosive properties. If this is the case, this bridging principle cannot be used.

- 2 **Batching:** The skin corrosion potential of a tested production batch of a mixture can be assumed to be substantially equivalent to that of another untested production batch of the same commercial product when produced by or under the control of the same manufacturer, unless there is reason to believe there is significant variation such that the skin corrosion potential of the untested batch has changed. If the latter occurs, a new classification is necessary.

- .3 *Concentration of mixtures of packing group I*: If a tested mixture meeting the criteria for inclusion in packing group I is concentrated, the more concentrated untested mixture may be assigned to packing group I without additional testing.
- .4 *Interpolation within one packing group*: For three mixtures (A, B and C) with identical ingredients, where mixtures A and B have been tested and are in the same skin corrosion packing group, and where untested mixture C has the same class 8 ingredients as mixtures A and B but has concentrations of class 8 ingredients intermediate to the concentrations in mixtures A and B, then mixture C is assumed to be in the same skin corrosion packing group as A and B.
- .5 *Substantially similar mixtures*: Given the following:
- .1 two mixtures: (A+B) and (C+B);
  - .2 the concentration of ingredient B is the same in both mixtures;
  - .3 the concentration of ingredient A in mixture (A+B) equals the concentration of ingredient C in mixture (C+B); and
  - .4 data on skin corrosion for ingredients A and C are available and substantially equivalent, i.e. they are the same skin corrosion packing group and do not affect the skin corrosion potential of B.

If mixture (A+B) or (C+B) is already classified based on test data, then the other mixture may be assigned to the same packing group.

#### 2.8.4.3 Calculation method based on the classification of the substances

- 2.8.4.3.1 Where a mixture has not been tested to determine its skin corrosion potential, nor is sufficient data available on similar mixtures, the corrosive properties of the substances in the mixture shall be considered to classify and assign a packing group.

Applying the calculation method is only allowed if there are no synergistic effects that make the mixture more corrosive than the sum of its substances. This restriction applies only if packing group II or III would be assigned to the mixture.

- 2.8.4.3.2 When using the calculation method, all class 8 ingredients present at a concentration of  $\geq 1\%$  shall be taken into account, or  $< 1\%$  if these ingredients are still relevant for classifying the mixture to be corrosive to skin.
- 2.8.4.3.3 To determine whether a mixture containing corrosive substances shall be considered a corrosive mixture and to assign a packing group, the calculation method in the flow chart in figure 2.8.4.3 shall be applied. For this calculation method, generic concentration limits apply where 1% is used in the first step for the assessment of the packing group I substances, and where 5% is used for the other steps respectively.
- 2.8.4.3.4 When a specific concentration limit (SCL) is assigned to a substance following its entry in the Dangerous Goods List or in a special provision, this limit shall be used instead of the generic concentration limits (GCL).
- 2.8.4.3.5 For this purpose, the summation formula for each step of the calculation method shall be adapted. This means that, where applicable, the generic concentration limit shall be substituted by the specific concentration limit assigned to the substance(s) (SCL<sub>i</sub>), and the adapted formula is a weighted average of the different concentration limits assigned to the different substances in the mixture:

$$\frac{PGx_1}{GCL} + \frac{PGx_2}{SCL_2} + \dots + \frac{PGx_i}{SCL_i} \geq 1$$

Where:

$PGx_i$  = concentration of substance 1, 2 . . .  $i$  in the mixture, assigned to packing group  $x$  (I, II or III)

$GCL$  = generic concentration limit

$SCL_i$  = specific concentration limit assigned to substance  $i$

The criterion for a packing group is fulfilled when the result of the calculation is  $\geq 1$ . The generic concentration limits to be used for the evaluation in each step of the calculation method are those found in figure 2.8.4.3.

Examples for the application of the above formula can be found in the note below.

**Note:** *Examples for the application of the above formula*

**Example 1:** A mixture contains one corrosive substance in a concentration of 5% assigned to packing group I without a specific concentration limit:

Calculation for packing group I:  $\frac{5}{5(GCL)} = 1 \rightarrow$  assign to class 8, packing group I.

Part 2 – Classification

2

**Example 2:** A mixture contains three substances corrosive to skin; two of them (A and B) have specific concentration limits; for the third one (C) the generic concentration limits applies. The rest of the mixture needs not to be taken into consideration.

| Substance X in the mixture and its packing group assignment within class 8 | Concentration (conc) in the mixture in % | Specific concentration limit (SCL) for packing group I | Specific concentration limit (SCL) for packing group II | Specific concentration limit (SCL) for packing group III |
|--|--|--|---|--|
| A, assigned to packing group I   | 3  | 30%  | none  | none   |
| B, assigned to packing group I   | 2  | 20%  | 10%   | none   |
| C, assigned to packing group III   | 10                                       | none   | none  | none   |

Calculation for packing group I:  $\frac{3 \text{ (conc A)}}{30 \text{ (SCL PGI)}} + \frac{2 \text{ (conc B)}}{20 \text{ (SCL PGI)}} = 0.2 < 1$

The criterion for packing group I is not fulfilled.

Calculation for packing group II:  $\frac{3 \text{ (conc A)}}{5 \text{ (GCL PGII)}} + \frac{2 \text{ (conc B)}}{10 \text{ (SCL PGII)}} = 0.8 < 1$

The criterion for packing group II is not fulfilled.

Calculation for packing group III:  $\frac{3 \text{ (conc A)}}{5 \text{ (GCL PGIII)}} + \frac{2 \text{ (conc B)}}{5 \text{ (GCL PGIII)}} + \frac{10 \text{ (conc C)}}{5 \text{ (GCL PGIII)}} = 3 \geq 1$

The criterion for packing group III is fulfilled, the mixture shall be assigned to class 8, packing group III.

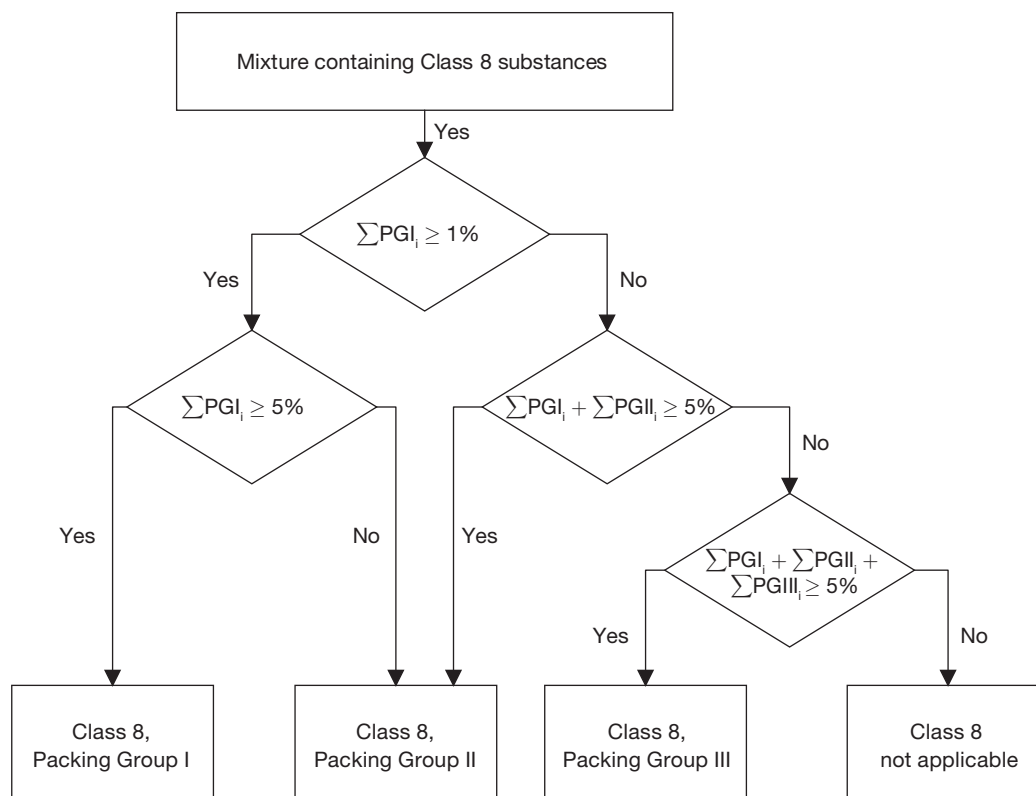

Figure 2.8.4.3 – Calculation method

### 2.8.5 Substances not accepted for transport

Chemically unstable substances of class 8 shall not be accepted for transport unless the necessary precautions have been taken to prevent the possibility of a dangerous decomposition or polymerization under normal conditions of transport. For the precautions necessary to prevent polymerization, see special provision 386 of chapter 3.3. To this end particular care shall be taken to ensure that receptacles and tanks do not contain any substances liable to promote these reactions.

## Chapter 2.9

### *Miscellaneous dangerous substances and articles (class 9) and environmentally hazardous substances*

**Note 1:** For the purposes of this Code, the environmentally hazardous substances (aquatic environment) criteria contained in this chapter apply to the classification of marine pollutants (see 2.10).

**Note 2:** Although the environmentally hazardous substances (aquatic environment) criteria apply to all hazard classes, except for class 7 (see paragraphs 2.10.2.3, 2.10.2.5 and 2.10.3.2), the criteria have been included in this chapter.

#### 2.9.1 Definition

2.9.1.1 *Class 9 substances and articles (miscellaneous dangerous substances and articles)* are substances and articles which, during transport, present a danger not covered by other classes.

#### 2.9.2 Assignment to class 9

2.9.2.1 Class 9 includes, inter alia:

- .1 substances and articles not covered by other classes which experience has shown, or may show, to be of such a dangerous character that the provisions of part A of chapter VII of SOLAS, as amended, shall apply.
- .2 substances not subject to the provisions of part A in chapter VII of the aforementioned Convention, but to which the provisions of Annex III of MARPOL, as amended, apply.

2.9.2.2 The substances and articles of class 9 are subdivided as follows:

##### Substances which, on inhalation as fine dust, may endanger health

2212 ASBESTOS, AMPHIBOLE (amosite, tremolite, actinolite, anthophyllite, crocidolite)

2590 ASBESTOS, CHRYSOTILE

##### Substances evolving flammable vapour

2211 POLYMERIC BEADS, EXPANDABLE, evolving flammable vapour

3314 PLASTICS MOULDING COMPOUND in dough, sheet or extruded rope form evolving flammable vapour

##### Lithium batteries

3090 LITHIUM METAL BATTERIES (including lithium alloy batteries)

3091 LITHIUM METAL BATTERIES CONTAINED IN EQUIPMENT (including lithium alloy batteries) or

3091 LITHIUM METAL BATTERIES PACKED WITH EQUIPMENT (including lithium alloy batteries)

3480 LITHIUM ION BATTERIES (including lithium ion polymer batteries)

3481 LITHIUM ION BATTERIES CONTAINED IN EQUIPMENT (including lithium ion polymer batteries) or

3481 LITHIUM ION BATTERIES PACKED WITH EQUIPMENT (including lithium ion polymer batteries)

3536 LITHIUM BATTERIES INSTALLED IN CARGO TRANSPORT UNIT lithium ion batteries or lithium metal batteries

**Note:** See 2.9.4.

■ **Sodium ion batteries**

- 3551 SODIUM ION BATTERIES with organic electrolyte
- 3552 SODIUM ION BATTERIES CONTAINED IN EQUIPMENT or SODIUM ION BATTERIES PACKED WITH EQUIPMENT, with organic electrolyte”.

**Capacitors**

- 3499 CAPACITOR, ELECTRIC DOUBLE LAYER (with an energy storage capacity greater than 0.3 Wh)
- 3508 CAPACITOR, ASYMMETRIC (with an energy storage capacity greater than 0.3 Wh)

**Life-saving appliances**

- 2990 LIFE-SAVING APPLIANCES, SELF-INFLATING
- 3072 LIFE-SAVING APPLIANCES, NOT SELF-INFLATING containing dangerous goods as equipment
- 3268 SAFETY DEVICES, electrically initiated
- 3559 FIRE SUPPRESSANT DISPERSING DEVICES

**Substances and articles which, in the event of fire, may form dioxins**

This group of substances includes:

- 2315 POLYCHLORINATED BIPHENYLS, LIQUID
- 3432 POLYCHLORINATED BIPHENYLS, SOLID
- 3151 POLYHALOGENATED BIPHENYLS, LIQUID or
- 3151 HALOGENATED MONOMETHYLDIPHENYLMETHANES, LIQUID or
- 3151 POLYHALOGENATED TERPHENYLS, LIQUID
- 3152 POLYHALOGENATED BIPHENYLS, SOLID or
- 3152 HALOGENATED MONOMETHYLDIPHENYLMETHANES, SOLID or
- 3152 POLYHALOGENATED TERPHENYLS, SOLID

Examples of articles are transformers, condensers and apparatus containing those substances.

**Substances transported or offered for transport at elevated temperatures**

- 3257 ELEVATED TEMPERATURE LIQUID, N.O.S., at or above 100°C and below its flashpoint (including molten metal, molten salts, etc.)
- 3258 ELEVATED TEMPERATURE SOLID, N.O.S., at or above 240°C

**Environmentally hazardous substances**

- 3077 ENVIRONMENTALLY HAZARDOUS SUBSTANCE, SOLID, N.O.S.
- 3082 ENVIRONMENTALLY HAZARDOUS SUBSTANCE, LIQUID, N.O.S.

These entries are used for substances and mixtures which are dangerous to the aquatic environment that do not meet the classification criteria of any other class or another substance within class 9. These entries may also be used for wastes not otherwise subject to the provisions of this Code but which are covered under the Basel Convention on the Control of Transboundary Movements of Hazardous Wastes and their Disposal and for substances designated to be environmentally hazardous substances by the competent authority of the country of origin, transit or destination which do not meet the criteria for an environmentally hazardous substance according to the provisions of this Code or for any other hazard class. The criteria for substances which are hazardous to the aquatic environment are given in section 2.9.3.

**Genetically modified microorganisms (GMMOs) and genetically modified organisms (GMOs)**

- 3245 GENETICALLY MODIFIED MICROORGANISMS or
- 3245 GENETICALLY MODIFIED ORGANISMS

GMMOs and GMOs which do not meet the definition of toxic substances (see 2.6.2) or infectious substances (see 2.6.3) shall be assigned to UN 3245.



## Part 2 – Classification

GMMOs or GMOs are not subject to the provisions of this Code when authorized for use by the competent authorities of the countries of origin, transit and destination.

- Pharmaceutical products (such as vaccines) that are packed in a form ready to be administered, including those in clinical trials, and that contain GMMOs or GMOs are not subject to this Code.

Genetically modified live animals shall be transported under terms and conditions of the competent authorities of the countries of origin and destination.

**Ammonium nitrate based fertilizers**

2071 AMMONIUM NITRATE BASED FERTILIZER

Solid ammonium nitrate based fertilizers shall be classified in accordance with the procedure as set out in the *Manual of Tests and Criteria*, part III, section 39.

**Other substances or articles presenting a danger during transport, but not meeting the definitions of another class:**

- 1841 ACETALDEHYDE AMMONIA
- 1845 CARBON DIOXIDE, SOLID (DRY ICE)
- 1931 ZINC DITHIONITE (ZINC HYDROSULPHITE)
- 1941 DIBROMODIFLUOROMETHANE
- 1990 BENZALDEHYDE
- 2216 FISH MEAL (FISH SCRAP), STABILIZED
- 2807 MAGNETIZED MATERIAL
- 2969 CASTOR BEANS or
- 2969 CASTOR MEAL or
- 2969 CASTOR POMACE or
- 2969 CASTOR FLAKE
- 3166 VEHICLE, FLAMMABLE GAS POWERED or
- 3166 VEHICLE, FLAMMABLE LIQUID POWERED or
- 3166 VEHICLE, FUEL CELL, FLAMMABLE GAS POWERED or
- 3166 VEHICLE, FUEL CELL, FLAMMABLE LIQUID POWERED
- 3171 BATTERY-POWERED VEHICLE or
- 3171 BATTERY-POWERED EQUIPMENT
- 3316 CHEMICAL KIT or
- 3316 FIRST AID KIT
- 3334 AVIATION REGULATED LIQUID, N.O.S.
- 3335 AVIATION REGULATED SOLID, N.O.S.
- 3359 FUMIGATED CARGO TRANSPORT UNIT
- 3363 DANGEROUS GOODS IN ARTICLES or
- 3363 DANGEROUS GOODS IN MACHINERY or
- 3363 DANGEROUS GOODS IN APPARATUS
- 3496 BATTERIES, NICKEL-METAL HYDRIDE
- 3509 PACKAGINGS, DISCARDED, EMPTY, UNCLEARED
- 3530 ENGINE, INTERNAL COMBUSTION or
- 3530 MACHINERY, INTERNAL COMBUSTION
- 3548 ARTICLES CONTAINING MISCELLANEOUS DANGEROUS GOODS N.O.S.
- 3556 VEHICLE, LITHIUM ION BATTERY POWERED
- 3557 VEHICLE, LITHIUM METAL BATTERY POWERED
- 3558 VEHICLE, SODIUM ION BATTERY POWERED

## 2.9.3 Environmentally hazardous substances (aquatic environment)

### 2.9.3.1 General definitions

2.9.3.1.1 Environmentally hazardous substances include, inter alia, liquid or solid substances pollutant to the aquatic environment and solutions and mixtures of such substances (such as preparations and wastes).

For the purposes of this section,

*Substance* means chemical elements and their compounds in the natural state or obtained by any production process, including any additive necessary to preserve the stability of the product and any impurities deriving from the process used, but excluding any solvent which may be separated without affecting the stability of the substance or changing its composition.

2.9.3.1.2 The aquatic environment may be considered in terms of the aquatic organisms that live in the water, and the aquatic ecosystem of which they are part.\* The basis, therefore, of the identification of hazard is the aquatic toxicity of the substance or mixture, although this may be modified by further information on the degradation and bioaccumulation behaviour.

2.9.3.1.3 While the following classification procedure is intended to apply to all substances and mixtures, it is recognized that in some cases, e.g. metals or poorly soluble inorganic compounds, special guidance will be necessary.†

2.9.3.1.4 The following definitions apply for acronyms or terms used in this section:

|   |   |
|---|---|
| BCF   | bioconcentration factor;  |
| BOD   | biochemical oxygen demand;  |
| COD   | chemical oxygen demand;   |
| GLP   | good laboratory practices;  |
| EC <sub>x</sub>                             | the concentration associated with x% response;  |
| EC <sub>50</sub>                            | the effective concentration of substance that causes 50% of the maximum response;   |
| ErC <sub>50</sub>                           | EC <sub>50</sub> in terms of reduction of growth;   |
| K <sub>ow</sub>                             | octanol/water partition coefficient;  |
| LC <sub>50</sub> (50% lethal concentration) | the concentration of a substance in water which causes the death of 50% (one half) in a group of test animals;  |
| L(E)C <sub>50</sub>                         | LC <sub>50</sub> or EC <sub>50</sub> ;  |
| NOEC (no observed effect concentration)     | the test concentration immediately below the lowest tested concentration with statistically significant adverse effect. The NOEC has no statistically significant adverse effect compared to the control; |
| OECD Test Guidelines                        | Test guidelines published by the Organization for Economic Co-operation and Development (OECD).   |

### 2.9.3.2 Definitions and data requirements

2.9.3.2.1 The basic elements for classification of environmentally hazardous substances (aquatic environment) are:

- .1 acute aquatic toxicity;
- .2 chronic aquatic toxicity;
- .3 potential for or actual bioaccumulation; and
- .4 degradation (biotic or abiotic) for organic chemicals;

2.9.3.2.2 While data from internationally harmonized test methods are preferred, in practice, data from national methods may also be used where they are considered as equivalent. In general, it has been agreed that freshwater and marine species toxicity data can be considered as equivalent data and are preferably to be derived using OECD Test Guidelines or equivalent according to the principles of good laboratory practices (GLP). Where such data are not available, classification shall be based on the best available data.

\* This does not address aquatic pollutants for which there may be a need to consider effects beyond the aquatic environment such as the impacts on human health, etc.

† This can be found in annex 10 of the GHS.

## Part 2 – Classification

**2.9.3.2.3** *Acute aquatic toxicity* means the intrinsic property of a substance to be injurious to an organism in a short-term aquatic exposure to that substance.

*Acute (short-term) hazard*, for classification purposes, means the hazard of a chemical caused by its acute toxicity to an organism during short-term aquatic exposure to that chemical.

Acute aquatic toxicity shall normally be determined using a fish 96 h LC<sub>50</sub> (OECD Test Guideline 203 or equivalent), a crustacea species 48 h EC<sub>50</sub> (OECD Test Guideline 202 or equivalent) and/or an algal species 72 or 96 h EC<sub>50</sub> (OECD Test Guideline 201 or equivalent). These species are considered as surrogate for all aquatic organisms and data on other species such as Lemna may also be considered if the test methodology is suitable.

**2.9.3.2.4** *Chronic aquatic toxicity* means the intrinsic property of a substance to cause adverse effects to aquatic organisms during aquatic exposures which are determined in relation to the life cycle of the organism.

*Long-term hazard*, for classification purposes, means the hazard of a chemical caused by its chronic toxicity following long-term exposure in the aquatic environment.

Chronic toxicity data are less available than acute data and the range of testing procedures less standardized. Data generated according to the OECD Test Guidelines 210 (Fish Early Life Stage) or 211 (Daphnia Reproduction) and 201 (Algal Growth Inhibition) may be accepted. Other validated and internationally accepted tests may also be used. The NOECs or other equivalent EC<sub>x</sub> shall be used.

**2.9.3.2.5** *Bioaccumulation* means net result of uptake, transformation and elimination of a substance in an organism due to all routes of exposure (i.e. air, water, sediment/soil and food).

The potential for bioaccumulation shall normally be determined by using the octanol/water partition coefficient, usually reported as a log K<sub>ow</sub> determined according to OECD Test Guidelines 107, 117 or 123. While this represents a potential to bioaccumulate, an experimentally determined bioconcentration factor (BCF) provides a better measure and shall be used in preference when available. A BCF shall be determined according to OECD Test Guideline 305.

**2.9.3.2.6** *Degradation* means the decomposition of organic molecules to smaller molecules and eventually to carbon dioxide, water and salts.

Environmental degradation may be biotic or abiotic (e.g. hydrolysis) and the criteria used reflect this fact. Ready biodegradation is most easily defined using the biodegradability tests (A to F) of OECD Test Guidelines 301. A pass level in these tests may be considered as indicative of rapid degradation in most environments. These are freshwater tests and thus the use of the results from OECD Test Guideline 306, which is more suitable for marine environments, has also been included. Where such data are not available, a BOD(5 days)/COD ratio  $\geq 0.5$  is considered as indicative of rapid degradation. Abiotic degradation such as hydrolysis, primary degradation, both abiotic and biotic, degradation in non-aquatic media and proven rapid degradation in the environment may all be considered in defining rapid degradability.\*

Substances are considered rapidly degradable in the environment if the following criteria are met:

- .1 In 28-day ready biodegradation studies, the following levels of degradation are achieved:
  - .1 tests based on dissolved organic carbon: 70%;
  - .2 tests based on oxygen depletion or carbon dioxide generation: 60% of theoretical maxima.

These levels of biodegradation shall be achieved within 10 days of the start of degradation which point is taken as the time when 10% of the substance has been degraded, unless the substance is identified as a complex, multi-component substance with structurally similar constituents. In this case, and where there is sufficient justification, the 10-day window condition may be waived and the pass level applied at 28 days;†

- .2 in those cases where only BOD and COD data are available, when the ratio of BOD<sub>5</sub>/COD is  $\geq 0.5$ ; or
- .3 if other convincing scientific evidence is available to demonstrate that the substance or mixture can be degraded (biotically and/or abiotically) in the aquatic environment to a level above 70% within a 28-day period.

\* Special guidance on data interpretation is provided in chapter 4.1 and annex 9 of the GHS.

† See chapter 4.1 and annex 9, paragraph A9.4.2.2.3 of the GHS.

**2.9.3.3 Substance classification categories and criteria**

**2.9.3.3.1** Substances shall be classified as “environmentally hazardous substances (aquatic environment)”, if they satisfy the criteria for Acute 1, Chronic 1 or Chronic 2, according to table 2.9.1. These criteria describe in detail the classification categories. They are diagrammatically summarized in table 2.9.2.

**Table 2.9.1 – Categories for substances hazardous to the aquatic environment (see note 1)**

**(a) Acute (short-term) aquatic hazard**

|   |                       |
|---|-----------------------|
| <b>Category: Acute 1</b> (see note 2)                             |                       |
| 96 hr LC <sub>50</sub> (for fish)                                 | ≤ 1 mg/L and/or       |
| 48 hr EC <sub>50</sub> (for crustacea)                            | ≤ 1 mg/L and/or       |
| 72 or 96 hr ErC <sub>50</sub> (for algae or other aquatic plants) | ≤ 1 mg/L (see note 3) |

**(b) Long-term aquatic hazard (see also figure 2.9.1)**

(i) Non-rapidly degradable substances (see note 4) for which there are adequate chronic toxicity data available

|   |                   |
|---|-------------------|
| <b>Category: Chronic 1</b> (see note 2)                             |                   |
| Chronic NOEC or EC <sub>x</sub> (for fish)                          | ≤ 0.1 mg/L and/or |
| Chronic NOEC or EC <sub>x</sub> (for crustacea)                     | ≤ 0.1 mg/L and/or |
| Chronic NOEC or EC <sub>x</sub> (for algae or other aquatic plants) | ≤ 0.1 mg/L        |
| <b>Category: Chronic 2</b>  |                   |
| Chronic NOEC or EC <sub>x</sub> (for fish)                          | ≤ 1 mg/L and/or   |
| Chronic NOEC or EC <sub>x</sub> (for crustacea)                     | ≤ 1 mg/L and/or   |
| Chronic NOEC or EC <sub>x</sub> (for algae or other aquatic plants) | ≤ 1 mg/L          |

(ii) Rapidly degradable substances for which there are adequate chronic toxicity data available

|   |                    |
|---|--------------------|
| <b>Category: Chronic 1</b> (see note 2)                             |                    |
| Chronic NOEC or EC <sub>x</sub> (for fish)                          | ≤ 0.01 mg/L and/or |
| Chronic NOEC or EC <sub>x</sub> (for crustacea)                     | ≤ 0.01 mg/L and/or |
| Chronic NOEC or EC <sub>x</sub> (for algae or other aquatic plants) | ≤ 0.01 mg/L        |
| <b>Category: Chronic 2</b>  |                    |
| Chronic NOEC or EC <sub>x</sub> (for fish)                          | ≤ 0.1 mg/L and/or  |
| Chronic NOEC or EC <sub>x</sub> (for crustacea)                     | ≤ 0.1 mg/L and/or  |
| Chronic NOEC or EC <sub>x</sub> (for algae or other aquatic plants) | ≤ 0.1 mg/L         |

(iii) Substances for which adequate chronic toxicity data are not available

|   |  |
|---|--|
| <b>Category: Chronic 1</b> (see note 2)   |  |
| 96 hr LC <sub>50</sub> (for fish)   | ≤ 1 mg/L and/or                          |
| 48 hr EC <sub>50</sub> (for crustacea)  | ≤ 1 mg/L and/or                          |
| 72 or 96 hr ErC <sub>50</sub> (for algae or other aquatic plants)   | ≤ 1 mg/L (see note 3)                    |
| and the substance is not rapidly degradable and/or the experimentally determined BCF is ≥ 500<br>(or, if absent, the log K <sub>ow</sub> ≥ 4) (see notes 4 and 5) |  |
| <b>Category: Chronic 2</b>  |  |
| 96 hr LC <sub>50</sub> (for fish)   | > 1 but ≤ 10 mg/L and/or                 |
| 48 hr EC <sub>50</sub> (for crustacea)  | > 1 but ≤ 10 mg/L and/or                 |
| 72 or 96 hr ErC <sub>50</sub> (for algae or other aquatic plants)   | > 1 but ≤ 10 mg/L and/or<br>(see note 3) |
| and the substance is not rapidly degradable and/or the experimentally determined BCF is ≥ 500<br>(or, if absent, the log K <sub>ow</sub> ≥ 4) (see notes 4 and 5) |  |

**Note 1:** The organisms fish, crustacea and algae are tested as surrogate species covering a range of trophic levels and taxa, and the test methods are highly standardized. Data on other organisms may also be considered, however, provided they represent equivalent species and test endpoints.

**Note 2:** When classifying substances as Acute 1 and/or Chronic 1 it is necessary at the same time to indicate an appropriate M factor (see 2.9.3.4.6.4) to apply the summation method.

**Note 3:** Where the algal toxicity  $ErC_{50}$  (=  $EC_{50}$  (growth rate)) falls more than 100 times below the next most sensitive species and results in a classification based solely on this effect, consideration shall be given to whether this toxicity is representative of the toxicity to aquatic plants. Where it can be shown that this is not the case, professional judgment shall be used in deciding if classification shall be applied. Classification shall be based on the  $ErC_{50}$ . In circumstances where the basis of the  $EC_{50}$  is not specified and no  $ErC_{50}$  is recorded, classification shall be based on the lowest  $EC_{50}$  available.

**Note 4:** Lack of rapid degradability is based on either a lack of ready biodegradability or other evidence of lack of rapid degradation. When no useful data on degradability are available, either experimentally determined or estimated data, the substance shall be regarded as not rapidly degradable.

**Note 5:** Potential to bioaccumulate, based on an experimentally derived  $BCF \geq 500$  or, if absent, a  $\log K_{ow} \geq 4$  provided  $\log K_{ow}$  is an appropriate descriptor for the bioaccumulation potential of the substance. Measured  $\log K_{ow}$  values take precedence over estimated values and measured BCF values take precedence over  $\log K_{ow}$  values.

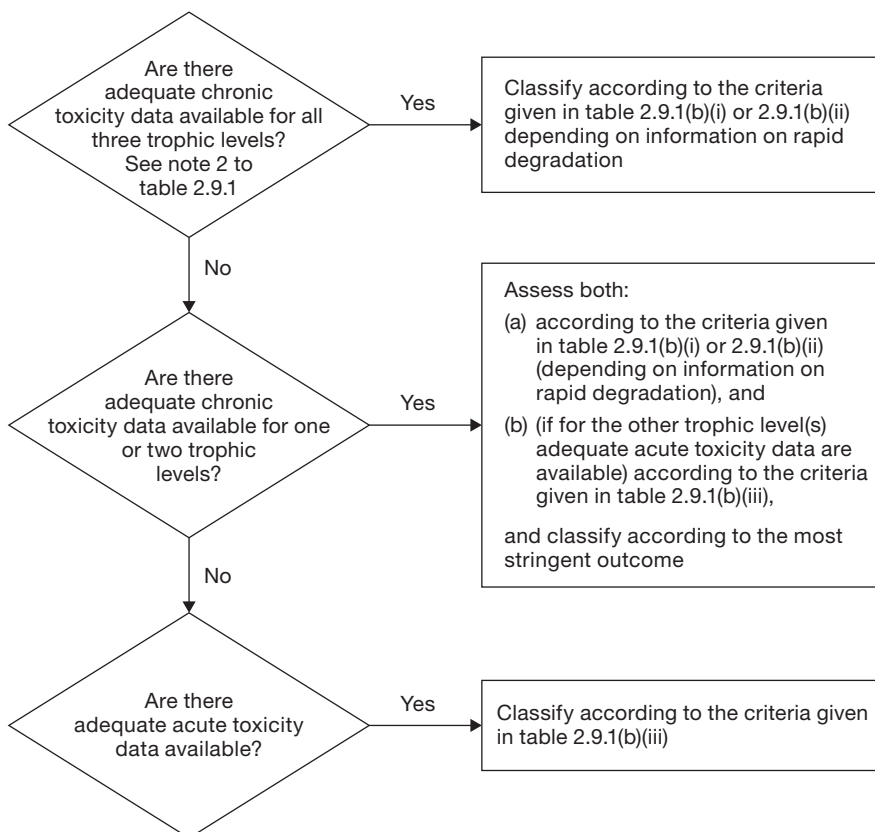

Figure 2.9.1 – Categories for substances long-term hazardous to the aquatic environment

2.9.3.3.2 The classification scheme in table 2.9.2 below summarizes the classification criteria for substances.

Table 2.9.2 – Classification scheme for substances hazardous to the aquatic environment

| Classification categories    |   |   |   |
|------------------------------|---|---|---|
| Acute hazard<br>(see note 1) | Long-term hazard<br>(see note 2)                  |   |   |
|                              | Adequate chronic toxicity data available          |   | Adequate chronic toxicity data not available<br>(see note 1)  |
|                              | Non-rapidly degradable substances<br>(see note 3) | Rapidly degradable substances<br>(see note 3) |   |
| Category: Acute 1            | Category: Chronic 1                               | Category: Chronic 1                           | Category: Chronic 1   |
| $L(E)C_{50} \leq 1.00$       | NOEC or $EC_x \leq 0.1$                           | NOEC or $EC_x \leq 0.01$                      | $L(E)C_{50} \leq 1.00$ and lack of rapid degradability and/or $BCF \geq 500$ or, if absent, $\log K_{ow} \geq 4$        |
|                              | Category: Chronic 2                               | Category: Chronic 2                           | Category: Chronic 2   |
|                              | $0.1 < NOEC$ or $EC_x \leq 1$                     | $0.01 < NOEC$ or $EC_x \leq 0.1$              | $1.00 < L(E)C_{50} \leq 10.0$ and lack of rapid degradability and/or $BCF \geq 500$ or, if absent, $\log K_{ow} \geq 4$ |

**Note 1:** Acute toxicity band based on  $L(E)C_{50}$  values in mg/L for fish, crustacea and/or algae or other aquatic plants (or Quantitative Structure Activity Relationships (QSAR) estimation if no experimental data).\*

**Note 2:** Substances are classified in the various chronic categories unless there are adequate chronic toxicity data available for all three trophic levels above the water solubility or above 1 mg/L. (“Adequate” means that the data sufficiently cover the endpoint of concern. Generally this would mean measured test data, but in order to avoid unnecessary testing it can on a case by case basis also be estimated data, e.g. (Q)SAR, or for obvious cases expert judgment).

**Note 3:** Chronic toxicity band based on NOEC or equivalent  $EC_x$  values in mg/L for fish or crustacea or other recognized measures for chronic toxicity.

#### 2.9.3.4 Mixtures classification categories and criteria

2.9.3.4.1 The classification system for mixtures covers the classification categories which are used for substances, meaning categories Acute 1 and Chronic 1 and 2. In order to make use of all available data for purposes of classifying the aquatic environmental hazards of the mixture, the following assumption is made and is applied where appropriate:

The “relevant ingredients” of a mixture are those which are present in a concentration equal to or greater than 0.1% (by mass) for ingredients classified as Acute and/or Chronic 1 and equal to or greater than 1% for other ingredients, unless there is a presumption (e.g. in the case of highly toxic ingredients) that an ingredient present at less than 0.1% can still be relevant for classifying the mixture for aquatic environmental hazards.

2.9.3.4.2 The approach for classification of aquatic environmental hazards is tiered, and is dependent upon the type of information available for the mixture itself and for its ingredients. Elements of the tiered approach include:

- .1 classification based on tested mixtures;
- .2 classification based on bridging principles;
- .3 the use of “summation of classified ingredients” and/or an “additivity formula”.

Figure 2.9.2 outlines the process to be followed.

\* Special guidance is provided in chapter 4.1, paragraph 4.1.2.13 and annex 9, section A9.6 of the GHS.

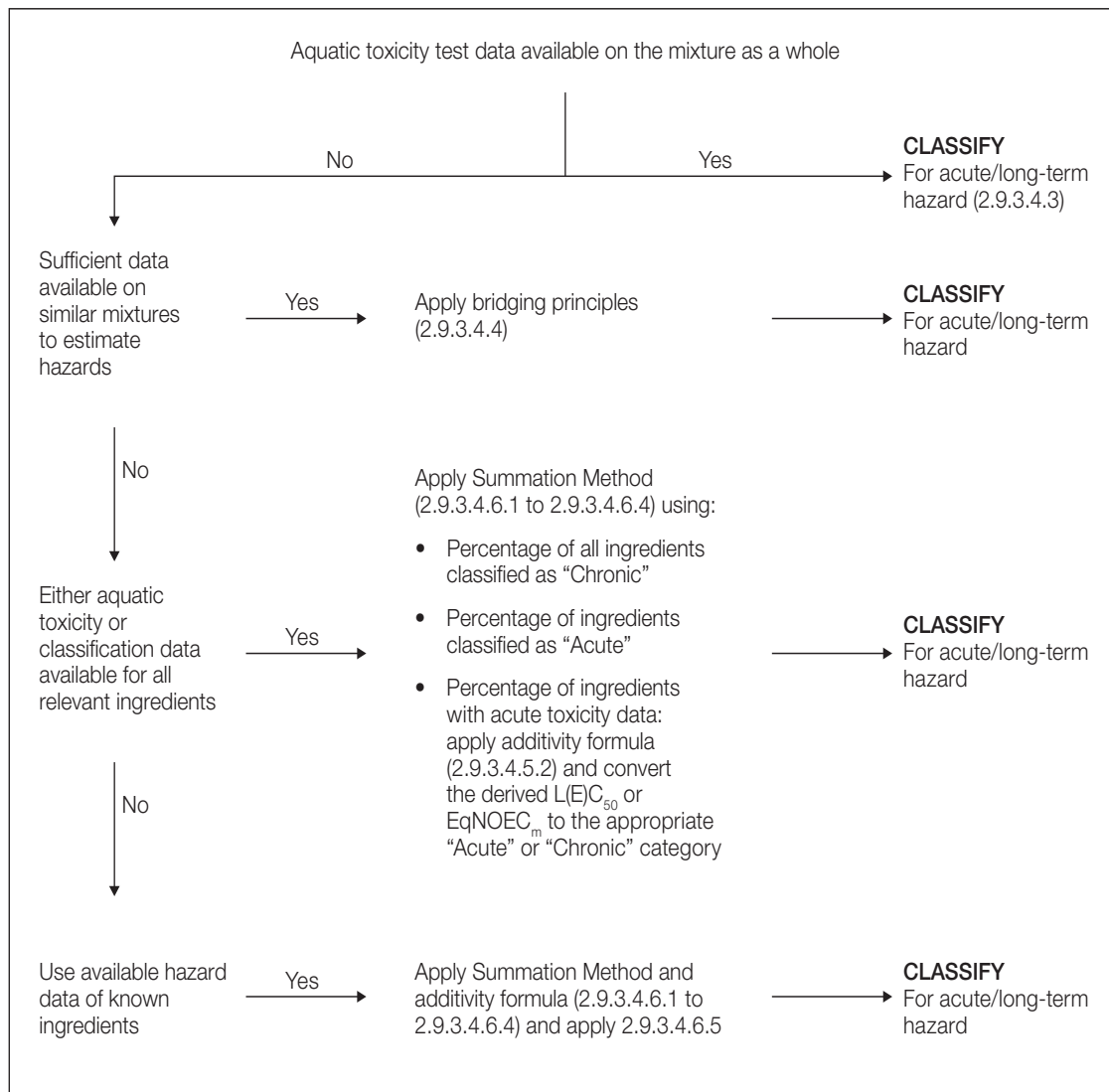

Figure 2.9.2 – Tiered approach to classification of mixtures for acute and long-term aquatic environmental hazards

2.9.3.4.3 Classification of mixtures when toxicity data are available for the complete mixture

2.9.3.4.3.1 When the mixture as a whole has been tested to determine its aquatic toxicity, this information shall be used for classifying the mixture according to the criteria that have been agreed for substances. The classification is normally based on the data for fish, crustacea and algae/plants (see 2.9.3.2.3 and 2.9.3.2.4). When adequate acute or chronic data for the mixture as a whole are lacking, “bridging principles” or “summation method” shall be applied (see 2.9.3.4.4 to 2.9.3.4.6).

2.9.3.4.3.2 The long-term hazard classification of mixtures requires additional information on degradability and in certain cases bioaccumulation. There are no degradability and bioaccumulation data for mixtures as a whole. Degradability and bioaccumulation tests for mixtures are not used as they are usually difficult to interpret, and such tests may be meaningful only for single substances.

2.9.3.4.3.3 Classification for category Acute 1

(a) When there are adequate acute toxicity test data ( $LC_{50}$  or  $EC_{50}$ ) available for the mixture as a whole showing  $L(E)C_{50} \leq 1$  mg/L:

Classify the mixture as Acute 1 in accordance with table 2.9.1 (a);

(b) When there are acute toxicity test data ( $LC_{50}(s)$  or  $EC_{50}(s)$ ) available for the mixture as a whole showing  $L(E)C_{50}(s) > 1$  mg/L, or above the water solubility:

No need to classify for acute hazard under this Code.



**2.9.3.4.3.4 Classification for categories Chronic 1 and 2**

- (a) When there are adequate chronic toxicity data ( $EC_x$  or NOEC) available for the mixture as a whole showing  $EC_x$  or NOEC of the tested mixture  $\leq 1$  mg/L:
- (i) classify the mixture as Chronic 1 or 2 in accordance with table 2.9.1 (b)(ii) (rapidly degradable) if the available information allows the conclusion that all relevant ingredients of the mixture are rapidly degradable;  
**Note:** In this situation, when  $EC_x$  or NOEC of the tested mixture  $> 0.1$  mg/L, there is no need to classify for long-term hazard under these provisions.
  - (ii) classify the mixture as Chronic 1 or 2 in all other cases in accordance with table 2.9.1 (b)(i) (non-rapidly degradable);
- (b) When there are adequate chronic toxicity data ( $EC_x$  or NOEC) available for the mixture as a whole showing  $EC_x(s)$  or NOEC(s) of the tested mixture  $> 1$  mg/L or above the water solubility:  
No need to classify for long-term hazard under this Code.

**2.9.3.4.4 Classification of mixtures when toxicity data are not available for the complete mixture: bridging principles**

**2.9.3.4.4.1** Where the mixture itself has not been tested to determine its aquatic environmental hazard, but there are sufficient data on the individual ingredients and similar tested mixtures to adequately characterize the hazards of the mixture, these data shall be used in accordance with the following agreed bridging rules. This ensures that the classification process uses the available data to the greatest extent possible in characterizing the hazards of the mixture without the necessity for additional testing in animals.

**2.9.3.4.4.2 Dilution**

**2.9.3.4.4.2.1** Where a new mixture is formed by diluting a tested mixture or a substance with a diluent which has an equivalent or lower aquatic hazard classification than the least toxic original ingredient and which is not expected to affect the aquatic hazards of other ingredients, then the resulting mixture shall be classified as equivalent to the original tested mixture or substance. Alternatively, the method explained in 2.9.3.4.5 may be applied.

**2.9.3.4.4.2.2** If a mixture is formed by diluting another classified mixture or a substance with water or other totally non-toxic material, the toxicity of the mixture shall be calculated from the original mixture or substance.

**2.9.3.4.4.3 Batching**

**2.9.3.4.4.3.1** The aquatic hazard classification of a tested production batch of a mixture shall be assumed to be substantially equivalent to that of another untested production batch of the same commercial product when produced by or under the control of the same manufacturer, unless there is reason to believe there is significant variation such that the aquatic hazard classification of the untested batch has changed. If the latter occurs, new classification is necessary.

**2.9.3.4.4.4 Concentration of mixtures which are classified with the most severe classification categories (Chronic 1 and Acute 1)**

**2.9.3.4.4.4.1** If a tested mixture is classified as Chronic 1 and/or Acute 1, and the ingredients of the mixture which are classified as Chronic 1 and/or Acute 1 are further concentrated, the more concentrated untested mixture shall be classified with the same classification category as the original tested mixture without additional testing.

**2.9.3.4.4.5 Interpolation within one toxicity category**

**2.9.3.4.4.5.1** For three mixtures (A, B and C) with identical ingredients, where mixtures A and B have been tested and are in the same toxicity category, and where untested mixture C has the same toxicologically active ingredients as mixtures A and B but has concentrations of toxicologically active ingredients intermediate to the concentrations in mixtures A and B, then mixture C is assumed to be in the same category as A and B.

**2.9.3.4.4.6 Substantially similar mixtures**

**2.9.3.4.4.6.1** Given the following:

- (a) Two mixtures:
  - (i) A + B
  - (ii) C + B
- (b) The concentration of ingredient B is essentially the same in both mixtures;
- (c) The concentration of ingredient A in mixture (i) equals that of ingredient C in mixture (ii);
- (d) Data on aquatic hazards for A and C are available and are substantially equivalent, i.e. they are in the same hazard category and are not expected to affect the aquatic toxicity of B.



## Part 2 – Classification

If mixture (i) or (ii) is already classified based on test data, then the other mixture can be assigned the same hazard category.

#### 2.9.3.4.5 Classification of mixtures when toxicity data are available for all ingredients or only for some ingredients of the mixture

2.9.3.4.5.1 The classification of a mixture shall be based on summation of the concentrations of its classified ingredients. The percentage of ingredients classified as Acute or Chronic will feed straight into the summation method. Details of the summation method are described in 2.9.3.4.6.1 to 2.9.3.4.6.4.1.

2.9.3.4.5.2 Mixtures may be made of a combination of both ingredients that are classified (as Acute 1 and/or Chronic 1, 2) and those for which adequate toxicity test data are available. When adequate toxicity data are available for more than one ingredient in the mixture, the combined toxicity of those ingredients shall be calculated using the following additivity formulas (a) or (b), depending on the nature of the toxicity data:

(a) Based on acute aquatic toxicity:

$$\frac{\sum C_i}{L(E)C_{50m}} = \sum_n \frac{C_i}{L(E)C_{50i}}$$

where:  $C_i$  = concentration of ingredient  $i$  (mass percentage);

$L(E)C_{50i}$  =  $LC_{50}$  or  $EC_{50}$  for ingredient  $i$  (mg/L);

$n$  = number of ingredients, and  $i$  is running from 1 to  $n$ ; and

$L(E)C_{50m}$  =  $L(E)C_{50}$  of the part of the mixture with test data

The calculated toxicity shall be used to assign that portion of the mixture an acute hazard category which is then subsequently used in applying the summation method;

(b) Based on chronic aquatic toxicity:

$$\frac{\sum C_i + \sum C_j}{EqNOEC_m} = \sum_n \frac{C_i}{NOEC_i} + \sum_n \frac{C_j}{0.1 \times NOEC_j}$$

where:  $C_i$  = concentration of ingredient  $i$  (mass percentage) covering the rapidly degradable ingredients;

$C_j$  = concentration of ingredient  $j$  (mass percentage) covering the non-rapidly degradable ingredients;

$NOEC_i$  = NOEC (or other recognized measures for chronic toxicity) for ingredient  $i$  covering the rapidly degradable ingredients, in mg/L;

$NOEC_j$  = NOEC (or other recognized measures for chronic toxicity) for ingredient  $j$  covering the non-rapidly degradable ingredients, in mg/L;

$n$  = number of ingredients, and  $i$  and  $j$  are running from 1 to  $n$ ;

$EqNOEC_m$  = equivalent NOEC of the part of the mixture with test data;

The equivalent toxicity thus reflects the fact that non-rapidly degrading substances are classified one hazard category level more "severe" than rapidly degrading substances.

The calculated equivalent toxicity shall be used to assign that portion of the mixture a long-term hazard category, in accordance with the criteria for rapidly degradable substances (table 2.9.1 (b)(ii)), which is then subsequently used in applying the summation method.

2.9.3.4.5.3 When applying the additivity formula for part of the mixture, it is preferable to calculate the toxicity of this part of the mixture using for each ingredient toxicity values that relate to the same taxonomic group (i.e. fish, crustacea or algae) and then to use the highest toxicity (lowest value) obtained (i.e. use the most sensitive of the three groups). However, when toxicity data for each ingredient are not available in the same taxonomic group, the toxicity value of each ingredient shall be selected in the same manner that toxicity values are selected for the classification of substances, i.e. the higher toxicity (from the most sensitive test organism) is used. The calculated acute and chronic toxicity shall then be used to classify this part of the mixture as Acute 1 and/or Chronic 1 or 2 using the same criteria described for substances.

2.9.3.4.5.4 If a mixture is classified in more than one way, the method yielding the more conservative result shall be used.

**2.9.3.4.6 Summation method****2.9.3.4.6.1 Classification procedure**

**2.9.3.4.6.1.1** In general a more severe classification for mixtures overrides a less severe classification, e.g. a classification with Chronic 1 overrides a classification with Chronic 2. As a consequence the classification procedure is already completed if the results of the classification is Chronic 1. A more severe classification than Chronic 1 is not possible; therefore, it is not necessary to pursue the classification procedure further.

**2.9.3.4.6.2 Classification for category Acute 1**

**2.9.3.4.6.2.1** First, all ingredients classified as Acute 1 are considered. If the sum of the concentrations (in %) of these ingredients is greater than or equal to 25% the whole mixture shall be classified as Acute 1. If the result of the calculation is a classification of the mixture as Acute 1, the classification process is completed.

**2.9.3.4.6.2.2** The classification of mixtures for acute hazards based on this summation of the concentrations of classified ingredients is summarized in table 2.9.3 below.

**Table 2.9.3 – Classification of a mixture for acute hazards based on summation of the concentrations of classified ingredients**

| Sum of the concentrations (in %) of ingredients classified as: | Mixture is classified as: |
|--|---------------------------|
| Acute 1 $\times M^* \geq 25\%$                                 | Acute 1                   |

\* For explanation of the *M* factor, see 2.9.3.4.6.4.

**2.9.3.4.6.3 Classification for categories Chronic 1 and 2**

**2.9.3.4.6.3.1** First, all ingredients classified as Chronic 1 are considered. If the sum of the concentrations (in %) of these ingredients is greater than or equal to 25% the mixture shall be classified as Chronic 1. If the result of the calculation is a classification of the mixture as Chronic 1 the classification procedure is completed.

**2.9.3.4.6.3.2** In cases where the mixture is not classified as Chronic 1, classification of the mixture as Chronic 2 is considered. A mixture shall be classified as Chronic 2 if 10 times the sum of the concentrations (in %) of all ingredients classified as Chronic 1 plus the sum of the concentrations (in %) of all ingredients classified as Chronic 2 is greater than or equal to 25%. If the result of the calculation is classification of the mixture as Chronic 2, the classification process is completed.

**2.9.3.4.6.3.3** The classification of mixtures for long-term hazards based on this summation of the concentrations of classified ingredients is summarized in table 2.9.4 below.

**Table 2.9.4 – Classification of a mixture for long-term hazards based on summation of the concentrations of classified ingredients**

| Sum of the concentrations (in %) of ingredients classified as:       | Mixture classified as: |
|--|------------------------|
| Chronic 1 $\times M^* \geq 25\%$                                     | Chronic 1              |
| $(M \times 10 \times \text{Chronic 1}) + \text{Chronic 2} \geq 25\%$ | Chronic 2              |

\* For explanation of the *M* factor, see 2.9.3.4.6.4.

**2.9.3.4.6.4 Mixtures with highly toxic ingredients**

**2.9.3.4.6.4.1** Acute 1 or Chronic 1 ingredients with acute toxicities well below 1 mg/L and/or chronic toxicities well below 0.1 mg/L (if non-rapidly degradable) and 0.01 mg/L (if rapidly degradable) may influence the toxicity of the mixture and are given increased weight in applying the summation method. When a mixture contains ingredients classified as Acute 1 or Chronic 1, the tiered approach described in 2.9.3.4.6.2 and 2.9.3.4.6.3 shall be applied using a weighted sum by multiplying the concentrations of Acute 1 and Chronic 1 ingredients by a factor, instead of merely adding up the percentages. This means that the concentration of Acute 1 in the left column of table 2.9.3 and the concentration of Chronic 1 in the left column of table 2.9.4 are multiplied by the appropriate multiplying factor. The multiplying factors to be applied to these ingredients are defined using the toxicity value, as summarized in table 2.9.5 below. Therefore, in order to classify a mixture containing Acute 1 and/or Chronic 1 ingredients, the classifier needs to be informed of the value of the *M* factor in order to apply the summation method. Alternatively, the additivity formula (2.9.3.4.5.2) may be used when toxicity data are available for all highly toxic ingredients in the mixture and there is convincing evidence that all other

## Part 2 – Classification

ingredients, including those for which specific acute and/or chronic toxicity data are not available, are of low or no toxicity and do not significantly contribute to the environmental hazard of the mixture.

Table 2.9.5 – Multiplying factors for highly toxic ingredients of mixtures

| Acute toxicity<br>L(E)C <sub>50</sub> value | M factor | Chronic toxicity<br>NOEC value    | M factor            |                    |
|---|----------|-----------------------------------|---------------------|--------------------|
|   |          |                                   | NRD*<br>ingredients | RD†<br>ingredients |
| 0.1 < L(E)C <sub>50</sub> ≤ 1               | 1        | 0.01 < NOEC ≤ 0.1                 | 1                   | –                  |
| 0.01 < L(E)C <sub>50</sub> ≤ 0.1            | 10       | 0.001 < NOEC ≤ 0.01               | 10                  | 1                  |
| 0.001 < L(E)C <sub>50</sub> ≤ 0.01          | 100      | 0.0001 < NOEC ≤ 0.001             | 100                 | 10                 |
| 0.0001 < L(E)C <sub>50</sub> ≤ 0.001        | 1,000    | 0.00001 < NOEC ≤<br>0.0001        | 1,000               | 100                |
| 0.00001 < L(E)C <sub>50</sub> ≤ 0.0001      | 10,000   | 0.000001 < NOEC ≤<br>0.00001      | 10,000              | 1,000              |
| (continue in factor 10 intervals)           |          | (continue in factor 10 intervals) |                     |                    |

\* Non-rapidly degradable.

† Rapidly degradable.

## 2.9.3.4.6.5 Classification of mixtures with ingredients without any useable information

2.9.3.4.6.5.1 In the event that no useable information on acute and/or chronic aquatic toxicity is available for one or more relevant ingredients, it is concluded that the mixture cannot be attributed (a) definitive hazard category(ies). In this situation the mixture shall be classified based on the known ingredients only.

## 2.9.4 Lithium batteries

Cells and batteries, cells and batteries contained in equipment, or cells and batteries packed with equipment, containing lithium in any form shall be assigned to UN Nos. 3090, 3091, 3480 or 3481 as appropriate. They may be transported under these entries if they meet the following provisions:

- .1 Each cell or battery is of the type proved to meet the requirements of each test of the *Manual of Tests and Criteria*, part III, subsection 38.3.  
Cells and batteries manufactured according to a type meeting the requirements of subsection 38.3 of the *Manual of Tests and Criteria*, revision 3, amendment 1 or any subsequent revision and amendment applicable at the date of the type testing may continue to be transported, unless otherwise provided in this Code.  
Cell and battery types only meeting the requirements of the *Manual of Tests and Criteria*, revision 3, are no longer valid. However, cells and batteries manufactured in conformity with such types before 1 July 2003 may continue to be transported if all other applicable requirements are fulfilled.  
**Note:** Batteries shall be of a type proved to meet the testing requirements of the *Manual of Tests and Criteria*, part III, subsection 38.3, irrespective of whether the cells of which they are composed are of a tested type.
- .2 Each cell and battery incorporates a safety venting device or is designed to preclude a violent rupture under conditions normally incident to transport.
- .3 Each cell and battery is equipped with an effective means of preventing external short circuits.
- .4 Each battery containing cells or series of cells connected in parallel is equipped with effective means as necessary to prevent dangerous reverse current flow (e.g. diodes, fuses, etc.).
- .5 Cells and batteries shall be manufactured under a quality management programme that includes:
  - .1 a description of the organizational structure and responsibilities of personnel with regard to design and product quality;
  - .2 the relevant inspection and test, quality control, quality assurance, and process operation instructions that will be used;
  - .3 process controls that should include relevant activities to prevent and detect internal short circuit failure during manufacture of cells;
  - .4 quality records, such as inspection reports, test data, calibration data and certificates. Test data shall be kept and made available to the competent authority upon request;
  - .5 management reviews to ensure the effective operation of the quality management programme;

- .6 a process for control of documents and their revision;
- .7 a means for control of cells or batteries that are not conforming to the type tested as mentioned in 2.9.4.1 above;
- .8 training programmes and qualification procedures for relevant personnel; and
- .9 procedures to ensure that there is no damage to the final product.

**Note:** In-house quality management programmes may be accepted. Third party certification is not required, but the procedures listed in .1 to .9 above shall be properly recorded and traceable. A copy of the quality management programme shall be made available to the competent authority upon request.

- .6 Lithium batteries, containing both primary lithium metal cells and rechargeable lithium ion cells, that are not designed to be externally charged (see special provision 387 of chapter 3.3) shall meet the following conditions:
  - .1 the rechargeable lithium ion cells can only be charged from the primary lithium metal cells;
  - .2 overcharge of the rechargeable lithium ion cells is precluded by design;
  - .3 the battery has been tested as a lithium primary battery; and
  - .4 component cells of the battery shall be of a type proved to meet the respective testing requirements of the *Manual of Tests and Criteria*, part III, subsection 38.3.
- .7 Except for button cells installed in equipment (including circuit boards), manufacturers and subsequent distributors of cells or batteries manufactured after 30 June 2003 shall make available the test summary as specified in the *Manual of Tests and Criteria*, part III, subsection 38.3, paragraph 38.3.5.
  - **Note:** The term “make available” means that manufacturers and subsequent distributors ensure that the test summary for lithium cells or batteries or equipment with installed lithium cells or batteries is accessible so that the consignor or other persons in the supply chain can confirm compliance.

### ■ 2.9.5 Sodium ion batteries

Cells and batteries, cells and batteries contained in equipment, or cells and batteries packed with equipment containing sodium ion, which are a rechargeable electrochemical system where the positive and negative electrode are both intercalation or insertion compounds, constructed with no metallic sodium (or sodium alloy) in either electrode and with an organic non aqueous compound as electrolyte, shall be assigned to UN Nos. 3551 or 3552, as appropriate.

**Note:** Intercalated sodium exists in an ionic or quasi-atomic form in the lattice of the electrode material.

They may be transported under these entries if they meet the following provisions:

- .1 Each cell or battery is of the type proved to meet the requirements of applicable tests of the *Manual of Tests and Criteria*, part III, subsection 38.3.
- .2 Each cell and battery incorporates a safety venting device or is designed to preclude a violent rupture under conditions normally encountered during transport.
- .3 Each cell and battery is equipped with an effective means of preventing external short circuits.
- .4 Each battery containing cells or a series of cells connected in parallel is equipped with effective means as necessary to prevent dangerous reverse current flow (e.g. diodes, fuses, etc.).
- .5 Cells and batteries shall be manufactured under a quality management program as prescribed under 2.9.4.5.1 to 2.9.4.5.9.
- .6 Manufacturers and subsequent distributors of cells or batteries shall make available the test summary as specified in the *Manual of Tests and Criteria*, Part III, subsection 38.3, paragraph 38.3.5.

## Chapter 2.10

### *Marine pollutants*

#### 2.10.1 Definition

*Marine pollutants* means substances which are subject to the provisions of Annex III of MARPOL, as amended.

#### 2.10.2 General provisions

2.10.2.1 Marine pollutants shall be transported under the provisions of Annex III of MARPOL, as amended.

2.10.2.2 The Index indicates by the symbol **P** in the column headed **MP** those substances, materials and articles that are identified as marine pollutants.

2.10.2.3 Marine pollutants shall be transported under the appropriate entry according to their properties if they fall within the criteria of any of the classes 1 to 8. If they do not fall within the criteria of any of these classes, they shall be transported under the entry: ENVIRONMENTALLY HAZARDOUS SUBSTANCE, SOLID, N.O.S., UN 3077 or ENVIRONMENTALLY HAZARDOUS SUBSTANCE, LIQUID, N.O.S., UN 3082, as appropriate, unless there is a specific entry in class 9.

2.10.2.4 Column 4 of the Dangerous Goods List also provides information on marine pollutants using the symbol **P** for single entries. The absence of the symbol **P** or the presence of a “–” in that column does not preclude the application of 2.10.3.

2.10.2.5 When a substance, material or article possesses properties that meet the criteria of a marine pollutant but is not identified in this Code, such substance, material or article shall be transported as a marine pollutant in accordance with the Code.

2.10.2.6 With the approval of the competent authority (see 7.9.2), substances, materials or articles that are identified as marine pollutants in this Code but which no longer meet the criteria as a marine pollutant need not be transported in accordance with the provisions of this Code applicable to marine pollutants.

△ 2.10.2.7 Marine pollutants also meeting the criteria for inclusion in a hazard class from 1 to 9 (except class 7), and packaged in single or combination packagings containing a net quantity per single or inner packaging of 5 L or less for liquids or having a net mass per single or inner packaging of 5 kg or less for solids, are not subject to the provisions of 5.2.1.6, 5.3.2.3, 5.4.1.4.3.6 and 7.1.4.2 of this Code. These provisions do not apply to substances transported under UN 3077 or UN 3082 (see special provision 375).

#### 2.10.3 Classification

2.10.3.1 Marine pollutants shall be classified in accordance with chapter 2.9.3.

2.10.3.2 The classification criteria of 2.9.3 are not applicable to substances or materials of class 7.

**Part 3 is in Appendix 2**





# **PART 4**

## **PACKING AND TANK PROVISIONS**





## Chapter 4.1

### *Use of packagings, including intermediate bulk containers (IBCs) and large packagings*

#### 4.1.0 Definitions

*Effectively closed:* liquid-tight closure.

*Hermetically sealed:* vapour-tight closure.

*Securely closed:* so closed that dry contents cannot escape during normal handling; the minimum provisions for any closure.

#### 4.1.1 General provisions for the packing of dangerous goods in packagings, including IBCs and large packagings

**Note:** For the packing of goods of classes 2, 6.2 and 7, the general provisions of this section only apply as indicated in 4.1.8.2 (class 6.2, UN 2814 and UN 2900), 4.1.9.1.5 (class 7) and in the applicable packing instructions of 4.1.4 (P201 and LP02 for class 2 and P620, P621, P622, IBC620, LP621 and LP622 for class 6.2).

4.1.1.1 Dangerous goods shall be packed in good quality packagings, including IBCs and large packagings, which shall be strong enough to withstand the shocks and loadings normally encountered during transport, including trans-shipment between cargo transport units and between cargo transport units and warehouses as well as any removal from a pallet or overpack for subsequent manual or mechanical handling. Packagings, including IBCs and large packagings, shall be constructed and closed so as to prevent any loss of contents when prepared for transport which may be caused under normal conditions of transport, by vibration, or by changes in temperature, humidity or pressure (resulting from altitude, for example). Packagings, including IBCs and large packagings, shall be closed in accordance with the information provided by the manufacturer. No dangerous residue shall adhere to the outside of packages, IBCs and large packagings during transport. These provisions apply, as appropriate, to new, reused, reconditioned or remanufactured packagings, and to new, reused, repaired or remanufactured IBCs, and to new, reused or remanufactured large packagings.

4.1.1.2 Parts of packagings, including IBCs and large packagings, which are in direct contact with dangerous goods:

- .1 shall not be affected or significantly weakened by those dangerous goods; and
- .2 shall not cause a dangerous effect, such as catalysing a reaction or reacting with the dangerous goods;
- .3 shall not allow permeation of the dangerous goods that could constitute a danger under normal conditions of transport.

Where necessary, they shall be provided with a suitable inner coating or treatment.

4.1.1.3 Unless otherwise provided elsewhere in this Code, each packaging, including IBCs and large packagings, except inner packagings, shall conform to a design type successfully tested in accordance with the provisions of 6.1.5, 6.3.5, 6.5.6 or 6.6.5, as applicable. However, IBCs manufactured before 1 January 2011 and conforming to a design type which has not passed the vibration test of 6.5.6.13 or which was not required to meet the criteria of 6.5.6.9.5.4 at the time it was subjected to the drop test may still be used.

4.1.1.3.1 Packagings, including IBCs and large packagings, may conform to one or more than one successfully tested design type and may bear more than one mark.

4.1.1.4 When filling packagings, including IBCs and large packagings, with liquids,\* sufficient ullage (outage) shall be left to ensure that neither leakage nor permanent distortion of the packaging occurs as a result of an expansion of the liquid caused by temperatures likely to occur during transport. Unless specific provisions

\* With respect to ullage limits only, the provisions applicable for packagings for solid substances may be used if the viscous substance has an outflow time via a DIN-cup with a 4 mm diameter outlet exceeding 10 minutes at 20°C (corresponding to an outflow time via a Ford cup 4 of more than 690 seconds at 20°C, or to a viscosity of more than 2,680 centistokes at 20°C).

## Part 4 – Packing and tank provisions

are prescribed, liquids shall not completely fill a packaging at a temperature of 55°C. However, sufficient ullage shall be left in an IBC to ensure that at the mean bulk temperature of 50°C it is not filled to more than 98% of its water capacity.\*

- 4.1.1.4.1 For air transport, packagings intended to contain liquids shall also be capable of withstanding a pressure differential without leakage as specified in the international regulations for air transport.
- 4.1.1.5 Inner packagings shall be packed in an outer packaging in such a way that, under normal conditions of transport, they cannot break, be punctured or leak their contents into the outer packaging. Inner packagings containing liquids shall be packaged with their closures upward and placed within outer packagings consistent with the orientation marks prescribed in 5.2.1.7.1 of this Code. Inner packagings that are liable to break or be punctured easily, such as those made of glass, porcelain or stoneware or of certain plastics materials, etc., shall be secured in outer packagings with suitable cushioning material. Any leakage of the contents shall not substantially impair the protective properties of the cushioning material or of the outer packaging.
- 4.1.1.5.1 Where an outer packaging of a combination packaging or a large packaging has been successfully tested with different types of inner packagings, a variety of such different inner packagings may also be assembled in this outer packaging or large packagings. In addition, provided an equivalent level of performance is maintained, the following variations in inner packagings are allowed without further testing of the package:
- .1 Inner packagings of equivalent or smaller size may be used provided:
    - the inner packagings are of similar design to the tested inner packagings (such as shape – round, rectangular, etc.);
    - the material of construction of inner packagings (glass, plastics, metal, etc.) offers resistance to impact and stacking forces equal to or greater than that of the originally tested inner packaging;
    - the inner packagings have the same or smaller openings and the closure is of similar design (such as screw cap, friction lid, etc.);
    - sufficient additional cushioning material is used to take up void spaces and to prevent significant movement of the inner packagings;
    - inner packagings are oriented within the outer packaging in the same manner as in the tested package; and
  - .2 A lesser number of the tested inner packagings or of the alternative types of inner packagings identified in .1 above may be used, provided sufficient cushioning is added to fill the void space(s) and to prevent significant movement of the inner packagings.
- 4.1.1.5.2 Use of supplementary packagings within an outer packaging (e.g. an intermediate packaging or a receptacle inside a required inner packaging) additional to what is required by the packing instructions is authorized provided all relevant requirements are met, including those of 4.1.1.3, and, if appropriate, suitable cushioning is used to prevent movement within the packaging.
- 4.1.1.5.3 Cushioning and absorbent material shall be inert and suited to the nature of the contents.
- 4.1.1.5.4 The nature and the thickness of the outer packagings shall be such that friction during transport does not generate any heating likely to alter dangerously the chemical stability of the contents.
- 4.1.1.6 Dangerous goods shall not be packed together in the same outer packaging, or in large packagings, with dangerous or other goods if they react dangerously with each other and cause:
- .1 combustion and/or evolution of considerable heat;
  - .2 evolution of flammable, toxic or asphyxiant gases;
  - .3 the formation of corrosive substances; or
  - .4 the formation of unstable substances.
- 4.1.1.7 The closures of packagings containing wetted or diluted substances shall be such that the percentage of liquid (water, solvent or phlegmatizer) does not fall below the prescribed limits during transport.
- 4.1.1.7.1 Where two or more closure systems are fitted in series on an IBC, that nearest to the substance being transported shall be closed first.

\* For a differing temperature, the maximum degree of filling may be determined as follows:

$$\text{Degree of filling} = \frac{98}{1 + \alpha (50 - t_F)} \text{ per cent of the capacity of the IBC.}$$

In this formula  $\alpha$  represents the mean coefficient of cubic expansion of the liquid substance between 15°C and 50°C; that is to say, for a maximum rise in the temperature of 35°C, “ $\alpha$ ” is calculated according to the formula:

$$\alpha = \frac{d_{15} - d_{50}}{35 \times d_{50}}$$

where  $d_{15}$  and  $d_{50}$  are the relative densities of the liquid at 15°C and 50°C and  $t_F$  is the mean temperature of the liquid at the time of filling.

Chapter 4.1 – Use of packagings, including IBCs and large packagings

4.1.1.7.2 Unless otherwise specified in the Dangerous Goods List, packages containing substances which:

- .1 evolve flammable gases or vapour;
- .2 may become explosive if allowed to dry;
- .3 evolve toxic gases or vapour;
- .4 evolve corrosive gases or vapour; or
- .5 may react dangerously with the atmosphere

should be hermetically sealed.

4.1.1.8 Where pressure may develop in a package by the emission of gas from the contents (as a result of temperature increase or other causes), the packaging or IBC may be fitted with a vent provided that the gas emitted will not cause danger on account of its toxicity, its flammability, the quantity released, etc.

A venting device shall be fitted if dangerous overpressure may develop due to normal decomposition of substances. The vent shall be so designed that, when the packaging or IBC is in the attitude in which it is intended to be transported, leakages of liquid and the penetration of foreign substances are prevented under normal conditions of transport.

4.1.1.8.1 Liquids may only be filled into inner packagings which have an appropriate resistance to internal pressure that may be developed under normal conditions of transport.

4.1.1.9 New, remanufactured or re-used packagings, including IBCs and large packagings, or reconditioned packagings and repaired or routinely maintained IBCs shall be capable of passing the tests prescribed in 6.1.5, 6.3.5, 6.5.6 or 6.6.5, as applicable. Before being filled and handed over for transport, every packaging, including IBCs and large packagings, shall be inspected to ensure that it is free from corrosion, contamination or other damage and every IBC shall be inspected with regard to the proper functioning of any service equipment. Any packaging which shows signs of reduced strength as compared with the approved design type shall no longer be used or shall be so reconditioned that it is able to withstand the design type tests. Any IBC which shows signs of reduced strength as compared with the tested design type shall no longer be used or shall be so repaired or routinely maintained that it is able to withstand the design type tests.

4.1.1.10 Liquids shall be filled only into packagings, including IBCs, which have an appropriate resistance to the internal pressure that may develop under normal conditions of transport. As the vapour pressure of low-boiling-point liquids is usually high, the strength of receptacles for these liquids shall be sufficient to withstand, with an ample factor of safety, the internal pressure likely to be generated. Packagings and IBCs marked with the hydraulic test pressure prescribed in 6.1.3.1(d) and 6.5.2.2.1, respectively, shall be filled only with a liquid having a vapour pressure:

- .1 such that the total gauge pressure in the packaging or IBC (i.e. the vapour pressure of the filling substance plus the partial pressure of air or other inert gases, less 100 kPa) at 55°C, determined on the basis of a maximum degree of filling in accordance with 4.1.1.4 and a filling temperature of 15°C, will not exceed two thirds of the marked test pressure; or
- .2 at 50°C, less than four sevenths of the sum of the marked test pressure plus 100 kPa; or
- .3 at 55°C, less than two thirds of the sum of the marked test pressure plus 100 kPa.

IBCs intended for the transport of liquids shall not be used to carry liquids having a vapour pressure of more than 110 kPa (1.1 bar) at 50°C or 130 kPa (1.3 bar) at 55°C.

Examples of required marked test pressures for packagings, including IBCs,  
calculated as in 4.1.1.10.3

| UN No. | Name             | Class | Packing group | $V_{p55}$ (kPa) | $V_{p55} \times 1.5$ (kPa) | $(V_{p55} \times 1.5)$ minus 100 (kPa) | Required minimum test pressure (gauge) under 6.1.5.5.4.3 (kPa) | Minimum test pressure (gauge) to be marked on the packaging (kPa) |
|--------|------------------|-------|---------------|-----------------|----------------------------|--|--|---|
| 2056   | Tetrahydrofuran  | 3     | II            | 70              | 105                        | 5                                      | 100  | 100   |
| 2247   | <i>n</i> -Decane | 3     | III           | 1.4             | 2.1                        | -97.9                                  | 100  | 100   |
| 1593   | Dichloromethane  | 6.1   | III           | 164             | 246                        | 146                                    | 146  | 150   |
| 1155   | Diethyl ether    | 3     | I             | 199             | 299                        | 199                                    | 199  | 250   |

**Note 1:** For pure liquids, the vapour pressure at 55°C ( $V_{p55}$ ) can often be obtained from scientific tables.

**Note 2:** The table refers to the use of 4.1.1.10.3 only, which means that the marked test pressure shall exceed 1.5 times the vapour pressure at 55°C less 100 kPa. When, for example, the test pressure for *n*-decane is determined according to 6.1.5.5.4.1, the minimum marked test pressure may be lower.

**Note 3:** For diethyl ether, the required minimum test pressure under 6.1.5.5.5 is 250 kPa.

## Part 4 – Packing and tank provisions

- 4.1.1.11 Empty packagings, including IBCs and large packagings, that have contained a dangerous substance shall be treated in the same manner as is required by this Code for a filled packaging, unless adequate measures have been taken to nullify any hazard.
- 4.1.1.12 Every packaging as specified in chapter 6.1 intended to contain liquids shall successfully undergo a suitable leakproofness test. This test is part of a quality assurance programme as stipulated in 6.1.1.3 which shows the capability of meeting the appropriate test level indicated in 6.1.5.4.4:
- .1 before it is first used for transport;
  - .2 after remanufacturing or reconditioning of any packaging, before it is re-used for transport.
- For this test, the packaging need not have its closures fitted. The inner receptacle of a composite packaging may be tested without the outer packaging, provided the test results are not affected. This test is not necessary for inner packagings of combination packagings or large packagings.
- 4.1.1.13 Packagings, including IBCs, used for solids which may become liquid at temperatures likely to be encountered during transport shall also be capable of containing the substance in the liquid state.
- 4.1.1.14 Packagings, including IBCs, used for powdery or granular substances shall be sift-proof or shall be provided with a liner.
- 4.1.1.15 For plastics drums and jerricans, rigid plastics IBCs and composite IBCs with plastics inner receptacles, unless otherwise approved by the competent authority, the period of use permitted for the transport of dangerous substances shall be five years from the date of manufacture of the receptacles, except where a shorter period of use is prescribed because of the nature of the substance to be transported.
- Note:** For composite IBCs the period of use refers to the date of manufacture of the inner receptacle.
- 4.1.1.16 Where ice is used as a coolant it shall not affect the integrity of the packaging.
- 4.1.1.17 **Explosives, self-reactive substances and organic peroxides**
- Unless specific provision to the contrary is made in this Code, the packagings, including IBCs and large packagings, used for goods of class 1, self-reactive substances of class 4.1 and organic peroxides of class 5.2 shall comply with the provisions for the medium danger group (packing group II).
- 4.1.1.18 **Use of salvage packagings and large salvage packagings**
- 4.1.1.18.1 Damaged, defective, leaking or non-conforming packages, or dangerous goods that have spilled or leaked may be transported in salvage packagings mentioned in 6.1.5.1.11 and 6.6.5.1.9. This does not prevent the use of a larger size packaging or large packaging of appropriate type and performance level and under the conditions of 4.1.1.18.2 and 4.1.1.18.3.
- 4.1.1.18.2 Appropriate measures shall be taken to prevent excessive movement of the damaged or leaking packages within a salvage packaging. When the salvage packaging contains liquids, sufficient inert absorbent material shall be added to eliminate the presence of free liquid.
- 4.1.1.18.3 Appropriate measures shall be taken to ensure there is no dangerous build-up of pressure.
- 4.1.1.19 **Use of salvage pressure receptacles**
- 4.1.1.19.1 In the case of damaged, defective, leaking or non-conforming pressure receptacles, salvage pressure receptacles according to 6.2.3 may be used.
- Note:** A salvage pressure receptacle may be used as an overpack in accordance with 5.1.2. When used as an overpack, marks shall be in accordance with 5.1.2.1 instead of 5.2.1.3.
- 4.1.1.19.2 Pressure receptacles shall be placed in salvage pressure receptacles of suitable size. More than one pressure receptacle may be placed in the same salvage pressure receptacle only if the contents are known and do not react dangerously with each other (see 4.1.1.6). In this case the total sum of water capacities of the placed pressure receptacles shall not exceed 3,000 L. Measures shall be taken to prevent movement of the pressure receptacles within the salvage pressure receptacle, e.g. by partitioning, securing or cushioning.
- 4.1.1.19.3 A pressure receptacle may only be placed in a salvage pressure receptacle if:
- .1 the salvage pressure receptacle is in accordance with 6.2.3.5 and a copy of the approval certificate is available;
  - .2 parts of the salvage pressure receptacle which are, or are likely to be in direct contact with the dangerous goods will not be affected or weakened by those dangerous goods and will not cause a dangerous effect (e.g. catalysing reaction or reacting with the dangerous goods); and
  - .3 the contents of the contained pressure receptacle(s) is limited in pressure and volume so that if totally discharged into the salvage pressure receptacle, the pressure in the salvage pressure receptacle at 65°C will not exceed the test pressure of the salvage pressure receptacle (for gases, see packing instruction

in P200 (3) 4.1.4.1). The reduction of the useable water capacity of the salvage pressure receptacle, e.g. by any contained equipment and cushioning, shall be taken into account.

- 4.1.1.19.4 The proper shipping name, the UN number preceded by the letters “UN” and label(s) as required for packages in chapter 5.2 applicable to the dangerous goods inside the contained pressure receptacle(s) shall be applied to the salvage pressure receptacle for transport.
- 4.1.1.19.5 Salvage pressure receptacles shall be cleaned, purged and visually inspected internally and externally after each use. They shall be periodically inspected and tested in accordance with 6.2.1.6 at least once every five years.
- 4.1.1.20 During transport, packagings, including IBCs and large packagings, shall be securely fastened to or contained within the cargo transport unit, so that lateral or longitudinal movement or impact is prevented and adequate external support is provided.
- 4.1.1.21 Except as provided in 4.1.1.18 and 4.1.1.19, packagings including large packagings and IBCs shall not be filled or discharged while they remain on board.

## 4.1.2 Additional general provisions for the use of IBCs

- 4.1.2.1 When IBCs are used for the transport of liquids with a flashpoint of 60°C (closed cup) or lower, or of powders liable to dust explosion, measures shall be taken to prevent a dangerous electrostatic discharge.
- 4.1.2.2 Every metal, rigid plastics and composite IBC shall be inspected and tested, as relevant, in accordance with 6.5.4.4 or 6.5.4.5:
- before it is put into service;
  - thereafter at intervals not exceeding two and a half and five years, as appropriate; and
  - after the repair or remanufacture, before it is re-used for transport.

An IBC shall not be filled and offered for transport after the date of expiry of the last periodic test or inspection. However, an IBC filled prior to the date of expiry of the last periodic test or inspection may be transported for a period not to exceed three months beyond the date of expiry of the last periodic test or inspection. In addition, an IBC may be transported after the date of expiry of the last periodic test or inspection:

- .1 after emptying but before cleaning, for purposes of performing the required test or inspection prior to refilling; and
- .2 unless otherwise approved by the competent authority, for a period not to exceed six months beyond the date of expiry of the last periodic test or inspection in order to allow the return of dangerous goods or residues for proper disposal or recycling. Reference to this exemption shall be entered in the transport document.

- 4.1.2.3 IBCs of type 31HZ2 when transporting liquids shall be filled to at least 80% of the volume of the outer casing and shall be transported in closed cargo transport units.
- 4.1.2.4 Except for routine maintenance of metal, rigid plastics, composite and flexible IBCs performed by the owner of the IBC, whose State and name or authorized symbol is durably marked on the IBC, the party performing routine maintenance shall durably mark the IBC near the manufacturer’s UN design type mark to show:
- .1 the State in which the routine maintenance was carried out; and
  - .2 the name or authorized symbol of the party performing the routine maintenance.

## 4.1.3 General provisions concerning packing instructions

- 4.1.3.1 Packing instructions applicable to dangerous goods of classes 1 to 9 are specified in 4.1.4. They are subdivided in three subsections depending on the type of packagings to which they apply:
- |                    |   |
|--------------------|---|
| subsection 4.1.4.1 | for packagings other than IBCs and large packagings; these packing instructions are designated by an alphanumeric code comprising the letter “P”; |
| subsection 4.1.4.2 | for IBCs; these are designated by an alphanumeric code comprising the letters “IBC”;  |
| subsection 4.1.4.3 | for large packagings; these are designated by an alphanumeric code comprising the letters “LP”.   |

**Part 4 – Packing and tank provisions**

Generally, packing instructions specify that the general provisions of 4.1.1, 4.1.2 and/or 4.1.3, as appropriate, are applicable. They may also require compliance with the special provisions of 4.1.5, 4.1.6, 4.1.7, 4.1.8 or 4.1.9 when appropriate. Special packing provisions may also be specified in the packing instruction for individual substances or articles. They are also designated by an alphanumeric code comprising the letters:

- “PP” for packagings other than IBCs and large packagings
- “B” for IBCs
- “L” for large packagings.

Unless otherwise specified, each packaging shall conform to the applicable provisions of part 6. Generally, packing instructions do not provide guidance on compatibility and the user shall not select a packaging without checking that the substance is compatible with the packaging material selected (such as, most fluorides are unsuitable for glass receptacles). Where glass receptacles are permitted in the packing instructions, porcelain, earthenware and stoneware packagings are also allowed.

**4.1.3.2** Column 8 of the Dangerous Goods List shows for each article or substance the packing instruction(s) that shall be used. Column 9 indicates the special packing provisions applicable to specific substances or articles.

**4.1.3.3** Each packing instruction shows, where applicable, the acceptable single and combination packagings. For combination packagings, the acceptable outer packagings, inner packagings and, when applicable, the maximum quantity permitted in each inner or outer packaging are shown. *Maximum net mass* and *maximum capacity* are as defined in 1.2.1. Where packagings which need not meet the requirements of 4.1.1.3 (e.g. crates, pallets, etc.) are authorized in a packing instruction or the special provisions named in the Dangerous Goods List, these packagings are not subject to the mass or volume limits generally applicable to packagings conforming to the requirements of chapter 6.1, unless otherwise indicated in the relevant packing instruction or special provision.

**4.1.3.4** The following packagings shall not be used when the substances being transported are liable to become liquid during transport:

**Packagings**

Drums: 1D and 1G

Boxes: 4C1, 4C2, 4D, 4F, 4G and 4H1

Bags: 5L1, 5L2, 5L3, 5H1, 5H2, 5H3, 5H4, 5M1 and 5M2

Composite: 6HC, 6HD1, 6HD2, 6HG1, 6HG2, 6PC, 6PD1, 6PD2, 6PG1, 6PG2 and 6PH1

**Large packagings**

Flexible plastics: 51H (outer packaging)

**IBCs**

For substances of packing group I:

All types of IBCs

For substances of packing groups II and III:

Wooden: 11C, 11D and 11F

Fibreboard: 11G

Flexible: 13H1, 13H2, 13H3, 13H4, 13H5, 13L1, 13L2, 13L3, 13L4, 13M1 and 13M2

Composite: 11HZ2 and 21HZ2

**4.1.3.5** Where the packing instructions in this chapter authorize the use of a particular type of packaging (such as 4G; 1A2), packagings bearing the same packaging identification code followed by the letters “V”, “U” or “W” marked in accordance with the provisions of part 6 (such as “4GV”, “4GU” or “4GW”; “1A2V”, “1A2U” or “1A2W”) may also be used under the same conditions and limitations applicable to the use of that type of packaging according to the relevant packing instructions. For example, a combination packaging marked with the packaging code “4GV” may be used whenever a combination packaging marked “4G” is authorized, provided the provisions in the relevant packing instruction regarding types of inner packagings and quantity limitations are respected.

**4.1.3.6** **Pressure receptacles for liquids and solids**

**4.1.3.6.1** Unless otherwise indicated in this Code, pressure receptacles conforming to:

- .1 the applicable requirements of chapter 6.2; or



## Chapter 4.1 – Use of packagings, including IBCs and large packagings

.2 the National or International standards on the design, construction, testing, manufacturing and inspection, as applied by the country in which the pressure receptacles are manufactured, provided that the provisions of 4.1.3.6 and 6.2.3.3 are met,

are authorized for the transport of any liquid or solid substance other than explosives, thermally unstable substances, organic peroxides, self-reactive substances, substances where significant pressure may develop by evolution of chemical reaction and radioactive material (unless permitted in 4.1.9).

This subsection is not applicable to the substances mentioned in 4.1.4.1, packing instruction P200, table 3.

4.1.3.6.2 Every design type of pressure receptacle shall be approved by the competent authority of the country of manufacture or as indicated in chapter 6.2.

4.1.3.6.3 Unless otherwise indicated, pressure receptacles having a minimum test pressure of 0.6 MPa shall be used.

4.1.3.6.4 Unless otherwise indicated, pressure receptacles may be provided with an emergency pressure relief device designed to avoid bursting in case of overfill or fire accidents.

Pressure receptacle valves shall be designed and constructed in such a way that they are inherently able to withstand damage without release of the contents or shall be protected from damage which could cause inadvertent release of the contents of the pressure receptacle, by one of the methods as given in 4.1.6.1.8.1 to 4.1.6.1.8.5.

4.1.3.6.5 The level of filling shall not exceed 95% of the capacity of the pressure receptacle at 50°C. Sufficient ullage (outage) shall be left to ensure that the pressure receptacle will not be liquid-full at a temperature of 55°C.

4.1.3.6.6 Unless otherwise indicated, pressure receptacles shall be subjected to a periodic inspection and test every five years. The periodic inspection shall include an external examination, an internal examination or alternative method as approved by the competent authority, a pressure test or equivalent effective non-destructive testing with the agreement of the competent authority, including an inspection of all accessories (e.g. tightness of valves, emergency relief valves or fusible elements). Pressure receptacles shall not be filled after they become due for periodic inspection and test but may be transported after the expiry of the time limit. Pressure receptacle repairs shall meet the requirements of 4.1.6.1.11.

4.1.3.6.7 Prior to filling, the filler shall perform an inspection of the pressure receptacle and ensure that the pressure receptacle is authorized for the substances to be transported and that the provisions of this Code have been met. Shut-off valves shall be closed after filling and remain closed during transport. The consignor shall verify that the closures and equipment are not leaking.

4.1.3.6.8 Refillable pressure receptacles shall not be filled with a substance different from that previously contained unless the necessary operations for change of service have been performed.

4.1.3.6.9 Marking of pressure receptacles for liquids and solids according to 4.1.3.6 (not conforming to the requirements of chapter 6.2) shall be in accordance with the requirements of the competent authority of the country of manufacturing.

4.1.3.7 Packagings, including IBCs and large packagings, not specifically authorized in the applicable packing instruction shall not be used for the transport of a substance or article unless specifically approved by the competent authority and provided:

- .1 the alternative packaging complies with the general provisions of this chapter;
- .2 when the packing instruction indicated in the Dangerous Goods List so specifies, the alternative packaging meets the provisions of part 6;
- .3 the competent authority determines that the alternative packaging provides at least the same level of safety as if the substance were packed in accordance with a method specified in the particular packing instruction indicated in the Dangerous Goods List; and
- .4 a copy of the competent authority approval accompanies each consignment or the transport document includes an indication that alternative packaging was approved by the competent authority.

**Note:** The competent authorities granting such approvals shall take action to amend the Code to include the provisions covered by the approval as appropriate.

4.1.3.8 **Unpackaged articles other than class 1 articles**

4.1.3.8.1 Where large and robust articles cannot be packaged in accordance with the requirements of chapter 6.1 or 6.6 and they have to be transported empty, uncleaned and unpackaged, the competent authority may approve such transport. In doing so, the competent authority shall take into account that:

- .1 Large and robust articles shall be strong enough to withstand the shocks and loadings normally encountered during transport, including trans-shipment between cargo transport units and between cargo transport units and warehouses, as well as any removal from a pallet for subsequent manual or mechanical handling.



#### Part 4 – Packing and tank provisions

---

- .2 All closures and openings shall be sealed so that there can be no loss of contents which might be caused under normal conditions of transport, by vibration, or by changes in temperature, humidity or pressure (resulting from altitude, for example). No dangerous residue shall adhere to the outside of the large and robust articles.
- .3 Parts of large and robust articles, which are in direct contact with dangerous goods:
  - .1 shall not be affected or significantly weakened by those dangerous goods; and
  - .2 shall not cause a dangerous effect, e.g. catalysing a reaction or reacting with the dangerous goods.
- .4 Large and robust articles containing liquids shall be stowed and secured to ensure that neither leakage nor permanent distortion of the article occurs during transport.
- .5 They shall be fixed in cradles or crates or other handling devices in such a way that they will not become loose during normal conditions of transport.

4.1.3.8.2 Unpackaged articles approved by the competent authority in accordance with the provisions of 4.1.3.8.1 shall be subject to the consignment procedures of part 5. In addition the consignor of such articles shall ensure that a copy of any such approval is transported with the large and robust articles.

**Note:** A large and robust article may include flexible fuel containment systems, military equipment, machinery or equipment containing dangerous goods above the limited quantity thresholds.

4.1.3.9 Where, in 4.1.3.6 and in the individual packing instructions, cylinders and other pressure receptacles for gases are authorized for the transport of any liquid or solid substance, use is also authorized of cylinders and pressure receptacles of a kind normally used for gases which conform to the requirements of the competent authority of the country in which the cylinder or pressure receptacle is filled. Valves shall be suitably protected. Pressure receptacles with capacities of 1 L or less shall be packed in outer packagings constructed of suitable material of adequate strength and design in relation to the capacity of the packaging and its intended use and secured or cushioned so as to prevent significant movement within the outer packaging during normal conditions of transport.

#### 4.1.4 List of packing instructions

##### 4.1.4.1 Packing instructions concerning the use of packagings (except IBCs and large packagings)

| P001  |      | PACKING INSTRUCTION (LIQUIDS)   |   |                  |                   | P001 |
|---|------|---|---|------------------|-------------------|------|
| The following packagings are authorized provided the general provisions of 4.1.1 and 4.1.3 are met. |      |   |   |                  |                   |      |
| Combination packagings  |      |   | Maximum capacity/net mass (see 4.1.3.3) |                  |                   |      |
| Inner packagings  |      | Outer packagings  | Packing group I                         | Packing group II | Packing group III |      |
| Glass   | 10 L | <b>Drums</b>  |   |                  |                   |      |
| Plastics  | 30 L | steel (1A1, 1A2)  | 75 kg                                   | 400 kg           | 400 kg            |      |
| Metal   | 40 L | aluminium (1B1, 1B2)  | 75 kg                                   | 400 kg           | 400 kg            |      |
|   |      | other metal (1N1, 1N2)  | 75 kg                                   | 400 kg           | 400 kg            |      |
|   |      | plastics (1H1, 1H2)   | 75 kg                                   | 400 kg           | 400 kg            |      |
|   |      | plywood (1D)  | 75 kg                                   | 400 kg           | 400 kg            |      |
|   |      | fibre (1G)  | 75 kg                                   | 400 kg           | 400 kg            |      |
|   |      | <b>Boxes</b>  |   |                  |                   |      |
|   |      | steel (4A)  | 75 kg                                   | 400 kg           | 400 kg            |      |
|   |      | aluminium (4B)  | 75 kg                                   | 400 kg           | 400 kg            |      |
|   |      | other metal (4N)  | 75 kg                                   | 400 kg           | 400 kg            |      |
|   |      | natural wood (4C1, 4C2)   | 75 kg                                   | 400 kg           | 400 kg            |      |
|   |      | plywood (4D)  | 75 kg                                   | 400 kg           | 400 kg            |      |
|   |      | reconstituted wood (4F)   | 75 kg                                   | 400 kg           | 400 kg            |      |
|   |      | fibreboard (4G)   | 75 kg                                   | 400 kg           | 400 kg            |      |
|   |      | expanded plastics (4H1)   | 40 kg                                   | 60 kg            | 60 kg             |      |
|   |      | solid plastics (4H2)  | 75 kg                                   | 400 kg           | 400 kg            |      |
|   |      | <b>Jerricans</b>  |   |                  |                   |      |
|   |      | steel (3A1, 3A2)  | 60 kg                                   | 120 kg           | 120 kg            |      |
|   |      | aluminium (3B1, 3B2)  | 60 kg                                   | 120 kg           | 120 kg            |      |
|   |      | plastics (3H1, 3H2)   | 30 kg                                   | 120 kg           | 120 kg            |      |
| Single packagings   |      |   |   |                  |                   |      |
| <b>Drums</b>  |      |   |   |                  |                   |      |
|   |      | steel, non-removable head (1A1)   | 250 L                                   | 450 L            | 450 L             |      |
|   |      | steel, removable head (1A2)   | prohibited                              | 250 L            | 250 L             |      |
|   |      | aluminium, non-removable head (1B1)   | 250 L                                   | 450 L            | 450 L             |      |
|   |      | aluminium, removable head (1B2)   | prohibited                              | 250 L            | 250 L             |      |
|   |      | other metal, non-removable head (1N1)   | 250 L                                   | 450 L            | 450 L             |      |
|   |      | other metal, removable head (1N2)   | prohibited                              | 250 L            | 250 L             |      |
|   |      | plastics, non-removable head (1H1)  | 250 L*                                  | 450 L            | 450 L             |      |
|   |      | plastics, removable head (1H2)  | prohibited                              | 250 L            | 250 L             |      |
| <b>Jerricans</b>  |      |   |   |                  |                   |      |
|   |      | steel, non-removable head (3A1)   | 60 L                                    | 60 L             | 60 L              |      |
|   |      | steel, removable head (3A2)   | prohibited                              | 60 L             | 60 L              |      |
|   |      | aluminium, non-removable head (3B1)   | 60 L                                    | 60 L             | 60 L              |      |
|   |      | aluminium, removable head (3B2)   | prohibited                              | 60 L             | 60 L              |      |
|   |      | plastics, non-removable head (3H1)  | 60 L*                                   | 60 L             | 60 L              |      |
|   |      | plastics, removable head (3H2)  | prohibited                              | 60 L             | 60 L              |      |
| <b>Composite packagings</b>   |      |   |   |                  |                   |      |
|   |      | Plastics receptacle in steel, aluminium or plastics drum (6HA1, 6HB1, 6HH1)   | 250 L                                   | 250 L            | 250 L             |      |
|   |      | Plastics receptacle in fibre or plywood drum (6HG1, 6HD1)   | 120 L*                                  | 250 L            | 250 L             |      |
|   |      | Plastics receptacle in steel or aluminium crate or box or plastics receptacle in wood, plywood, fibreboard or solid plastics box (6HA2, 6HB2, 6HC, 6HD2, 6HG2 or 6HH2)  | 60 L*                                   | 60 L             | 60 L              |      |
|   |      | Glass receptacle in steel, aluminium, fibre, plywood, expanded or solid plastics drum (6PA1, 6PB1, 6PG1, 6PD1, 6PH1 or 6PH2) or in a steel, aluminium, wood or fibreboard box or in a wickerwork hamper (6PA2, 6PB2, 6PC, 6PG2 or 6PD2) | 60 L                                    | 60 L             | 60 L              |      |
| <b>Pressure receptacles, provided that the general provisions of 4.1.3.6 are met</b>                |      |   |   |                  |                   |      |

\* Not permitted for class 3, packing group I.

Part 4 – Packing and tank provisions

| P001                               | PACKING INSTRUCTION (LIQUIDS) (continued)   | P001 |
|------------------------------------|---|------|
| <b>Special packing provisions:</b> |   |      |
| PP1                                | For UN Nos. 1133, 1210, 1263 and 1866 and for adhesives, printing inks, printing ink related materials, paints, paint related materials and resin solutions which are assigned to UN 3082, metal or plastics packagings for substances of packing groups II and III in quantities of 5 L or less per packaging are not required to meet the performance tests in chapter 6.1 when transported:  |      |
|                                    | (a) in palletized loads, a pallet box or a unit load device, such as individual packagings placed or stacked and secured by strapping, shrink- or stretch-wrapping or other suitable means to a pallet. For sea transport, the palletized loads, pallet boxes or unit load devices shall be firmly packed and secured in closed cargo transport units. On roll-on/roll-off ships the unit loads may be carried in vehicles other than closed vehicles provided they are securely fenced to the full height of the cargo carried; or |      |
|                                    | (b) as an inner packaging of a combination packaging with a maximum net mass of 40 kg.  |      |
| PP2                                | For UN 3065, wooden barrels with a maximum capacity of 250 L and which do not meet the provisions of chapter 6.1 may be used.   |      |
| PP4                                | For UN 1774, packagings shall meet the packing group II performance level.  |      |
| PP5                                | For UN 1204, packagings shall be so constructed that explosion is not possible by reason of increased internal pressure. Gas cylinders and gas receptacles shall not be used for these substances.  |      |
| PP10                               | For UN 1791, for packing group II, the packaging shall be vented.   |      |
| PP31                               | For UN Nos. 1131, 1553, 1693, 1694, 1699, 1701, 2478, 2604, 2785, 3148, 3183, 3184, 3185, 3186, 3187, 3188, 3398 (PG II and III), 3399 (PG II and III), 3413 and 3414, packagings shall be hermetically sealed.   |      |
| PP33                               | For UN 1308, for packing groups I and II, only combination packagings with a maximum gross mass of 75 kg are allowed.   |      |
| PP81                               | For UN 1790 with more than 60% but not more than 85% hydrogen fluoride and UN 2031 with more than 55% nitric acid, the permitted use of plastics drums and jerricans as single packagings shall be two years from their date of manufacture   |      |
| PP93                               | For UN Nos. 3532 and 3534, packagings shall be designed and constructed to permit the release of gas or vapour to prevent a build-up of pressure that could rupture the packagings in the event of loss of stabilization.   |      |

| P002   | PACKING INSTRUCTION (SOLIDS)                                    | P002                           |                  |                   |
|--|---|--------------------------------|------------------|-------------------|
| The following packagings are authorized provided the general provisions of 4.1.1 and 4.1.3 are met.                                      |   |                                |                  |                   |
| Combination packagings   |   | Maximum net mass (see 4.1.3.3) |                  |                   |
| Inner packagings   | Outer packagings  | Packing group I                | Packing group II | Packing group III |
| Glass 10 kg  | <b>Drums</b>  |                                |                  |                   |
| Plastics <sup>1</sup> 30 kg  | steel (1A1, 1A2)  | 125 kg                         | 400 kg           | 400 kg            |
| Metal 40 kg  | aluminium (1B1, 1B2)  | 125 kg                         | 400 kg           | 400 kg            |
| Paper <sup>1, 2, 3</sup> 50 kg   | other metal (1N1, 1N2)  | 125 kg                         | 400 kg           | 400 kg            |
| Fibre <sup>1, 2, 3</sup> 50 kg   | plastics (1H1, 1H2)   | 125 kg                         | 400 kg           | 400 kg            |
|  | plywood (1D)  | 125 kg                         | 400 kg           | 400 kg            |
|  | fibre (1G)  | 125 kg                         | 400 kg           | 400 kg            |
|  | <b>Boxes</b>  |                                |                  |                   |
|  | steel (4A)  | 125 kg                         | 400 kg           | 400 kg            |
|  | aluminium (4B)  | 125 kg                         | 400 kg           | 400 kg            |
|  | other metal (4N)  | 125 kg                         | 400 kg           | 400 kg            |
|  | natural wood (4C1)  | 125 kg                         | 400 kg           | 400 kg            |
|  | natural wood with sift-proof walls (4C2)                        | 250 kg                         | 400 kg           | 400 kg            |
|  | plywood (4D)  | 125 kg                         | 400 kg           | 400 kg            |
|  | reconstituted wood (4F)   | 125 kg                         | 400 kg           | 400 kg            |
|  | fibreboard (4G)   | 75 kg                          | 400 kg           | 400 kg            |
|  | expanded plastics (4H1)   | 40 kg                          | 60 kg            | 60 kg             |
|  | solid plastics (4H2)  | 125 kg                         | 400 kg           | 400 kg            |
|  | <b>Jerricans</b>  |                                |                  |                   |
|  | steel (3A1, 3A2)  | 75 kg                          | 120 kg           | 120 kg            |
|  | aluminium (3B1, 3B2)  | 75 kg                          | 120 kg           | 120 kg            |
|  | plastics (3H1, 3H2)   | 75 kg                          | 120 kg           | 120 kg            |
| <b>Single packagings</b>   |   |                                |                  |                   |
| <b>Drums</b>   |   |                                |                  |                   |
|  | steel (1A1 or 1A2 <sup>4</sup> )                                | 400 kg                         | 400 kg           | 400 kg            |
|  | aluminium (1B1 or 1B2 <sup>4</sup> )                            | 400 kg                         | 400 kg           | 400 kg            |
|  | metal, other than steel or aluminium (1N1 or 1N2 <sup>4</sup> ) | 400 kg                         | 400 kg           | 400 kg            |
|  | plastics (1H1 or 1H2 <sup>4</sup> )                             | 400 kg                         | 400 kg           | 400 kg            |
|  | fibre (1G <sup>5</sup> )  | 400 kg                         | 400 kg           | 400 kg            |
|  | plywood (1D <sup>5</sup> )                                      | 400 kg                         | 400 kg           | 400 kg            |
| <sup>4</sup> These packagings shall not be used for substances of packing group I that may become liquid during transport (see 4.1.3.4). |   |                                |                  |                   |
| <sup>5</sup> These packagings shall not be used when the substances being transported may become liquid during transport (see 4.1.3.4).  |   |                                |                  |                   |



Chapter 4.1 – Use of packagings, including IBCs and large packagings

| P002   | PACKING INSTRUCTION (SOLIDS) <i>(continued)</i>   |                  |                   | P002 |
|--|---|------------------|-------------------|------|
| The following packagings are authorized provided the general provisions of 4.1.1 and 4.1.3 are met.  |   |                  |                   |      |
|  | Maximum net mass (see 4.1.3.3)  |                  |                   |      |
| Single packagings <i>(continued)</i>   | Packing group I   | Packing group II | Packing group III |      |
| <b>Jerricans</b>   |   |                  |                   |      |
| steel (3A1 or 3A2 <sup>4</sup> )   | 120 kg  | 120 kg           | 120 kg            |      |
| aluminium (3B1 or 3B2 <sup>4</sup> )   | 120 kg  | 120 kg           | 120 kg            |      |
| plastics (3H1 or 3H2 <sup>4</sup> )  | 120 kg  | 120 kg           | 120 kg            |      |
| <b>Boxes</b>   |   |                  |                   |      |
| steel (4A) <sup>5</sup>  | Not allowed   | 400 kg           | 400 kg            |      |
| aluminium (4B) <sup>5</sup>  | Not allowed   | 400 kg           | 400 kg            |      |
| other metal (4N) <sup>5</sup>  | Not allowed   | 400 kg           | 400 kg            |      |
| natural wood (4C1) <sup>5</sup>  | Not allowed   | 400 kg           | 400 kg            |      |
| natural wood with sift-proof walls (4C2) <sup>5</sup>  | Not allowed   | 400 kg           | 400 kg            |      |
| plywood (4D) <sup>5</sup>  | Not allowed   | 400 kg           | 400 kg            |      |
| reconstituted wood (4F) <sup>5</sup>   | Not allowed   | 400 kg           | 400 kg            |      |
| fibreboard (4G) <sup>5</sup>   | Not allowed   | 400 kg           | 400 kg            |      |
| solid plastics (4H2) <sup>5</sup>  | Not allowed   | 400 kg           | 400 kg            |      |
| <b>Bags</b>  |   |                  |                   |      |
| bags (5H3, 5H4, 5L3, 5M2) <sup>5</sup>   | Not allowed   | 50 kg            | 50 kg             |      |
| <b>Composite packagings</b>  |   |                  |                   |      |
| Plastics receptacle in steel, aluminium, plywood, fibre or plastics drum (6HA1, 6HB1, 6HG1 <sup>5</sup> , 6HD1 <sup>5</sup> , or 6HH1)   | 400 kg  | 400 kg           | 400 kg            |      |
| Plastics receptacle in steel or aluminium crate or box, wooden box, plywood box, fibreboard box or solid plastics box (6HA2, 6HB2, 6HC, 6HD2 <sup>5</sup> , 6HG2 <sup>5</sup> or 6HH2)   | 75 kg   | 75 kg            | 75 kg             |      |
| Glass receptacle in steel, aluminium, plywood or fibre drum (6PA1, 6PB1, 6PD1 <sup>5</sup> or 6PG1 <sup>5</sup> ) or in steel, aluminium, wood, or fibreboard box or in wickerwork hamper (6PA2, 6PB2, 6PC, 6PG2 <sup>5</sup> or 6PD2 <sup>5</sup> ) or in expanded or solid plastics packaging (6PH2 or 6PH1 <sup>5</sup> ) | 75 kg   | 75 kg            | 75 kg             |      |
| <sup>4</sup> These packagings shall not be used for substances of packing group I that may become liquid during transport (see 4.1.3.4).   |   |                  |                   |      |
| <sup>5</sup> These packagings shall not be used when the substances being transported may become liquid during transport (see 4.1.3.4).  |   |                  |                   |      |
| <b>Pressure receptacles</b> , provided that the general provisions of 4.1.3.6 are met.   |   |                  |                   |      |
| <b>Special packing provisions:</b>   |   |                  |                   |      |
| △ PP7  | For UN 2000, celluloid may be transported unpacked on pallets, wrapped in plastic film and secured by appropriate means, such as steel bands, as a single commodity in closed cargo transport units. Each pallet shall not exceed 1,000 kg.   |                  |                   |      |
| PP8  | For UN 2002, packagings shall be so constructed that explosion is not possible by reason of increased internal pressure. Gas cylinders and gas receptacles shall not be used for these substances.  |                  |                   |      |
| PP9  | For UN Nos. 3175, 3243 and 3244, packagings shall conform to a design type that has passed a leakproofness test at the packing group II performance level. For UN 3175 the leakproofness test is not required when the liquids are fully absorbed in solid material contained in sealed bags.     |                  |                   |      |
| PP11   | For UN 1309, packing group III, and UN 1362, 5H1, 5L1 and 5M1 bags are allowed if they are overpacked in plastic bags and are wrapped in shrink or stretch wrap on pallets.   |                  |                   |      |
| △ PP12   | For UN Nos. 2213 and 3077, 5H1, 5L1 and 5M1 bags are allowed when transported in closed cargo transport units.  |                  |                   |      |
| PP13   | For articles classified under UN 2870, only combination packagings meeting the packing group I performance level are authorized.  |                  |                   |      |
| PP14   | For UN Nos. 2211, 2698 and 3314, packagings are not required to meet the performance tests in chapter 6.1.  |                  |                   |      |
| PP15   | For UN Nos. 1324 and 2623, packagings shall meet the packing group III performance level.   |                  |                   |      |
| PP20   | For UN 2217, any sift-proof, tearproof receptacle may be used.  |                  |                   |      |
| PP30   | For UN 2471, paper or fibre inner packagings are not permitted.   |                  |                   |      |
| PP31   | For UN Nos. 1362, 1463, 1565, 1575, 1626, 1680, 1689, 1698, 1868, 1889, 1932, 2471, 2545, 2546, 2881, 3048, 3088, 3170, 3174, 3181, 3182, 3189, 3190, 3205, 3206, 3341, 3342, 3448, 3449 and 3450, packagings shall be hermetically sealed.   |                  |                   |      |
| PP34   | For UN 2969 (as whole beans), 5H1, 5L1 and 5M1 bags are permitted.  |                  |                   |      |
| PP37   | For UN Nos. 2590 and 2212, 5M1 bags are permitted. All bags of any type shall be transported in closed cargo transport units or be placed in closed rigid overpacks.  |                  |                   |      |
| PP38   | For UN 1309, bags are permitted only in closed cargo transport units or as unit loads.  |                  |                   |      |
| PP84   | For UN 1057, rigid outer packagings meeting the packing group II performance level shall be used. The packagings shall be designed and constructed and arranged to prevent movement, inadvertent ignition of the devices or inadvertent release of flammable gas or liquid.                       |                  |                   |      |
| PP85   | For UN Nos. 1748, 2208, 2880, 3485, 3486 and 3487, bags are not allowed.  |                  |                   |      |
| PP92   | For UN Nos. 3531 and 3533, packagings shall be designed and constructed to permit the release of gas or vapour to prevent a build-up of pressure that could rupture the packagings in the event of loss of stabilization.   |                  |                   |      |
| PP100  | For UN numbers 1309, 1323, 1333, 1376, 1435, 1449, 1457, 1472, 1476, 1483, 1509, 1516, 1567, 1869, 2210, 2858, 2878, 2968, 3089, 3096 and 3125, flexible, fibreboard or wooden packagings shall be sift-proof and water-resistant or shall be fitted with a sift-proof and water-resistant liner. |                  |                   |      |



Part 4 – Packing and tank provisions

| P003   | PACKING INSTRUCTION | P003 |
|--|---------------------|------|
| <p>Dangerous goods shall be placed in suitable outer packagings. The packagings shall meet the provisions of 4.1.1.1, 4.1.1.2, 4.1.1.4, 4.1.1.8 and 4.1.3 and be so designed that they meet the construction provisions of 6.1.4. Outer packagings constructed of suitable material, and of adequate strength and design in relation to the packaging capacity and its intended use, shall be used. Where this packing instruction is used for the transport of articles or inner packagings of combination packagings, the packaging shall be designed and constructed to prevent inadvertent discharge of articles during normal conditions of transport.</p>  |                     |      |
| <p><b>Special packing provisions:</b></p> <p><b>PP16</b> For UN 2800, batteries shall be protected from short circuit within the packagings.</p> <p><b>PP17</b> For UN 2037, packages shall not exceed 55 kg net mass for fibreboard packagings or 125 kg net mass for other packagings.</p> <p><b>PP18</b> For UN 1845, packagings shall be designed and constructed to permit the release of carbon dioxide gas to prevent a build-up of pressure that could rupture the packagings.</p> <p><b>PP19</b> For UN Nos. 1327, 1364, 1365, 1856 and 3360, transport as bales is authorized.</p> <p><b>PP20</b> For UN Nos. 1363, 1386, 1408 and 2793, any sift-proof, tearproof receptacle may be used.</p> <p><b>PP32</b> UN Nos. 2857 and 3358 and robust articles consigned under UN 3164 may be transported unpackaged, in crates or in appropriate overpacks.</p> <p><b>Note:</b> The packagings authorized may exceed a net mass of 400 kg (see 4.1.3.3).</p> <p>△ <b>PP90</b> For UN Nos. 3506 and 3554, sealed inner liners or bags of strong leakproof and puncture resistant material impervious to mercury or gallium, as appropriate, which will prevent escape of the substance from the package irrespective of the position of the package shall be used.</p> <p><b>PP91</b> For UN 1044, large fire extinguishers may also be transported unpackaged provided that the requirements of 4.1.3.8.1.1 to 4.1.3.8.1.5 are met, the valves are protected by one of the methods in accordance with 4.1.6.1.8.1 to 4.1.6.1.8.4 and other equipment mounted on the fire extinguisher is protected to prevent accidental activation. For the purpose of this special packing provision, “large fire extinguishers” means fire extinguishers as described in subparagraphs .3 to .5 of special provision 225 of chapter 3.3.</p> <p><b>PP96</b> For UN 2037 waste gas cartridges transported in accordance with special provision 327, the packagings shall be adequately ventilated to prevent the creation of dangerous atmospheres and the build-up of pressure.</p> <p><b>PP100</b> For UN Nos. 1408 and 2793 flexible, fibreboard or wooden packagings shall be sift-proof and water-resistant or shall be fitted with a sift-proof and water-resistant liner.</p> |                     |      |

| P004   | PACKING INSTRUCTION | P004 |
|--|---------------------|------|
| <p>This instruction applies to UN Nos. 3473, 3476, 3477, 3478 and 3479.</p>  |                     |      |
| <p>The following packagings are authorized:</p> <p>(1) For fuel cell cartridges, provided that the general provisions of 4.1.1.1, 4.1.1.2, 4.1.1.3, 4.1.1.6 and 4.1.3 are met:<br/>Drums (1A2, 1B2, 1N2, 1H2, 1D, 1G);<br/>Boxes (4A, 4B, 4N, 4C1, 4C2, 4D, 4F, 4G, 4H1, 4H2);<br/>Jerricans (3A2, 3B2, 3H2).<br/>Packagings shall conform to the packing group II performance level.</p> <p>(2) For fuel cell cartridges packed with equipment: strong outer packagings which meet the general provisions of 4.1.1.1, 4.1.1.2, 4.1.1.6 and 4.1.3.<br/>When fuel cell cartridges are packed with equipment, they shall be packed in inner packagings or placed in the outer packaging with cushioning material or divider(s) so that the fuel cell cartridges are protected against damage that may be caused by the movement or placement of the contents within the outer packaging.<br/>The equipment shall be secured against movement within the outer packaging.<br/>For the purpose of this packing instruction, “equipment” means apparatus requiring the fuel cell cartridges with which it is packed for its operation.</p> <p>(3) For fuel cell cartridges contained in equipment: strong outer packagings which meet the general provisions of 4.1.1.1, 4.1.1.2, 4.1.1.6 and 4.1.3.<br/>Large robust equipment (see 4.1.3.8) containing fuel cell cartridges may be transported unpackaged. For fuel cell cartridges contained in equipment, the entire system shall be protected against short circuit and inadvertent operation.</p> <p><b>Note:</b> The packagings authorized in (2) and (3) may exceed a net mass of 400 kg (see 4.1.3.3).</p> |                     |      |



Chapter 4.1 – Use of packagings, including IBCs and large packagings

| P005  | PACKING INSTRUCTION | P005 |
|---|---------------------|------|
| This instruction applies to UN Nos. 3528, 3529 and 3530.  |                     |      |
| <p>If the engine or machinery is constructed and designed so that the means of containment containing the dangerous goods affords adequate protection, an outer packaging is not required.</p> <p>Dangerous goods in engines or machinery shall otherwise be packed in outer packagings constructed of suitable material, and of adequate strength and design in relation to the packaging capacity and its intended use, and meeting the applicable requirements of 4.1.1.1, or they shall be fixed in such a way that they will not become loose during normal conditions of transport, e.g. in cradles or crates or other handling devices.</p> <p><b>Note:</b> The packagings authorized may exceed a net mass of 400 kg (see 4.1.3.3).</p> <p>In addition, the manner in which means of containment are contained within the engine or machinery, shall be such that under normal conditions of transport, damage to the means of containment containing the dangerous goods is prevented; and in the event of damage to the means of containment containing liquid dangerous goods, no leakage of the dangerous goods from the engine or machinery is possible (a leakproof liner may be used to satisfy this requirement).</p> <p>Means of containment containing dangerous goods shall be so installed, secured or cushioned as to prevent their breakage or leakage and so as to control their movement within the engine or machinery during normal conditions of transport. Cushioning material shall not react dangerously with the content of the means of containment. Any leakage of the contents shall not substantially impair the protective properties of the cushioning material.</p> <p><b>Additional requirement:</b></p> <p>Other dangerous goods (e.g. batteries, fire extinguishers, compressed gas accumulators or safety devices) required for the functioning or safe operation of the engine or machinery shall be securely mounted in the engine or machine.</p>  |                     |      |
| P006  | PACKING INSTRUCTION | P006 |
| This instruction applies to UN Nos. 3537, 3538, 3540, 3541, 3546, 3547 and 3548.  |                     |      |
| <p>(1) The following packagings are authorized, provided that the general provisions of 4.1.1 and 4.1.3 are met:<br/>Drums (1A2, 1B2, 1N2, 1H2, 1D, 1G);<br/>Boxes (4A, 4B, 4N, 4C1, 4C2, 4D, 4F, 4G, 4H1, 4H2);<br/>Jerricans (3A2, 3B2, 3H2).<br/>Packagings shall conform to the packing group II performance level.</p> <p>(2) In addition, for robust articles the following packagings are authorized:<br/>Strong outer packagings constructed of suitable material and of adequate strength and design in relation to the packaging capacity and its intended use. The packagings shall meet the provisions of 4.1.1.1, 4.1.1.2, 4.1.1.8 and 4.1.3 in order to achieve a level of protection that is at least equivalent to that provided by chapter 6.1. Articles may be transported unpackaged or on pallets when the dangerous goods are afforded equivalent protection by the article in which they are contained.</p> <p><b>Note:</b> The packagings authorized may exceed a net mass of 400 kg (see 4.1.3.3).</p> <p>(3) Additionally, the following conditions shall be met:</p> <p>(a) Receptacles within articles containing liquids or solids shall be constructed of suitable materials and secured in the article in such a way that, under normal conditions of transport, they cannot break, be punctured or leak their contents into the article itself or the outer packaging;</p> <p>(b) Receptacles containing liquids with closures shall be packed with their closures correctly oriented. The receptacles shall in addition conform to the internal pressure test provisions of 6.1.5.5;</p> <p>(c) Receptacles that are liable to break or be punctured easily, such as those made of glass, porcelain or stoneware or of certain plastics materials shall be properly secured. Any leakage of the contents shall not substantially impair the protective properties of the article or of the outer packaging;</p> <p>(d) Receptacles within articles containing gases shall meet the requirements of section 4.1.6 and chapter 6.2 as appropriate or be capable of providing an equivalent level of protection to packing instructions P200 or P208;</p> <p>(e) Where there is no receptacle within the article, the article shall fully enclose the dangerous substances and prevent their release under normal conditions of transport.</p> <p>(4) Articles shall be packed to prevent movement and inadvertent operation during normal conditions of transport.</p> <p>(5) Articles containing pre-production prototype lithium cells or batteries when these prototypes are transported for testing or production runs of not more than 100 lithium cells or batteries that are of a type that have not met the testing requirements of the <i>Manual of Tests and Criteria</i>, part III, subsection 38.3 shall in addition meet the following:</p> <p>(a) Packagings shall conform to the requirements in paragraph (1) of this packing instruction.</p> <p>(b) Appropriate measures shall be taken to minimize the effects of vibration and shocks and prevent movement of the article within the package that may lead to damage and a dangerous condition during transport. When cushioning material is used to meet this requirement it shall be non-combustible and electrically non-conductive.</p> <p>(c) Non-combustibility of the cushioning material shall be assessed according to a standard recognized in the country where the packaging is designed or manufactured.</p> <p>(d) The article may be transported unpackaged under conditions specified by the competent authority. Additional conditions that may be considered in the approval process include, but are not limited to:</p> <p>(i) the article shall be strong enough to withstand the shocks and loadings normally encountered during transport, including trans-shipment between cargo transport units and between cargo transport units and warehouses as well as any removal from a pallet for subsequent manual or mechanical handling; and</p> <p>(ii) the article shall be fixed in cradles or crates or other handling devices in such a way that it will not become loose during normal conditions of transport.</p> |                     |      |





Part 4 – Packing and tank provisions

| P010  |                  | PACKING INSTRUCTION     |                                | P010   |  |
|---|------------------|-------------------------|--------------------------------|--------|--|
| The following packagings are authorized, provided that the general provisions of 4.1.1 and 4.1.3 are met. |                  |                         |                                |        |  |
| Combination packagings  |                  |                         | Maximum net mass (see 4.1.3.3) |        |  |
| Inner packagings  | Outer packagings |                         |                                |        |  |
| Glass 1 L<br>Steel 40 L   | <b>Drums</b>     |                         |                                |        |  |
|   | steel (1A1, 1A2) |                         | 400 kg                         |        |  |
|   |                  | plastics (1H1, 1H2)     |                                | 400 kg |  |
|   |                  | plywood (1D)            |                                | 400 kg |  |
|   |                  | fibre (1G)              |                                | 400 kg |  |
|   |                  | <b>Boxes</b>            |                                |        |  |
|   |                  | steel (4A)              |                                | 400 kg |  |
|   |                  | natural wood (4C1, 4C2) |                                | 400 kg |  |
|   |                  | plywood (4D)            |                                | 400 kg |  |
|   |                  | reconstituted wood (4F) |                                | 400 kg |  |
|   |                  | fibreboard (4G)         |                                | 400 kg |  |
|   |                  | expanded plastics (4H1) |                                | 60 kg  |  |
|   |                  | solid plastics (4H2)    |                                | 400 kg |  |
| Single packagings   |                  |                         | Maximum capacity (see 4.1.3.3) |        |  |
| <b>Drums</b>  |                  |                         |                                |        |  |
| steel, non-removable head (1A1)   |                  |                         | 450 L                          |        |  |
| <b>Jerricans</b>  |                  |                         |                                |        |  |
| steel, non-removable head (3A1)   |                  |                         | 60 L                           |        |  |
| <b>Composite packagings</b>   |                  |                         |                                |        |  |
| plastics receptacle in steel drums (6HA1)   |                  |                         | 250 L                          |        |  |
| <b>Steel pressure receptacles</b>   |                  |                         |                                |        |  |
| provided that the general provisions of 4.1.3.6 are met.  |                  |                         |                                |        |  |

| P099   |  | PACKING INSTRUCTION |  | P099 |
|--|--|---------------------|--|------|
| Only packagings which are approved for these goods by the competent authority may be used (see 4.1.3.7). A copy of the competent authority approval shall accompany each consignment or the transport document shall include an indication that the packaging was approved by the competent authority. |  |                     |  |      |

| P101  |  | PACKING INSTRUCTION |  | P101 |
|---|--|---------------------|--|------|
| Only packagings which are approved by the competent authority may be used. The distinguishing sign used on vehicles in international road traffic* of the country for which the authority acts shall be marked on the transport documents as follows:<br>“Packaging approved by the competent authority of ...” |  |                     |  |      |

\* Distinguishing sign of the State of registration used on motor vehicles and trailers in international road traffic, e.g. in accordance with the Geneva Convention on Road Traffic of 1949 or the Vienna Convention on Road Traffic of 1968.

| P110(a)  |  | PACKING INSTRUCTION  |  | P110(a) |
|--|--|--|--|---------|
| The following packagings are authorized, provided the general packing provisions of 4.1.1, 4.1.3 and special packing provisions of 4.1.5 are met.  |  |  |  |         |
| Inner packagings   | Intermediate packagings  | Outer packagings   |  |         |
| <b>Bags</b><br>plastics<br>textile, plastic coated or lined<br>rubber<br>textile, rubberized<br>textile  | <b>Bags</b><br>plastics<br>textile, plastic coated or lined<br>rubber<br>textile, rubberized | <b>Drums</b>   |  |         |
|  |  | steel (1A1, 1A2)<br>metal, other than steel or aluminium (1N1, 1N2)<br>plastics (1H1, 1H2) |  |         |
| <b>Receptacles</b><br>wood   | <b>Receptacles</b><br>plastics<br>metal<br>wood  |  |  |         |
| <b>Additional provisions:</b>  |  |  |  |         |
| 1 The intermediate packagings shall be filled with water-saturated material such as an anti-freeze solution or wetted cushioning.  |  |  |  |         |
| 2 Outer packagings shall be filled with water-saturated material such as an anti-freeze solution or wetted cushioning. Outer packagings shall be constructed and sealed to prevent evaporation of the wetting solution, except for UN 0224 when transported dry. |  |  |  |         |



Chapter 4.1 – Use of packagings, including IBCs and large packagings

| P110(b) PACKING INSTRUCTION P110(b)   |   |  |
|---|---|--|
| The following packagings are authorized, provided the general packing provisions of 4.1.1, 4.1.3 and special packing provisions of 4.1.5 are met.   |   |  |
| Inner packagings  | Intermediate packagings   | Outer packagings   |
| <b>Receptacles</b><br>metal<br>wood<br>rubber, conductive<br>plastics, conductive<br><br><b>Bags</b><br>rubber, conductive<br>plastics, conductive  | <b>Dividing partitions</b><br>metal<br>wood<br>plastics<br>fibreboard | <b>Boxes</b><br>natural wood, sift-proof wall (4C2)<br>plywood (4D)<br>reconstituted wood (4F)   |
| <b>Special packing provision:</b><br>PP42 For UN Nos. 0074, 0113, 0114, 0129, 0130, 0135 and 0224, the following conditions shall be met:<br>.1 inner packagings shall not contain more than 50 g of explosive substance (quantity corresponding to dry substance);<br>.2 compartments between dividing partitions shall not contain more than one inner packaging, firmly fitted; and<br>.3 the outer packaging may be partitioned into up to 25 compartments. |   |  |
| P111 PACKING INSTRUCTION P111   |   |  |
| The following packagings are authorized, provided the general packing provisions of 4.1.1, 4.1.3 and special packing provisions of 4.1.5 are met.   |   |  |
| Inner packagings  | Intermediate packagings   | Outer packagings   |
| <b>Bags</b><br>paper, waterproofed<br>plastics<br>textile, rubberized<br><br><b>Sheets</b><br>plastics<br>textile, rubberized<br><br><b>Receptacles</b><br>wood   | <i>Not necessary</i>  | <b>Boxes</b><br>steel (4A)<br>aluminium (4B)<br>other metal (4N)<br>natural wood, ordinary (4C1)<br>natural wood, sift-proof (4C2)<br>plywood (4D)<br>reconstituted wood (4F)<br>fibreboard (4G)<br>plastics, expanded (4H1)<br>plastics, solid (4H2)<br><br><b>Drums</b><br>steel (1A1, 1A2)<br>aluminium (1B1, 1B2)<br>other metal (1N1, 1N2)<br>plywood (1D)<br>fibre (1G)<br>plastics (1H1, 1H2) |
| <b>Special packing provision:</b><br>PP43 For UN 0159, inner packagings are not required when metal (1A1, 1A2, 1B1, 1B2, 1N1 or 1N2) or plastics (1H1 or 1H2) drums are used as outer packagings.   |   |  |





Part 4 – Packing and tank provisions

| P112(a)   | PACKING INSTRUCTION<br>(Solid wetted, 1.1D)  |  |  | P112(a) |
|---|--|--|--|---------|
| The following packagings are authorized, provided the general packing provisions of 4.1.1, 4.1.3 and special packing provisions of 4.1.5 are met.   |  |  |  |         |
| Inner packagings  | Intermediate packagings  | Outer packagings   |  |         |
| <b>Bags</b><br>paper, multiwall, water-resistant<br>plastics<br>textile<br>textile, rubberized<br>woven plastics<br><br><b>Receptacles</b><br>metal<br>plastics<br>wood                                   | <b>Bags</b><br>plastics<br>textile, plastic coated or lined<br><br><b>Receptacles</b><br>metal<br>plastics<br>wood | <b>Boxes</b><br>steel (4A)<br>aluminium (4B)<br>other metal (4N)<br>natural wood, ordinary (4C1)<br>natural wood, sift-proof (4C2)<br>plywood (4D)<br>reconstituted wood (4F)<br>fibreboard (4G)<br>plastics, expanded (4H1)<br>plastics, solid (4H2)<br><br><b>Drums</b><br>steel (1A1, 1A2)<br>aluminium (1B1, 1B2)<br>other metal (1N1, 1N2)<br>plywood (1D)<br>fibre (1G)<br>plastics (1H1, 1H2) |  |         |
| <b>Additional provision:</b><br>Intermediate packagings are not required if leakproof removable head drums are used as the outer packaging.   |  |  |  |         |
| <b>Special packing provisions:</b><br>PP26 For UN Nos. 0004, 0076, 0078, 0154, 0219 and 0394, packagings shall be lead-free.<br>PP45 For UN Nos. 0072 and 0226, intermediate packagings are not required. |  |  |  |         |

| P112(b)   | PACKING INSTRUCTION<br>(Solid dry, other than powder 1.1D)                     |  |  | P112(b) |
|---|--|--|--|---------|
| The following packagings are authorized, provided the general packing provisions of 4.1.1, 4.1.3 and special packing provisions of 4.1.5 are met.   |  |  |  |         |
| Inner packagings  | Intermediate packagings  | Outer packagings   |  |         |
| <b>Bags</b><br>paper, kraft<br>paper, multiwall, water-resistant<br>plastics<br>textile<br>textile, rubberized<br>woven plastics  | <b>Bags (for UN 0150 only)</b><br>plastics<br>textile, plastic coated or lined | <b>Bags</b><br>woven plastics, sift-proof (5H2)<br>woven plastics, water-resistant (5H3)<br>plastics, film (5H4)<br>textile, sift-proof (5L2)<br>textile, water-resistant (5L3)<br>paper, multiwall, water-resistant (5M2)<br><br><b>Boxes</b><br>steel (4A)<br>aluminium (4B)<br>other metal (4N)<br>natural wood, ordinary (4C1)<br>natural wood, sift-proof (4C2)<br>plywood (4D)<br>reconstituted wood (4F)<br>fibreboard (4G)<br>plastics, expanded (4H1)<br>plastics, solid (4H2)<br><br><b>Drums</b><br>steel (1A1, 1A2)<br>aluminium (1B1, 1B2)<br>other metal (1N1, 1N2)<br>plywood (1D)<br>fibre (1G)<br>plastics (1H1, 1H2) |  |         |
| <b>Special packing provisions:</b><br>PP26 For UN Nos. 0004, 0076, 0078, 0154, 0216, 0219 and 0386, packagings shall be lead-free.<br>PP46 For UN 0209, bags, sift-proof (5H2) are recommended for flake or prilled TNT in the dry state and a maximum net mass of 30 kg.<br>PP47 For UN 0222, inner packagings are not required when the outer packaging is a bag. |  |  |  |         |



Chapter 4.1 – Use of packagings, including IBCs and large packagings

| P112(c) PACKING INSTRUCTION (Solid dry powder 1.1D) P112(c)   |  |  |
|---|--|--|
| The following packagings are authorized, provided the general packing provisions of 4.1.1, 4.1.3 and special packing provisions of 4.1.5 are met.   |  |  |
| Inner packagings  | Intermediate packagings  | Outer packagings   |
| <b>Bags</b><br>paper, multiwall, water-resistant<br>plastics<br>woven plastics<br><br><b>Receptacles</b><br>fibreboard<br>metal<br>plastics<br>wood   | <b>Bags</b><br>paper, multiwall, water-resistant<br>with inner lining<br>plastics<br><br><b>Receptacles</b><br>metal<br>plastics<br>wood | <b>Boxes</b><br>steel (4A)<br>aluminium (4B)<br>other metal (4N)<br>natural wood, ordinary (4C1)<br>natural wood, sift-proof (4C2)<br>plywood (4D)<br>reconstituted wood (4F)<br>fibreboard (4G)<br>plastics, solid (4H2)<br><br><b>Drums</b><br>steel (1A1, 1A2)<br>aluminium (1B1, 1B2)<br>other metal (1N1, 1N2)<br>plywood (1D)<br>fibre (1G)<br>plastics (1H1, 1H2) |
| <b>Additional provisions:</b><br>1 Inner packagings are not required if drums are used as the outer packaging.<br>2 The packaging shall be sift-proof.  |  |  |
| <b>Special packing provisions:</b><br>PP26 For UN Nos. 0004, 0076, 0078, 0154, 0216, 0219 and 0386, packagings shall be lead-free.<br>PP46 For UN 0209, bags, sift-proof (5H2) are recommended for flake or prilled TNT in the dry state and a maximum net mass of 30 kg.<br>PP48 For UN 0504, metal packagings shall not be used. Packagings of other material with a small amount of metal, for example metal closures or other metal fittings such as those mentioned in 6.1.4, are not considered metal packagings. |  |  |

| P113 PACKING INSTRUCTION P113   |                         |  |
|---|-------------------------|--|
| The following packagings are authorized, provided the general packing provisions of 4.1.1, 4.1.3 and special packing provisions of 4.1.5 are met.   |                         |  |
| Inner packagings  | Intermediate packagings | Outer packagings   |
| <b>Bags</b><br>paper<br>plastics<br>textile, rubberized<br><br><b>Receptacles</b><br>fibreboard<br>metal<br>plastics<br>wood  | <i>Not necessary</i>    | <b>Boxes</b><br>steel (4A)<br>aluminium (4B)<br>other metal (4N)<br>natural wood, ordinary (4C1)<br>natural wood, sift-proof walls (4C2)<br>plywood (4D)<br>reconstituted wood (4F)<br>fibreboard (4G)<br>plastics, solid (4H2)<br><br><b>Drums</b><br>steel (1A1, 1A2)<br>aluminium (1B1, 1B2)<br>other metal (1N1, 1N2)<br>plywood (1D)<br>fibre (1G)<br>plastics (1H1, 1H2) |
| <b>Additional provision:</b><br>The packaging shall be sift-proof.  |                         |  |
| <b>Special packing provisions:</b><br>PP49 For UN Nos. 0094 and 0305, no more than 50 g of substance shall be packed in an inner packaging.<br>PP50 For UN 0027, inner packagings are not necessary when drums are used as the outer packaging.<br>PP51 For UN 0028, paper kraft or waxed paper sheets may be used as inner packagings. |                         |  |



Part 4 – Packing and tank provisions

| P114(a)  | PACKING INSTRUCTION<br>(Solid wetted)  |   |  | P114(a) |
|--|--|---|--|---------|
| The following packagings are authorized, provided the general packing provisions of 4.1.1, 4.1.3 and special packing provisions of 4.1.5 are met.  |  |   |  |         |
| Inner packagings   | Intermediate packagings  | Outer packagings  |  |         |
| <b>Bags</b><br>plastics<br>textile<br>woven plastics<br><br><b>Receptacles</b><br>metal<br>plastics<br>wood  | <b>Bags</b><br>plastics<br>textile, plastic coated or lined<br><br><b>Receptacles</b><br>metal<br>plastics<br><br><b>Dividing partitions</b><br>wood | <b>Boxes</b><br>steel (4A)<br>metal, other than steel or aluminium (4N)<br>natural wood, ordinary (4C1)<br>natural wood, sift-proof walls (4C2)<br>plywood (4D)<br>reconstituted wood (4F)<br>fibreboard (4G)<br>plastics, solid (4H2)<br><br><b>Drums</b><br>steel (1A1, 1A2)<br>aluminium (1B1, 1B2)<br>other metal (1N1, 1N2)<br>plywood (1D)<br>fibre (1G)<br>plastics (1H1, 1H2) |  |         |
| <b>Additional provision:</b><br>Intermediate packagings are not required if leakproof removable head drums are used as the outer packaging.  |  |   |  |         |
| <b>Special packing provisions:</b><br>PP26 For UN Nos. 0077, 0132, 0234, 0235 and 0236, packagings shall be lead-free.<br>PP43 For UN 0342, inner packagings are not required when metal (1A1, 1A2, 1B1, 1B2, 1N1 or 1N2) or plastics (1H1 or 1H2) drums are used as outer packagings. |  |   |  |         |

| P114(b)  | PACKING INSTRUCTION<br>(Solid dry) |   |  | P114(b) |
|--|------------------------------------|---|--|---------|
| The following packagings are authorized, provided the general packing provisions of 4.1.1, 4.1.3 and special packing provisions of 4.1.5 are met.  |                                    |   |  |         |
| Inner packagings   | Intermediate packagings            | Outer packagings  |  |         |
| <b>Bags</b><br>paper, kraft<br>plastics<br>textile, sift-proof<br>woven plastics, sift-proof<br><br><b>Receptacles</b><br>fibreboard<br>metal<br>paper<br>plastics<br>woven plastics, sift-proof<br>wood   | <i>Not necessary</i>               | <b>Boxes</b><br>natural wood, ordinary (4C1)<br>natural wood, sift-proof walls (4C2)<br>plywood (4D)<br>reconstituted wood (4F)<br>fibreboard (4G)<br><br><b>Drums</b><br>steel (1A1, 1A2)<br>aluminium (1B1, 1B2)<br>other metal (1N1, 1N2)<br>plywood (1D)<br>fibre (1G)<br>plastics (1H1, 1H2) |  |         |
| <b>Special packing provisions:</b><br>PP26 For UN Nos. 0077, 0132, 0234, 0235 and 0236, packagings shall be lead-free.<br>PP48 For UN Nos. 0508 and 0509, metal packagings shall not be used. Packagings of other material with a small amount of metal, for example metal closures or other metal fittings such as those mentioned in 6.1.4, are not considered metal packagings.<br>PP50 For UN Nos. 0160, 0161 and 0508, inner packagings are not necessary when drums are used as the outer packaging.<br>PP52 For UN Nos. 0160 and 0161, when metal drums (1A1, 1A2, 1B1, 1B2, 1N1 or 1N2) are used as the outer packaging, metal packagings shall be so constructed that the risk of explosion, by reason of increase in internal pressure from internal or external causes, is prevented. |                                    |   |  |         |



Chapter 4.1 – Use of packagings, including IBCs and large packagings

| P115 PACKING INSTRUCTION P115   |   |  |
|---|---|--|
| The following packagings are authorized, provided the general packing provisions of 4.1.1, 4.1.3 and special packing provisions of 4.1.5 are met.   |   |  |
| Inner packagings  | Intermediate packagings   | Outer packagings   |
| <b>Receptacles</b><br>plastics<br>wood  | <b>Bags</b><br>plastics in metal receptacles<br><br><b>Drums</b><br>metal<br><br><b>Receptacles</b><br>wood | <b>Boxes</b><br>natural wood, ordinary (4C1)<br>natural wood, sift-proof walls (4C2)<br>plywood (4D)<br>reconstituted wood (4F)<br><br><b>Drums</b><br>steel (1A1, 1A2)<br>aluminium (1B1, 1B2)<br>other metal (1N1, 1N2)<br>plywood (1D)<br>fibre (1G)<br>plastics (1H1, 1H2) |
| <p><b>Special packing provisions:</b></p> <p><b>PP45</b> For UN 0144, intermediate packagings are not required.</p> <p><b>PP53</b> For UN Nos. 0075, 0143, 0495 and 0497, when boxes are used as the outer packaging, inner packagings shall have taped screw-cap closures and be not more than 5 L capacity each. Inner packagings shall be surrounded with non-combustible absorbent cushioning materials. The amount of absorbent cushioning material shall be sufficient to absorb the liquid contents. Metal receptacles shall be cushioned from each other. Net mass of propellant is limited to 30 kg for each package when outer packagings are boxes.</p> <p><b>PP54</b> For UN Nos. 0075, 0143, 0495 and 0497, when drums are used as the outer packaging and when intermediate packagings are drums, they shall be surrounded with non-combustible cushioning material in a quantity sufficient to absorb the liquid contents. A composite packaging consisting of a plastics receptacle in a metal drum may be used instead of the inner and intermediate packagings. The net volume of propellant in each package shall not exceed 120 L.</p> <p><b>PP55</b> For UN 0144, absorbent cushioning material shall be inserted.</p> <p><b>PP56</b> For UN 0144, metal receptacles may be used as inner packagings.</p> <p><b>PP57</b> For UN Nos. 0075, 0143, 0495 and 0497, bags shall be used as intermediate packagings when boxes are used as outer packagings.</p> <p><b>PP58</b> For UN Nos. 0075, 0143, 0495 and 0497, drums shall be used as intermediate packagings when drums are used as outer packagings.</p> <p><b>PP59</b> For UN 0144, fibreboard boxes (4G) may be used as outer packagings.</p> <p><b>PP60</b> For UN 0144, aluminium drums (1B1 or 1B2) and metal, other than steel or aluminium, drums (1N1 or 1N2) shall not be used.</p> |   |  |

Part 4 – Packing and tank provisions

| P116 PACKING INSTRUCTION P116  |                         |  |
|--|-------------------------|--|
| The following packagings are authorized, provided the general packing provisions of 4.1.1, 4.1.3 and special packing provisions of 4.1.5 are met.  |                         |  |
| Inner packagings   | Intermediate packagings | Outer packagings   |
| <b>Bags</b><br>paper, water- and oil-resistant<br>plastics<br>textile, plastic coated or lined<br>woven plastics, sift-proof<br><br><b>Receptacles</b><br>fibreboard, water-resistant<br>metal<br>plastics<br>wood, sift-proof<br><br><b>Sheets</b><br>paper, water-resistant<br>paper, waxed<br>plastics  | <i>Not necessary</i>    | <b>Bags</b><br>woven plastics (5H1, 5H2, 5H3)<br>paper, multiwall, water-resistant (5M2)<br>plastics, film (5H4)<br>textile, sift-proof (5L2)<br>textile, water-resistant (5L3)<br><br><b>Boxes</b><br>steel (4A)<br>aluminium (4B)<br>other metal (4N)<br>natural wood, ordinary (4C1)<br>natural wood, sift-proof walls (4C2)<br>plywood (4D)<br>reconstituted wood (4F)<br>fibreboard (4G)<br>plastics, solid (4H2)<br><br><b>Drums</b><br>steel (1A1, 1A2)<br>aluminium (1B1, 1B2)<br>other metal (1N1, 1N2)<br>fibre (1G)<br>plastics (1H1, 1H2)<br>plywood (1D)<br><br><b>Jerricans</b><br>steel (3A1, 3A2)<br>plastics (3H1, 3H2) |
| <b>Special packing provisions:</b><br><b>PP61</b> For UN Nos. 0082, 0241, 0331 and 0332, inner packagings are not required if leakproof removable head drums are used as the outer packaging.<br><b>PP62</b> For UN Nos. 0082, 0241, 0331 and 0332, inner packagings are not required when the explosive is contained in a material impervious to liquid.<br><b>PP63</b> For UN 0081, inner packagings are not required when contained in rigid plastic which is impervious to nitric esters.<br><b>PP64</b> For UN 0331, inner packagings are not required when bags (5H2, 5H3 or 5H4) are used as outer packagings.<br><b>PP65</b> [Deleted]<br><b>PP66</b> For UN 0081, bags shall not be used as outer packagings. |                         |  |



Chapter 4.1 – Use of packagings, including IBCs and large packagings

| P130 PACKING INSTRUCTION P130   |                         |   |
|---|-------------------------|---|
| The following packagings are authorized, provided the general packing provisions of 4.1.1, 4.1.3 and special packing provisions of 4.1.5 are met.   |                         |   |
| Inner packagings  | Intermediate packagings | Outer packagings  |
| <i>Not necessary</i>  | <i>Not necessary</i>    | <b>Boxes</b><br>steel (4A)<br>aluminium (4B)<br>other metal (4N)<br>natural wood, ordinary (4C1)<br>natural wood, sift-proof walls (4C2)<br>plywood (4D)<br>reconstituted wood (4F)<br>fibreboard (4G)<br>plastics, expanded (4H1)<br>plastics, solid (4H2) |
| <b>Drums</b><br>steel (1A1, 1A2)<br>aluminium (1B1, 1B2)<br>other metal (1N1, 1N2)<br>plywood (1D)<br>fibre (1G)<br>plastics (1H1, 1H2)   |                         |   |
| <b>Special packing provision:</b><br><b>PP67</b> The following applies to UN Nos. 0006, 0009, 0010, 0015, 0016, 0018, 0019, 0034, 0035, 0038, 0039, 0048, 0056, 0137, 0138, 0168, 0169, 0171, 0181, 0182, 0183, 0186, 0221, 0243, 0244, 0245, 0246, 0254, 0280, 0281, 0286, 0287, 0297, 0299, 0300, 0301, 0303, 0321, 0328, 0329, 0344, 0345, 0346, 0347, 0362, 0363, 0370, 0412, 0424, 0425, 0434, 0435, 0436, 0437, 0438, 0451, 0488, 0502 and 0510: large and robust explosives articles, normally intended for military use, without their means of initiation or with their means of initiation containing at least two effective protective features, may be transported unpackaged. When such articles have propelling charges or are self-propelled, their ignition systems shall be protected against stimuli encountered during normal conditions of transport. A negative result in Test Series 4 on an unpackaged article indicates that the article can be considered for transport unpackaged. Such unpackaged articles may be fixed to cradles or contained in crates or other suitable handling devices.<br><b>Note:</b> The packagings authorized may exceed a net mass of 400 kg (see 4.1.3.3). |                         |   |

| P131 PACKING INSTRUCTION P131   |                         |   |
|---|-------------------------|---|
| The following packagings are authorized, provided the general packing provisions of 4.1.1, 4.1.3 and special packing provisions of 4.1.5 are met. |                         |   |
| Inner packagings  | Intermediate packagings | Outer packagings  |
| <b>Bags</b><br>paper<br>plastics<br><br><b>Receptacles</b><br>fibreboard<br>metal<br>plastics<br>wood<br><br><b>Reels</b>                         | <i>Not necessary</i>    | <b>Boxes</b><br>steel (4A)<br>aluminium (4B)<br>other metal (4N)<br>natural wood, ordinary (4C1)<br>natural wood, sift-proof walls (4C2)<br>plywood (4D)<br>reconstituted wood (4F)<br>fibreboard (4G)<br>plastics, solid (4H2) |
| <b>Drums</b><br>steel (1A1, 1A2)<br>aluminium (1B1, 1B2)<br>other metal (1N1, 1N2)<br>plywood (1D)<br>fibre (1G)<br>plastics (1H1, 1H2)           |                         |   |
| <b>Special packing provision:</b><br><b>PP68</b> For UN Nos. 0029, 0267 and 0455, bags and reels shall not be used as inner packagings.           |                         |   |



Part 4 – Packing and tank provisions

| P132(a)   | PACKING INSTRUCTION   |   | P132(a) |
|---|---|---|---------|
| (Articles consisting of closed metal, plastics or fibreboard casings that contain a detonating explosive, or consisting of plastics-bonded detonating explosives) |   |   |         |
| The following packagings are authorized, provided the general packing provisions of 4.1.1, 4.1.3 and special packing provisions of 4.1.5 are met.                 |   |   |         |
| Inner packagings  | Intermediate packagings                                       | Outer packagings  |         |
| <i>Not necessary</i>  | <i>Not necessary</i>  | <b>Boxes</b><br>steel (4A)<br>aluminium (4B)<br>other metal (4N)<br>natural wood, ordinary (4C1)<br>natural wood, sift-proof walls (4C2)<br>plywood (4D)<br>reconstituted wood (4F)<br>fibreboard (4G)<br>plastics, solid (4H2) |         |
| P132(b)   | PACKING INSTRUCTION   |   | P132(b) |
| (Articles without closed casings)   |   |   |         |
| The following packagings are authorized, provided the general packing provisions of 4.1.1, 4.1.3 and special packing provisions of 4.1.5 are met.                 |   |   |         |
| Inner packagings  | Intermediate packagings                                       | Outer packagings  |         |
| <b>Receptacles</b><br>fibreboard<br>metal<br>plastics<br>wood<br><br><b>Sheets</b><br>paper<br>plastics   | <i>Not necessary</i>  | <b>Boxes</b><br>steel (4A)<br>aluminium (4B)<br>other metal (4N)<br>natural wood, ordinary (4C1)<br>natural wood, sift-proof walls (4C2)<br>plywood (4D)<br>reconstituted wood (4F)<br>fibreboard (4G)<br>plastics, solid (4H2) |         |
| P133  | PACKING INSTRUCTION   |   | P133    |
| The following packagings are authorized, provided the general packing provisions of 4.1.1, 4.1.3 and special packing provisions of 4.1.5 are met.                 |   |   |         |
| Inner packagings  | Intermediate packagings                                       | Outer packagings  |         |
| <b>Receptacles</b><br>fibreboard<br>metal<br>plastics<br>wood<br><br><b>Trays, fitted with dividing partitions</b><br>fibreboard<br>plastics<br>wood              | <b>Receptacles</b><br>fibreboard<br>metal<br>plastics<br>wood | <b>Boxes</b><br>steel (4A)<br>aluminium (4B)<br>other metal (4N)<br>natural wood, ordinary (4C1)<br>natural wood, sift-proof walls (4C2)<br>plywood (4D)<br>reconstituted wood (4F)<br>fibreboard (4G)<br>plastics, solid (4H2) |         |
| <b>Additional provision:</b><br>Receptacles are only required as intermediate packagings when the inner packagings are trays.                                     |   |   |         |
| <b>Special packing provision:</b><br>PP69 For UN Nos. 0043, 0212, 0225, 0268 and 0306, trays shall not be used as inner packagings.                               |   |   |         |



Chapter 4.1 – Use of packagings, including IBCs and large packagings

| P134 PACKING INSTRUCTION P134  |                         |  |
|--|-------------------------|--|
| The following packagings are authorized, provided the general packing provisions of 4.1.1, 4.1.3 and special packing provisions of 4.1.5 are met.                                    |                         |  |
| Inner packagings   | Intermediate packagings | Outer packagings   |
| <b>Bags</b><br>water-resistant<br><br><b>Receptacles</b><br>fibreboard<br>metal<br>plastics<br>wood<br><br><b>Sheets</b><br>fibreboard, corrugated<br><br><b>Tubes</b><br>fibreboard | <i>Not necessary</i>    | <b>Boxes</b><br>steel (4A)<br>aluminium (4B)<br>other metal (4N)<br>natural wood, ordinary (4C1)<br>natural wood, sift-proof walls (4C2)<br>plywood (4D)<br>reconstituted wood (4F)<br>fibreboard (4G)<br>plastics, expanded (4H1)<br>plastics, solid (4H2)<br><br><b>Drums</b><br>steel (1A1, 1A2)<br>aluminium (1B1, 1B2)<br>other metal (1N1, 1N2)<br>plywood (1D)<br>fibre (1G)<br>plastics (1H1, 1H2) |

| P135 PACKING INSTRUCTION P135   |                         |  |
|---|-------------------------|--|
| The following packagings are authorized, provided the general packing provisions of 4.1.1, 4.1.3 and special packing provisions of 4.1.5 are met. |                         |  |
| Inner packagings  | Intermediate packagings | Outer packagings   |
| <b>Bags</b><br>paper<br>plastics<br><br><b>Receptacles</b><br>fibreboard<br>metal<br>plastics<br>wood<br><br><b>Sheets</b><br>paper<br>plastics   | <i>Not necessary</i>    | <b>Boxes</b><br>steel (4A)<br>aluminium (4B)<br>other metal (4N)<br>natural wood, ordinary (4C1)<br>natural wood, sift-proof walls (4C2)<br>plywood (4D)<br>reconstituted wood (4F)<br>fibreboard (4G)<br>plastics, expanded (4H1)<br>plastics, solid (4H2)<br><br><b>Drums</b><br>steel (1A1, 1A2)<br>aluminium (1B1, 1B2)<br>other metal (1N1, 1N2)<br>plywood (1D)<br>fibre (1G)<br>plastics (1H1, 1H2) |

| P136 PACKING INSTRUCTION P136  |                         |  |
|--|-------------------------|--|
| The following packagings are authorized, provided the general packing provisions of 4.1.1, 4.1.3 and special packing provisions of 4.1.5 are met.  |                         |  |
| Inner packagings   | Intermediate packagings | Outer packagings   |
| <b>Bags</b><br>plastics<br>textile<br><br><b>Boxes</b><br>fibreboard<br>plastics<br>wood<br><br><b>Dividing partitions in the outer packagings</b> | <i>Not necessary</i>    | <b>Boxes</b><br>steel (4A)<br>aluminium (4B)<br>other metal (4N)<br>natural wood, ordinary (4C1)<br>natural wood, sift-proof walls (4C2)<br>plywood (4D)<br>reconstituted wood (4F)<br>fibreboard (4G)<br>plastics, solid (4H2)<br><br><b>Drums</b><br>steel (1A1, 1A2)<br>aluminium (1B1, 1B2)<br>other metal (1N1, 1N2)<br>plywood (1D)<br>fibre (1G)<br>plastics (1H1, 1H2) |





Part 4 – Packing and tank provisions

| P137 PACKING INSTRUCTION P137  |                         |  |
|--|-------------------------|--|
| The following packagings are authorized, provided the general packing provisions of 4.1.1, 4.1.3 and special packing provisions of 4.1.5 are met.  |                         |  |
| Inner packagings   | Intermediate packagings | Outer packagings   |
| <b>Bags</b><br>plastics<br><br><b>Boxes</b><br>fibreboard<br>wood<br><br><b>Tubes</b><br>fibreboard<br>metal<br>plastics<br><br><b>Dividing partitions in the outer packagings</b>   | <i>Not necessary</i>    | <b>Boxes</b><br>steel (4A)<br>aluminium (4B)<br>other metal (4N)<br>natural wood, ordinary (4C1)<br>natural wood, sift-proof walls (4C2)<br>plywood (4D)<br>reconstituted wood (4F)<br>fibreboard (4G)<br>plastics, solid (4H2)<br><br><b>Drums</b><br>steel (1A1, 1A2)<br>aluminium (1B1, 1B2)<br>other metal (1N1, 1N2)<br>plywood (1D)<br>fibre (1G)<br>plastics (1H1, 1H2) |
| <b>Special packing provision:</b><br>PP70 For UN Nos. 0059, 0439, 0440 and 0441, when the shaped charges are packed singly, the conical cavity shall face downwards and the package shall be marked as illustrated in figures in 5.2.1.7.1. When the shaped charges are packed in pairs, the conical cavities shall face inwards to minimize the jetting effect in the event of accidental initiation. |                         |  |

| P138 PACKING INSTRUCTION P138   |                         |  |
|---|-------------------------|--|
| The following packagings are authorized, provided the general packing provisions of 4.1.1, 4.1.3 and special packing provisions of 4.1.5 are met. |                         |  |
| Inner packagings  | Intermediate packagings | Outer packagings   |
| <b>Bags</b><br>plastics   | <i>Not necessary</i>    | <b>Boxes</b><br>steel (4A)<br>aluminium (4B)<br>other metal (4N)<br>natural wood, ordinary (4C1)<br>natural wood, sift-proof walls (4C2)<br>plywood (4D)<br>reconstituted wood (4F)<br>fibreboard (4G)<br>plastics, solid (4H2)<br><br><b>Drums</b><br>steel (1A1, 1A2)<br>aluminium (1B1, 1B2)<br>other metal (1N1, 1N2)<br>plywood (1D)<br>fibre (1G)<br>plastics (1H1, 1H2) |
| <b>Additional provision:</b><br>If the ends of the articles are sealed, inner packagings are not necessary.                                       |                         |  |



Chapter 4.1 – Use of packagings, including IBCs and large packagings

| P139 PACKING INSTRUCTION P139   |                         |  |
|---|-------------------------|--|
| The following packagings are authorized, provided the general packing provisions of 4.1.1, 4.1.3 and special packing provisions of 4.1.5 are met.   |                         |  |
| Inner packagings  | Intermediate packagings | Outer packagings   |
| <b>Bags</b><br>plastics<br><br><b>Receptacles</b><br>fibreboard<br>metal<br>plastics<br>wood<br><br><b>Reels</b><br><br><b>Sheets</b><br>paper<br>plastics  | <i>Not necessary</i>    | <b>Boxes</b><br>steel (4A)<br>aluminium (4B)<br>other metal (4N)<br>natural wood, ordinary (4C1)<br>natural wood, sift-proof walls (4C2)<br>plywood (4D)<br>reconstituted wood (4F)<br>fibreboard (4G)<br>plastics, solid (4H2)<br><br><b>Drums</b><br>steel (1A1, 1A2)<br>aluminium (1B1, 1B2)<br>other metal (1N1, 1N2)<br>plywood (1D)<br>fibre (1G)<br>plastics (1H1, 1H2) |
| <b>Special packing provisions:</b><br><b>PP71</b> For UN Nos. 0065, 0102, 0104, 0289 and 0290, the ends of the detonating cord shall be sealed; for example, by a plug firmly fixed so that the explosive cannot escape. The ends of flexible detonating cord shall be fastened securely.<br><b>PP72</b> For UN Nos. 0065 and 0289, inner packagings are not required when they are in coils. |                         |  |

| P140 PACKING INSTRUCTION P140  |                         |  |
|--|-------------------------|--|
| The following packagings are authorized, provided the general packing provisions of 4.1.1, 4.1.3 and special packing provisions of 4.1.5 are met.  |                         |  |
| Inner packagings   | Intermediate packagings | Outer packagings   |
| <b>Bags</b><br>plastics<br><br><b>Reels</b><br><br><b>Sheets</b><br>paper, kraft<br>plastics<br><br><b>Receptacles</b><br>wood   | <i>Not necessary</i>    | <b>Boxes</b><br>steel (4A)<br>aluminium (4B)<br>other metal (4N)<br>natural wood, ordinary (4C1)<br>natural wood, sift-proof walls (4C2)<br>plywood (4D)<br>reconstituted wood (4F)<br>fibreboard (4G)<br>plastics, solid (4H2)<br><br><b>Drums</b><br>steel (1A1, 1A2)<br>aluminium (1B1, 1B2)<br>other metal (1N1, 1N2)<br>plywood (1D)<br>fibre (1G)<br>plastics (1H1, 1H2) |
| <b>Special packing provisions:</b><br><b>PP73</b> For UN 0105, no inner packagings are required if the ends are sealed.<br><b>PP74</b> For UN 0101, the packaging shall be sift-proof except when the fuse is covered by a paper tube and both ends of the tube are covered with removable caps.<br><b>PP75</b> For UN 0101, steel, aluminium or other metal boxes or drums shall not be used. |                         |  |

Part 4 – Packing and tank provisions

| P141 PACKING INSTRUCTION P141  |                         |  |
|--|-------------------------|--|
| The following packagings are authorized, provided the general packing provisions of 4.1.1, 4.1.3 and special packing provisions of 4.1.5 are met.  |                         |  |
| Inner packagings   | Intermediate packagings | Outer packagings   |
| <b>Receptacles</b><br>fibreboard<br>metal<br>plastics<br>wood<br><br><b>Trays, fitted with dividing partitions</b><br>plastics<br>wood<br><br><b>Dividing partitions in the outer packagings</b> | <i>Not necessary</i>    | <b>Boxes</b><br>steel (4A)<br>aluminium (4B)<br>other metal (4N)<br>natural wood, ordinary (4C1)<br>natural wood, sift-proof walls (4C2)<br>plywood (4D)<br>reconstituted wood (4F)<br>fibreboard (4G)<br>plastics, solid (4H2)<br><br><b>Drums</b><br>steel (1A1, 1A2)<br>aluminium (1B1, 1B2)<br>other metal (1N1, 1N2)<br>plywood (1D)<br>fibre (1G)<br>plastics (1H1, 1H2) |

| P142 PACKING INSTRUCTION P142  |                         |  |
|--|-------------------------|--|
| The following packagings are authorized, provided the general packing provisions of 4.1.1, 4.1.3 and special packing provisions of 4.1.5 are met.  |                         |  |
| Inner packagings   | Intermediate packagings | Outer packagings   |
| <b>Bags</b><br>paper<br>plastics<br><br><b>Receptacles</b><br>fibreboard<br>metal<br>plastics<br>wood<br><br><b>Sheets</b><br>paper<br><br><b>Trays, fitted with dividing partitions</b><br>plastics | <i>Not necessary</i>    | <b>Boxes</b><br>steel (4A)<br>aluminium (4B)<br>other metal (4N)<br>natural wood, ordinary (4C1)<br>natural wood, sift-proof walls (4C2)<br>plywood (4D)<br>reconstituted wood (4F)<br>fibreboard (4G)<br>plastics, solid (4H2)<br><br><b>Drums</b><br>steel (1A1, 1A2)<br>aluminium (1B1, 1B2)<br>other metal (1N1, 1N2)<br>plywood (1D)<br>fibre (1G)<br>plastics (1H1, 1H2) |



Chapter 4.1 – Use of packagings, including IBCs and large packagings

| P143 PACKING INSTRUCTION P143   |                         |  |
|---|-------------------------|--|
| The following packagings are authorized, provided the general packing provisions of 4.1.1, 4.1.3 and special packing provisions of 4.1.5 are met.   |                         |  |
| Inner packagings  | Intermediate packagings | Outer packagings   |
| <b>Bags</b><br>paper, kraft<br>plastics<br>textile<br>textile, rubberized<br><br><b>Receptacles</b><br>fibreboard<br>metal<br>plastics<br>wood<br><br><b>Trays, fitted with dividing partitions</b><br>plastics<br>wood   | <i>Not necessary</i>    | <b>Boxes</b><br>steel (4A)<br>aluminium (4B)<br>other metal (4N)<br>natural wood, ordinary (4C1)<br>natural wood, sift-proof walls (4C2)<br>plywood (4D)<br>reconstituted wood (4F)<br>fibreboard (4G)<br>plastics, solid (4H2)<br><br><b>Drums</b><br>steel (1A1, 1A2)<br>aluminium (1B1, 1B2)<br>other metal (1N1, 1N2)<br>plywood (1D)<br>fibre (1G)<br>plastics (1H1, 1H2) |
| <b>Additional provision:</b><br>Instead of the above inner and outer packagings, composite packagings (6HH2) (plastics receptacle with outer solid box) may be used.  |                         |  |
| <b>Special packing provision:</b><br><b>PP76</b> For UN Nos. 0271, 0272, 0415 and 0491, when metal packagings are used, metal packagings shall be so constructed that the risk of explosion, by reason of increase in internal pressure from internal or external causes, is prevented. |                         |  |

| P144 PACKING INSTRUCTION P144   |                         |  |
|---|-------------------------|--|
| The following packagings are authorized, provided the general packing provisions of 4.1.1, 4.1.3 and special packing provisions of 4.1.5 are met.   |                         |  |
| Inner packagings  | Intermediate packagings | Outer packagings   |
| <b>Receptacles</b><br>fibreboard<br>metal<br>plastics<br>wood<br><br><b>Dividing partitions in the outer packagings</b>   | <i>Not necessary</i>    | <b>Boxes</b><br>steel (4A)<br>aluminium (4B)<br>other metal (4N)<br>natural wood, ordinary with metal liner (4C1)<br>plywood (4D) with metal liner<br>reconstituted wood with metal liner (4F)<br>plastics, expanded (4H1)<br>plastics, solid (4H2)<br><br><b>Drums</b><br>steel (1A1, 1A2)<br>aluminium (1B1, 1B2)<br>other metal (1N1, 1N2)<br>plastics (1H1, 1H2) |
| <b>Special packing provision:</b><br><b>PP77</b> For UN Nos. 0248 and 0249, packagings shall be protected against the ingress of water. When water-activated contrivances are transported unpackaged, they shall be provided with at least two independent protective features which prevent the ingress of water.<br><b>Note:</b> The packagings authorized may exceed a net mass of 400 kg (see 4.1.3.3). |                         |  |



Part 4 – Packing and tank provisions

| P200   | PACKING INSTRUCTION | P200 |
|--|---------------------|------|
| <p>For pressure receptacles, the general packing provisions of 4.1.6.1 shall be met. In addition, for MEGCs, the general requirements of 4.2.4 shall be met.</p> <p>Cylinders, tubes, pressure drums, bundles of cylinders constructed as specified in 6.2 and MEGCs constructed as specified in 6.7.5 are authorized for the transport of a specific substance when specified in the following tables. For some substances, the special packing provisions may prohibit a particular type of cylinder, tube, pressure drum or bundle of cylinders.</p> <p>(1) Pressure receptacles containing toxic substances with an <math>LC_{50}</math> less than or equal to 200 mL/m<sup>3</sup> (ppm) as specified in the table shall not be equipped with any pressure relief device. Pressure relief devices shall be fitted on pressure receptacles used for the transport of UN 1013 carbon dioxide and UN 1070 nitrous oxide. Other pressure receptacles shall be fitted with a pressure relief device if specified by the competent authority of the country of use. The type of pressure relief device, the set-to-discharge pressure and relief capacity of pressure relief devices, if required, shall be specified by the competent authority of the country of use.</p> <p>(2) The following three tables cover compressed gases (Table 1), liquefied and dissolved gases (Table 2) and substances not in Class 2 (Table 3). They provide:</p> <p>(a) The UN number, proper shipping name and classification of the substance;</p> <p>(b) The <math>LC_{50}</math> for toxic substances;</p> <p>(c) The types of pressure receptacles authorized for the substance, shown by the letter "X";</p> <p>(d) The maximum test period for periodic inspection of the pressure receptacles.</p> <p><b>Note:</b> For pressure receptacles which make use of composite materials, the maximum test period shall be 5 years. The test period may be extended to that specified in Tables 1 and 2 (i.e. up to 10 years), if approved by the competent authority of the country of use.</p> <p>(e) The minimum test pressure of the pressure receptacles;</p> <p>(f) The maximum working pressure of the pressure receptacles for compressed gases (where no value is given, the working pressure shall not exceed two thirds of the test pressure) or the maximum filling ratio(s) dependent on the test pressure(s) for liquefied and dissolved gases;</p> <p>(g) Special packing provisions that are specific to a substance.</p> <p>(3) In no case shall pressure receptacles be filled in excess of the limit permitted in the following requirements.</p> <p>(a) For compressed gases, the working pressure shall be not more than two thirds of the test pressure of the pressure receptacles. Restrictions to this upper limit on working pressure are imposed by special packing provision "o" in (5) below. In no case shall the internal pressure at 65°C exceed the test pressure.</p> <p>(b) For high pressure liquefied gases, the filling ratio shall be such that the settled pressure at 65°C does not exceed the test pressure of the pressure receptacles.</p> <p>The use of test pressures and filling ratios other than those in the table is permitted, except where (5), special packing provision "o" applies, provided that:</p> <p>(i) the criterion of (5), special packing provision "r" is met when applicable; or</p> <p>(ii) the above criterion is met in all other cases.</p> <p>For high pressure liquefied gases and gas mixtures for which relevant data are not available, the maximum filling ratio (<i>FR</i>) shall be determined as follows:</p> $FR = 8.5 \times 10^{-4} \times d_g \times P_h$ <p>where <i>FR</i> = maximum filling ratio<br/> <math>d_g</math> = gas density (at 15°C, 1 bar) (in g/L)<br/> <math>P_h</math> = minimum test pressure (in bar)</p> <p>If the density of the gas is unknown, the maximum filling ratio shall be determined as follows:</p> $FR = \frac{P_h \times MM \times 10^{-3}}{R \times 338}$ <p>where <i>FR</i> = maximum filling ratio<br/> <math>P_h</math> = minimum test pressure (in bar)<br/> <math>MM</math> = molecular mass (in g/mol)<br/> <math>R</math> = <math>8.31451 \times 10^{-2}</math> bar-L/mol-K (gas constant)</p> <p>For gas mixtures, the average molecular mass is to be taken, taking into account the volumetric concentrations of the various components.</p> <p>(c) For low pressure liquefied gases, the maximum mass of contents per litre of water capacity shall equal 0.95 times the density of the liquid phase at 50°C; in addition, the liquid phase shall not fill the pressure receptacle at any temperature up to 60°C. The test pressure of the pressure receptacle shall be at least equal to the vapour pressure (absolute) of the liquid at 65°C, minus 100 kPa (1 bar).</p> <p>For low pressure liquefied gases and gas mixtures for which relevant data are not available, the maximum filling ratio shall be determined as follows:</p> $FR = (0.0032 \times BP - 0.24) \times d_l$ <p>where <i>FR</i> = maximum filling ratio<br/> <math>BP</math> = boiling point (in kelvin)<br/> <math>d_l</math> = density of the liquid at boiling point (in kg/L)</p> <p>(d) For UN 1001, acetylene, dissolved, and UN 3374 acetylene, solvent free, see (5), special packing provision "p".</p> |                     |      |



| P200                        | PACKING INSTRUCTION (continued)  | P200           |   |                |   |                |   |                             |  |                |   |  |
|-----------------------------|--|----------------|---|----------------|---|----------------|---|-----------------------------|--|----------------|---|--|
| (e)                         | <p>For liquefied gases charged with compressed gases, both components – the liquefied gas and the compressed gas – have to be taken into consideration in the calculation of the internal pressure in the pressure receptacle.</p> <p>The maximum mass of contents per litre of water capacity shall not exceed 0.95 times the density of the liquid phase at 50°C; in addition, the liquid phase shall not completely fill the pressure receptacle at any temperature up to 60°C.</p> <p>When filled, the internal pressure at 65°C shall not exceed the test pressure of the pressure receptacles. The vapour pressures and volumetric expansions of all substances in the pressure receptacles shall be considered. When experimental data is not available, the following steps shall be carried out:</p> <ol style="list-style-type: none"> <li>(i) calculation of the vapour pressure of the liquefied gas and of the partial pressure of the compressed gas at 15°C (filling temperature);</li> <li>(ii) calculation of the volumetric expansion of the liquid phase resulting from the heating from 15°C to 65°C and calculation of the remaining volume for the gaseous phase;</li> <li>(iii) calculation of the partial pressure of the compressed gas at 65°C considering the volumetric expansion of the liquid phase;</li> </ol> <p><b>Note:</b> The compressibility factor of the compressed gas at 15°C and 65°C shall be considered.</p> <ol style="list-style-type: none"> <li>(iv) calculation of the vapour pressure of the liquefied gas at 65°C;</li> <li>(v) the total pressure is the sum of the vapour pressure of the liquefied gas and the partial pressure of the compressed gas at 65°C;</li> <li>(vi) consideration of the solubility of the compressed gas at 65°C in the liquid phase.</li> </ol> <p>The test pressure of the pressure receptacle shall not be less than the calculated total pressure minus 100 kPa (1bar).</p> <p>If the solubility of the compressed gas in the liquid phase is not known for the calculation, the test pressure can be calculated without taking the gas solubility (subparagraph (vi)) into account.</p>                                     |                |   |                |   |                |   |                             |  |                |   |  |
| (4)                         | <p>The filling of pressure receptacles shall be carried out by qualified staff using appropriate equipment and procedures.</p> <p>The procedures should include checks of:</p> <ol style="list-style-type: none"> <li>(a) the conformity of receptacles and accessories with the provisions of this Code;</li> <li>(b) their compatibility with the product to be transported;</li> <li>(c) the absence of damage which might affect safety;</li> <li>(d) compliance with the degree or pressure of filling, as appropriate;</li> <li>(e) marks and identification.</li> </ol> <p>These requirements are deemed to be met if the following standards are applied:</p> <table border="1" style="width: 100%; border-collapse: collapse;"> <tbody> <tr> <td style="width: 20%;">ISO 10691:2004</td> <td>Gas cylinders – Refillable welded steel cylinders for liquefied petroleum gas (LPG) – Procedures for checking before, during and after filling.</td> </tr> <tr> <td>ISO 11372:2011</td> <td>Gas cylinders – Acetylene cylinders – Filling conditions and filling inspection</td> </tr> <tr> <td>ISO 11755:2005</td> <td>Gas cylinders – Cylinder bundles for compressed and liquefied gases (excluding acetylene) – Inspection at time of filling</td> </tr> <tr> <td>ISO 13088:2011 + Amd 1:2020</td> <td>Gas cylinders – Acetylene cylinder bundles – Filling conditions and filling inspection</td> </tr> <tr> <td>ISO 24431:2016</td> <td>Gas cylinders – Seamless, welded and composite cylinders for compressed and liquefied gases (excluding acetylene) – Inspection at time of filling</td> </tr> </tbody> </table>   | ISO 10691:2004 | Gas cylinders – Refillable welded steel cylinders for liquefied petroleum gas (LPG) – Procedures for checking before, during and after filling. | ISO 11372:2011 | Gas cylinders – Acetylene cylinders – Filling conditions and filling inspection | ISO 11755:2005 | Gas cylinders – Cylinder bundles for compressed and liquefied gases (excluding acetylene) – Inspection at time of filling | ISO 13088:2011 + Amd 1:2020 | Gas cylinders – Acetylene cylinder bundles – Filling conditions and filling inspection | ISO 24431:2016 | Gas cylinders – Seamless, welded and composite cylinders for compressed and liquefied gases (excluding acetylene) – Inspection at time of filling |  |
| ISO 10691:2004              | Gas cylinders – Refillable welded steel cylinders for liquefied petroleum gas (LPG) – Procedures for checking before, during and after filling.  |                |   |                |   |                |   |                             |  |                |   |  |
| ISO 11372:2011              | Gas cylinders – Acetylene cylinders – Filling conditions and filling inspection  |                |   |                |   |                |   |                             |  |                |   |  |
| ISO 11755:2005              | Gas cylinders – Cylinder bundles for compressed and liquefied gases (excluding acetylene) – Inspection at time of filling  |                |   |                |   |                |   |                             |  |                |   |  |
| ISO 13088:2011 + Amd 1:2020 | Gas cylinders – Acetylene cylinder bundles – Filling conditions and filling inspection   |                |   |                |   |                |   |                             |  |                |   |  |
| ISO 24431:2016              | Gas cylinders – Seamless, welded and composite cylinders for compressed and liquefied gases (excluding acetylene) – Inspection at time of filling  |                |   |                |   |                |   |                             |  |                |   |  |
| (5)                         | <p>Special packing provisions:</p> <p><i>Material compatibility</i></p> <ol style="list-style-type: none"> <li>a: Aluminium alloy pressure receptacles shall not be used.</li> <li>b: Copper valves shall not be used.</li> <li>c: Metal parts in contact with the contents shall not contain more than 65% copper.</li> <li>d: When steel pressure receptacles or composite pressure receptacles with steel liners are used, only those bearing the "H" mark in accordance with 6.2.2.7.4 (p) are permitted.</li> </ol> <p><i>Requirements for toxic substances with an LC<sub>50</sub> less than or equal to 200 mL/m<sup>3</sup> (ppm)</i></p> <ol style="list-style-type: none"> <li>k: Valve outlets shall be fitted with pressure-retaining gas-tight plugs or caps having threads that match those of the valve outlets.</li> </ol> <p>Each cylinder within a bundle shall be fitted with an individual valve that shall be closed during transport. After filling, the manifold shall be evacuated, purged and plugged.</p> <p>Bundles containing UN 1045 fluorine, compressed, may be constructed with isolation valves on groups of cylinders not exceeding 150 L total water capacity instead of isolation valves on every cylinder.</p> <p>Cylinders and individual cylinders in a bundle shall have a test pressure greater than or equal to 200 bar and a minimum wall thickness of 3.5 mm for aluminium alloy or 2 mm for steel. Individual cylinders not complying with this requirement shall be transported in a rigid outer packaging that will adequately protect the cylinder and its fittings and meeting the packing group I performance level. Pressure drums shall have a minimum wall thickness as specified by the competent authority.</p> <p>Pressure receptacles shall not be fitted with a pressure relief device.</p> <p>Cylinders and individual cylinders in a bundle shall be limited to a maximum water capacity of 85 L.</p> <p>Each valve shall be capable of withstanding the test pressure of the pressure receptacle and be connected directly to the pressure receptacle by either a taper thread or other means which meets the requirements of ISO 10692-2:2001.</p> |                |   |                |   |                |   |                             |  |                |   |  |

△

## Part 4 – Packing and tank provisions

| P200 | PACKING INSTRUCTION (continued)  | P200 |
|------|--|------|
|      | <p>Each valve shall either be of the packless type with non-perforated diaphragm, or be of a type which prevents leakage through or past the packing.</p> <p>Each pressure receptacle shall be tested for leakage after filling.</p> <p><i>Gas specific provisions</i></p> <p>l: UN 1040 ethylene oxide may also be packed in hermetically sealed glass or metal inner packagings suitably cushioned in fibreboard, wooden or metal boxes meeting the packing group I performance level. The maximum quantity permitted in any glass inner packaging is 30 g, and the maximum quantity permitted in any metal inner packaging is 200 g. After filling, each inner packaging shall be determined to be leaktight by placing the inner packaging in a hot water bath at a temperature, and for a period of time, sufficient to ensure that an internal pressure equal to the vapour pressure of ethylene oxide at 55°C is achieved. The maximum net mass in any outer packaging shall not exceed 2.5 kg.</p> <p>m: Pressure receptacles shall be filled to a working pressure not exceeding 5 bar.</p> <p>n: Cylinders and individual cylinders in a bundle shall contain not more than 5 kg of the gas. When bundles containing UN 1045 fluorine, compressed are divided into groups of cylinders in accordance with special packing provision "k" each group shall contain not more than 5 kg of the gas.</p> <p>o: In no case shall the working pressure or filling ratio shown in the table be exceeded.</p> <p>p: For UN 1001 acetylene, dissolved and UN 3374 acetylene, solvent free: cylinders shall be filled with a homogeneous monolithic porous material; the working pressure and the quantity of acetylene shall not exceed the values prescribed in the approval or in ISO 3807-1:2000, ISO 3807-2:2000 or ISO 3807:2013, as applicable.</p> <p>For UN 1001 acetylene, dissolved: cylinders shall contain a quantity of acetone or suitable solvent as specified in the approval (see ISO 3807-1:2000, ISO 3807-2:2000 or ISO 3807:2013, as applicable); cylinders fitted with pressure relief devices or manifolded together shall be transported vertically. The test pressure of 52 bar applies only to cylinders fitted with a fusible plug.</p> <p>q: Valve outlets of pressure receptacles for pyrophoric gases or flammable mixtures of gases containing more than 1% of pyrophoric compounds shall be fitted with gas-tight plugs or caps. When these pressure receptacles are manifolded in a bundle, each of the pressure receptacles shall be fitted with an individual valve that shall be closed during transport, and the outlet of the manifold valve shall be fitted with a pressure-retaining gas-tight plug or cap. Gas-tight plugs or caps shall have threads that match those of the valve outlets.</p> <p>r: The filling ratio of this gas shall be limited such that, if complete decomposition occurs, the pressure does not exceed two thirds of the test pressure of the pressure receptacle.</p> <p>ra: This gas may also be packed in capsules under the following conditions:</p> <ul style="list-style-type: none"> <li>(i) The mass of gas shall not exceed 150 g per capsule;</li> <li>(ii) The capsules shall be free from faults liable to impair the strength;</li> <li>(iii) The leakproofness of the closure shall be ensured by an additional device (cap, crown, seal, binding, etc.) capable of preventing any leakage of the closure during transport;</li> <li>(iv) The capsules shall be placed in an outer packaging of sufficient strength. A package shall not weigh more than 75 kg.</li> </ul> <p>s: Aluminium alloy pressure receptacles shall be:</p> <ul style="list-style-type: none"> <li>(a) equipped only with brass or stainless steel valves; and</li> <li>(b) cleaned in accordance with ISO 11621:1997 and not contaminated with oil.</li> </ul> <p>t: (a) The wall thickness of pressure receptacles shall be not less than 3 mm.</p> <p>(b) Prior to transport, it shall be ensured that the pressure has not risen due to potential hydrogen generation.</p> <p><i>Periodic inspection</i></p> <p>u: The interval between periodic tests may be extended to 10 years for aluminium alloy pressure receptacles when the alloy of the pressure receptacle has been subjected to stress corrosion testing as specified in ISO 7866:2012 + Cor 1:2014.</p> <p>v: The interval between periodic inspections for steel cylinders may be extended to 15 years if approved by the competent authority of the country of use.</p> <p><i>Requirements for N.O.S. descriptions and for mixtures</i></p> <p>z: The construction materials of the pressure receptacles and their accessories shall be compatible with the contents and shall not react to form harmful or dangerous compounds therewith.</p> <p>The test pressure and filling ratio shall be calculated in accordance with the relevant requirements of (3). Toxic substances with an LC<sub>50</sub> less than or equal to 200 mL/m<sup>3</sup> shall not be transported in tubes, pressure drums or MEGCs and shall meet the requirements of special packing provision "k". However, UN 1975 nitric oxide and dinitrogen tetroxide mixtures may be transported in pressure drums.</p> <p>For pressure receptacles containing pyrophoric gases or flammable mixtures of gases containing more than 1% pyrophoric compounds, the requirements of special packing provision "q" shall be met.</p> <p>The necessary steps shall be taken to prevent dangerous reactions (i.e. polymerization or decomposition) during transport. If necessary, stabilization or addition of an inhibitor shall be required.</p> <p>Mixtures containing UN 1911 diborane shall be filled to a pressure such that, if complete decomposition of the diborane occurs, two thirds of the test pressure of the pressure receptacle shall not be exceeded. Mixtures containing UN 2192 germane, other than mixtures of up to 35% germane in hydrogen or nitrogen or up to 28% germane in helium or argon, shall be filled to a pressure such that, if complete decomposition of the germane occurs, two thirds of the test pressure of the pressure receptacle shall not be exceeded.</p> |      |

Chapter 4.1 – Use of packagings, including IBCs and large packagings

|   |  |
|---|--|
| △ | <p>Mixtures of fluorine and nitrogen with a fluorine concentration below 35% by volume may be filled in pressure receptacles up to a maximum allowable working pressure for which the partial pressure of fluorine does not exceed 31 bar (absolute).</p> $\text{working pressure (bar)} < \frac{31}{x_f} - 1$ <p>in which <math>x_f</math> = fluorine concentration in % by volume/100.</p>   |
| △ | <p>Mixtures of fluorine and inert gases with a fluorine concentration below 35% by volume may be filled in pressure receptacles up to a maximum allowable working pressure for which the partial pressure of fluorine does not exceed 31 bar (absolute), additionally taking the coefficient of nitrogen equivalency in accordance with ISO 10156:2017 into account when calculating the partial pressure.</p> $\text{working pressure (bar)} < \frac{31}{x_f} (x_f + K_k \times x_k) - 1$ <p>in which <math>x_f</math> = fluorine concentration in % by volume/100;<br/> <math>K_k</math> = coefficient of equivalency of an inert gas relative to nitrogen (coefficient of nitrogen equivalency); and<br/> <math>x_k</math> = inert gas concentration in % by volume/100.</p> <p>However, the working pressure for mixtures of fluorine and inert gases shall not exceed 200 bar. The minimum test pressure of pressure receptacles for mixtures of fluorine and inert gases equals 1.5 times the working pressure or 200 bar, with the greater value to be applied.</p> |



Part 4 – Packing and tank provisions

| P200                      |  | PACKING INSTRUCTION (continued) |                    |                                      |           |       |                |                      |       |                    |                     |                                | P200                       |  |
|---------------------------|--|---------------------------------|--------------------|--------------------------------------|-----------|-------|----------------|----------------------|-------|--------------------|---------------------|--------------------------------|----------------------------|--|
| Table 1: COMPRESSED GASES |  |                                 |                    |                                      |           |       |                |                      |       |                    |                     |                                |                            |  |
| UN No.                    | Proper shipping name   | Class                           | Subsidiary hazards | LC <sub>50</sub> , mL/m <sup>3</sup> | Cylinders | Tubes | Pressure drums | Bundles of cylinders | MEGCs | Test period, years | Test pressure, bar* | Maximum working pressure, bar* | Special packing provisions |  |
| 1002                      | AIR, COMPRESSED  | 2.2                             |                    |                                      | X         | X     | X              | X                    | X     | 10                 |                     |                                |                            |  |
| 1006                      | ARGON, COMPRESSED  | 2.2                             |                    |                                      | X         | X     | X              | X                    | X     | 10                 |                     |                                |                            |  |
| 1016                      | CARBON MONOXIDE, COMPRESSED  | 2.3                             | 2.1                | 3,760                                | X         | X     | X              | X                    | X     | 5                  |                     |                                | u                          |  |
| 1023                      | COAL GAS, COMPRESSED   | 2.3                             | 2.1                |                                      | X         | X     | X              | X                    | X     | 5                  |                     |                                |                            |  |
| 1045                      | FLUORINE, COMPRESSED   | 2.3                             | 5.1, 8             | 185                                  | X         |       |                | X                    |       | 5                  | 200                 | 30                             | a, k, n, o                 |  |
| 1046                      | HELIUM, COMPRESSED   | 2.2                             |                    |                                      | X         | X     | X              | X                    | X     | 10                 |                     |                                |                            |  |
| 1049                      | HYDROGEN, COMPRESSED   | 2.1                             |                    |                                      | X         | X     | X              | X                    | X     | 10                 |                     |                                | d                          |  |
| 1056                      | KRYPTON, COMPRESSED  | 2.2                             |                    |                                      | X         | X     | X              | X                    | X     | 10                 |                     |                                |                            |  |
| 1065                      | NEON, COMPRESSED   | 2.2                             |                    |                                      | X         | X     | X              | X                    | X     | 10                 |                     |                                |                            |  |
| 1066                      | NITROGEN, COMPRESSED   | 2.2                             |                    |                                      | X         | X     | X              | X                    | X     | 10                 |                     |                                |                            |  |
| 1071                      | OIL GAS, COMPRESSED  | 2.3                             | 2.1                |                                      | X         | X     | X              | X                    | X     | 5                  |                     |                                |                            |  |
| 1072                      | OXYGEN, COMPRESSED   | 2.2                             | 5.1                |                                      | X         | X     | X              | X                    |       | 10                 |                     |                                | s                          |  |
| 1612                      | HEXAETHYL TETRAPHOSPHATE AND COMPRESSED GAS MIXTURE                      | 2.3                             |                    |                                      | X         | X     | X              | X                    |       | 5                  |                     |                                | z                          |  |
| 1660                      | NITRIC OXIDE, COMPRESSED   | 2.3                             | 5.1, 8             | 115                                  | X         |       |                | X                    |       | 5                  | 225                 | 33                             | k, o                       |  |
| 1953                      | COMPRESSED GAS, TOXIC, FLAMMABLE, N.O.S.                                 | 2.3                             | 2.1                | ≤ 5,000                              | X         | X     | X              | X                    | X     | 5                  |                     |                                | z                          |  |
| 1954                      | COMPRESSED GAS, FLAMMABLE, N.O.S.  | 2.1                             |                    |                                      | X         | X     | X              | X                    | X     | 10                 |                     |                                | z                          |  |
| 1955                      | COMPRESSED GAS, TOXIC, N.O.S.  | 2.3                             |                    | ≤ 5,000                              | X         | X     | X              | X                    | X     | 5                  |                     |                                | z                          |  |
| 1956                      | COMPRESSED GAS, N.O.S.   | 2.2                             |                    |                                      | X         | X     | X              | X                    | X     | 10                 |                     |                                | z                          |  |
| 1957                      | DEUTERIUM, COMPRESSED  | 2.1                             |                    |                                      | X         | X     | X              | X                    | X     | 10                 |                     |                                | d                          |  |
| 1964                      | HYDROCARBON GAS MIXTURE, COMPRESSED, N.O.S.                              | 2.1                             |                    |                                      | X         | X     | X              | X                    | X     | 10                 |                     |                                | z                          |  |
| 1971                      | METHANE, COMPRESSED or NATURAL GAS, COMPRESSED with high methane content | 2.1                             |                    |                                      | X         | X     | X              | X                    | X     | 10                 |                     |                                |                            |  |
| 2034                      | HYDROGEN AND METHANE MIXTURE, COMPRESSED                                 | 2.1                             |                    |                                      | X         | X     | X              | X                    | X     | 10                 |                     |                                | d                          |  |
| 2190                      | OXYGEN DIFLUORIDE, COMPRESSED  | 2.3                             | 5.1, 8             | 2.6                                  | X         |       |                | X                    |       | 5                  | 200                 | 30                             | a, k, n, o                 |  |
| 3156                      | COMPRESSED GAS, OXIDIZING, N.O.S.  | 2.2                             | 5.1                |                                      | X         | X     | X              | X                    | X     | 10                 |                     |                                | z                          |  |
| 3303                      | COMPRESSED GAS, TOXIC, OXIDIZING, N.O.S.                                 | 2.3                             | 5.1                | ≤ 5,000                              | X         | X     | X              | X                    | X     | 5                  |                     |                                | z                          |  |
| 3304                      | COMPRESSED GAS, TOXIC, CORROSIVE, N.O.S.                                 | 2.3                             | 8                  | ≤ 5,000                              | X         | X     | X              | X                    | X     | 5                  |                     |                                | z                          |  |
| 3305                      | COMPRESSED GAS, TOXIC, FLAMMABLE, CORROSIVE, N.O.S.                      | 2.3                             | 2.1, 8             | ≤ 5,000                              | X         | X     | X              | X                    | X     | 5                  |                     |                                | z                          |  |
| 3306                      | COMPRESSED GAS, TOXIC, OXIDIZING, CORROSIVE, N.O.S.                      | 2.3                             | 5.1, 8             | ≤ 5,000                              | X         | X     | X              | X                    | X     | 5                  |                     |                                | z                          |  |

\* Where the entries are blank, the maximum working pressure shall not exceed two thirds of the test pressure.



△

Chapter 4.1 – Use of packagings, including IBCs and large packagings

| P200   |   | PACKING INSTRUCTION (continued) |                    |                                      |           |       |                |                      |       |                    |                          |                              | P200                       |  |
|--|---|---------------------------------|--------------------|--------------------------------------|-----------|-------|----------------|----------------------|-------|--------------------|--------------------------|------------------------------|----------------------------|--|
| Table 2: LIQUEFIED GASES AND DISSOLVED GASES |   |                                 |                    |                                      |           |       |                |                      |       |                    |                          |                              |                            |  |
| UN No.                                       | Proper shipping name  | Class                           | Subsidiary hazards | LC <sub>50</sub> , mL/m <sup>3</sup> | Cylinders | Tubes | Pressure drums | Bundles of cylinders | MEGCs | Test period, years | Test pressure, bar       | Filling ratio                | Special packing provisions |  |
| 1001   | ACETYLENE, DISSOLVED  | 2.1                             |                    |                                      | X         |       |                | X                    |       | 10                 | 60<br>52                 |                              | c, p<br>c, p               |  |
| 1005   | AMMONIA, ANHYDROUS  | 2.3                             | 8                  | 4,000                                | X         | X     | X              | X                    | X     | 5                  | 29                       | 0.54                         | b                          |  |
| 1008   | BORON TRIFLUORIDE   | 2.3                             | 8                  | 864                                  | X         | X     | X              | X                    | X     | 5                  | 225<br>300               | 0.715<br>0.86                | a<br>a                     |  |
| 1009   | BROMOTRIFLUOROMETHANE (REFRIGERANT GAS R 13B1)  | 2.2                             |                    |                                      | X         | X     | X              | X                    | X     | 10                 | 42<br>120<br>250         | 1.13<br>1.44<br>1.60         |                            |  |
| 1010   | BUTADIENES, STABILIZED (1,2-butadiene), or  | 2.1                             |                    |                                      | X         | X     | X              | X                    | X     | 10                 | 10                       | 0.59                         |                            |  |
| 1010   | BUTADIENES, STABILIZED (1,3-butadiene), or  | 2.1                             |                    |                                      | X         | X     | X              | X                    | X     | 10                 | 10                       | 0.55                         |                            |  |
| 1010   | BUTADIENES AND HYDROCARBON MIXTURE, STABILIZED with more than 20% butadienes                    | 2.1                             |                    |                                      | X         | X     | X              | X                    | X     | 10                 |                          |                              | v, z                       |  |
| 1011   | BUTANE  | 2.1                             |                    |                                      | X         | X     | X              | X                    | X     | 10                 | 10                       | 0.52                         | v                          |  |
| 1012   | BUTYLENE (butylenes mixture) or   | 2.1                             |                    |                                      | X         | X     | X              | X                    | X     | 10                 | 10                       | 0.50                         | z                          |  |
| 1012   | BUTYLENE (1-butylene) or  | 2.1                             |                    |                                      | X         | X     | X              | X                    | X     | 10                 | 10                       | 0.53                         |                            |  |
| 1012   | BUTYLENE (cis-2-butylene) or  | 2.1                             |                    |                                      | X         | X     | X              | X                    | X     | 10                 | 10                       | 0.55                         |                            |  |
| 1012   | BUTYLENE (trans-2-butylene)   | 2.1                             |                    |                                      | X         | X     | X              | X                    | X     | 10                 | 10                       | 0.54                         |                            |  |
| 1013   | CARBON DIOXIDE  | 2.2                             |                    |                                      | X         | X     | X              | X                    | X     | 10                 | 190<br>250               | 0.68<br>0.76                 |                            |  |
| 1017   | CHLORINE  | 2.3                             | 5.1, 8             | 293                                  | X         | X     | X              | X                    | X     | 5                  | 22                       | 1.25                         | a                          |  |
| 1018   | CHLORODIFLUOROMETHANE (REFRIGERANT GAS R 22)  | 2.2                             |                    |                                      | X         | X     | X              | X                    | X     | 10                 | 27                       | 1.03                         |                            |  |
| 1020   | CHLOROPENTAFLUOROETHANE (REFRIGERANT GAS R 115)   | 2.2                             |                    |                                      | X         | X     | X              | X                    | X     | 10                 | 25                       | 1.05                         |                            |  |
| 1021   | 1-CHLORO-1,2,2,2-TETRAFLUOROETHANE (REFRIGERANT GAS R 124)                                      | 2.2                             |                    |                                      | X         | X     | X              | X                    | X     | 10                 | 11                       | 1.20                         |                            |  |
| 1022   | CHLOROTRIFLUOROMETHANE (REFRIGERANT GAS R 13)   | 2.2                             |                    |                                      | X         | X     | X              | X                    | X     | 10                 | 100<br>120<br>190<br>250 | 0.83<br>0.90<br>1.04<br>1.11 |                            |  |
| 1026   | CYANOGEN  | 2.3                             | 2.1                | 350                                  | X         | X     | X              | X                    | X     | 5                  | 100                      | 0.70                         | u                          |  |
| 1027   | CYCLOPROPANE  | 2.1                             |                    |                                      | X         | X     | X              | X                    | X     | 10                 | 18                       | 0.55                         |                            |  |
| 1028   | DICHLORODIFLUOROMETHANE (REFRIGERANT GAS R 12)  | 2.2                             |                    |                                      | X         | X     | X              | X                    | X     | 10                 | 16                       | 1.15                         |                            |  |
| 1029   | DICHLOROFLUOROMETHANE (REFRIGERANT GAS R 21)  | 2.2                             |                    |                                      | X         | X     | X              | X                    | X     | 10                 | 10                       | 1.23                         |                            |  |
| 1030   | 1,1-DIFLUOROETHANE (REFRIGERANT GAS R 152a)   | 2.1                             |                    |                                      | X         | X     | X              | X                    | X     | 10                 | 16                       | 0.79                         |                            |  |
| 1032   | DIMETHYLAMINE, ANHYDROUS  | 2.1                             |                    |                                      | X         | X     | X              | X                    | X     | 10                 | 10                       | 0.59                         | b                          |  |
| 1033   | DIMETHYL ETHER  | 2.1                             |                    |                                      | X         | X     | X              | X                    | X     | 10                 | 18                       | 0.58                         |                            |  |
| 1035   | ETHANE  | 2.1                             |                    |                                      | X         | X     | X              | X                    | X     | 10                 | 95<br>120<br>300         | 0.25<br>0.30<br>0.40         |                            |  |
| 1036   | ETHYLAMINE  | 2.1                             |                    |                                      | X         | X     | X              | X                    | X     | 10                 | 10                       | 0.61                         | b                          |  |
| 1037   | ETHYL CHLORIDE  | 2.1                             |                    |                                      | X         | X     | X              | X                    | X     | 10                 | 10                       | 0.80                         | a, ra                      |  |
| 1039   | ETHYL METHYL ETHER  | 2.1                             |                    |                                      | X         | X     | X              | X                    | X     | 10                 | 10                       | 0.64                         |                            |  |
| 1040   | ETHYLENE OXIDE or ETHYLENE OXIDE WITH NITROGEN up to a total pressure of 1 MPa (10 bar) at 50°C | 2.3                             | 2.1                | 2,900                                | X         | X     | X              | X                    | X     | 5                  | 15                       | 0.78                         | l                          |  |

△

△

4

Part 4 – Packing and tank provisions

| P200   |  | PACKING INSTRUCTION (continued) |                    |                                      |           |       |                |                      |       |                    |                          |                              | P200                         |  |
|--|--|---------------------------------|--------------------|--------------------------------------|-----------|-------|----------------|----------------------|-------|--------------------|--------------------------|------------------------------|------------------------------|--|
| Table 2: LIQUEFIED GASES AND DISSOLVED GASES (continued) |  |                                 |                    |                                      |           |       |                |                      |       |                    |                          |                              |                              |  |
| UN No.   | Proper shipping name   | Class                           | Subsidiary hazards | LC <sub>50</sub> , mL/m <sup>3</sup> | Cylinders | Tubes | Pressure drums | Bundles of cylinders | MEGCs | Test period, years | Test pressure, bar       | Filling ratio                | Special packing provisions   |  |
| 1041   | ETHYLENE OXIDE AND CARBON DIOXIDE MIXTURE with more than 9% ethylene oxide but not more than 87% | 2.1                             |                    |                                      | X         | X     | X              | X                    | X     | 10                 | 190<br>250               | 0.66<br>0.75                 |                              |  |
| 1043   | FERTILIZER AMMONIATING SOLUTION with free ammonia  | 2.2                             |                    |                                      | X         |       | X              | X                    |       | 5                  |                          |                              | b, z                         |  |
| 1048   | HYDROGEN BROMIDE, ANHYDROUS  | 2.3                             | 8                  | 2,860                                | X         | X     | X              | X                    | X     | 5                  | 60                       | 1.51                         | a, d                         |  |
| 1050   | HYDROGEN CHLORIDE, ANHYDROUS   | 2.3                             | 8                  | 2,810                                | X         | X     | X              | X                    | X     | 5                  | 100<br>120<br>150<br>200 | 0.30<br>0.56<br>0.67<br>0.74 | a, d<br>a, d<br>a, d<br>a, d |  |
| 1053   | HYDROGEN SULPHIDE  | 2.3                             | 2.1                | 712                                  | X         | X     | X              | X                    | X     | 5                  | 48                       | 0.67                         | d, u                         |  |
| 1055   | ISOBUTYLENE  | 2.1                             |                    |                                      | X         | X     | X              | X                    | X     | 10                 | 10                       | 0.52                         |                              |  |
| 1058   | LIQUEFIED GASES, non-flammable, charged with nitrogen, carbon dioxide or air                     | 2.2                             |                    |                                      | X         | X     | X              | X                    | X     | 10                 |                          |                              | z                            |  |
| 1060   | METHYLACETYLENE AND PROPADIENE MIXTURE, STABILIZED or  | 2.1                             |                    |                                      | X         | X     | X              | X                    | X     | 10                 |                          |                              | c, z                         |  |
| 1060   | METHYLACETYLENE AND PROPADIENE MIXTURE, STABILIZED (Propadiene with 1% to 4% methylacetylene)    | 2.1                             |                    |                                      | X         | X     | X              | X                    | X     | 10                 | 22                       | 0.52                         | c                            |  |
| 1061   | METHYLAMINE, ANHYDROUS   | 2.1                             |                    |                                      | X         | X     | X              | X                    | X     | 10                 | 13                       | 0.58                         | b                            |  |
| 1062   | METHYL BROMIDE with not more than 2% chloropicrin  | 2.3                             |                    | 850                                  | X         | X     | X              | X                    | X     | 5                  | 10                       | 1.51                         | a                            |  |
| 1063   | METHYL CHLORIDE (REFRIGERANT GAS R 40)   | 2.1                             |                    |                                      | X         | X     | X              | X                    | X     | 10                 | 17                       | 0.81                         | a                            |  |
| 1064   | METHYL MERCAPTAN   | 2.3                             | 2.1                | 1,350                                | X         | X     | X              | X                    | X     | 5                  | 10                       | 0.78                         | d, u                         |  |
| 1067   | DINITROGEN TETROXIDE (NITROGEN DIOXIDE)  | 2.3                             | 5.1, 8             | 115                                  | X         |       | X              | X                    |       | 5                  | 10                       | 1.30                         | k                            |  |
| 1069   | NITROSYL CHLORIDE  | 2.3                             | 8                  | 35                                   | X         |       |                | X                    |       | 5                  | 13                       | 1.10                         | k                            |  |
| 1070   | NITROUS OXIDE  | 2.2                             | 5.1                |                                      | X         | X     | X              | X                    | X     | 10                 | 180<br>225<br>250        | 0.68<br>0.74<br>0.75         |                              |  |
| 1075   | PETROLEUM GASES, LIQUEFIED   | 2.1                             |                    |                                      | X         | X     | X              | X                    | X     | 10                 |                          |                              | v, z                         |  |
| 1076   | PHOSGENE   | 2.3                             | 8                  | 5                                    | X         |       | X              | X                    |       | 5                  | 20                       | 1.23                         | k, a                         |  |
| 1077   | PROPYLENE  | 2.1                             |                    |                                      | X         | X     | X              | X                    | X     | 10                 | 27                       | 0.43                         |                              |  |
| 1078   | REFRIGERANT GAS, N.O.S.  | 2.2                             |                    |                                      | X         | X     | X              | X                    | X     | 10                 |                          |                              | z                            |  |
| 1079   | SULPHUR DIOXIDE  | 2.3                             | 8                  | 2,520                                | X         | X     | X              | X                    | X     | 5                  | 12                       | 1.23                         |                              |  |
| 1080   | SULPHUR HEXAFLUORIDE   | 2.2                             |                    |                                      | X         | X     | X              | X                    | X     | 10                 | 70<br>140<br>160         | 1.06<br>1.34<br>1.38         |                              |  |
| 1081   | TETRAFLUOROETHYLENE, STABILIZED  | 2.1                             |                    |                                      | X         | X     | X              | X                    | X     | 10                 | 200                      |                              | m, o                         |  |
| 1082   | TRIFLUOROCHLOROETHYLENE, STABILIZED (REFRIGERANT GAS R 1113)                                     | 2.3                             | 2.1                | 2,000                                | X         | X     | X              | X                    | X     | 5                  | 19                       | 1.13                         | u                            |  |
| 1083   | TRIMETHYLAMINE, ANHYDROUS  | 2.1                             |                    |                                      | X         | X     | X              | X                    | X     | 10                 | 10                       | 0.56                         | b                            |  |
| 1085   | VINYL BROMIDE, STABILIZED  | 2.1                             |                    |                                      | X         | X     | X              | X                    | X     | 10                 | 10                       | 1.37                         | a                            |  |
| 1086   | VINYL CHLORIDE, STABILIZED   | 2.1                             |                    |                                      | X         | X     | X              | X                    | X     | 10                 | 12                       | 0.81                         | a                            |  |
| 1087   | VINYL METHYL ETHER, STABILIZED   | 2.1                             |                    |                                      | X         | X     | X              | X                    | X     | 10                 | 10                       | 0.67                         |                              |  |
| 1581   | CHLOROPICRIN AND METHYL BROMIDE MIXTURE with more than 2% chloropicrin                           | 2.3                             |                    | 850                                  | X         | X     | X              | X                    | X     | 5                  | 10                       | 1.51                         | a                            |  |
| 1582   | CHLOROPICRIN AND METHYL CHLORIDE MIXTURE   | 2.3                             |                    |                                      | X         | X     | X              | X                    | X     | 5                  | 17                       | 0.81                         | a                            |  |
| 1589   | CYANOGEN CHLORIDE, STABILIZED  | 2.3                             | 8                  | 80                                   | X         |       |                | X                    |       | 5                  | 20                       | 1.03                         | k                            |  |
| 1741   | BORON TRICHLORIDE  | 2.3                             | 8                  | 2,541                                | X         | X     | X              | X                    | X     | 5                  | 10                       | 1.19                         | a                            |  |

Chapter 4.1 – Use of packagings, including IBCs and large packagings

| P200   |   | PACKING INSTRUCTION (continued) |                    |                                      |           |       |                |                      |       |                    |                    |               | P200    |                            |
|--|---|---------------------------------|--------------------|--------------------------------------|-----------|-------|----------------|----------------------|-------|--------------------|--------------------|---------------|---------|----------------------------|
| Table 2: LIQUEFIED GASES AND DISSOLVED GASES (continued) |   |                                 |                    |                                      |           |       |                |                      |       |                    |                    |               |         |                            |
| UN No.   | Proper shipping name  | Class                           | Subsidiary hazards | LC <sub>50</sub> , mL/m <sup>3</sup> | Cylinders | Tubes | Pressure drums | Bundles of cylinders | MEGCs | Test period, years | Test pressure, bar | Filling ratio |         | Special packing provisions |
|  |   |                                 |                    |                                      |           |       |                |                      |       |                    |                    |               |         |                            |
| 1749   | CHLORINE TRIFLUORIDE  | 2.3                             | 5.1, 8             | 299                                  | X         | X     | X              | X                    | X     | 5                  | 30                 | 1.40          |         | a                          |
| 1858   | HEXAFLUOROPROPYLENE (REFRIGERANT GAS R 1216)  | 2.2                             |                    |                                      | X         | X     | X              | X                    | X     | 10                 | 22                 | 1.11          |         |                            |
| 1859   | SILICON TETRAFLUORIDE   | 2.3                             | 8                  | 922                                  | X         | X     | X              | X                    | X     | 5                  | 200<br>300         | 0.74<br>1.10  |         | a<br>a                     |
| 1860   | VINYL FLUORIDE, STABILIZED  | 2.1                             |                    |                                      | X         | X     | X              | X                    | X     | 10                 | 250                | 0.64          |         | a                          |
| 1911   | DIBORANE  | 2.3                             | 2.1                | 80                                   | X         |       |                | X                    |       | 5                  | 250                | 0.07          | d, k, o |                            |
| 1912   | METHYL CHLORIDE AND METHYLENE CHLORIDE MIXTURE  | 2.1                             |                    |                                      | X         | X     | X              | X                    | X     | 10                 | 17                 | 0.81          |         | a                          |
| 1952   | ETHYLENE OXIDE AND CARBON DIOXIDE MIXTURE with not more than 9% ethylene oxide  | 2.2                             |                    |                                      | X         | X     | X              | X                    | X     | 10                 | 190<br>250         | 0.66<br>0.75  |         |                            |
| 1958   | 1,2-DICHLORO-1,1,2,2-TETRAFLUOROETHANE (REFRIGERANT GAS R 114)  | 2.2                             |                    |                                      | X         | X     | X              | X                    | X     | 10                 | 10                 | 1.30          |         |                            |
| 1959   | 1,1-DIFLUOROETHYLENE (REFRIGERANT GAS R 1132a)  | 2.1                             |                    |                                      | X         | X     | X              | X                    | X     | 10                 | 250                | 0.77          |         |                            |
| 1962   | ETHYLENE  | 2.1                             |                    |                                      | X         | X     | X              | X                    | X     | 10                 | 225<br>300         | 0.34<br>0.38  |         |                            |
| 1965   | HYDROCARBON GAS MIXTURE, LIQUEFIED, N.O.S.  | 2.1                             |                    |                                      | X         | X     | X              | X                    | X     | 10                 |                    |               |         | v, z                       |
| 1967   | INSECTICIDE GAS, TOXIC, N.O.S.  | 2.3                             |                    |                                      | X         | X     | X              | X                    | X     | 5                  |                    |               |         | z                          |
| 1968   | INSECTICIDE GAS, N.O.S.   | 2.2                             |                    |                                      | X         | X     | X              | X                    | X     | 10                 |                    |               |         | z                          |
| 1969   | ISOBUTANE   | 2.1                             |                    |                                      | X         | X     | X              | X                    | X     | 10                 | 10                 | 0.49          | v       |                            |
| 1973   | CHLORODIFLUOROMETHANE AND CHLOROPENTAFLUROETHANE MIXTURE with fixed boiling point, with approximately 49% chlorodifluoromethane (REFRIGERANT GAS R 502)                   | 2.2                             |                    |                                      | X         | X     | X              | X                    | X     | 10                 | 31                 | 1.01          |         |                            |
| 1974   | CHLORODIFLUOROBROMOMETHANE (REFRIGERANT GAS R 12B1)   | 2.2                             |                    |                                      | X         | X     | X              | X                    |       | 10                 | 10                 | 1.61          |         |                            |
| 1975   | NITRIC OXIDE AND DINITROGEN TETROXIDE MIXTURE (NITRIC OXIDE AND NITROGEN DIOXIDE MIXTURE)   | 2.3                             | 5.1, 8             | 115                                  | X         |       | X              | X                    |       | 5                  |                    |               |         | k, z                       |
| 1976   | OCTAFLUOROCYCLOBUTANE (REFRIGERANT GAS RC 318)  | 2.2                             |                    |                                      | X         | X     | X              | X                    | X     | 10                 | 11                 | 1.32          |         |                            |
| 1978   | PROPANE   | 2.1                             |                    |                                      | X         | X     | X              | X                    | X     | 10                 | 23                 | 0.43          | v       |                            |
| 1982   | TETRAFLUOROMETHANE (REFRIGERANT GAS R 14)   | 2.2                             |                    |                                      | X         | X     | X              | X                    | X     | 10                 | 200<br>300         | 0.71<br>0.90  |         |                            |
| 1983   | 1-CHLORO-2,2,2-TRIFLUOROETHANE (REFRIGERANT GAS R 133a)   | 2.2                             |                    |                                      | X         | X     | X              | X                    | X     | 10                 | 10                 | 1.18          |         |                            |
| 1984   | TRIFLUOROMETHANE (REFRIGERANT GAS R 23)   | 2.2                             |                    |                                      | X         | X     | X              | X                    | X     | 10                 | 190<br>250         | 0.88<br>0.96  |         |                            |
| 2035   | 1,1,1-TRIFLUOROETHANE (REFRIGERANT GAS R 143a)  | 2.1                             |                    |                                      | X         | X     | X              | X                    | X     | 10                 | 35                 | 0.73          |         |                            |
| 2036   | XENON   | 2.2                             |                    |                                      | X         | X     | X              | X                    | X     | 10                 | 130                | 1.28          |         |                            |
| 2044   | 2,2-DIMETHYLPROPANE   | 2.1                             |                    |                                      | X         | X     | X              | X                    | X     | 10                 | 10                 | 0.53          |         |                            |
| 2073   | AMMONIA SOLUTION, relative density less than 0.880 at 15°C in water, with more than 35% but not more than 40% ammonia<br>with more than 40% but not more than 50% ammonia | 2.2                             |                    |                                      | X         | X     | X              | X                    | X     | 5                  | 10                 | 0.80          |         | b                          |
|  |   |                                 |                    |                                      | X         | X     | X              | X                    | X     | 5                  | 12                 | 0.77          |         | b                          |
| 2188   | ARSINE  | 2.3                             | 2.1                | 178                                  | X         |       |                | X                    |       | 5                  | 42                 | 1.10          | d, k    |                            |

△

4

Part 4 – Packing and tank provisions

| P200   | PACKING INSTRUCTION (continued)  |       |                             |                                      |           |       |                |                      |       |                    |                    |                      |                            | P200 |
|--|--|-------|-----------------------------|--------------------------------------|-----------|-------|----------------|----------------------|-------|--------------------|--------------------|----------------------|----------------------------|------|
| Table 2: LIQUEFIED GASES AND DISSOLVED GASES (continued) |  |       |                             |                                      |           |       |                |                      |       |                    |                    |                      |                            |      |
| UN No.   | Proper shipping name   | Class | Subsidiary hazards          | LC <sub>50</sub> , mL/m <sup>3</sup> | Cylinders | Tubes | Pressure drums | Bundles of cylinders | MEGCs | Test period, years | Test pressure, bar | Filling ratio        | Special packing provisions |      |
| 2189   | DICHLOROSILANE   | 2.3   | 2.1, 8                      | 314                                  | X         | X     | X              | X                    | X     | 5                  | 10<br>200          | 0.90<br>1.08         | a<br>a                     |      |
| 2191   | SULPHURYL FLUORIDE   | 2.3   |                             | 3,020                                | X         | X     | X              | X                    | X     | 5                  | 50                 | 1.10                 | u                          |      |
| 2192   | GERMANE  | 2.3   | 2.1                         | 620                                  | X         | X     | X              | X                    | X     | 5                  | 250                | 0.064                | d, q, r                    |      |
| 2193   | HEXAFLUOROETHANE (REFRIGERANT GAS R 116)   | 2.2   |                             |                                      | X         | X     | X              | X                    | X     | 10                 | 200                | 1.13                 |                            |      |
| 2194   | SELENIUM HEXAFLUORIDE  | 2.3   | 8                           | 50                                   | X         |       |                | X                    |       | 5                  | 36                 | 1.46                 | k                          |      |
| 2195   | TELLURIUM HEXAFLUORIDE   | 2.3   | 8                           | 25                                   | X         |       |                | X                    |       | 5                  | 20                 | 1.00                 | k                          |      |
| 2196   | TUNGSTEN HEXAFLUORIDE  | 2.3   | 8                           | 218                                  | X         | X     | X              | X                    | X     | 5                  | 10                 | 3.08                 | a                          |      |
| 2197   | HYDROGEN IODIDE, ANHYDROUS   | 2.3   | 8                           | 2,860                                | X         | X     | X              | X                    | X     | 5                  | 23                 | 2.25                 | a, d                       |      |
| 2198   | PHOSPHORUS PENTAFLUORIDE   | 2.3   | 8                           | 261                                  | X         | X     | X              | X                    | X     | 5                  | 200<br>300         | 0.90<br>1.25         |                            |      |
| 2199   | PHOSPHINE  | 2.3   | 2.1                         | 20                                   | X         |       |                | X                    |       | 5                  | 225<br>250         | 0.30<br>0.45         | d, k, q<br>d, k, q         |      |
| 2200   | PROPADIENE, STABILIZED   | 2.1   |                             |                                      | X         | X     | X              | X                    | X     | 10                 | 22                 | 0.50                 |                            |      |
| 2202   | HYDROGEN SELENIDE, ANHYDROUS   | 2.3   | 2.1                         | 51                                   | X         |       |                | X                    |       | 5                  | 31                 | 1.60                 | k                          |      |
| 2203   | SILANE   | 2.1   |                             |                                      | X         | X     | X              | X                    | X     | 10                 | 225<br>250         | 0.32<br>0.36         | q<br>q                     |      |
| 2204   | CARBONYL SULPHIDE  | 2.3   | 2.1                         | 1,700                                | X         | X     | X              | X                    | X     | 5                  | 30                 | 0.87                 | u                          |      |
| 2417   | CARBONYL FLUORIDE  | 2.3   | 8                           | 360                                  | X         | X     | X              | X                    | X     | 5                  | 200<br>300         | 0.47<br>0.70         |                            |      |
| 2418   | SULPHUR TETRAFLUORIDE  | 2.3   | 8                           | 40                                   | X         |       |                | X                    |       | 5                  | 30                 | 0.91                 | k, a                       |      |
| 2419   | BROMOTRIFLUOROETHYLENE   | 2.1   |                             |                                      | X         | X     | X              | X                    | X     | 10                 | 10                 | 1.19                 |                            |      |
| 2420   | HEXAFLUOROACETONE  | 2.3   | 8                           | 470                                  | X         | X     | X              | X                    | X     | 5                  | 22                 | 1.08                 |                            |      |
| 2421   | NITROGEN TRIOXIDE  | 2.3   | 5.1, 8                      | 57                                   | X         |       |                | X                    |       | 5                  |                    |                      | k                          |      |
| 2422   | OCTAFLUOROBUT-2-ENE (REFRIGERANT GAS R 1318)   | 2.2   |                             |                                      | X         | X     | X              | X                    | X     | 10                 | 12                 | 1.34                 |                            |      |
| 2424   | OCTAFLUOROPROPANE (REFRIGERANT GAS R 218)  | 2.2   |                             |                                      | X         | X     | X              | X                    | X     | 10                 | 25                 | 1.04                 |                            |      |
| 2451   | NITROGEN TRIFLUORIDE   | 2.2   | 5.1                         |                                      | X         | X     | X              | X                    | X     | 10                 | 200                | 0.50                 |                            |      |
| 2452   | ETHYLACETYLENE, STABILIZED   | 2.1   |                             |                                      | X         | X     | X              | X                    | X     | 10                 | 10                 | 0.57                 | c                          |      |
| 2453   | ETHYL FLUORIDE (REFRIGERANT GAS R 161)   | 2.1   |                             |                                      | X         | X     | X              | X                    | X     | 10                 | 30                 | 0.57                 |                            |      |
| 2454   | METHYL FLUORIDE (REFRIGERANT GAS R 41)   | 2.1   |                             |                                      | X         | X     | X              | X                    | X     | 10                 | 300                | 0.63                 |                            |      |
| 2455   | METHYL NITRITE   | 2.2   | (see special provision 900) |                                      |           |       |                |                      |       |                    |                    |                      |                            |      |
| 2517   | 1-CHLORO-1,1-DIFLUOROETHANE (REFRIGERANT GAS R 142b)   | 2.1   |                             |                                      | X         | X     | X              | X                    | X     | 10                 | 10                 | 0.99                 |                            |      |
| 2534   | METHYLCHLOROSILANE   | 2.3   | 2.1, 8                      | 2,810                                | X         | X     | X              | X                    | X     | 5                  |                    |                      | z                          |      |
| 2548   | CHLORINE PENTAFLUORIDE   | 2.3   | 5.1, 8                      | 122                                  | X         |       |                | X                    |       | 5                  | 13                 | 1.49                 | a, k                       |      |
| 2599   | CHLOROTRIFLUOROMETHANE AND TRIFLUOROMETHANE AZEOTROPIC MIXTURE with approximately 60% chlorotrifluoromethane (REFRIGERANT GAS R 503) | 2.2   |                             |                                      | X         | X     | X              | X                    | X     | 10                 | 31<br>42<br>100    | 0.12<br>0.17<br>0.64 |                            |      |
| 2601   | CYCLOBUTANE  | 2.1   |                             |                                      | X         | X     | X              | X                    | X     | 10                 | 10                 | 0.63                 |                            |      |
| 2602   | DICHLORODIFLUOROMETHANE AND DIFLUOROETHANE AZEOTROPIC MIXTURE with approximately 74% dichlorodifluoromethane (REFRIGERANT GAS R 500) | 2.2   |                             |                                      | X         | X     | X              | X                    | X     | 10                 | 22                 | 1.01                 |                            |      |
| 2676   | STIBINE  | 2.3   | 2.1                         | 178                                  | X         |       |                | X                    |       | 5                  | 200                | 0.49                 | k, r                       |      |

Chapter 4.1 – Use of packagings, including IBCs and large packagings

| P200   |   | PACKING INSTRUCTION (continued) |                    |                                      |           |       |                |                      |       |                    |                    |               | P200                       |  |
|--|---|---------------------------------|--------------------|--------------------------------------|-----------|-------|----------------|----------------------|-------|--------------------|--------------------|---------------|----------------------------|--|
| Table 2: LIQUEFIED GASES AND DISSOLVED GASES (continued) |   |                                 |                    |                                      |           |       |                |                      |       |                    |                    |               |                            |  |
| UN No.   | Proper shipping name  | Class                           | Subsidiary hazards | LC <sub>50</sub> , mL/m <sup>3</sup> | Cylinders | Tubes | Pressure drums | Bundles of cylinders | MEGCs | Test period, years | Test pressure, bar | Filling ratio | Special packing provisions |  |
|  |   |                                 |                    |                                      |           |       |                |                      |       |                    |                    |               |                            |  |
| 2901   | BROMINE CHLORIDE  | 2.3                             | 5.1, 8             | 290                                  | X         | X     | X              | X                    | X     | 5                  | 10                 | 1.50          | a                          |  |
| 3057   | TRIFLUOROACETYL CHLORIDE  | 2.3                             | 8                  | 10                                   | X         |       | X              | X                    |       | 5                  | 17                 | 1.17          | k                          |  |
| 3070   | ETHYLENE OXIDE AND DICHLORODIFLUOROMETHANE MIXTURE with not more than 12.5% ethylene oxide      | 2.2                             |                    |                                      | X         | X     | X              | X                    | X     | 10                 | 18                 | 1.09          |                            |  |
| 3083   | PERCHLORYL FLUORIDE   | 2.3                             | 5.1                | 770                                  | X         | X     | X              | X                    | X     | 5                  | 33                 | 1.21          | u                          |  |
| 3153   | PERFLUORO(METHYL VINYL ETHER)   | 2.1                             |                    |                                      | X         | X     | X              | X                    | X     | 10                 | 20                 | 0.75          |                            |  |
| 3154   | PERFLUORO(ETHYL VINYL ETHER)  | 2.1                             |                    |                                      | X         | X     | X              | X                    | X     | 10                 | 10                 | 0.98          |                            |  |
| 3157   | LIQUEFIED GAS, OXIDIZING, N.O.S.  | 2.2                             | 5.1                |                                      | X         | X     | X              | X                    | X     | 10                 |                    |               | z                          |  |
| 3159   | 1,1,1,2-TETRAFLUOROETHANE (REFRIGERANT GAS R 134a)  | 2.2                             |                    |                                      | X         | X     | X              | X                    | X     | 10                 | 18                 | 1.05          |                            |  |
| 3160   | LIQUEFIED GAS, TOXIC, FLAMMABLE, N.O.S.   | 2.3                             | 2.1                | ≤ 5,000                              | X         | X     | X              | X                    | X     | 5                  |                    |               | z                          |  |
| 3161   | LIQUEFIED GAS, FLAMMABLE, N.O.S.  | 2.1                             |                    |                                      | X         | X     | X              | X                    | X     | 10                 |                    |               | z                          |  |
| 3162   | LIQUEFIED GAS, TOXIC, N.O.S.  | 2.3                             |                    | ≤ 5,000                              | X         | X     | X              | X                    | X     | 5                  |                    |               | z                          |  |
| 3163   | LIQUEFIED GAS, N.O.S.   | 2.2                             |                    |                                      | X         | X     | X              | X                    | X     | 10                 |                    |               | z                          |  |
| 3220   | PENTAFLUOROETHANE (REFRIGERANT GAS R 125)   | 2.2                             |                    |                                      | X         | X     | X              | X                    | X     | 10                 | 49<br>35           | 0.95<br>0.87  |                            |  |
| 3252   | DIFLUOROMETHANE (REFRIGERANT GAS R 32)  | 2.1                             |                    |                                      | X         | X     | X              | X                    | X     | 10                 | 48                 | 0.78          |                            |  |
| 3296   | HEPTAFLUOROPROPANE (REFRIGERANT GAS R 227)  | 2.2                             |                    |                                      | X         | X     | X              | X                    | X     | 10                 | 13                 | 1.21          |                            |  |
| 3297   | ETHYLENE OXIDE AND CHLOROTETRAFLUOROETHANE MIXTURE with not more than 8.8% ethylene oxide       | 2.2                             |                    |                                      | X         | X     | X              | X                    | X     | 10                 | 10                 | 1.16          |                            |  |
| 3298   | ETHYLENE OXIDE AND PENTAFLUOROETHANE MIXTURE with not more than 7.9% ethylene oxide             | 2.2                             |                    |                                      | X         | X     | X              | X                    | X     | 10                 | 26                 | 1.02          |                            |  |
| 3299   | ETHYLENE OXIDE AND TETRAFLUOROETHANE MIXTURE with not more than 5.6% ethylene oxide             | 2.2                             |                    |                                      | X         | X     | X              | X                    | X     | 10                 | 17                 | 1.03          |                            |  |
| 3300   | ETHYLENE OXIDE AND CARBON DIOXIDE MIXTURE with more than 87% ethylene oxide                     | 2.3                             | 2.1                | More than 2,900                      | X         | X     | X              | X                    | X     | 5                  | 28                 | 0.73          |                            |  |
| 3307   | LIQUEFIED GAS, TOXIC, OXIDIZING, N.O.S.   | 2.3                             | 5.1                | ≤ 5,000                              | X         | X     | X              | X                    | X     | 5                  |                    |               | z                          |  |
| 3308   | LIQUEFIED GAS, TOXIC, CORROSIVE, N.O.S.   | 2.3                             | 8                  | ≤ 5,000                              | X         | X     | X              | X                    | X     | 5                  |                    |               | z                          |  |
| 3309   | LIQUEFIED GAS, TOXIC, FLAMMABLE, CORROSIVE, N.O.S.  | 2.3                             | 2.1, 8             | ≤ 5,000                              | X         | X     | X              | X                    | X     | 5                  |                    |               | z                          |  |
| 3310   | LIQUEFIED GAS, TOXIC, OXIDIZING, CORROSIVE, N.O.S.  | 2.3                             | 5.1, 8             | ≤ 5,000                              | X         | X     | X              | X                    | X     | 5                  |                    |               | z                          |  |
| 3318   | AMMONIA SOLUTION, relative density less than 0.880 at 15°C in water, with more than 50% ammonia | 2.3                             | 8                  |                                      | X         | X     | X              | X                    |       | 5                  |                    |               | b                          |  |
| 3337   | REFRIGERANT GAS R 404A  | 2.2                             |                    |                                      | X         | X     | X              | X                    | X     | 10                 | 36                 | 0.82          |                            |  |
| 3338   | REFRIGERANT GAS R 407A  | 2.2                             |                    |                                      | X         | X     | X              | X                    | X     | 10                 | 32                 | 0.94          |                            |  |
| 3339   | REFRIGERANT GAS R 407B  | 2.2                             |                    |                                      | X         | X     | X              | X                    | X     | 10                 | 33                 | 0.93          |                            |  |
| 3340   | REFRIGERANT GAS R 407C  | 2.2                             |                    |                                      | X         | X     | X              | X                    | X     | 10                 | 30                 | 0.95          |                            |  |
| 3354   | INSECTICIDE GAS, FLAMMABLE, N.O.S.  | 2.1                             |                    |                                      | X         | X     | X              | X                    | X     | 10                 |                    |               | z                          |  |
| 3355   | INSECTICIDE GAS, TOXIC, FLAMMABLE, N.O.S.   | 2.3                             | 2.1                |                                      | X         | X     | X              | X                    | X     | 5                  |                    |               | z                          |  |
| 3374   | ACETYLENE, SOLVENT FREE   | 2.1                             |                    |                                      | X         |       |                | X                    |       | 5                  | 60<br>52           |               | c, p<br>c, p               |  |
| 3553   | DISILANE  | 2.1                             |                    |                                      | X         | X     | X              | X                    |       | 10                 | 225                | 0.39          | q                          |  |



Part 4 – Packing and tank provisions

| P200                               |  | PACKING INSTRUCTION (continued) |                    |                                      |           |       |                |                      |       |                    |                    |               | P200                       |
|------------------------------------|--|---------------------------------|--------------------|--------------------------------------|-----------|-------|----------------|----------------------|-------|--------------------|--------------------|---------------|----------------------------|
| Table 3: SUBSTANCES NOT IN CLASS 2 |  |                                 |                    |                                      |           |       |                |                      |       |                    |                    |               |                            |
| UN No.                             | Proper shipping name                                       | Class                           | Subsidiary hazards | LC <sub>50</sub> , mL/m <sup>3</sup> | Cylinders | Tubes | Pressure drums | Bundles of cylinders | MEGCs | Test period, years | Test pressure, bar | Filling ratio | Special packing provisions |
| 1051                               | HYDROGEN CYANIDE, STABILIZED containing less than 3% water | 6.1                             | 3                  | 40                                   | X         |       |                | X                    |       | 5                  | 100                | 0.55          | k                          |
| 1052                               | HYDROGEN FLUORIDE, ANHYDROUS                               | 8                               | 6.1                | 1307                                 | X         |       | X              | X                    |       | 5                  | 10                 | 0.84          | t, a                       |
| 1745                               | BROMINE PENTAFLUORIDE                                      | 5.1                             | 6.1, 8             | 25                                   | X         |       | X              | X                    |       | 5                  | 10                 | *             | k                          |
| 1746                               | BROMINE TRIFLUORIDE  | 5.1                             | 6.1, 8             | 50                                   | X         |       | X              | X                    |       | 5                  | 10                 | *             | k                          |
| 2495                               | IODINE PENTAFLUORIDE                                       | 5.1                             | 6.1, 8             | 120                                  | X         |       | X              | X                    |       | 5                  | 10                 | *             | k                          |

\* A minimum ullage of 8% by volume is required.

| P201  |  | PACKING INSTRUCTION |  |  |  |  |  |  |  |  |  |  | P201 |
|---|--|---------------------|--|--|--|--|--|--|--|--|--|--|------|
| This instruction applies to UN Nos. 3167, 3168 and 3169.  |  |                     |  |  |  |  |  |  |  |  |  |  |      |
| The following packagings are authorized:  |  |                     |  |  |  |  |  |  |  |  |  |  |      |
| <ul style="list-style-type: none"> <li>(1) Cylinders and gas receptacles conforming to the construction, testing and filling requirements approved by the competent authority.</li> <li>(2) The following combination packagings provided that the general provisions of 4.1.1 and 4.1.3 are met: <ul style="list-style-type: none"> <li>Outer packagings: <ul style="list-style-type: none"> <li>Drums (1A1, 1A2, 1B1, 1B2, 1N1, 1N2, 1H1, 1H2, 1D, 1G);</li> <li>Boxes (4A, 4B, 4N, 4C1, 4C2, 4D, 4F, 4G, 4H1, 4H2);</li> <li>Jerricans (3A1, 3A2, 3B1, 3B2, 3H1, 3H2).</li> </ul> </li> <li>Inner packagings: <ul style="list-style-type: none"> <li>(a) For non-toxic gases, hermetically sealed inner packagings of glass or metal with a maximum capacity of 5 L per package;</li> <li>(b) For toxic gases, hermetically sealed inner packagings of glass or metal with a maximum capacity of 1 L per package.</li> </ul> </li> </ul> </li> </ul> |  |                     |  |  |  |  |  |  |  |  |  |  |      |
| Packagings shall conform to the packing group III performance level.  |  |                     |  |  |  |  |  |  |  |  |  |  |      |
| P202  |  | PACKING INSTRUCTION |  |  |  |  |  |  |  |  |  |  | P202 |
| [Reserved]  |  |                     |  |  |  |  |  |  |  |  |  |  |      |



Chapter 4.1 – Use of packagings, including IBCs and large packagings

| P203  | PACKING INSTRUCTION  | P203 |
|---|--|------|
| This instruction applies to class 2 refrigerated liquefied gases. |  |      |
| <b>Requirements for closed cryogenic receptacles:</b>             |  |      |
|   | (1) The general requirements of 4.1.6.1 shall be met.  |      |
|   | (2) The requirements of chapter 6.2 shall be met.  |      |
|   | (3) The closed cryogenic receptacles shall be so insulated that they do not become coated with frost.  |      |
|   | (4) Test pressure<br>Refrigerated liquids shall be filled in closed cryogenic receptacles with the following minimum test pressures:   |      |
|   | (a) For closed cryogenic receptacles with vacuum insulation, the test pressure shall not be less than 1.3 times the sum of the maximum internal pressure of the filled receptacle, including during filling and discharge, plus 100 kPa (1 bar);   |      |
|   | (b) For other closed cryogenic receptacles, the test pressure shall be not less than 1.3 times the maximum internal pressure of the filled receptacle, taking into account the pressure developed during filling and discharge.  |      |
| △   | (5) Filling<br>For non-flammable, non-toxic refrigerated liquefied gases the volume of liquid phase at the filling temperature and at a pressure of 100 kPa (1 bar) shall not exceed 98% of the water capacity of the pressure receptacle.   |      |
| △   | For flammable refrigerated liquefied gases the gas filled into the receptacle shall remain below the level at which, if the contents were raised to the temperature at which the vapour pressure equalled the opening pressure of the relief valve, the volume of the liquid phase would reach 98% of the water capacity at that temperature.        |      |
|   | (6) Pressure-relief devices<br>Closed cryogenic receptacles shall be fitted with at least one pressure-relief device.  |      |
|   | (7) Compatibility<br>Materials used to ensure the leakproofness of the joints or for the maintenance of the closures shall be compatible with the contents. In the case of receptacles intended for the transport of oxidizing gases (i.e. with a subsidiary hazard of 5.1), these materials shall not react with these gases in a dangerous manner. |      |
|   | (8) Periodic inspection<br>The periodic inspection and test frequencies of pressure relief valves in accordance with 6.2.1.6.3 shall not exceed five years.  |      |
| <b>Requirements for open cryogenic receptacles:</b>               |  |      |
| △   | Only the following non-oxidizing refrigerated liquefied gases of class 2.2 may be transported in open cryogenic receptacles: UN Nos. 1913, 1951, 1963, 1970, 1977, 2591, 3136 and 3158. For these gases, when used as a coolant, the requirements of 5.5.3 shall apply.  |      |
|   | Open cryogenic receptacles shall be constructed to meet the following requirements:  |      |
|   | (1) The receptacles shall be designed, manufactured, tested and equipped in such a way as to withstand all conditions, including fatigue, to which they will be subjected during their normal use and during normal conditions of transport.   |      |
|   | (2) The capacity shall be not more than 450 L.   |      |
|   | (3) The receptacle shall have a double wall construction with the space between the inner and outer wall being evacuated (vacuum insulation). The insulation shall prevent the formation of hoar frost on the exterior of the receptacle.  |      |
|   | (4) The materials of construction shall have suitable mechanical properties at the service temperature.  |      |
|   | (5) Materials which are in direct contact with the dangerous goods shall not be affected or weakened by the dangerous goods intended to be transported and shall not cause a dangerous effect, e.g. catalysing a reaction or reacting with the dangerous goods.  |      |
|   | (6) Receptacles of glass double wall construction shall have an outer packaging with suitable cushioning or absorbent materials which withstand the pressures and impacts liable to occur under normal conditions of transport.  |      |
|   | (7) The receptacle shall be designed to remain in an upright position during transport, e.g. have a base whose smaller horizontal dimension is greater than the height of the centre of gravity when filled to capacity or be mounted on gimbals.  |      |
|   | (8) The openings of the receptacles shall be fitted with devices allowing gases to escape, preventing any splashing out of liquid, and so configured that they remain in place during transport.   |      |
|   | (9) Open cryogenic receptacles shall bear the following marks permanently affixed, e.g. by stamping, engraving or etching:   |      |
|   | (a) The manufacturer's name and address;   |      |
|   | (b) The model number or name;  |      |
|   | (c) The serial or batch number;  |      |
|   | (d) The UN number and proper shipping name of gases for which the receptacle is intended;  |      |
|   | (e) The capacity of the receptacle in litres.  |      |





Part 4 – Packing and tank provisions

| P205  | PACKING INSTRUCTION | P205 |
|---|---------------------|------|
| This instruction applies to UN 3468.  |                     |      |
| <p>(1) For metal hydride storage systems, the general packing requirements of 4.1.6.1 shall be met.</p> <p>(2) Only pressure receptacles not exceeding 150 L in water capacity and having a maximum developed pressure not exceeding 25 MPa are covered by this packing instruction.</p> <p>(3) Metal hydride storage systems meeting the applicable requirements for the construction and testing of pressure receptacles containing gas of chapter 6.2 are authorized for the transport of hydrogen only.</p> <p>(4) When steel pressure receptacles or composite pressure receptacles with steel liners are used, only those bearing the "H" mark, in accordance with 6.2.2.9.2(j), shall be used.</p> <p>(5) Metal hydride storage systems shall meet the service conditions, design criteria, rated capacity, type tests, batch tests, routine tests, test pressure, rated charging pressure and provisions for pressure relief devices for transportable metal hydride storage systems specified in ISO 16111:2008 or ISO 16111:2018 and their conformity and approval shall be assessed in accordance with 6.2.2.5.</p> <p>(6) Metal hydride storage systems shall be filled with hydrogen at a pressure not exceeding the rated charging pressure shown in the permanent mark on the system as specified by ISO 16111:2008 or ISO 16111:2018.</p> <p>(7) The periodic test requirements for a metal hydride storage system shall be in accordance with ISO 16111:2008 or ISO 16111:2018 and carried out in accordance with 6.2.2.6, and the interval between periodic inspections shall not exceed five years. See 6.2.2.4 to determine which standard is applicable at the time of periodic inspection and test.</p> |                     |      |

| P206  | PACKING INSTRUCTION | P206 |
|---|---------------------|------|
| This instruction applies to UN Nos. 3500, 3501, 3502, 3503, 3504 and 3505.  |                     |      |
| <p>Unless otherwise indicated in these provisions, cylinders and pressure drums conforming to the applicable requirements of Chapter 6.2 are authorized.</p> <p>(1) The general packing requirements of 4.1.6.1 shall be met.</p> <p>(2) The maximum test period for periodic inspection shall be 5 years.</p> <p>(3) Cylinders and pressure drums shall be so filled that at 50°C the non-gaseous phase does not exceed 95% of their water capacity and they are not completely filled at 60°C. When filled, the internal pressure at 65°C shall not exceed the test pressure of the cylinders and pressure drums. The vapour pressures and volumetric expansion of all substances in the cylinders and pressure drums shall be taken into account. For liquids charged with a compressed gas both components – the liquid and the compressed gas – have to be taken into consideration in the calculation of the internal pressure in the pressure receptacle. When experimental data is not available, the following steps shall be carried out:</p> <p>(a) calculation of the vapour pressure of the liquid and of the partial pressure of the compressed gas at 15°C (filling temperature);</p> <p>(b) calculation of the volumetric expansion of the liquid phase resulting from the heating from 15°C to 65°C and calculation of the remaining volume for the gaseous phase;</p> <p>(c) calculation of the partial pressure of the compressed gas at 65°C considering the volumetric expansion of the liquid phase;</p> <p><b>Note:</b> The compressibility factor of the compressed gas at 15°C and 65°C shall be considered.</p> <p>(d) calculation of the vapour pressure of the liquid at 65°C;</p> <p>(e) the total pressure is the sum of the vapour pressure of the liquid and the partial pressure of the compressed gas at 65°C;</p> <p>(f) consideration of the solubility of the compressed gas at 65°C in the liquid phase.</p> <p>The test pressure of the cylinders or pressure drums shall not be less than the calculated total pressure minus 100 kPa (1bar).</p> <p>If the solubility of the compressed gas in the liquid phase is not known for the calculation, the test pressure can be calculated without taking the gas solubility (subparagraph (f)) into account.</p> <p>(4) The minimum test pressure shall be in accordance with P200 for the propellant but shall not be less than 20 bar.</p> |                     |      |
| <p><b>Additional requirement:</b></p> <p>Cylinders and pressure drums shall not be offered for transport when connected with spray application equipment such as a hose and wand assembly.</p>  |                     |      |
| <p><b>Special packing provisions:</b></p> <p>△ <b>PP89</b> For UN Nos. 3501, 3502, 3503, 3504 and 3505, notwithstanding 4.1.6.1.9.2, non-refillable cylinders used may have a water capacity in L not exceeding 1 000L divided by the test pressure expressed in bars provided capacity and pressure restrictions of the construction standard comply with clause 1 of ISO 11118:2015 + Amd 1:2019, which limits the maximum capacity to 50L.</p> <p><b>PP97</b> For fire-extinguishing agents assigned to UN 3500 the maximum test period for periodic inspection shall be 10 years. They may be transported in tubes of a maximum water capacity of 450 L conforming to the applicable requirements of chapter 6.2.</p>   |                     |      |



Chapter 4.1 – Use of packagings, including IBCs and large packagings

| P207  | PACKING INSTRUCTION | P207 |
|---|---------------------|------|
| This instruction applies to UN 1950.  |                     |      |
| <p>The following packagings are authorized, provided that the general provisions of 4.1.1 and 4.1.3 are met:</p> <p>(a) Drums (1A1, 1A2, 1B1, 1B2, 1N1, 1N2, 1H1, 1H2, 1D, 1G);<br/>Boxes (4A, 4B, 4N, 4C1, 4C2, 4D, 4F, 4G, 4H1, 4H2).<br/>Packagings shall conform to the packing group II performance level.</p> <p>(b) Rigid outer packagings with a maximum net mass as follows:<br/>Fibreboard                    55 kg<br/>Other than fibreboard      125 kg<br/>The provisions of 4.1.1.3 need not be met.</p> <p>The packagings shall be designed and constructed to prevent excessive movement of the aerosols and inadvertent discharge during normal conditions of transport.</p>   |                     |      |
| <p><b>Special packing provision:</b><br/> <b>PP87</b> For UN 1950, waste aerosols transported in accordance with special provision 327, the packagings shall have a means of retaining any free liquid that might escape during transport, e.g. absorbent material. The packaging shall be adequately ventilated to prevent the creation of dangerous atmospheres and the build-up of pressure.</p>   |                     |      |
| P208  | PACKING INSTRUCTION | P208 |
| This instruction applies to class 2 adsorbed gases.   |                     |      |
| <p>(1) The following packagings are authorized provided the general packing requirements of 4.1.6.1 are met:</p> <p>(a) cylinders constructed as specified in 6.2.2 and in accordance with ISO 11513:2011, ISO 11513:2019, ISO 9809-1:2010 or ISO 9809-1:2019; and</p> <p>(b) cylinders constructed before 1 January 2016 in accordance with 6.2.3 and a specification approved by the competent authorities of the countries of transport and use.</p> <p>(2) The pressure of each filled cylinder shall be less than 101.3 kPa at 20°C and less than 300 kPa at 50°C.</p> <p>(3) The minimum test pressure of the cylinder shall be 21 bar.</p> <p>(4) The minimum burst pressure of the cylinder shall be 94.5 bar.</p> <p>(5) The internal pressure at 65°C of the filled cylinder shall not exceed the test pressure of the cylinder.</p> <p>(6) The adsorbent material shall be compatible with the cylinder and shall not form harmful or dangerous compounds with the gas to be adsorbed. The gas in combination with the adsorbent material shall not affect or weaken the cylinder or cause a dangerous reaction (e.g. a catalyzing reaction).</p> <p>(7) The quality of the adsorbent material shall be verified at the time of each fill to assure the pressure and chemical stability requirements of this packing instruction are met each time an adsorbed gas package is offered for transport.</p> <p>(8) The adsorbent material shall not meet the criteria of any of the classes or divisions in this Code.</p> <p>(9) Requirements for cylinders and closures containing toxic gases with an LC<sub>50</sub> less than or equal to 200 mL/m<sup>3</sup> (ppm) (see table 1) shall be as follows:</p> <p>(a) Valve outlets shall be fitted with pressure retaining gas-tight plugs or caps having threads matching those of the valve outlets.</p> <p>(b) Each valve shall either be of the packless type with non-perforated diaphragm, or be of a type which prevents leakage through or past the packing.</p> <p>(c) Each cylinder and closure shall be tested for leakage after filling.</p> <p>(d) Each valve shall be capable of withstanding the test pressure of the cylinder and be directly connected to the cylinder by either a taper-thread or other means which meets the requirements of ISO 10692-2:2001.</p> <p>(e) Cylinders and valves shall not be fitted with a pressure relief device.</p> <p>(10) Valve outlets for cylinders containing pyrophoric gases shall be fitted with gas-tight plugs or caps having threads matching those of the valve outlets.</p> <p>(11) The filling procedure shall be in accordance with annex A of ISO 11513:2011 (applicable until 31 December 2024) or annex A of ISO 11513:2019.</p> <p>(12) The maximum period for periodic inspections shall be 5 years.</p> <p>(13) Special packing provisions that are specific to a substance (see table 1).</p> <p><i>Material compatibility</i></p> <p>a: Aluminium alloy cylinders shall not be used.</p> <p>d: When steel cylinders are used, only those bearing the “H” mark in accordance with 6.2.2.7.4 (p) are permitted.</p> <p><i>Gas specific provisions</i></p> <p>r: The filling ratio of this gas shall be limited such that, if complete decomposition occurs, the pressure does not exceed two thirds of the test pressure of the cylinder.</p> <p><i>Material compatibility for N.O.S. adsorbed gas entries</i></p> <p>z: The construction materials of the cylinders and their accessories shall be compatible with the contents and shall not react to form harmful or dangerous compounds therewith.</p> |                     |      |



Part 4 – Packing and tank provisions

| P208                    |   | PACKING INSTRUCTION (continued) |                   |                                    |                            | P208 |
|-------------------------|---|---------------------------------|-------------------|------------------------------------|----------------------------|------|
| Table 1: ADSORBED GASES |   |                                 |                   |                                    |                            |      |
| UN No.                  | Proper shipping name                              | Class or Division               | Subsidiary hazard | LC <sub>50</sub> mL/m <sup>3</sup> | Special packing provisions |      |
| ⊗                       |   |                                 |                   |                                    |                            |      |
| 3510                    | ADSORBED GAS, FLAMMABLE, N.O.S.                   | 2.1                             |                   |                                    | z                          |      |
| 3511                    | ADSORBED GAS, N.O.S.                              | 2.2                             |                   |                                    | z                          |      |
| 3512                    | ADSORBED GAS, TOXIC, N.O.S.                       | 2.3                             |                   | ≤ 5,000                            | z                          |      |
| 3513                    | ADSORBED GAS, OXIDIZING, N.O.S.                   | 2.2                             | 5.1               |                                    | z                          |      |
| 3514                    | ADSORBED GAS, TOXIC, FLAMMABLE, N.O.S.            | 2.3                             | 2.1               | ≤ 5,000                            | z                          |      |
| 3515                    | ADSORBED GAS, TOXIC, OXIDIZING, N.O.S.            | 2.3                             | 5.1               | ≤ 5,000                            | z                          |      |
| 3516                    | ADSORBED GAS, TOXIC, CORROSIVE, N.O.S.            | 2.3                             | 8                 | ≤ 5,000                            | z                          |      |
| 3517                    | ADSORBED GAS, TOXIC, FLAMMABLE, CORROSIVE, N.O.S. | 2.3                             | 2.1<br>8          | ≤ 5,000                            | z                          |      |
| 3518                    | ADSORBED GAS, TOXIC, OXIDIZING, CORROSIVE, N.O.S. | 2.3                             | 5.1<br>8          | ≤ 5,000                            | z                          |      |
| 3519                    | BORON TRIFLUORIDE, ADSORBED                       | 2.3                             | 8                 | 387                                | a                          |      |
| 3520                    | CHLORINE, ADSORBED                                | 2.3                             | 5.1<br>8          | 293                                | a                          |      |
| 3521                    | SILICON TETRAFLUORIDE, ADSORBED                   | 2.3                             | 8                 | 450                                | a                          |      |
| 3522                    | ARSINE, ADSORBED                                  | 2.3                             | 2.1               | 20                                 | d                          |      |
| 3523                    | GERMANE, ADSORBED                                 | 2.3                             | 2.1               | 620                                | d, r                       |      |
| 3524                    | PHOSPHORUS PENTAFLUORIDE, ADSORBED                | 2.3                             | 8                 | 190                                |                            |      |
| 3525                    | PHOSPHINE, ADSORBED                               | 2.3                             | 2.1               | 20                                 | d                          |      |
| 3526                    | HYDROGEN SELENIDE, ADSORBED                       | 2.3                             | 2.1               | 2                                  |                            |      |

| P300  |  | PACKING INSTRUCTION |  | P300 |
|---|--|---------------------|--|------|
| This instruction applies to UN 3064.  |  |                     |  |      |
| The following packagings are authorized, provided that the general provisions of 4.1.1 and 4.1.3 are met:<br>Combination packagings consisting of inner metal cans of not more than 1 L capacity each and outer wooden boxes (4C1, 4C2, 4D or 4F) containing not more than 5 L of solution. |  |                     |  |      |
| <b>Additional provisions:</b>   |  |                     |  |      |
| 1 Metal cans shall be completely surrounded with absorbent cushioning material.   |  |                     |  |      |
| 2 Wooden boxes shall be completely lined with suitable material impervious to water and nitroglycerin.  |  |                     |  |      |

| P301                                 |  | PACKING INSTRUCTION |  | P301 |
|--------------------------------------|--|---------------------|--|------|
| This instruction applies to UN 3165. |  |                     |  |      |
| △                                    | The following packagings are authorized, provided that the general provisions of 4.1.1.1, 4.1.1.2, 4.1.1.4, 4.1.1.5, 4.1.1.6 and 4.1.3 are met:  |                     |  |      |
|                                      | (1) Aluminium pressure receptacle made from tubing and having welded heads<br>Primary containment of the fuel within this receptacle shall consist of a welded aluminium bladder having a maximum internal volume of 46 L. The outer receptacle shall have a minimum design gauge pressure of 1,275 kPa and a minimum burst gauge pressure of 2,755 kPa. Each receptacle shall be leak-checked during manufacture and before shipment and shall be found leakproof. The complete inner unit shall be securely packed in non-combustible cushioning material, such as vermiculite, in a strong outer tightly closed metal packaging which will adequately protect all fittings. Maximum quantity of fuel per primary containment and package is 42 L. |                     |  |      |
|                                      | (2) Aluminium pressure receptacle<br>Primary containment of the fuel within this receptacle shall consist of a welded vapourtight fuel compartment with an elastomeric bladder having a maximum internal volume of 46 L. The pressure receptacle shall have a minimum design gauge pressure of 2,680 kPa and a minimum burst pressure of 5,170 kPa. Each receptacle shall be leak-checked during manufacture and before shipment and shall be securely packed in non-combustible cushioning material such as vermiculite, in a strong outer tightly closed metal packaging which will adequately protect all fittings. Maximum quantity of fuel per primary containment and package is 42 L.   |                     |  |      |



Chapter 4.1 – Use of packagings, including IBCs and large packagings

| P302  | PACKING INSTRUCTION | P302 |
|---|---------------------|------|
| This instruction applies to UN 3269.  |                     |      |
| <p>The following combination packagings are authorized, provided that the general provisions of 4.1.1 and 4.1.3 are met:</p> <p>Outer packagings:</p> <p style="padding-left: 20px;">Drums (1A1, 1A2, 1B1, 1B2, 1N1, 1N2, 1H1, 1H2, 1D, 1G).<br/>Boxes (4A, 4B, 4N, 4C1, 4C2, 4D, 4F, 4G, 4H1, 4H2).<br/>Jerricans (3A1, 3A2, 3B1, 3B2, 3H1, 3H2).</p> <p>Inner packagings:</p> <p style="padding-left: 20px;">The activator (organic peroxide) shall have a maximum quantity of 125 ml per inner packaging if liquid, and 500 g per inner packaging if solid.<br/>The base material and the activator shall be each separately packed in inner packagings.</p> <p>The components may be placed in the same outer packaging provided that they will not interact dangerously in the event of a leakage.</p> <p>Packagings shall conform to the packing group II or III performance level according to the criteria for Class 3 applied to the base material.</p>  |                     |      |
| P303  | PACKING INSTRUCTION | P303 |
| This instruction applies to UN 3555.  |                     |      |
| <p>The following packagings are authorized, provided that the general provisions of 4.1.1 and 4.1.3 as well as 4.1.5.12 are met:</p> <p style="padding-left: 20px;">Plastics drum non-removeable head (1H1) of maximum capacity 250 L.</p>  |                     |      |
| <b>Additional requirement:</b>  |                     |      |
| The packagings shall be transported in an upright position.   |                     |      |
| <b>Special packing provision:</b>   |                     |      |
| PP26 For UN 3555, packagings shall be lead free.  |                     |      |
| P400  | PACKING INSTRUCTION | P400 |
| <p>The following packagings are authorized, provided that the general provisions of 4.1.1 and 4.1.3 are met:</p> <p>(1) Pressure receptacles, provided that the general provisions of 4.1.3.6 are met. They shall be made of steel and shall be subjected to an initial test and periodic tests every 10 years at a pressure of not less than 1 MPa (10 bar, gauge pressure). During carriage, the liquid shall be under a layer of inert gas with a gauge pressure of not less than 20 kPa (0.2 bar).</p> <p>(2) Boxes (4A, 4B, 4N, 4C1, 4C2, 4D, 4F or 4G), drums (1A1, 1A2, 1B1, 1B2, 1N1, 1N2, 1D or 1G) or jerricans (3A1, 3A2, 3B1 or 3B2) enclosing hermetically sealed metal cans with inner packagings of glass or metal, with a capacity of not more than 1 L each, having closures with gaskets. Inner packagings shall have threaded closures or closures physically held in place by any means capable of preventing back-off or loosening of the closure by impact or vibration during transport. Inner packagings shall be cushioned on all sides with dry, absorbent, non-combustible material in a quantity sufficient to absorb the entire contents. Inner packagings shall not be filled to more than 90% of their capacity. Outer packagings shall have a maximum net mass of 125 kg.</p> <p>(3) Steel, aluminium or metal drums (1A1, 1A2, 1B1, 1B2, 1N1 or 1N2), jerricans (3A1, 3A2, 3B1 or 3B2) or boxes (4A, 4B or 4N) with a maximum net mass of 150 kg each with hermetically sealed inner metal cans of not more than 4 L capacity each, with closures fitted with gaskets. Inner packagings shall have threaded closures or closures physically held in place by any means capable of preventing back-off or loosening of the closure by impact or vibration during transport. Inner packagings shall be cushioned on all sides with dry, absorbent, non-combustible material in a quantity sufficient to absorb the entire contents. Each layer of inner packagings shall be separated by a dividing partition in addition to cushioning material. Inner packagings shall not be filled to more than 90% of their capacity.</p> |                     |      |
| <b>Special packing provision:</b>   |                     |      |
| PP86 For UN Nos. 3392 and 3394, air shall be eliminated from the vapour space by nitrogen or other means.   |                     |      |

Part 4 – Packing and tank provisions

| P401   | PACKING INSTRUCTION | P401 |
|--|---------------------|------|
| <p>The following packagings are authorized, provided that the general provisions of 4.1.1 and 4.1.3 are met:</p> <p>(1) Pressure receptacles, provided that the general provisions of 4.1.3.6 are met. They shall be made of steel and subjected to an initial test and periodic tests every 10 years at a pressure of not less than 0.6 MPa (6 bar, gauge pressure). During carriage, the liquid shall be under a layer of inert gas with a gauge pressure of not less than 20 kPa (0.2 bar).</p> <p>(2) Combination packagings<br/>Outer packagings:<br/>Drums (1A1, 1A2, 1B1, 1B2, 1N1, 1N2, 1H1, 1H2, 1D, 1G);<br/>Boxes (4A, 4B, 4N, 4C1, 4C2, 4D, 4F, 4G, 4H1,4H2);<br/>Jerricans (3A1, 3A2, 3B1, 3B2, 3H1, 3H2).<br/>Inner packagings:<br/>Glass, metal or plastics which have threaded closures with a maximum capacity of 1 L.<br/>Each inner packaging shall be surrounded by inert cushioning and absorbent material in a quantity sufficient to absorb the entire contents.<br/>The maximum net mass per outer packaging shall not exceed 30 kg.</p> |                     |      |
| <p><b>Special packing provision:</b><br/><b>PP31</b> For UN Nos. 1183, 1242, 1295, 2965 and 2988, packagings shall be hermetically sealed.</p>   |                     |      |

| P402  | PACKING INSTRUCTION | P402 |
|---|---------------------|------|
| <p>The following packagings are authorized, provided that the general provisions of 4.1.1 and 4.1.3 are met:</p> <p>(1) Pressure receptacles, provided that the general provisions of 4.1.3.6 are met. They shall be made of steel and subjected to an initial test and periodic tests every 10 years at a pressure of not less than 0.6 MPa (6 bar, gauge pressure). During carriage, the liquid shall be under a layer of inert gas with a gauge pressure of not less than 20 kPa (0.2 bar).</p> <p>(2) Combination packagings<br/>Outer packagings:<br/>Drums (1A1, 1A2, 1B1, 1B2, 1N1, 1N2, 1H1, 1H2, 1D, 1G);<br/>Boxes (4A, 4B, 4N, 4C1, 4C2, 4D, 4F, 4G, 4H1, 4H2);<br/>Jerricans (3A1, 3A2, 3B1, 3B2, 3H1, 3H2).<br/>Inner packagings with a maximum net mass as follows:<br/>Glass 10 kg<br/>Metal or plastics 15 kg<br/>Each inner packaging shall be fitted with threaded closures.<br/>Each inner packaging shall be surrounded by inert cushioning and absorbent material in a quantity sufficient to absorb the entire contents.<br/>The maximum net mass per outer packaging shall not exceed 125 kg.</p> <p>(3) Steel drums (1A1) with a maximum capacity of 250 L.</p> <p>(4) Composite packagings consisting of plastics receptacle in a steel or aluminium drum (6HA1 or 6HB1) with a maximum capacity of 250 L.</p> |                     |      |
| <p><b>Special packing provision:</b><br/><b>PP31</b> For UN Nos. 1389, 1391, 1392, 1420, 1421, 1422, 3148, 3184 (PG II), 3185 (PG II), 3187 (PG II), 3188 (PG II), 3398 (PG I), 3399 (PG I) and 3482, packagings shall be hermetically sealed.</p>  |                     |      |



Chapter 4.1 – Use of packagings, including IBCs and large packagings

| P403  |  | PACKING INSTRUCTION  |                  | P403   |
|---|--|--|------------------|--------|
| The following packagings are authorized, provided that the general provisions of 4.1.1 and 4.1.3 are met.   |  |  |                  |        |
| Combination packagings  |  |  | Maximum net mass |        |
| Inner packagings  |  | Outer packagings   |                  |        |
| Glass   | 2 kg                                     | <b>Drums</b>   |                  |        |
| Plastic   | 15 kg                                    | steel (1A1, 1A2)   |                  | 400 kg |
| Metal   | 20 kg                                    | aluminium (1B1, 1B2)   |                  | 400 kg |
| Inner packagings shall be hermetically sealed (e.g. by taping or by threaded closures).   |  | other metal (1N1, 1N2)   |                  | 400 kg |
|   |  | plastics (1H1, 1H2)  |                  | 400 kg |
|   |  | plywood (1D)   |                  | 400 kg |
|   |  | fibre (1G)   |                  | 400 kg |
|   |  | <b>Boxes</b>   |                  |        |
|   |  | steel (4A)   |                  | 400 kg |
|   | aluminium (4B)                           |  | 400 kg           |        |
|   | other metal (4N)                         |  | 400 kg           |        |
|   | natural wood (4C1)                       |  | 250 kg           |        |
|   | natural wood with sift-proof walls (4C2) |  | 250 kg           |        |
|   | plywood (4D)                             |  | 250 kg           |        |
|   | reconstituted wood (4F)                  |  | 125 kg           |        |
|   | fibreboard (4G)                          |  | 125 kg           |        |
|   | expanded plastics (4H1)                  |  | 60 kg            |        |
|   | solid plastics (4H2)                     |  | 250 kg           |        |
|   |  | <b>Jerricans</b>   |                  |        |
|   |  | steel (3A1, 3A2)   |                  | 120 kg |
|   |  | aluminium (3B1, 3B2)   |                  | 120 kg |
|   |  | plastics (3H1, 3H2)  |                  | 120 kg |
| Single packagings   |  |  |                  |        |
| <b>Drums</b>  |  |  |                  |        |
|   |  | steel (1A1, 1A2)   |                  | 250 kg |
|   |  | aluminium (1B1, 1B2)   |                  | 250 kg |
|   |  | metal other than steel or aluminium (1N1, 1N2)   |                  | 250 kg |
|   |  | plastics (1H1, 1H2)  |                  | 250 kg |
| <b>Jerricans</b>  |  |  |                  |        |
|   |  | steel (3A1, 3A2)   |                  | 120 kg |
|   |  | aluminium (3B1, 3B2)   |                  | 120 kg |
|   |  | plastics (3H1, 3H2)  |                  | 120 kg |
| <b>Composite packagings</b>   |  |  |                  |        |
|   |  | Plastics receptacle in steel or aluminium drum (6HA1 or 6HB1)  |                  | 250 kg |
|   |  | Plastics receptacle in fibre, plastics or plywood drum (6HG1, 6HH1 or 6HD1)  |                  | 75 kg  |
|   |  | Plastics receptacle in steel, aluminium, wood, plywood, fibreboard or solid plastics box (6HA2, 6HB2, 6HC, 6HD2, 6HG2 or 6HH2) |                  | 75 kg  |
| <b>Pressure receptacles, provided that the general provisions of 4.1.3.6 are met</b>  |  |  |                  |        |
| <b>Special packing provisions:</b>  |  |  |                  |        |
| <b>PP31</b> For UN Nos. 1360, 1397, 1402, 1404, 1407, 1409, 1410, 1413, 1414, 1415, 1418, 1419, 1423, 1426, 1427, 1428, 1432, 1433, 1436, 1714, 1870, 2010, 2011, 2012, 2013, 2257, 2463, 2806, 2813, 3131, 3132, 3134, 3135, 3208, 3209, 3395, 3396, 3397, 3401, 3402, 3403 and 3404, packagings shall be hermetically sealed. |  |  |                  |        |
| <b>PP83 Deleted</b>   |  |  |                  |        |



Part 4 – Packing and tank provisions

| P404  | PACKING INSTRUCTION  | P404 |
|---|--|------|
| This instruction applies to pyrophoric solids: UN Nos. 1383, 1854, 1855, 2008, 2441, 2545, 2546, 2846, 2881, 3200, 3391 and 3393. |  |      |
| △   | <p>The following packagings are authorized, provided that the general provisions of 4.1.1 and 4.1.3 are met:</p> <p>(1) Combination packagings:<br/>Outer packagings:<br/>Drums (1A1, 1A2, 1B1, 1B2, 1N1, 1N2, 1H1, 1H2, 1D, 1G);<br/>Boxes (4A, 4B, 4N, 4C1, 4C2, 4D, 4F, 4G, 4H2).<br/>Inner packagings:<br/>Metal receptacles with a maximum net mass of 15 kg each. Inner packagings shall be hermetically sealed.<br/>Glass receptacles, with a maximum net mass of 1 kg each, having closures with gaskets, cushioned on all sides and contained in hermetically sealed metal cans.<br/>Outer packagings shall have a maximum net mass of 125 kg.<br/>Inner packagings shall have threaded closures or closures physically held in place by any means capable of preventing back-off or loosening of the closure by impact or vibration during transport.</p> <p>(2) Metal packagings:<br/>Drums (1A1, 1A2, 1B1, 1B2, 1N1, 1N2);<br/>Jerricans (3A1, 3A2, 3B1, 3B2).<br/>Maximum gross mass: 150 kg</p> <p>(3) Composite packagings:<br/>Plastics receptacle in a steel or aluminium drum (6HA1 or 6HB1)<br/>Maximum gross mass: 150 kg</p> <p>(4) Pressure receptacles, provided that the general provisions of 4.1.3.6 are met.</p> <p><b>Special packing provisions:</b><br/>PP31 For UN Nos. 1383, 1854, 1855, 2008, 2441, 2545, 2546, 2846, 2881 and 3200, packagings shall be hermetically sealed.<br/>PP86 For UN Nos. 3391 and 3393, air shall be eliminated from the vapour space by nitrogen or other means.</p> |      |

| P405                                 | PACKING INSTRUCTION   | P405 |
|--------------------------------------|---|------|
| This instruction applies to UN 1381. |   |      |
| △                                    | <p>The following packagings are authorized, provided that the general provisions of 4.1.1 and 4.1.3 are met:</p> <p>(1) For UN 1381, wet phosphorus:<br/>.1 Combination packagings<br/>Outer packagings:<br/>Boxes (4A, 4B, 4N, 4C1, 4C2, 4D or 4F); maximum net mass: 75 kg<br/>Inner packagings:<br/>(i) hermetically sealed metal cans, with a maximum net mass of 15 kg; or<br/>(ii) glass inner packagings cushioned on all sides with dry, absorbent, non-combustible material in a quantity sufficient to absorb the entire contents with a maximum net mass of 2 kg; or<br/>.2 Drums (1A1, 1A2, 1B1, 1B2, 1N1 or 1N2); maximum net mass: 400 kg<br/>Jerricans (3A1 or 3B1); maximum net mass: 120 kg.<br/>These packagings shall be capable of passing the leakproofness test specified in 6.1.5.4 at the packing group II performance level.</p> <p>(2) For UN 1381, dry phosphorus:<br/>.1 When fused, drums (1A2, 1B2 or 1N2) with a maximum net mass of 400 kg; or<br/>.2 In projectiles or hard-cased articles when transported without class 1 components, as specified by the competent authority.</p> <p><b>Special packing provision:</b><br/>PP31 For UN 1381, packagings shall be hermetically sealed.</p> |      |





Chapter 4.1 – Use of packagings, including IBCs and large packagings

| P406  | PACKING INSTRUCTION | P406 |
|---|---------------------|------|
| <p>The following packagings are authorized, provided that the general provisions of 4.1.1 and 4.1.3 are met:</p> <p>(1) Combination packagings<br/>Outer packagings: (4C1, 4C2, 4D, 4F, 4G, 4H1, 4H2, 1G, 1D, 1H1, 1H2, 3H1 or 3H2)<br/>Inner packagings shall be water-resistant.</p> <p>(2) Plastics, plywood or fibreboard drums (1H2, 1D or 1G) or boxes (4A, 4B, 4N, 4C1, 4D, 4F, 4C2, 4G and 4H2) with a water-resistant inner bag, plastics film lining or water-resistant coating.</p> <p>(3) Metal drums (1A1, 1A2, 1B1, 1B2, 1N1 or 1N2), plastics drums (1H1 or 1H2), metal jerricans (3A1, 3A2, 3B1 or 3B2), plastics jerricans (3H1 or 3H2), plastics receptacle in steel or aluminium drums (6HA1 or 6HB1), plastics receptacle in fibre, plastics or plywood drums (6HG1, 6HH1 or 6HD1), plastics receptacle in steel, aluminium, wood, plywood, fibreboard or solid plastics boxes (6HA2, 6HB2, 6HC, 6HD2, 6HG2 or 6HH2).</p>   |                     |      |
| <p><b>Additional provisions:</b></p> <p>1 Packagings shall be designed and constructed to prevent the loss of water or alcohol content or the content of the phlegmatizer.</p> <p>2 Packagings shall be so constructed and closed as to avoid an explosive overpressure or pressure build-up of more than 300 kPa (3 bar).</p> <p>3 The type of packaging and maximum permitted quantity per packaging are limited by the provisions of 2.1.3.4.</p>  |                     |      |
| <p><b>Special packing provisions:</b></p> <p><b>PP24</b> UN Nos. 2852, 3364, 3365, 3366, 3367, 3368 and 3369 shall not be transported in quantities of more than 500 g per package.</p> <p><b>PP25</b> UN 1347 shall not be transported in quantities of more than 15 kg per package.</p> <p><b>PP26</b> For UN Nos. 1310, 1320, 1321, 1322, 1344, 1347, 1348, 1349, 1517, 2907, 3317, 3344 and 3376, packagings shall be lead-free.</p> <p><b>PP31</b> For UN Nos. 1310, 1320, 1321, 1322, 1336, 1337, 1344, 1347, 1348, 1349, 1354, 1355, 1356, 1357, 1517, 1571, 2555, 2556, 2557, 2852, 3317, 3364, 3365, 3366, 3367, 3368, 3369, 3370 and 3376, packagings shall be hermetically sealed.</p> <p><b>PP48</b> For UN 3474, metal packagings shall not be used. Packagings of other material with a small amount of metal, for example metal closures or other metal fittings such as those mentioned in 6.1.4, are not considered metal packagings.</p> <p><b>PP78</b> UN 3370 shall not be transported in quantities of more than 11.5 kg per package.</p> <p><b>PP80</b> For UN Nos. 2907 and 3344, packagings shall meet the packing group II performance level. Packagings meeting the test criteria of packing group I shall not be used.</p> |                     |      |
| P407  | PACKING INSTRUCTION | P407 |
| <p>This instruction applies to UN Nos. 1331, 1944, 1945 and 2254.</p>   |                     |      |
| <p>The following packagings are authorized, provided that the general provisions of 4.1.1 and 4.1.3 are met:</p> <p>Outer packagings:<br/>Drums (1A1, 1A2, 1B1, 1B2, 1N1, 1N2, 1H1, 1H2, 1D, 1G);<br/>Boxes (4A, 4B, 4N, 4C1, 4C2, 4D, 4F, 4G, 4H1, 4H2);<br/>Jerricans (3A1, 3A2, 3B1, 3B2, 3H1, 3H2).</p> <p>Inner packagings:<br/>Matches shall be tightly packed in securely closed inner packagings to prevent accidental ignition under normal conditions of transport.</p> <p>The maximum gross mass of the package shall not exceed 45 kg except for fibreboard boxes which shall not exceed 30 kg.</p> <p>Packagings shall conform to the packing group III performance level.</p>   |                     |      |
| <p><b>Special packing provision:</b></p> <p><b>PP27</b> UN 1331, Strike-anywhere matches, shall not be packed in the same outer packaging with any other dangerous goods other than safety matches or wax Vesta matches, which shall be packed in separate inner packagings. Inner packagings shall not contain more than 700 strike-anywhere matches.</p>  |                     |      |



Part 4 – Packing and tank provisions

| P408  | PACKING INSTRUCTION | P408 |
|---|---------------------|------|
| This instruction applies to UN 3292.  |                     |      |
| <p>The following packagings are authorized, provided that the general provisions of 4.1.1 and 4.1.3 are met:</p> <p>(1) For cells:<br/>               Drums (1A2, 1B2, 1N2, 1H2, 1D, 1G);<br/>               Boxes (4A, 4B, 4N, 4C1, 4C2, 4D, 4F, 4G, 4H1, 4H2);<br/>               Jerricans (3A2, 3B2, 3H2).</p> <p>There shall be sufficient cushioning material to prevent contact between cells and between cells and the internal surfaces of the outer packaging and to ensure that no dangerous movement of the cells within the outer packaging occurs in transport.<br/> Packagings shall conform to the packing group II performance level.</p> <p>(2) Batteries may be transported unpacked or in protective enclosures (e.g. fully enclosed or wooden slatted crates). The terminals shall not support the weight of other batteries or materials packed with the batteries.<br/> Packagings need not meet the requirements of 4.1.1.3.</p> <p><b>Note:</b> The packagings authorized may exceed a net mass of 400 kg (see 4.1.3.3).</p> |                     |      |
| <b>Additional requirement:</b>  |                     |      |
| Cells and batteries shall be protected against short circuit and shall be isolated in such a manner as to prevent short circuits.   |                     |      |
| P409  | PACKING INSTRUCTION | P409 |
| This instruction applies to UN Nos. 2956, 3242 and 3251.  |                     |      |
| <p>The following packagings are authorized, provided that the general provisions of 4.1.1 and 4.1.3 are met:</p> <p>(1) Fibre drum (1G) which may be fitted with a liner or coating; maximum net mass: 50 kg.<br/> (2) Combination packagings: Fibreboard box (4G) with a single inner plastic bag; maximum net mass: 50 kg.<br/> (3) Combination packagings: Fibreboard box (4G) or fibre drum (1G) with inner plastic packagings each containing a maximum of 5 kg; maximum net mass: 25 kg.</p>  |                     |      |





Part 4 – Packing and tank provisions

| P410  | PACKING INSTRUCTION <i>(continued)</i> | P410 |
|---|--|------|
| <b>Special packing provisions:</b>  |  |      |
| <b>PP31</b> For UN Nos. 1326, 1339, 1340, 1341, 1343, 1352, 1358, 1373, 1374, 1378, 1379, 1382, 1384, 1385, 1390, 1393, 1394, 1395, 1396, 1398, 1400, 1401, 1402, 1405, 1409, 1417, 1418, 1431, 1436, 1437, 1871, 1923, 1929, 2004, 2008, 2318, 2545, 2546, 2624, 2805, 2813, 2830, 2835, 2844, 2881, 2940, 3078, 3088, 3131, 3132, 3134, 3135, 3170, 3182, 3189, 3190, 3205, 3206, 3208, 3209, 3395, 3396 and 3397, packagings shall be hermetically sealed. |  |      |
| <b>PP39</b> For UN 1378, for metal packagings a venting device is required.   |  |      |
| <b>PP40</b> For the following UN Nos., falling in PG II, bags are not allowed: 1326, 1340, 1352, 1358, 1374, 1378, 1382, 1390, 1393, 1394, 1395, 1396, 1400, 1401, 1402, 1405, 1409, 1417, 1418, 1436, 1437, 1871, 2624, 2805, 2813, 2830, 2835, 3078, 3131, 3132, 3134, 3170, 3182, 3208 and 3209.   |  |      |
| <b>PP83</b> Deleted   |  |      |
| <b>PP100</b> For UN 2950 flexible, fibreboard or wooden packagings shall be sift-proof and water-resistant or shall be fitted with a sift-proof and water-resistant liner.  |  |      |

| P411   | PACKING INSTRUCTION | P411 |
|--|---------------------|------|
| This instruction applies to UN 3270.   |                     |      |
| The following packagings are authorized, provided that the general provisions of 4.1.1 and 4.1.3 are met:<br>Drums (1A2, 1B2, 1N2, 1H2, 1D, 1G);<br>Boxes (4A, 4B, 4N, 4C1, 4C2, 4D, 4F, 4G, 4H1, 4H2);<br>Jerricans (3A2, 3B2, 3H2),<br>provided that explosion is not possible by reason of increased internal pressure.<br>The maximum net mass shall not exceed 30 kg. |                     |      |

| P412  | PACKING INSTRUCTION | P412 |
|---|---------------------|------|
| This instruction applies to UN No. 3527.  |                     |      |
| The following combination packagings are authorized, provided that the general provisions of 4.1.1 and 4.1.3 are met:<br>(1) Outer packagings:<br>Drums (1A1, 1A2, 1B1, 1B2, 1N1, 1N2, 1H1, 1H2, 1D, 1G);<br>Boxes (4A, 4B, 4N, 4C1, 4C2, 4D, 4F, 4G, 4H1, 4H2)<br>Jerricans (3A1, 3A2, 3B1, 3B2, 3H1, 3H2);<br>(2) Inner packagings:<br>(a) The activator (organic peroxide) shall have a maximum quantity of 125 ml per inner packaging if liquid, and 500 g per inner packaging if solid.<br>(b) The base material and the activator shall be each separately packed in inner packagings.<br>The components may be placed in the same outer packaging provided that they will not interact dangerously in the event of a leakage.<br>Packagings shall conform to the packing group II or III performance level according to the criteria for class 4.1 applied to the base material. |                     |      |

| P500   | PACKING INSTRUCTION | P500 |
|--|---------------------|------|
| This instruction applies to UN 3356.   |                     |      |
| The following packagings are authorized, provided that the general provisions of 4.1.1 and 4.1.3 are met:<br>Drums (1A2, 1B2, 1N2, 1H2, 1D, 1G);<br>Boxes (4A, 4B, 4N, 4C1, 4C2, 4D, 4F, 4G, 4H1, 4H2);<br>Jerricans (3A2, 3B2, 3H2).<br>Packagings shall conform to the packing group II performance level.<br>The generator(s) shall be transported in a package which meets the following requirements when one generator in the package is actuated:<br>(1) Other generators in the package will not be actuated;<br>(2) Packaging material will not ignite; and<br>(3) The outside surface temperature of the completed package shall not exceed 100°C. |                     |      |



Chapter 4.1 – Use of packagings, including IBCs and large packagings

| P501  | PACKING INSTRUCTION  |                                      | P501                                 |
|---|--|--------------------------------------|--------------------------------------|
| This instruction applies to UN 2015.  |  |                                      |                                      |
| The following packagings are authorized, provided that the general provisions of 4.1.1 and 4.1.3 are met.   |  |                                      |                                      |
|   | Combination packagings   | Inner packagings<br>maximum capacity | Outer packagings<br>maximum net mass |
| △   | Boxes (4A, 4B, 4N, 4C1, 4C2, 4D, 4H2) or drums (1A1, 1A2, 1B1, 1B2, 1N1, 1N2, 1H1, 1H2, 1D) or jerricans (3A1, 3A2, 3B1, 3B2, 3H1, 3H2) with glass, plastics or metal inner packagings | 5 L                                  | 125 kg                               |
| △   | Fibreboard box (4G) or fibre drum (1G), with plastics or metal inner packagings each in a plastics bag   | 2 L                                  | 50 kg                                |
| <b>Single packagings</b>  |  |                                      | <b>Maximum capacity</b>              |
| <b>Drums</b>  |  |                                      |                                      |
| steel (1A1)   |  |                                      | 250 L                                |
| aluminium (1B1)   |  |                                      | 250 L                                |
| metal other than steel or aluminium (1N1)   |  |                                      | 250 L                                |
| plastics (1H1)  |  |                                      | 250 L                                |
| <b>Jerricans</b>  |  |                                      |                                      |
| steel (3A1)   |  |                                      | 60 L                                 |
| aluminium (3B1)   |  |                                      | 60 L                                 |
| plastics (3H1)  |  |                                      | 60 L                                 |
| <b>Composite packagings</b>   |  |                                      |                                      |
| Plastics receptacle in steel or aluminium drum (6HA1, 6HB1)   |  |                                      | 250 L                                |
| Plastics receptacle in fibre, plastics or plywood drum (6HG1, 6HH1, 6HD1)   |  |                                      | 250 L                                |
| Plastics receptacle in steel or aluminium crate or box or plastics receptacle in wood, plywood, fibreboard or solid plastics box (6HA2, 6HB2, 6HC, 6HD2, 6HG2 or 6HH2)  |  |                                      | 60 L                                 |
| Glass receptacle in steel, aluminium, fibre or plywood drum (6PA1, 6PB1, 6PD1 or 6PG1) or in a steel, aluminium, wood or fibreboard box or in wickerwork hamper (6PA2, 6PB2, 6PC, 6PG2 or 6PD2) or in expanded or solid plastics packaging (6PH1 or 6PH2) |  |                                      | 60 L                                 |
| <b>Additional provisions:</b>   |  |                                      |                                      |
| 1 Packagings shall have a minimum ullage of 10%.  |  |                                      |                                      |
| 2 Packagings shall be vented.   |  |                                      |                                      |



Part 4 – Packing and tank provisions

| P502  |     | PACKING INSTRUCTION   |                  | P502                    |        |
|---|-----|---|------------------|-------------------------|--------|
| The following packagings are authorized, provided that the general provisions of 4.1.1 and 4.1.3 are met.   |     |   |                  |                         |        |
| Combination packagings  |     |   | Maximum net mass |                         |        |
| Inner packagings  |     | Outer packagings  |                  |                         |        |
| Glass   | 5 L | <b>Drums</b><br>steel (1A1, 1A2)<br>aluminium (1B1, 1B2)<br>other metal (1N1, 1N2)<br>plywood (1D)<br>fibre (1G)<br>plastics (1H1, 1H2)   |                  |                         |        |
| Metal   | 5 L |   |                  | 125 kg                  |        |
| Plastic   | 5 L |   |                  |                         | 125 kg |
|   |     |   |                  |                         | 125 kg |
|   |     |   |                  |                         | 125 kg |
|   |     |   |                  |                         | 125 kg |
|   |     | <b>Boxes</b><br>steel (4A)<br>aluminium (4B)<br>other metal (4N)<br>natural wood (4C1)<br>natural wood with sift-proof walls (4C2)<br>plywood (4D)<br>reconstituted wood (4F)<br>fibreboard (4G)<br>expanded plastics (4H1)<br>solid plastics (4H2) |                  |                         |        |
|   |     |   |                  | 125 kg                  |        |
|   |     |   |                  | 125 kg                  |        |
|   |     |   |                  | 125 kg                  |        |
|   |     |   |                  | 125 kg                  |        |
|   |     |   |                  | 125 kg                  |        |
|   |     |   |                  | 125 kg                  |        |
|   |     |   |                  | 125 kg                  |        |
|   |     |   |                  | 60 kg                   |        |
|   |     |   |                  | 125 kg                  |        |
| Single packagings   |     |   | Maximum capacity |                         |        |
| <b>Drums</b><br>steel (1A1)<br>aluminium (1B1)<br>plastics (1H1)  |     |   |                  | 250 L<br>250 L<br>250 L |        |
| <b>Jerricans</b><br>steel (3A1)<br>aluminium (3B1)<br>plastics (3H1)  |     |   |                  | 60 L<br>60 L<br>60 L    |        |
| Composite packagings  |     |   |                  |                         |        |
| Plastics receptacle in steel or aluminium drum (6HA1, 6HB1)   |     |   |                  | 250 L                   |        |
| Plastics receptacle in fibre, plastics or plywood drum (6HG1, 6HH1, 6HD1)   |     |   |                  | 250 L                   |        |
| Plastics receptacle in steel or aluminium crate or box or plastics receptacle in wood, plywood, fibreboard or solid plastics box (6HA2, 6HB2, 6HC, 6HD2, 6HG2 or 6HH2)  |     |   |                  | 60 L                    |        |
| Glass receptacle in steel, aluminium, fibre or plywood drum (6PA1, 6PB1, 6PD1 or 6PG1) or in a steel, aluminium, wood or fibreboard box or in wickerwork hamper (6PA2, 6PB2, 6PC, 6PG2 or 6PD2) or in expanded or solid plastics packaging (6PH1 or 6PH2) |     |   |                  | 60 L                    |        |
| <b>Special packing provision:</b><br>PP28 For UN No. 1873, parts of packagings which are in direct contact with perchloric acid shall be constructed of glass or plastics.  |     |   |                  |                         |        |



Chapter 4.1 – Use of packagings, including IBCs and large packagings

| P503  |      | PACKING INSTRUCTION   |                  | P503   |
|---|------|---|------------------|--------|
| The following packagings are authorized, provided that the general provisions of 4.1.1 and 4.1.3 are met.   |      |   |                  |        |
| Combination packagings  |      |   | Maximum net mass |        |
| Inner packagings  |      | Outer packagings  |                  |        |
| Glass   | 5 kg | <b>Drums</b><br>steel (1A1, 1A2)<br>aluminium (1B1, 1B2)<br>other metal (1N1, 1N2)<br>fibre (1G)<br>plywood (1D)<br>plastics (1H1, 1H2)   |                  |        |
| Metal   | 5 kg |   |                  | 125 kg |
| Plastic   | 5 kg |   |                  | 125 kg |
|   |      |   |                  | 125 kg |
|   |      |   |                  | 125 kg |
|   |      | <b>Boxes</b><br>steel (4A)<br>aluminium (4B)<br>other metal (4N)<br>natural wood (4C1)<br>natural wood with sift-proof walls (4C2)<br>plywood (4D)<br>reconstituted wood (4F)<br>fibreboard (4G)<br>expanded plastics (4H1)<br>solid plastics (4H2) |                  |        |
|   |      |   |                  | 125 kg |
|   |      |   |                  | 125 kg |
|   |      |   |                  | 125 kg |
|   |      |   |                  | 125 kg |
|   |      |   |                  | 125 kg |
|   |      |   |                  | 40 kg  |
|   |      |   |                  | 60 kg  |
|   |      |   | 125 kg           |        |
| Single packagings   |      |   | Maximum net mass |        |
| Metal drums (1A1, 1A2, 1B1, 1B2, 1N1 or 1N2)  |      |   |                  | 250 kg |
| Fibreboard (1G) or plywood drums (1D) fitted with inner liners  |      |   |                  | 200 kg |
| P504  |      | PACKING INSTRUCTION   |                  | P504   |
| The following packagings are authorized, provided that the general provisions of 4.1.1 and 4.1.3 are met.   |      |   |                  |        |
| Combination packagings  |      |   | Maximum net mass |        |
| (1) Outer packagings: (1A1, 1A2, 1B1, 1B2, 1N1, 1N2, 1H1, 1H2, 1D, 1G, 4A, 4B, 4N, 4C1, 4C2, 4D, 4F, 4G, 4H2)<br>Inner packagings: Glass receptacles with a maximum capacity of 5 L   |      |   | 75 kg            |        |
| (2) Outer packagings: (1A1, 1A2, 1B1, 1B2, 1N1, 1N2, 1H1, 1H2, 1D, 1G, 4A, 4B, 4N, 4C1, 4C2, 4D, 4F, 4G, 4H2)<br>Inner packagings: Plastics receptacles with a maximum capacity of 30 L   |      |   | 75 kg            |        |
| (3) Outer packagings: (1G, 4F or 4G)<br>Inner packagings: Metal receptacles with a maximum capacity of 40 L   |      |   | 125 kg           |        |
| (4) Outer packagings: (1A1, 1A2, 1B1, 1B2, 1N1, 1N2, 1H1, 1H2, 1D, 4A, 4B, 4N, 4C1, 4C2, 4D, 4H2)<br>Inner packagings: Metal receptacles with a maximum capacity of 40 L  |      |   | 225 kg           |        |
| Single packagings   |      |   | Maximum capacity |        |
| <b>Drums</b>  |      |   |                  |        |
| steel, non-removable head (1A1)   |      |   | 250 L            |        |
| aluminium, non-removable head (1B1)   |      |   | 250 L            |        |
| metal, other than steel or aluminium, non-removable head (1N1)  |      |   | 250 L            |        |
| plastics, non-removable head (1H1)  |      |   | 250 L            |        |
| <b>Jerricans</b>  |      |   |                  |        |
| steel, non-removable head (3A1)   |      |   | 60 L             |        |
| aluminium, non-removable head (3B1)   |      |   | 60 L             |        |
| plastics, non-removable head (3H1)  |      |   | 60 L             |        |
| <b>Composite packagings</b>   |      |   |                  |        |
| Plastics receptacle in steel or aluminium drum (6HA1, 6HB1)   |      |   | 250 L            |        |
| Plastics receptacle in fibre, plastics or plywood drum (6HG1, 6HH1, 6HD1)   |      |   | 120 L            |        |
| Plastics receptacle in steel or aluminium crate or box or plastics receptacle in wood, plywood, fibreboard or solid plastics box (6HA2, 6HB2, 6HC, 6HD2, 6HG2 or 6HH2)  |      |   | 60 L             |        |
| Glass receptacle in steel, aluminium, fibre or plywood drum (6PA1, 6PB1, 6PD1 or 6PG1) or in a steel, aluminium, wood or fibreboard box or in wickerwork hamper (6PA2, 6PB2, 6PC, 6PG2 or 6PD2) or in expanded or solid plastics packaging (6PH1 or 6PH2) |      |   | 60 L             |        |
| <b>Special packing provisions:</b>  |      |   |                  |        |
| PP10 For UN Nos. 2014 and 3149, the packaging shall be vented.  |      |   |                  |        |
| PP31 For UN 2626, packagings shall be hermetically sealed.  |      |   |                  |        |



Part 4 – Packing and tank provisions

| P505  |   | PACKING INSTRUCTION     |                                      | P505  |
|---|---|-------------------------|--------------------------------------|---|
| This instruction applies to UN 3375.  |   |                         |                                      |   |
| The following packagings are authorized, provided that the general provisions of 4.1.1 and 4.1.3 are met. |   |                         |                                      |   |
| △   | <b>Combination packagings</b>   |                         |                                      | <b>Maximum capacity/<br/>maximum net mass</b> |
| △   | <b>Inner packagings</b>   | <b>Outer packagings</b> |                                      |   |
| △   | Glass   | 5 L                     | <b>Boxes</b>                         |   |
|   | Plastics  | 5 L                     | aluminium (4B)                       | 125 kg  |
|   | Metal   | 5 L                     | natural wood, ordinary (4C1)         | 125 kg  |
|   |   |                         | natural wood, sift-proof walls (4C2) | 125 kg  |
|   |   |                         | plywood (4D)                         | 125 kg  |
|   |   |                         | fibreboard (4G)                      | 125 kg  |
|   |   |                         | plastics, solid (4H2)                | 125 kg  |
|   |   |                         | <b>Drums</b>                         |   |
|   |   |                         | aluminium, removable head (1B2)      | 125 kg  |
|   |   |                         | fibre (1G)                           | 125 kg  |
|   |   |                         | other metal, removable head (1N2)    | 125 kg  |
|   |   |                         | plastics, removable head (1H2)       | 125 kg  |
|   |   |                         | plywood (1D)                         | 125 kg  |
|   |   |                         | <b>Jerricans</b>                     |   |
|   |   |                         | aluminium, removable head (3B2)      | 125 kg  |
|   |   |                         | plastics, removable head (3H2)       | 125 kg  |
| △   | <b>Single packagings</b>  |                         |                                      |   |
|   | <b>Drums</b>  |                         |                                      |   |
|   | aluminium (1B1, 1B2)  |                         |                                      | 250 L   |
|   | plastics (1H1, 1H2)   |                         |                                      | 250 L   |
|   | <b>Jerricans</b>  |                         |                                      |   |
|   | aluminium (3B1, 3B2),<br>plastics (3H1, 3H2)  |                         |                                      | 60 L<br>60 L                                  |
|   | <b>Composite packagings</b>   |                         |                                      |   |
|   | plastics receptacle with outer aluminium drum (6HB1)  |                         |                                      | 250 L   |
|   | plastics receptacle with outer fibre, plastics or plywood drum<br>(6HG1, 6HH1, 6HD1)  |                         |                                      | 250 L   |
|   | plastics receptacle with outer aluminium crate or box or plastics receptacle with<br>outer wooden, plywood, fibreboard or solid plastics box (6HB2, 6HC, 6HD2, 6HG2,<br>6HH2)   |                         |                                      | 60 L  |
|   | glass receptacle with outer aluminium, fibre or plywood drum (6PB1, 6PG1, 6PD1)<br>or with outer expanded plastics or solid plastics receptacles (6PH1, 6PH2) or with<br>outer aluminium crate or box or with outer wooden or fibreboard box or with outer<br>wickerwork hamper (6PB2, 6PC, 6PG2, 6PD2) |                         |                                      | 60 L  |



Chapter 4.1 – Use of packagings, including IBCs and large packagings

| P520   | PACKING INSTRUCTION  |     |                  |     |                  |     |     |     | P520             |
|--|--|-----|------------------|-----|------------------|-----|-----|-----|------------------|
| This instruction applies to organic peroxides of class 5.2 and self-reactive substances of class 4.1.  |  |     |                  |     |                  |     |     |     |                  |
| <p>The packagings listed below are authorized provided the general provisions of 4.1.1 and 4.1.3 and special provisions of 4.1.7 are met.</p> <p>The packing methods are designated OP1 to OP8. The packing methods appropriate for the individual currently assigned organic peroxides and self-reactive substances are listed in 2.4.2.3.2.3 and 2.5.3.2.4. The quantities specified for each packing method are the maximum quantities authorized per package. The following packagings are authorized:</p>   |  |     |                  |     |                  |     |     |     |                  |
| △  | <p>(1) Combination packagings with outer packagings comprising boxes (4A, 4B, 4N, 4C1, 4C2, 4D, 4F, 4G, 4H1 and 4H2), drums (1A1, 1A2, 1B1, 1B2, 1G, 1H1, 1H2 and 1D) and jerricans (3A1, 3A2, 3B1, 3B2, 3H1 and 3H2);</p> <p>(2) Single packagings consisting of drums (1A1, 1A2, 1B1, 1B2, 1G, 1H1, 1H2 and 1D) and jerricans (3A1, 3A2, 3B1, 3B2, 3H1 and 3H2);</p> <p>(3) Composite packagings with plastics inner receptacles (6HA1, 6HA2, 6HB1, 6HB2, 6HC, 6HD1, 6HD2, 6HG1, 6HG2, 6HH1 and 6HH2).</p> |     |                  |     |                  |     |     |     |                  |
| △  | <b>The maximum quantities per packaging/package for packing methods OP1 to OP8 are:</b>  |     |                  |     |                  |     |     |     |                  |
| △  |  | OP1 | OP2 <sup>1</sup> | OP3 | OP4 <sup>1</sup> | OP5 | OP6 | OP7 | OP8              |
| △  | Maximum net mass (kg) for solids and for combination packagings (liquid and solid)   | 0.5 | 0.5/10           | 5   | 5/25             | 25  | 50  | 50  | 400 <sup>2</sup> |
|  | Maximum contents in litres for liquids <sup>3</sup>  | 0.5 | –                | 5   | –                | 30  | 60  | 60  | 225 <sup>4</sup> |
| <p><sup>1</sup> If two values are given, the first applies to the maximum net mass per inner packaging and the second to the maximum net mass of the complete package.</p> <p><sup>2</sup> 60 kg for jerricans/200 kg for boxes and, for solids, 400 kg in combination packagings with outer packagings comprising boxes (4C1, 4C2, 4D, 4F, 4G, 4H1 and 4H2) and with inner packagings of plastics or fibre with a maximum net mass of 25 kg.</p> <p><sup>3</sup> Viscous liquids shall be treated as solids when they do not meet the criteria provided in the definition for liquids presented in 1.2.1.</p> <p><sup>4</sup> 60 L for jerricans.</p>                                   |  |     |                  |     |                  |     |     |     |                  |
| <b>Additional provisions:</b>  |  |     |                  |     |                  |     |     |     |                  |
| <p>1 Metal packagings, including inner packagings of combination packagings and outer packagings of combination or composite packagings, may only be used for packing methods OP7 and OP8.</p> <p>2 In combination packagings, glass receptacles may only be used as inner packagings with a maximum content of 0.5 kg for solids or 0.5 L for liquids.</p> <p>3 In combination packagings, cushioning materials shall not be readily combustible.</p> <p>4 The packaging of an organic peroxide or self-reactive substance required to bear an EXPLOSIVE subsidiary hazard label (Model No. 1, see 5.2.2.2.2) shall also comply with the provisions given in 4.1.5.10 and 4.1.5.11.</p> |  |     |                  |     |                  |     |     |     |                  |



Part 4 – Packing and tank provisions

| P520                               | PACKING INSTRUCTION (continued)   | P520 |
|------------------------------------|---|------|
| <i>Special packing provisions:</i> |   |      |
| <b>PP21</b>                        | For certain self-reactive substances of types B or C, UN Nos. 3221, 3222, 3223, 3224, 3231, 3232, 3233 and 3234, a smaller packaging than that allowed by packing methods OP5 or OP6 respectively shall be used (see 4.1.7 and 2.4.2.3.2.3).  |      |
| <b>PP22</b>                        | UN 3241, 2-bromo-2-nitropropane-1,3-diol, shall be packed in accordance with packing method OP6.  |      |
| <b>PP94</b>                        | Very small amounts of energetic samples of section 2.0.4.3 may be carried under UN 3223 or UN 3224, as appropriate, provided that: <ol style="list-style-type: none"> <li>.1 only combination packaging with outer packaging comprising boxes (4A, 4B, 4N, 4C1, 4C2, 4D, 4F, 4G, 4H1 and 4H2) are used;</li> <li>.2 the samples are carried in microtiter plates or multi-titer plates made of plastics, glass, porcelain or stoneware as inner packaging;</li> <li>.3 the maximum amount per individual inner cavity does not exceed 0.01 g for solids or 0.01 mL for liquids;</li> <li>.4 the maximum net quantity per outer packaging is 20 g for solids or 20 mL for liquids, or in the case of mixed packing the sum of grams and millilitres does not exceed 20; and</li> <li>.5 when dry ice or liquid nitrogen is optionally used as a coolant for quality control measures, the requirements of 5.5.3 are complied with. Interior supports shall be provided to secure the inner packagings in their original position. The inner and outer packagings shall maintain their integrity at the temperature of the refrigerant used as well as the temperatures and the pressures which could result if refrigeration were lost.</li> </ol>   |      |
| <b>PP95</b>                        | Small amounts of energetic samples of section 2.0.4.3 may be carried under UN 3223 or UN 3224, as appropriate, provided that: <ol style="list-style-type: none"> <li>.1 the outer packaging consist only of corrugated fibreboard of type 4G having minimum dimensions of 60 cm (length) by 40.5 cm (width) by 30 cm (height) and minimum wall thickness of 1.3 cm;</li> <li>.2 the individual substance is contained in an inner packaging of glass or plastics of maximum capacity 30 mL placed in an expandable polyethylene foam matrix of at least 130 mm thickness having a density of <math>18 \pm 1</math> g/L;</li> <li>.3 within the foam carrier, inner packagings are segregated from each other by a minimum distance of 40 mm and from the wall of the outer packaging by a minimum distance of 70 mm. The package may contain up to two layers of such foam matrices, each carrying up to 28 inner packagings;</li> <li>.4 the maximum content of each inner packaging does not exceed 1 g for solids or 1 mL for liquids;</li> <li>.5 the maximum net quantity per outer packaging is 56 g for solids or 56 mL for liquids, or in the case of mixed packing the sum of grams and millilitres does not exceed 56; and</li> <li>.6 when dry ice or liquid nitrogen is optionally used as a coolant for quality control measures, the requirements of 5.5.3 are complied with. Interior supports shall be provided to secure the inner packagings in their original position. The inner and outer packagings shall maintain their integrity at the temperature of the refrigerant used as well as the temperatures and the pressures which could result if refrigeration were lost.</li> </ol> |      |

| P600   | PACKING INSTRUCTION  | P600 |
|--|--|------|
| This instruction applies to UN Nos. 1700, 2016 and 2017. |  |      |
| △  | <p>The following packagings are authorized, provided that the general provisions of 4.1.1 and 4.1.3 are met:<br/>           Drums (1A1, 1A2, 1B1, 1B2, 1N1, 1N2, 1H1, 1H2, 1D, 1G);<br/>           Boxes (4A, 4B, 4N, 4C1, 4C2, 4D, 4F, 4G, 4H2).</p> <p>Outer packagings shall meet the packing group II performance level.</p> <p>Articles shall be individually packaged and separated from each other using partitions, dividers, inner packagings or cushioning material to prevent inadvertent discharge during normal conditions of transport.</p> <p>Maximum net mass: 75 kg</p> |      |



Chapter 4.1 – Use of packagings, including IBCs and large packagings

| P601  | PACKING INSTRUCTION | P601 |
|---|---------------------|------|
| <p>The following packagings are authorized provided the general provisions of 4.1.1 and 4.1.3 are met and the packagings are hermetically sealed:</p> <p>(1) Combination packagings with a maximum gross mass of 15 kg, consisting of:</p> <ul style="list-style-type: none"> <li>(a) one or more glass inner packaging(s) with a maximum net quantity of 1 L each and filled to not more than 90% of their capacity; the closure(s) of which shall be physically held in place by any means capable of preventing back-off or loosening by impact or vibration during transport, individually placed in</li> <li>(b) metal receptacles together with cushioning and absorbent material sufficient to absorb the entire contents of the glass inner packaging(s), further packed in</li> <li>(c) 1A1, 1A2, 1B1, 1B2, 1N1, 1N2, 1H1, 1H2, 1D, 1G, 4A, 4B, 4N, 4C1, 4C2, 4D, 4F, 4G or 4H2 outer packagings.</li> </ul> <p>(2) Combination packagings consisting of metal or plastics inner packagings not exceeding 5 L in capacity individually packed with absorbent material sufficient to absorb the contents and inert cushioning material in 1A1, 1A2, 1B1, 1B2, 1N1, 1N2, 1H1, 1H2, 1D, 1G, 4A, 4B, 4N, 4C1, 4C2, 4D, 4F, 4G or 4H2 outer packagings with a maximum gross mass of 75 kg. Inner packagings shall not be filled to more than 90% of their capacity. The closure of each inner packaging shall be physically held in place by any means capable of preventing back-off or loosening of the closure by impact or vibration during transport.</p> <p>(3) Packagings consisting of:</p> <p>Outer packagings: Steel or plastics drums, (1A1, 1A2, 1H1 or 1H2), tested in accordance with the test provisions in 6.1.5 at a mass corresponding to the mass of the assembled package either as a packaging intended to contain inner packagings, or as a single packaging intended to contain solids or liquids, and marked accordingly.</p> <p>Inner packagings: Drums and composite packagings (1A1, 1B1, 1N1, 1H1 or 6HA1), meeting the provisions of chapter 6.1 for single packagings, subject to the following conditions:</p> <ul style="list-style-type: none"> <li>.1 the hydraulic pressure test shall be conducted at a pressure of at least 3 bar (gauge pressure);</li> <li>.2 the design and production leakproofness tests shall be conducted at a test pressure of 0.30 bar;</li> <li>.3 they shall be isolated from the outer drum by the use of inert shock-mitigating cushioning material which surrounds the inner packaging on all sides;</li> <li>.4 their capacity shall not exceed 125 L;</li> <li>.5 closures shall be of a screw-cap type that are: <ul style="list-style-type: none"> <li>(i) physically held in place by any means capable of preventing back-off or loosening of the closure by impact or vibration during transport; and</li> <li>(ii) provided with a cap seal.</li> </ul> </li> <li>.6 The outer and inner packagings shall be subjected periodically to a leakproofness test according to .2 at intervals of not more than two and a half years; and</li> <li>.7 The outer and inner packagings shall bear in clearly legible and durable characters: <ul style="list-style-type: none"> <li>(i) the date (month, year) of the initial testing and the latest periodic test;</li> <li>(ii) the name or authorized symbol of the party performing the tests and inspections.</li> </ul> </li> </ul> <p>(4) Pressure receptacles, provided that the general provisions of 4.1.3.6 are met. They shall be subjected to an initial test and periodic tests every 10 years at a pressure of not less than 1 MPa (10 bar) (gauge pressure). Pressure receptacles may not be equipped with any pressure relief device. Each pressure receptacle containing a toxic by inhalation liquid with an LC<sub>50</sub> less than or equal to 200 mL/m<sup>3</sup> (ppm) shall be closed with a plug or valve conforming to the following:</p> <ul style="list-style-type: none"> <li>(a) Each plug or valve shall have a taper-threaded connection directly to the pressure receptacle and be capable of withstanding the test pressure of the pressure receptacle without damage or leakage;</li> <li>(b) Each valve shall be of the packless type with non-perforated diaphragm, except that, for corrosive materials, a valve may be of the packed type with an assembly made gas-tight by means of a seal cap with gasket joint attached to the valve body or the pressure receptacle to prevent loss of material through or past the packing;</li> <li>(c) Each valve outlet shall be sealed by a threaded cap or threaded solid plug and inert gasket material;</li> <li>(d) The materials of construction for the pressure receptacle, valves, plugs, outlet caps, luting and gaskets shall be compatible with each other and with the lading.</li> </ul> <p>Each pressure receptacle with a wall thickness at any point of less than 2.0 mm and each pressure receptacle that does not have fitted valve protection shall be transported in an outer packaging. Pressure receptacles shall not be manifolded or interconnected.</p> |                     |      |



Part 4 – Packing and tank provisions

| P602   | PACKING INSTRUCTION | P602 |
|--|---------------------|------|
| <p>The following packagings are authorized, provided the general provisions of 4.1.1 and 4.1.3 are met and the packagings are hermetically sealed:</p> <p>(1) Combination packagings with a maximum gross mass of 15 kg, consisting of:</p> <ul style="list-style-type: none"> <li>(a) one or more glass inner packaging(s) with a maximum net quantity of 1 L each and filled to not more than 90% of their capacity, the closure(s) of which shall be physically held in place by any means capable of preventing back-off or loosening by impact or vibration during transport, individually placed in</li> <li>(b) metal receptacles together with cushioning and absorbent material sufficient to absorb the entire contents of the glass inner packaging(s), further packed in</li> <li>(c) 1A1, 1A2, 1B1, 1B2, 1N1, 1N2, 1H1, 1H2, 1D, 1G, 4A, 4B, 4N, 4C1, 4C2, 4D, 4F, 4G or 4H2 outer packagings.</li> </ul> <p>(2) Combination packagings consisting of metal or plastics inner packagings individually packed with absorbent material sufficient to absorb the contents and inert cushioning material in 1A1, 1A2, 1B1, 1B2, 1N1, 1N2, 1H1, 1H2, 1D, 1G, 4A, 4B, 4N, 4C1, 4C2, 4D, 4F, 4G or 4H2 outer packagings with a maximum gross mass of 75 kg. Inner packagings shall not be filled to more than 90% of their capacity. The closure of each inner packaging shall be physically held in place by any means capable of preventing back-off or loosening of the closure by impact or vibration during transport. Inner packagings shall not exceed 5 L in capacity.</p> <p>(3) Drums and composite packagings (1A1, 1B1, 1N1, 1H1, 6HA1 or 6HH1), subject to the following conditions:</p> <ul style="list-style-type: none"> <li>.1 the hydraulic pressure test shall be conducted at a pressure of at least 3 bar (gauge pressure);</li> <li>.2 the design and production leakproofness tests shall be conducted at a test pressure of 0.30 bar; and</li> <li>.3 closures shall be of a screw-cap type that are: <ul style="list-style-type: none"> <li>(i) physically held in place by any means capable of preventing back-off or loosening of the closure by impact or vibration during transport; and</li> <li>(ii) provided with a cap seal.</li> </ul> </li> </ul> <p>(4) Pressure receptacles, provided that the general provisions of 4.1.3.6 are met. They shall be subjected to an initial test and periodic tests every 10 years at a pressure of not less than 1 MPa (10 bar) (gauge pressure). Pressure receptacles may not be equipped with any pressure relief device. Each pressure receptacle containing a toxic by inhalation liquid with an LC<sub>50</sub> less than or equal to 200 mL/m<sup>3</sup> (ppm) shall be closed with a plug or valve conforming to the following:</p> <ul style="list-style-type: none"> <li>(a) Each plug or valve shall have a taper-threaded connection directly to the pressure receptacle and be capable of withstanding the test pressure of the pressure receptacle without damage or leakage;</li> <li>(b) Each valve shall be of the packless type with non-perforated diaphragm, except that, for corrosive materials, a valve may be of the packed type with an assembly made gas-tight by means of a seal cap with gasket joint attached to the valve body or the pressure receptacle to prevent loss of material through or past the packing;</li> <li>(c) Each valve outlet shall be sealed by a threaded cap or threaded solid plug and inert gasket material;</li> <li>(d) The materials of construction for the pressure receptacle, valves, plugs, outlet caps, luting and gaskets shall be compatible with each other and with the lading.</li> </ul> <p>Each pressure receptacle with a wall thickness at any point of less than 2.0 mm and each pressure receptacle that does not have fitted valve protection shall be transported in an outer packaging. Pressure receptacles shall not be manifolded or interconnected.</p> |                     |      |

| P603   | PACKING INSTRUCTION | P603 |
|--|---------------------|------|
| <p>This instruction applies to UN 3507.</p>  |                     |      |
| <p>The following packagings are authorized provided that the general provisions of 4.1.1 and 4.1.3 and the special packing provisions of 4.1.9.1.2, 4.1.9.1.4 and 4.1.9.1.7 are met:</p> <p>Packagings consisting of:</p> <ul style="list-style-type: none"> <li>(a) Metal or plastics primary receptacle(s); in</li> <li>(b) Leakproof rigid secondary packaging(s); in</li> <li>(c) A rigid outer packaging: <ul style="list-style-type: none"> <li>Drums (1A2, 1B2, 1N2, 1H2, 1D, 1G);</li> <li>Boxes (4A, 4B, 4C1, 4C2, 4D, 4F, 4G, 4H1, 4H2);</li> <li>Jerricans (3A2, 3B2, 3H2).</li> </ul> </li> </ul>  |                     |      |
| <p><b>Additional requirements:</b></p> <ul style="list-style-type: none"> <li>1 Primary inner receptacles shall be packed in secondary packagings in a way that, under normal conditions of transport, they cannot break, be punctured or leak their contents into the secondary packaging. Secondary packagings shall be secured in outer packagings with suitable cushioning material to prevent movement. If multiple primary receptacles are placed in a single secondary packaging, they shall be either individually wrapped or separated so as to prevent contact between them.</li> <li>2 The contents shall comply with the provisions of 2.7.2.4.5.2.</li> <li>3 The provisions of 6.4.4 shall be met.</li> <li>4 In the case of fissile-excepted material, limits specified in 2.7.2.3.5 shall be met.</li> </ul> |                     |      |
| <p>△</p> <p>⊗</p>  |                     |      |



Chapter 4.1 – Use of packagings, including IBCs and large packagings

| P620  | PACKING INSTRUCTION | P620   |
|---|---------------------|--|
| This instruction applies to UN Nos. 2814 and 2900.  |                     |  |
| <p>The following packagings are authorized, provided the special packing provisions of 4.1.8 are met:<br/>Packagings meeting the provisions of chapter 6.3 and approved accordingly consisting of:</p> <p>.1 Inner packagings comprising:</p> <ul style="list-style-type: none"> <li>(i) leakproof primary receptacle(s);</li> <li>(ii) a leakproof secondary packaging;</li> <li>(iii) other than for solid infectious substances, an absorbent material in sufficient quantity to absorb the entire contents placed between the primary receptacle(s) and the secondary packaging; if multiple primary receptacles are placed in a single secondary packaging, they shall be either individually wrapped or separated so as to prevent contact between them;</li> </ul> <p>.2 A rigid outer packaging:</p> <p>Drums (1A1, 1A2, 1B1, 1B2, 1N1, 1N2, 1H1, 1H2, 1D, 1G);<br/>Boxes (4A, 4B, 4N, 4C1, 4C2, 4D, 4F, 4G, 4H1, 4H2);<br/>Jerricans (3A1, 3A2, 3B1, 3B2, 3H1, 3H2).</p> <p>The smallest external dimension shall be not less than 100 mm.</p> |                     |  |
| <b>Additional provisions:</b>   |                     |  |
| △   | 1                   | Inner packagings containing infectious substances shall not be consolidated with inner packagings containing unrelated types of goods. Complete packages may be overpacked in accordance with the provisions of 1.2.1 and 5.1.2: such an overpack may contain dry ice. When dry ice or other refrigerants presenting a risk of asphyxiation are used as a coolant, the requirements of 5.5.3 shall apply.  |
|   | 2                   | Other than for exceptional consignments, such as whole organs which require special packaging, the following additional provisions shall apply:  |
|   | (a)                 | <i>Substances consigned at ambient temperatures or at a higher temperature.</i> Primary receptacles shall be of glass, metal or plastics. Positive means of ensuring a leakproof seal shall be provided, e.g. a heat seal, a skirted stopper or a metal crimp seal. If screw caps are used, they shall be secured by positive means, e.g. tape, paraffin sealing tape or a manufactured locking closure;   |
| △   | (b)                 | <i>Substances consigned refrigerated or frozen.</i> Ice, dry ice or other refrigerant shall be placed around the secondary packaging(s) or alternatively in an overpack with one or more complete packages marked in accordance with 6.3.3. Interior supports shall be provided to secure secondary packaging(s) or packages in position after the ice or dry ice has dissipated. When dry ice or other refrigerants presenting a risk of asphyxiation are used as a coolant, the requirements of 5.5.3 shall apply. If ice is used, the outer packaging or overpack shall be leakproof. If dry ice is used, the outer packaging or overpack shall permit the release of carbon dioxide gas. The primary receptacle and the secondary packaging shall maintain their integrity at the temperature of the refrigerant used; |
| △   | (c)                 | <i>Substances consigned in liquid nitrogen.</i> When liquid nitrogen is used as a coolant, the requirements of 5.5.3 shall apply. Plastics primary receptacles capable of withstanding very low temperature shall be used. The secondary packaging shall also be capable of withstanding very low temperatures, and in most cases will need to be fitted over the primary receptacle individually. Provisions for the consignment of liquid nitrogen shall also be fulfilled. The primary receptacle and the secondary packaging shall maintain their integrity at the temperature of the liquid nitrogen.   |
|   | (d)                 | Lyophilized substances may also be transported in primary receptacles that are flame-sealed glass ampoules or rubber-stoppered glass vials fitted with metal seals.  |
|   | 3                   | Whatever the intended temperature of the consignment, the primary receptacle or the secondary packaging shall be capable of withstanding, without leakage, an internal pressure producing a pressure differential of not less than 95 kPa. This primary receptacle or secondary packaging shall also be capable of withstanding temperatures in the range –40°C to +55°C.  |
|   | 4                   | Other dangerous goods shall not be packed in the same packaging as class 6.2 infectious substances unless they are necessary for maintaining the viability, stabilizing or preventing degradation or neutralizing the hazards of the infectious substances. A quantity of 30 mL or less of dangerous goods included in classes 3, 8 or 9 may be packed in each primary receptacle containing infectious substances. These small quantities of dangerous goods of classes 3, 8 or 9 are not subject to any additional provisions of this Code when packed in accordance with this packing instruction.  |
|   | 5                   | Alternative packagings for the transport of animal material may be authorized by the competent authority in accordance with the provisions of 4.1.3.7.   |

Part 4 – Packing and tank provisions

| P621   | PACKING INSTRUCTION | P621 |
|--|---------------------|------|
| This instruction applies to UN 3291.   |                     |      |
| The following packagings are authorized provided that the general provisions of 4.1.1 except 4.1.1.15 and 4.1.3 are met:   |                     |      |
| (1) Provided that there is sufficient absorbent material to absorb the entire amount of liquid present and the packaging is capable of retaining liquids:  |                     |      |
| <ul style="list-style-type: none"> <li>Drums (1A1, 1A2, 1B1, 1B2, 1N1, 1N2, 1H1, 1H2, 1D, 1G);</li> <li>Boxes (4A, 4B, 4N, 4C1, 4C2, 4D, 4F, 4G, 4H1, 4H2);</li> <li>Jerricans (3A1, 3A2, 3B1, 3B2, 3H1, 3H2).</li> </ul>  |                     |      |
| Packagings shall conform to the packing group II performance level for solids.   |                     |      |
| (2) For packages containing larger quantities of liquid:   |                     |      |
| <ul style="list-style-type: none"> <li>Drums (1A1, 1A2, 1B1, 1B2, 1N1, 1N2, 1H1, 1H2, 1D, 1G);</li> <li>Jerricans (3A1, 3A2, 3B1, 3B2, 3H1, 3H2);</li> <li>Composite packagings (6HA1, 6HB1, 6HG1, 6HH1, 6HD1, 6HA2, 6HB2, 6HC, 6HD2, 6HG2, 6HH2, 6PA1, 6PB1, 6PG1, 6PD1, 6PH1, 6PH2, 6PA2, 6PB2, 6PC, 6PG2 or 6PD2).</li> </ul> |                     |      |
| Packagings shall conform to the packing group II performance level for liquids.  |                     |      |
| <b>Additional requirement:</b>   |                     |      |
| Packagings intended to contain sharp objects such as broken glass and needles shall be resistant to puncture and retain liquids under the performance test conditions in Chapter 6.1.  |                     |      |

| P622  | PACKING INSTRUCTION            | P622  |
|---|--------------------------------|---|
| This instruction applies to waste of UN 3549 transported for disposal.  |                                |   |
| The following large packagings are authorized provided the general provisions of 4.1.1 and 4.1.3 are met:   |                                |   |
| <b>Inner packagings</b>   | <b>Intermediate packagings</b> | <b>Outer packagings</b>   |
| metal<br>plastics   | metal<br>plastics              | <b>Boxes</b><br>steel (4A)<br>aluminium (4B)<br>plywood (4D)<br>fibreboard (4G)<br>other metal (4N)<br>plastics, solid (4H2)<br><br><b>Drums</b><br>steel (1A2)<br>aluminium (1B2)<br>plywood (1D)<br>fibre (1G)<br>other metal (1N2)<br>plastics (1H2)<br><br><b>Jerricans</b><br>steel (3A2)<br>aluminium (3B2)<br>plastics (3H2) |
| The outer packaging shall conform to the packing group I performance level for solids.  |                                |   |
| <b>Additional requirements:</b>   |                                |   |
| <ol style="list-style-type: none"> <li>1. Fragile articles shall be contained in either a rigid inner packaging or a rigid intermediate packaging.</li> <li>2. Inner packagings containing sharp objects such as broken glass and needles shall be rigid and resistant to puncture.</li> <li>3. The inner packaging, the intermediate packaging and the outer packaging shall be capable of retaining liquids. Outer packagings that are not capable of retaining liquids by design shall be fitted with a liner or suitable measure of retaining liquids.</li> <li>4. The inner packaging and/or the intermediate packaging may be flexible. When flexible packagings are used, they shall be capable of passing the impact resistance test of at least 165 g according to ISO 7765-1:1988 <i>Plastics film and sheeting – Determination of impact resistance by the free-falling dart method – Part 1: Staircase methods</i> and the tear resistance test of at least 480 g in both parallel and perpendicular planes with respect to the length of the bag in accordance with ISO 6383-2:1983 <i>Plastics – Film and sheeting – Determination of tear resistance – Part 2: Elmendorf method</i>. The maximum net mass of each flexible inner packaging shall be 30 kg.</li> <li>5. Each flexible intermediate packaging shall contain only one inner packaging.</li> <li>6. Inner packagings containing a small amount of free liquid may be included in intermediate packaging provided that there is sufficient absorbent or solidifying material in the inner or intermediate packaging to absorb or solidify all the liquid content present. Suitable absorbent material which may withstand the temperatures and vibrations liable to occur under normal conditions of transport shall be used.</li> <li>7. Intermediate packagings shall be secured in outer packagings with suitable cushioning and/or absorbent material.</li> </ol> |                                |   |



Chapter 4.1 – Use of packagings, including IBCs and large packagings

| P650                                 | PACKING INSTRUCTION  | P650 |
|--------------------------------------|--|------|
| This instruction applies to UN 3373. |  |      |
|                                      | <p>(1) The packaging shall be of good quality, strong enough to withstand the shocks and loadings normally encountered during transport, including transshipment between cargo transport units and between cargo transport units and warehouses as well as any removal from a pallet or overpack for subsequent manual or mechanical handling. Packagings shall be constructed and closed to prevent any loss of contents that might be caused under normal conditions of transport by vibration or by changes in temperature, humidity or pressure.</p> <p>(2) The packaging shall consist of at least three components:</p> <ul style="list-style-type: none"> <li>(a) a primary receptacle;</li> <li>(b) a secondary packaging; and</li> <li>(c) an outer packaging</li> </ul> <p>of which either the secondary or the outer packaging shall be rigid.</p> <p>(3) Primary receptacles shall be packed in secondary packagings in such a way that, under normal conditions of transport, they cannot break, be punctured or leak their contents into the secondary packaging. Secondary packagings shall be secured in outer packagings with suitable cushioning material. Any leakage of the contents shall not compromise the integrity of the cushioning material or of the outer packaging.</p> <p>(4) For transport, the mark illustrated below shall be displayed on the external surface of the outer packaging on a background of a contrasting colour and shall be clearly visible and legible. The mark shall be in the form of a square set at an angle of 45° (diamond-shaped) with each side having a length of at least 50 mm, the width of the line shall be at least 2 mm and the letters and numbers shall be at least 6 mm high. The proper shipping name "BIOLOGICAL SUBSTANCE, CATEGORY B" in letters at least 6 mm high shall be marked on the outer packaging adjacent to the diamond-shaped mark.</p> |      |
|                                      |   |      |
|                                      | <p>(5) At least one surface of the outer packaging shall have a minimum dimension of 100 mm × 100 mm.</p>  |      |
| △                                    | <p>(6) The completed package shall be capable of withstanding a 1.2 m drop in any orientation without leakage from the primary receptacle(s), which shall remain protected by absorbent material, when required, in the secondary packaging.</p> <p><b>Note:</b> Capability may be demonstrated by testing, assessment or experience.</p>  |      |
|                                      | <p>(7) For liquid substances</p> <ul style="list-style-type: none"> <li>(a) The primary receptacle(s) shall be leakproof;</li> <li>(b) The secondary packaging shall be leakproof;</li> <li>(c) If multiple fragile primary receptacles are placed in a single secondary packaging, they shall either be individually wrapped or separated to prevent contact between them;</li> </ul>   |      |
| △                                    | <p>(d) Absorbent material shall be placed between the primary receptacle(s) and the secondary packaging. The absorbent material shall be in a quantity sufficient to absorb the entire contents of the primary receptacle(s) so that any release of the liquid substance will not compromise the integrity of the cushioning material or of the outer packaging; and</p>   |      |
|                                      | <p>(e) The primary receptacle or the secondary packaging shall be capable of withstanding, without leakage, an internal pressure of 95 kPa (0.95 bar).</p>   |      |
| △                                    | <p><b>Note:</b> Capability may be demonstrated by testing, assessment or experience.</p>   |      |
|                                      | <p>(8) For solid substances</p> <ul style="list-style-type: none"> <li>(a) The primary receptacle(s) shall be siftproof;</li> <li>(b) The secondary packaging shall be siftproof;</li> </ul>   |      |
| △                                    | <p>(c) If multiple fragile primary receptacles are placed in a single secondary packaging, they shall either be individually wrapped or separated to prevent contact between them; and</p>   |      |
|                                      | <p>(d) If there is any doubt as to whether or not residual liquid may be present in the primary receptacle during transport then a packaging suitable for liquids, including absorbent materials, shall be used.</p>   |      |



Part 4 – Packing and tank provisions

| P650 | PACKING INSTRUCTION <i>(continued)</i>  | P650 |
|------|---|------|
| △    | <p>(9) Refrigerated or frozen specimens: ice, dry ice and liquid nitrogen</p> <p>(a) When dry ice or liquid nitrogen is used as a coolant, the requirements of 5.5.3 shall apply. When used, ice shall be placed outside the secondary packagings or in the outer packaging or an overpack. Interior supports shall be provided to secure the secondary packagings in the original position. If ice is used, the outside packaging or overpack shall be leakproof; and</p> <p>(b) The primary receptacle and the secondary packaging shall maintain their integrity at the temperature of the refrigerant used as well as the temperatures and the pressures which could result if refrigeration were lost.</p> <p>(10) When packages are placed in an overpack, the package marks required by this packing instruction shall either be clearly visible or be reproduced on the outside of the overpack.</p> <p>(11) Infectious substances assigned to UN 3373 which are packed and marked in accordance with this packing instruction are not subject to any other provisions of this Code.</p> <p>(12) Clear instructions on filling and closing such packages shall be provided by packaging manufacturers and subsequent distributors to the consignor or to the person who prepares the package (e.g. patient) to enable the package to be correctly prepared for transport.</p> <p>(13) Other dangerous goods shall not be packed in the same packaging as class 6.2 infectious substances unless they are necessary for maintaining the viability, stabilizing or preventing degradation or neutralizing the hazards of the infectious substances. A quantity of 30 mL or less of dangerous goods included in classes 3, 8 or 9 may be packed in each primary receptacle containing infectious substances. When these small quantities of dangerous goods are packed with infectious substances in accordance with this packing instruction, no other provisions of the Code need be met.</p> <p><b>Additional provision:</b><br/>Alternative packagings for the transport of animal material may be authorized by the competent authority in accordance with the provisions of 4.1.3.7.</p> |      |

| P800 | PACKING INSTRUCTION   | P800                    |
|------|---|-------------------------|
|      | This instruction applies to UN Nos. 2803 and 2809.  |                         |
|      | The following packagings are authorized, provided the general provisions of 4.1.1 and 4.1.3 are met:  |                         |
|      | <p>(1) Pressure receptacles, provided that the general provisions of 4.1.3.6 are met.</p> <p>(2) Steel flasks or bottles with threaded closures with a capacity not exceeding 3.0 L; or</p> <p>(3) Combination packagings which conform to the following provisions:</p> <p>(a) Inner packagings shall comprise glass, metal or rigid plastics intended to contain liquids with a maximum net mass of 15 kg each.</p> <p>(b) The inner packagings shall be packed with sufficient cushioning material to prevent breakage.</p> <p>(c) Either the inner packagings or the outer packagings shall have inner liners or bags of strong leakproof and puncture-resistant material impervious to the contents and completely surrounding the contents to prevent it from escaping from the package irrespective of its position or orientation.</p> <p>(d) The following outer packagings and maximum net masses are authorized:</p> |                         |
|      | <b>Outer packaging</b>  | <b>Maximum net mass</b> |
|      | <b>Drums</b>  |                         |
|      | steel (1A1, 1A2)  | 400 kg                  |
|      | metal, other than steel or aluminium (1N1, 1N2)   | 400 kg                  |
|      | plastics (1H1, 1H2)   | 400 kg                  |
|      | plywood (1D)  | 400 kg                  |
|      | fibre (1G)  | 400 kg                  |
|      | <b>Boxes</b>  |                         |
|      | steel (4A)  | 400 kg                  |
|      | metal, other than steel or aluminium (4N)   | 400 kg                  |
|      | natural wood (4C1)  | 250 kg                  |
|      | natural wood with sift-proof walls (4C2)  | 250 kg                  |
|      | plywood (4D)  | 250 kg                  |
|      | reconstituted wood (4F)   | 125 kg                  |
|      | fibreboard (4G)   | 125 kg                  |
|      | expanded plastics (4H1)   | 60 kg                   |
|      | solid plastics (4H2)  | 125 kg                  |
|      | <b>Special packing provision:</b>   |                         |
| △    | <p><b>PP41</b> For UN 2803, when it is necessary to transport gallium at low temperatures in order to maintain it in a completely solid state, the above packagings may be overpacked in a strong, water-resistant outer packaging which contains dry ice or other means of refrigeration. When dry ice or other means of refrigeration presenting a risk of asphyxiation are used as a coolant, the requirements of 5.5.3 shall apply. If a refrigerant is used, all of the above materials used in the packaging of gallium shall be chemically and physically resistant to the refrigerant and shall have impact resistance at the low temperatures of the refrigerant employed. If dry ice is used, the outer packaging shall permit the release of carbon dioxide gas. Interior supports shall be provided to prevent movement after the dissipation of the refrigerant.</p>   |                         |



Chapter 4.1 – Use of packagings, including IBCs and large packagings

| P801  | PACKING INSTRUCTION | P801 |
|---|---------------------|------|
| This instruction applies to UN Nos. 2794, 2795 and 3028.  |                     |      |
| <p>The following packagings are authorized, provided that the provisions of 4.1.1.1, 4.1.1.2, 4.1.1.6, and 4.1.3 are met:</p> <p>(1) Rigid outer packagings, wooden slatted crates or pallets.<br/>           Additionally, the following conditions shall be met:</p> <ul style="list-style-type: none"> <li>(a) Batteries' stacks shall be in tiers separated by a layer of electrically non-conductive material;</li> <li>(b) Battery terminals shall not support the weight of other superimposed elements;</li> <li>(c) Batteries shall be packaged or secured to prevent inadvertent movement;</li> <li>(d) Batteries shall not leak under normal conditions of transport or appropriate measures shall be taken to prevent the release of electrolyte from the package (e.g. individually packaging batteries or other equally effective methods); and</li> <li>(e) Batteries shall be protected against short circuits.</li> </ul> <p>(2) Stainless steel or plastics bins may also be used to transport used batteries.<br/>           Additionally, the following conditions shall be met:</p> <ul style="list-style-type: none"> <li>(a) The bins shall be resistant to the electrolyte that was contained in the batteries;</li> <li>(b) The bins shall not be filled to a height greater than the height of their sides;</li> <li>(c) The outside of the bins shall be free of residues of electrolyte contained in the batteries;</li> <li>(d) Under normal conditions of transport, no electrolyte shall leak from the bins;</li> <li>(e) Measures shall be taken to ensure that filled bins cannot lose their content; and</li> <li>(f) Measures shall be taken to prevent short circuits (e.g. batteries are discharged, individual protection of the battery terminals, etc.).</li> </ul> <p><b>Note:</b> The packagings authorized in (1) and (2) may exceed a net mass of 400 kg (see 4.1.3.3).</p> |                     |      |

| P802  | PACKING INSTRUCTION | P802 |
|---|---------------------|------|
| The following packagings are authorized, provided the general provisions of 4.1.1 and 4.1.3 are met:  |                     |      |
| <p>(1) Combination packagings<br/>           Outer packagings: 1A1, 1A2, 1B1, 1B2, 1N1, 1N2, 1H1, 1H2, 1D, 1G, 4A, 4B, 4N, 4C1, 4C2, 4D, 4F, 4G or 4H2;<br/>           maximum net mass: 75 kg.<br/>           Inner packagings: glass or plastics; maximum capacity: 10 L.</p> <p>(2) Combination packagings<br/>           Outer packagings: 1A1, 1A2, 1B1, 1B2, 1N1, 1N2, 1H1, 1H2, 1D, 1G, 4A, 4B, 4N, 4C1, 4C2, 4D, 4F, 4G or 4H2;<br/>           maximum net mass: 125 kg<br/>           Inner packagings: metal; maximum capacity: 40 L</p> <p>(3) Composite packagings: Glass receptacle in steel, aluminium or plywood drum (6PA1, 6PB1 or 6PD1) or in a steel, aluminium or wood box or in wickerwork hamper (6PA2, 6PB2, 6PC or 6PD2) or in solid plastics packaging (6PH2); maximum capacity: 60 L.</p> <p>(4) Steel drums (1A1) with a maximum capacity of 250 L.</p> <p>(5) Pressure receptacles may be used provided that the general provisions of 4.1.3.6 are met.</p> |                     |      |
| <b>Special packing provisions:</b>  |                     |      |
| <p><b>PP79</b> For UN 1790 with more than 60% but not more than 85% hydrogen fluoride, see P001.</p> <p><b>PP81</b> For UN 1790 with not more than 85% hydrogen fluoride and UN 2031 with more than 55% nitric acid, the permitted use of plastics drums and jerricans as single packagings shall be two years from their date of manufacture.</p>  |                     |      |

| P803                                 | PACKING INSTRUCTION  | P803 |
|--------------------------------------|--|------|
| This instruction applies to UN 2028. |  |      |
| △                                    | <p>The following packagings are authorized, provided that the general provisions of 4.1.1 and 4.1.3 are met:</p> <ul style="list-style-type: none"> <li>Drums (1A2, 1B2, 1N2, 1H2, 1D, 1G);</li> <li>Boxes (4A, 4B, 4N, 4C1, 4C2, 4D, 4F, 4G, 4H2).</li> </ul> <p>Packagings shall conform to the packing group II performance level.</p> <p>Articles shall be individually packaged and separated from each other using partitions, dividers, inner packagings or cushioning material to prevent inadvertent discharge during normal conditions of transport.</p> <p>Maximum net mass: 75 kg.</p> |      |





## Part 4 – Packing and tank provisions

| P804   | PACKING INSTRUCTION | P804 |
|--|---------------------|------|
| This instruction applies to UN 1744.   |                     |      |
| The following packagings are authorized provided the general provisions of 4.1.1 and 4.1.3 are met and the packagings are hermetically sealed:   |                     |      |
| <p>(1) Combination packagings with a maximum gross mass of 25 kg, consisting of one or more glass inner packaging(s) with a maximum capacity of 1.3 L each and filled to no more than 90% of their capacity; the closure(s) of which shall be physically held in place by any means capable of preventing back-off or loosening by impact or vibration during transport, individually placed in:</p> <p>(a) metal or rigid plastics receptacles together with cushioning and absorbent material sufficient to absorb the entire contents of the glass inner packaging(s), further packed in:</p> <p>(b) 1A1, 1A2, 1B1, 1B2, 1N1, 1N2, 1H1, 1H2, 1D, 1G, 4A, 4B, 4N, 4C1, 4C2, 4D, 4F, 4G or 4H2 outer packagings.</p> <p>(2) Combination packagings consisting of metal or polyvinylidene fluoride (PVDF) inner packagings, not exceeding 5 L in capacity individually packed with absorbent material sufficient to absorb the contents and inert cushioning material in 1A1, 1A2, 1B1, 1B2, 1N1, 1N2, 1H1, 1H2, 1D, 1G, 4A, 4B, 4N, 4C1, 4C2, 4D, 4F, 4G or 4H2 outer packagings with a maximum gross mass of 75 kg. Inner packagings shall not be filled to more than 90% of their capacity. The closure of each inner packaging shall be physically held in place by any means capable of preventing back-off or loosening of the closure by impact or vibration during transport.</p> <p>(3) Packagings consisting of:</p> <p>Outer packagings:</p> <p>Steel or plastics drums (1A1, 1A2, 1H1 or 1H2) tested in accordance with the test requirements in 6.1.5 at a mass corresponding to the mass of the assembled package either as a packaging intended to contain inner packagings, or as a single packaging intended to contain solids or liquids, and marked accordingly;</p> <p>Inner packagings:</p> <p>Drums and composite packagings (1A1, 1B1, 1N1, 1H1 or 6HA1) meeting the requirements of chapter 6.1 for single packagings, subject to the following conditions:</p> <p>(a) The hydraulic pressure test shall be conducted at a pressure of at least 300 kPa (3 bar) (gauge pressure);</p> <p>(b) The design and production leakproofness tests shall be conducted at a test pressure of 30 kPa (0.3 bar);</p> <p>(c) They shall be isolated from the outer drum by the use of inert shock-mitigating cushioning material which surrounds the inner packaging on all sides;</p> <p>(d) Their capacity shall not exceed 125 L;</p> <p>(e) Closures shall be of a screw type that are:</p> <p>(i) Physically held in place by any means capable of preventing back-off or loosening of the closure by impact or vibration during transport;</p> <p>(ii) Provided with a cap seal;</p> <p>(f) The outer and inner packagings shall be subjected periodically to an internal inspection and leakproofness test according to (b) at intervals of not more than two and a half years; and</p> <p>(g) The outer and inner packagings shall bear in clearly legible and durable characters:</p> <p>(i) the date (month, year) of the initial test and the latest periodic test and inspection of the inner packaging; and</p> <p>(ii) the name or authorized symbol of the expert performing the tests and inspections.</p> <p>(4) Pressure receptacles, provided that the general provisions of 4.1.3.6 are met.</p> <p>(a) They shall be subjected to an initial test and periodic tests every 10 years at a pressure of not less than 1 MPa (10 bar) (gauge pressure);</p> <p>(b) They shall be subjected periodically to an internal inspection and leakproofness test at intervals of not more than two and a half years;</p> <p>(c) They may not be equipped with any pressure relief device;</p> <p>(d) Each pressure receptacle shall be closed with a plug or valve(s) fitted with a secondary closure device; and</p> <p>(e) The materials of construction for the pressure receptacle, valves, plugs, outlet caps, luting and gaskets shall be compatible with each other and with the contents.</p> |                     |      |

Chapter 4.1 – Use of packagings, including IBCs and large packagings

| P900   | PACKING INSTRUCTION   | P900 |
|--|---|------|
| This instruction applies to UN 2216.   |   |      |
| <p>The following packagings are authorized, provided the general provisions of 4.1.1 and 4.1.3 are met:</p> <p>(1) Packagings according to P002; or</p> <p>(2) Bags (5H1, 5H2, 5H3, 5H4, 5L1, 5L2, 5L3, 5M1 or 5M2) with a maximum net mass of 50 kg.</p> <p>Fish meal may also be transported unpackaged when it is packed in closed cargo transport units and the free air space has been restricted to a minimum.</p>   |   |      |
| P901   | PACKING INSTRUCTION   | P901 |
| This instruction applies to UN 3316.   |   |      |
| <p>The following combination packagings are authorized provided the general provisions of 4.1.1 and 4.1.3 are met:</p> <p style="padding-left: 40px;">Drums (1A1, 1A2, 1B1, 1B2, 1N1, 1N2, 1H1, 1H2, 1D, 1G);</p> <p style="padding-left: 40px;">Boxes (4A, 4B, 4N, 4C1, 4C2, 4D, 4F, 4G, 4H1, 4H2);</p> <p style="padding-left: 40px;">Jerricans (3A1, 3A2, 3B1, 3B2, 3H1, 3H2).</p> <p>Packagings shall conform to the performance level consistent with the packing group assigned to the kit as a whole (see 3.3.1, special provision 251). Where the kit contains only dangerous goods to which no packing group is assigned, packagings shall meet Packing Group II performance level.</p> <p>Maximum quantity of dangerous goods per outer packaging: 10 kg excluding the mass of any carbon dioxide, solid (dry ice) used as a refrigerant.</p> <p>■ If dry ice is used as a coolant, the requirements of 5.5.3 shall apply.</p> |   |      |
| <p><b>Additional requirement:</b></p> <p>Dangerous goods in kits shall be packed in inner packagings which shall be protected from other materials in the kit.</p>   |   |      |
| P902   | PACKING INSTRUCTION   | P902 |
| △  | This instruction applies to UN Nos. 3268 and 3559.  |      |
| △  | <p>(1) Packaged articles:</p> <p>The following packagings are authorized provided the general provisions of 4.1.1 and 4.1.3 are met:</p> <p style="padding-left: 40px;">Drums (1A2, 1B2, 1N2, 1H2, 1D, 1G);</p> <p style="padding-left: 40px;">Boxes (4A, 4B, 4N, 4C1, 4C2, 4D, 4F, 4G, 4H1, 4H2);</p> <p style="padding-left: 40px;">Jerricans (3A2, 3B2, 3H2).</p> <p>Packagings shall conform to the packing group III performance level.</p> <p>The packagings shall be designed and constructed so as to prevent movement of the articles and inadvertent operation during normal conditions of transport.</p> |      |
| △  | (2) Unpackaged articles:  |      |
| △  | Except for UN 3559, the articles may also be transported unpackaged in dedicated handling devices, vehicles or containers when moved to, from, or between where they are manufactured and an assembly plant including intermediate handling locations.  |      |
| <p><b>Additional requirement:</b></p> <p>Any pressure receptacle shall be in accordance with the requirements of the competent authority for the substance(s) contained therein.</p>   |   |      |



Part 4 – Packing and tank provisions

| P903 | PACKING INSTRUCTION  | P903 |
|------|--|------|
| △    | This instruction applies to UN Nos. 3090, 3091, 3480, 3481, 3551 and 3552.   |      |
| △    | <p>For the purpose of this packing instruction, “equipment” means apparatus for which the cells or batteries will provide electrical power for its operation. The following packagings are authorized provided that the general provisions of 4.1.1 and 4.1.3 are met:</p> <p>(1) For cells and batteries:<br/> Drums (1A2, 1B2, 1N2, 1H2, 1D, 1G);<br/> Boxes (4A, 4B, 4N, 4C1, 4C2, 4D, 4F, 4G, 4H1, 4H2);<br/> Jerricans (3A2, 3B2, 3H2).</p> <p>Cells or batteries shall be packed in packagings so that the cells or batteries are protected against damage that may be caused by the movement or placement of the cells or batteries within the packaging.<br/> Packagings shall conform to the packing group II performance level.</p> <p>(2) In addition for a cell or a battery with a gross mass of 12 kg or more employing a strong, impact resistant outer casing:<br/> (a) Strong outer packagings;<br/> (b) Protective enclosures (e.g. fully enclosed or wooden slatted crates); or<br/> (c) Pallets or other handling devices.</p> <p>Cells or batteries shall be secured to prevent inadvertent movement, and the terminals shall not support the weight of other superimposed elements.<br/> Packagings need not meet the requirements of 4.1.1.3.</p> <p>(3) For cells or batteries packed with equipment:<br/> Packagings conforming to the requirements in paragraph (1) of this packing instruction, then placed with the equipment in an outer packaging; or<br/> Packagings that completely enclose the cells or batteries, then placed with equipment in a packaging conforming to the requirements in paragraph (1) of this packing instruction.<br/> The equipment shall be secured against movement within the outer packaging.</p> <p>(4) For cells or batteries contained in equipment:<br/> Strong outer packagings constructed of suitable material, and of adequate strength and design in relation to the packaging capacity and its intended use. They shall be constructed in such a manner as to prevent accidental operation during transport. Packagings need not meet the requirements of 4.1.1.3.<br/> Large equipment can be offered for transport unpackaged or on pallets when the cells or batteries are afforded equivalent protection by the equipment in which they are contained.<br/> When intentionally active, devices such as radio frequency identification (RFID) tags, watches and temperature loggers, which are not capable of generating a dangerous evolution of heat, may be transported in strong outer packagings.</p> <p>(5) For packaging containing both cells or batteries packed with equipment and contained in equipment:<br/> (a) For cells and batteries, packagings that completely enclose the cells or batteries, then placed with equipment in a packaging conforming to the requirements in paragraph (1) of this packing instruction; or<br/> (b) Packagings conforming to the requirements in paragraph (1) of this packing instruction, then placed with the equipment in a strong outer packaging constructed of suitable material, and of adequate strength and design in relation to the packaging capacity and its intended use. The outer packaging shall be constructed in such a manner as to prevent accidental operation during transport and need not meet the requirements of 4.1.1.3.<br/> The equipment shall be secured against movement within the outer packaging.<br/> When intentionally active, devices such as radio frequency identification (RFID) tags, watches and temperature loggers, which are not capable of generating a dangerous evolution of heat, may be transported in strong outer packagings.</p> <p><b>Note:</b> The packagings authorized in (2), (4) and (5) may exceed a net mass of 400 kg (see 4.1.3.3).</p> |      |
| △    | <p><b>Additional requirement:</b><br/> Cells or batteries shall be protected against short circuit.</p>  |      |



| P904  | PACKING INSTRUCTION | P904 |
|---|---------------------|------|
| <p>This instruction applies to UN 3245.</p>   |                     |      |
| <p>The following packagings are authorized:</p> <ol style="list-style-type: none"> <li>(1) Packagings meeting the provisions of 4.1.1.1, 4.1.1.2, 4.1.1.4, 4.1.1.8 and 4.1.3 and so designed that they meet the construction requirements of 6.1.4. Outer packagings constructed of suitable material, and of adequate strength and design in relation to the packaging capacity and its intended use, shall be used. Where this packing instruction is used for the transport of inner packagings of combination packagings the packaging shall be designed and constructed to prevent inadvertent discharge during normal conditions of transport.</li> <li>(2) Packagings, which need not conform to the packaging test requirements of part 6, but conforming to the following:             <ol style="list-style-type: none"> <li>(a) An inner packaging comprising:                 <ol style="list-style-type: none"> <li>(i) primary receptacle(s) and a secondary packaging, the primary receptacle(s) or the secondary packaging shall be leakproof for liquids or siftproof for solids;</li> <li>(ii) for liquids, absorbent material placed between the primary receptacle(s) and the secondary packaging. The absorbent material shall be in a quantity sufficient to absorb the entire contents of the primary receptacle(s) so that any release of the liquid substance will not compromise the integrity of the cushioning material or of the outer packaging;</li> <li>(iii) if multiple fragile primary receptacles are placed in a single secondary packaging they shall be individually wrapped or separated to prevent contact between them;</li> </ol> </li> <li>(b) An outer packaging shall be strong enough for its capacity, mass and intended use, and with a smallest external dimension of at least 100 mm.</li> </ol> </li> </ol> <p>For transport, the mark illustrated below shall be displayed on the external surface of the outer packaging on a background of a contrasting colour and shall be clearly visible and legible. The mark shall be in the form of a square set at an angle of 45° (diamond-shaped) with each side having a length of at least 50 mm; the width of the line shall be at least 2 mm and the letters and numbers shall be at least 6 mm high.</p> <div style="text-align: center;">  </div> |                     |      |
| <p><b>Additional requirement:</b><br/>When dry ice or liquid nitrogen is used as a coolant, the requirements of 5.5.3 shall apply. When used, ice shall be placed outside the secondary packagings or in the outer packaging or an overpack. Interior supports shall be provided to secure the secondary packaging in the original position. If ice is used, the outside packaging or overpack shall be leakproof.</p>  |                     |      |



Part 4 – Packing and tank provisions

| P905 | PACKING INSTRUCTION  | P905 |
|------|--|------|
| △    | <p>This instruction applies to UN Nos. 2990 and 3072.</p> <p>Any suitable packaging is authorized, provided the general provisions of 4.1.1 and 4.1.3 are met, except that packagings need not conform to the provisions of part 6.</p> <p><b>Note:</b> The packagings authorized may exceed a net mass of 400 kg (see 4.1.3.3).</p> <p>When the life-saving appliances are constructed to incorporate or are contained in rigid outer weatherproof casings (such as for lifeboats), they may be transported unpackaged.</p> <p><b>Additional provisions:</b></p> <ol style="list-style-type: none"> <li>1 All dangerous substances and articles contained as equipment within the appliances shall be secured to prevent inadvertent movement and in addition:               <ol style="list-style-type: none"> <li>(a) signal devices of class 1 shall be packed in plastics or fibreboard inner packagings;</li> <li>(b) gases (class 2.2) shall be contained in cylinders as specified by the competent authority, which may be connected to the appliance;</li> <li>(c) electric storage batteries (class 8) and lithium batteries and sodium ion batteries (class 9) shall be disconnected or electrically isolated and secured to prevent any spillage of liquid; and</li> <li>(d) small quantities of other dangerous substances (for example in classes 3, 4.1 and 5.2) shall be packed in strong inner packagings.</li> </ol> </li> <li>2 Preparation for transport and packaging shall include provisions to prevent any accidental inflation of the appliance.</li> </ol>  |      |
| △    | <p>This instruction applies to UN Nos. 2315, 3151, 3152 and 3432.</p> <p>The following packagings are authorized, provided the general provisions of 4.1.1 and 4.1.3 are met:</p> <ol style="list-style-type: none"> <li>(1) For liquids and solids containing or contaminated with PCBs, polyhalogenated biphenyls, polyhalogenated terphenyls or halogenated monomethyldiphenylmethanes: Packagings in accordance with P001 or P002, as appropriate.</li> <li>(2) For transformers and condensers and other articles:               <ol style="list-style-type: none"> <li>(a) Packagings in accordance with packing instructions P001 or P002. The articles shall be secured with suitable cushioning material to prevent inadvertent movement during normal conditions of transport; or</li> <li>(b) Leakproof packagings which are capable of containing, in addition to the articles, at least 1.25 times the volume of the liquid PCBs, polyhalogenated biphenyls, polyhalogenated terphenyls or halogenated monomethyldiphenylmethanes present in them. There shall be sufficient absorbent material in the packagings to absorb at least 1.1 times the volume of liquid which is contained in the articles. In general, transformers and condensers shall be carried in leakproof metal packagings which are capable of holding, in addition to the transformers and condensers, at least 1.25 times the volume of the liquid present in them.</li> </ol> </li> </ol> <p><b>Note 1:</b> The packagings authorized may exceed a net mass of 400 kg (see 4.1.3.3).</p> <p>Notwithstanding the above, liquids and solids not packaged in accordance with P001 and P002 and unpackaged transformers and condensers may be transported in cargo transport units fitted with a leakproof metal tray to a height of at least 800 mm, containing sufficient inert absorbent material to absorb at least 1.1 times the volume of any free liquid.</p> <p><b>Note 2:</b> The packagings authorized may exceed a net mass of 400 kg (see 4.1.3.3).</p> <p><b>Additional provision:</b></p> <p>Adequate provisions shall be taken to seal the transformers and condensers to prevent leakage during normal conditions of transport.</p> |      |
| △    | <p>This instruction applies to articles, such as machinery, apparatus or devices of UN No. 3363.</p> <p>If the article is constructed and designed so that the receptacles containing the dangerous goods are afforded adequate protection, an outer packaging is not required. Dangerous goods in an article shall otherwise be packed in outer packagings constructed of suitable material, and of adequate strength and design in relation to the packaging capacity and its intended use, and meeting the applicable requirements of 4.1.1.1.</p> <p>Receptacles containing dangerous goods shall conform to the general provisions in 4.1.1, except that 4.1.1.3, 4.1.1.4, 4.1.1.12 and 4.1.1.14 do not apply. For class 2.2 gases, the inner cylinder or receptacle, its contents and filling ratio shall be to the satisfaction of the competent authority of the country in which the cylinder or receptacle is filled.</p> <p>In addition, the manner in which receptacles are contained within the article shall be such that, under normal conditions of transport, damage to receptacles containing the dangerous goods is unlikely; and in the event of damage to the receptacles containing solid or liquid dangerous goods, no leakage of the dangerous goods from the article is possible (a leakproof liner may be used to satisfy this requirement). Receptacles containing dangerous goods shall be so installed, secured or cushioned as to prevent their breakage or leakage and so as to control their movement within the article during normal conditions of transport. Cushioning material shall not react dangerously with the content of the receptacles. Any leakage of the contents shall not substantially impair the protective properties of the cushioning material.</p> <p><b>Note:</b> The packagings authorized may exceed a net mass of 400 kg (see 4.1.3.3).</p>   |      |



Chapter 4.1 – Use of packagings, including IBCs and large packagings

| P908 | PACKING INSTRUCTION  | P908 |
|------|--|------|
| △    | <p>This instruction applies to damaged or defective cells and batteries, including those contained in equipment, of UN Nos. 3090, 3091, 3480, 3481, 3551 and 3552.</p> <p>The following packagings are authorized provided the general provisions for 4.1.1 and 4.1.3 are met:<br/>For cells and batteries and equipment containing cells and batteries:<br/>Drums (1A2, 1B2, 1N2, 1H2, 1D, 1G)<br/>Boxes (4A, 4B, 4N, 4C1, 4C2, 4D, 4F, 4G, 4H1, 4H2)<br/>Jerricans (3A2, 3B2, 3H2)</p> <p>Packagings shall conform to the packing group II performance level.</p> <p>■ Packagings shall also meet the following requirements:</p> <ul style="list-style-type: none"> <li>(a) Each damaged or defective cell or battery or equipment containing such cells or batteries shall be individually packed in inner packaging and placed inside of an outer packaging. The inner packaging or outer packaging shall be leakproof to prevent the potential release of electrolyte.</li> <li>(b) Each inner packaging shall be surrounded by sufficient non-combustible and electrically non-conductive thermal insulation material to protect against a dangerous evolution of heat.</li> <li>(c) Sealed packagings shall be fitted with a venting device when appropriate.</li> <li>(d) Appropriate measures shall be taken to minimize the effects of vibrations and shocks, prevent movement of the cells or batteries within the package that may lead to further damage and a dangerous condition during transport. Cushioning material that is non-combustible and electrically non-conductive may also be used to meet this requirement.</li> </ul> <p>△ (e) The non-combustibility of the thermal insulation material and the cushioning material shall be assessed according to a standard recognized in the country where the packaging is designed or manufactured.</p> <p>For leaking cells or batteries, sufficient inert absorbent material shall be added to the inner or outer packaging to absorb any release of electrolyte.</p> <p>A cell or battery with a net mass of more than 30 kg shall be limited to one cell or battery per outer packaging.</p> <p><b>Additional requirement:</b><br/>Cells or batteries shall be protected against short circuit.</p> |      |

Part 4 – Packing and tank provisions

| P909 | PACKING INSTRUCTION  | P909 |
|------|--|------|
| △    | <p>This instruction applies to UN Nos. 3090, 3091, 3480, 3481, 3551 and 3552 transported for disposal or recycling, either packed together with or packed without non-lithium batteries.</p> <p>(1) Cells and batteries shall be packed in accordance with the following:</p> <p>(a) The following packagings are authorized, provided that the general provisions of 4.1.1 and 4.1.3, are met:<br/>Drums (1A2, 1B2, 1N2, 1H2, 1D, 1G);<br/>Boxes (4A, 4B, 4N, 4C1, 4C2, 4D, 4F, 4G, 4H2); and<br/>Jerricans (3A2, 3B2, 3H2).</p> <p>(b) Packagings shall conform to the packing group II performance level.</p> <p>(c) Metal packagings shall be fitted with an electrically non-conductive lining material (e.g. plastics) of adequate strength for the intended use.</p>  |      |
| △    | <p>(2) However, lithium ion or sodium ion cells with a Watt-hour rating of not more than 20 Wh, lithium ion or sodium ion batteries with a Watt-hour rating of not more than 100 Wh, lithium metal cells with a lithium content of not more than 1 g and lithium metal batteries with an aggregate lithium content of not more than 2 g may be packed in accordance with the following:</p> <p>(a) In strong outer packaging up to 30 kg gross mass meeting the general provisions of 4.1.1, except 4.1.1.3, and 4.1.3.</p> <p>(b) Metal packagings shall be fitted with an electrically non-conductive lining material (e.g. plastics) of adequate strength for the intended use.</p> <p>(3) For cells or batteries contained in equipment, strong outer packagings constructed of suitable material, and of adequate strength and design in relation to the packaging capacity and its intended use, may be used. Packagings need not meet the requirements of 4.1.1.3. Equipment may also be offered for transport unpackaged or on pallets when the cells or batteries are afforded equivalent protection by the equipment in which they are contained.</p> <p>(4) In addition, for cells or batteries with a gross mass of 12 kg or more employing a strong, impact resistant outer casing, strong outer packagings constructed of suitable material and of adequate strength and design in relation to the packagings capacity and its intended use, may be used.<br/>Packagings need not meet the requirements of 4.1.1.3.</p> <p><b>Note:</b> The packagings authorized in (3) and (4) may exceed a net mass of 400 kg (see 4.1.3.3).</p> <p><b>Additional requirements:</b></p> <p>1 Cells and batteries shall be designed or packed to prevent short circuits and the dangerous evolution of heat.</p> <p>2 Protection against short circuits and the dangerous evolution of heat includes, but is not limited to:</p> <p>(a) individual protection of the battery terminals,</p> <p>(b) inner packaging to prevent contact between cells and batteries,</p> <p>(c) batteries with recessed terminals designed to protect against short circuits, or</p> <p>(d) the use of an electrically non-conductive and non-combustible cushioning material to fill empty space between the cells or batteries in the packaging.</p> <p>3 Cells and batteries shall be secured within the outer packaging to prevent excessive movement during transport (e.g. by using an electrically non-conductive and non-combustible cushioning material or through the use of a tightly closed plastics bag).</p> |      |



Chapter 4.1 – Use of packagings, including IBCs and large packagings

| P910 | PACKING INSTRUCTION   | P910 |
|------|---|------|
| △    | <p>This instruction applies to UN Nos. 3090, 3091, 3480, 3481, 3551 and 3552 production runs consisting of not more than 100 cells or batteries and to pre-production prototypes of cells or batteries when these prototypes are transported for testing.</p> <p>The following packagings are authorized provided that the general provisions of 4.1.1 and 4.1.3 are met:</p> <p>(1) For cells and batteries, including when packed with equipment:<br/>Drums (1A2, 1B2, 1N2, 1H2, 1D, 1G);<br/>Boxes (4A, 4B, 4N, 4C1, 4C2, 4D, 4F, 4G, 4H1, 4H2);<br/>Jerricans (3A2, 3B2, 3H2).<br/>Packagings shall conform to the packing group II performance level and shall meet the following requirements:</p> <p>(a) Batteries and cells, including equipment, of different sizes, shapes or masses shall be packaged in an outer packaging of a tested design type listed above provided the total gross mass of the package does not exceed the gross mass for which the design type has been tested;</p> <p>(b) Each cell or battery shall be individually packed in an inner packaging and placed inside an outer packaging;</p> <p>(c) Each inner packaging shall be completely surrounded by sufficient non-combustible and electrically non-conductive thermal insulation material to protect against a dangerous evolution of heat;</p> <p>(d) Appropriate measures shall be taken to minimize the effects of vibration and shocks and prevent movement of the cells or batteries within the package that may lead to damage and a dangerous condition during transport. Cushioning material that is non-combustible and electrically non-conductive may be used to meet this requirement;</p> |      |
| △    | <p>(e) The non-combustibility of the thermal insulation material and the cushioning material shall be assessed according to a standard recognized in the country where the packaging is designed or manufactured;</p> <p>(f) A cell or battery with a net mass of more than 30 kg shall be limited to one cell or battery per outer packaging.</p> <p>(2) For cells and batteries contained in equipment:<br/>Drums (1A2, 1B2, 1N2, 1H2, 1D, 1G);<br/>Boxes (4A, 4B, 4N, 4C1, 4C2, 4D, 4F, 4G, 4H1, 4H2);<br/>Jerricans (3A2, 3B2, 3H2).<br/>Packagings shall conform to the packing group II performance level and shall meet the following requirements:</p> <p>(a) Equipment of different sizes, shapes or masses shall be packaged in an outer packaging of a tested design type listed above provided the total gross mass of the package does not exceed the gross mass for which the design type has been tested;</p> <p>(b) The equipment shall be constructed or packaged in such a manner as to prevent accidental operation during transport;</p> <p>(c) Appropriate measures shall be taken to minimize the effects of vibration and shocks and prevent movement of the equipment within the package that may lead to damage and a dangerous condition during transport. When cushioning material is used to meet this requirement it shall be non-combustible and electrically non-conductive; and</p>   |      |
| △    | <p>(d) The non-combustibility of the cushioning material shall be assessed according to a standard recognized in the country where the packaging is designed or manufactured.</p> <p>(3) The equipment or the batteries may be transported unpackaged under conditions specified by the competent authority. Additional conditions that may be considered in the approval process include, but are not limited to:</p> <p>(a) The equipment or the battery shall be strong enough to withstand the shocks and loadings normally encountered during transport, including transshipment between cargo transport units and between cargo transport units and warehouses as well as any removal from a pallet for subsequent manual or mechanical handling; and</p> <p>(b) The equipment or the battery shall be fixed in cradles or crates or other handling devices in such a way that it will not become loose during normal conditions of transport.</p> <p><b>Note:</b> The packagings authorized may exceed a net mass of 400 kg (see 4.1.3.3).</p>   |      |
|      | <p><b>Additional requirements:</b></p>  |      |
| △    | <p>The cells and batteries shall be protected against short circuit. Protection against short circuits includes, but is not limited to,</p> <p>(a) individual protection of the battery terminals,</p> <p>(b) inner packaging to prevent contact between cells and batteries,</p> <p>(c) batteries with recessed terminals designed to protect against short circuits, or</p> <p>(d) the use of an electrically non-conductive and non-combustible cushioning material to fill empty space between the cells or batteries in the packaging.</p>   |      |



Part 4 – Packing and tank provisions

| P911 | PACKING INSTRUCTION  | P911 |
|------|--|------|
| △    | <p>This instruction applies to damaged or defective cells and batteries of UN Nos. 3090, 3091, 3480, 3481, 3551 and 3552 liable to rapidly disassemble, dangerously react, produce a flame or a dangerous evolution of heat or a dangerous emission of toxic, corrosive or flammable gases or vapours under normal conditions of transport.</p> <p>The following packagings are authorized, provided that the general provisions of 4.1.1 and 4.1.3 are met:<br/>For cells and batteries and equipment containing cells and batteries:<br/>Drums (1A2, 1B2, 1N2, 1H2, 1D, 1G);<br/>Boxes (4A, 4B, 4N, 4C1, 4C2, 4D, 4F, 4G, 4H1, 4H2);<br/>Jerricans (3A2, 3B2, 3H2).</p> <p>The packagings shall conform to the packing group I performance level.</p> <p>(1) The packaging shall be capable of meeting the following additional performance requirements in case of rapid disassembly, dangerous reaction, production of a flame or a dangerous evolution of heat or a dangerous emission of toxic, corrosive or flammable gases or vapours of the cells or batteries:</p> <p>(a) The outside surface temperature of the completed package shall not have a temperature of more than 100°C. A momentary spike in temperature up to 200°C is acceptable;</p> <p>(b) No flame shall occur outside the package;</p> <p>(c) No projectiles shall exit the package;</p> <p>(d) The structural integrity of the package shall be maintained;</p> <p>(e) The packagings shall have a gas management system (e.g. filter system, air circulation, containment for gas, gas tight packaging, etc.), as appropriate.</p> <p>(2) The additional packaging performance requirements shall be verified by a test as specified by the competent authority.*<br/>A verification report shall be available on request. As a minimum requirement, the cell or battery name, the cell or battery number, the mass, type, energy content of the cells or batteries, the packaging identification and the test data according to the verification method as specified by the competent authority shall be listed in the verification report.</p> <p>(3) When dry ice or liquid nitrogen is used as a coolant, the requirements of section 5.5.3 shall apply. The inner packaging and outer packaging shall maintain their integrity at the temperature of the refrigerant used as well as the temperatures and the pressures which could result if refrigeration were lost.</p>  |      |
|      | <p><b>Additional requirement:</b><br/>Cells or batteries shall be protected against short circuit.</p>   |      |
| △    | <p>* The following criteria, as relevant, may be considered to assess the performance of the packaging:</p> <p>(a) The assessment shall be done under a quality management system (as described, e.g. in section 2.9.4.5) allowing for the traceability of tests results, reference data and characterization models used;</p> <p>(b) The list of hazards expected in case of thermal runaway for the cell or battery type, in the condition it is transported (e.g. usage of an inner packaging, state of charge (SOC), use of sufficient non-combustible, electrically non-conductive and absorbent cushioning material, etc.), shall be clearly identified and quantified; the reference list of possible hazards for cells or batteries (e.g. rapidly disassemble, dangerously react, produce a flame or a dangerous evolution of heat or a dangerous emission of toxic, corrosive or flammable gases or vapours) can be used for this purpose. The quantification of these hazards shall rely on available scientific literature;</p> <p>(c) The mitigating effects of the packaging shall be identified and characterized, based on the nature of the protections provided and the construction material properties. A list of technical characteristics and drawings shall be used to support this assessment (density [kg·m<sup>-3</sup>], specific heat capacity [J·kg<sup>-1</sup>·K<sup>-1</sup>], heating value [kJ·kg<sup>-1</sup>], thermal conductivity [W·m<sup>-1</sup>·K<sup>-1</sup>], melting temperature and flammability temperature [K], heat transfer coefficient of the outer packaging [W·m<sup>-2</sup>·K<sup>-1</sup>], ...);</p> <p>(d) The test and any supporting calculations shall assess the result of a thermal runaway of the cell or battery inside the packaging in the normal conditions of transport;</p> <p>(e) In case the SOC of the cell or battery is not known, the assessment used shall be done with the highest possible SOC corresponding to the cell or battery use conditions;</p> <p>(f) The surrounding conditions in which the packaging may be used and transported shall be described (including for possible consequences of gas or smoke emissions on the environment, such as ventilation or other methods) according to the gas management system of the packaging;</p> <p>(g) The tests or the model calculation shall consider the worst case scenario for the thermal runaway triggering and propagation inside the cell or battery: this scenario includes the worst possible failure in the normal transport condition, the maximum heat and flame emissions for the possible propagation of the reaction;</p> <p>(h) These scenarios shall be assessed over a period long enough to allow all the possible consequences to occur (e.g. 24 hours).</p> <p>(i) In the case of multiple batteries and multiple items of equipment containing batteries, additional requirements, such as the maximum number of batteries and items of equipment, the total maximum energy content of the batteries, and the configuration inside the package, including separations and protections of the parts, shall be considered.</p> |      |



Chapter 4.1 – Use of packagings, including IBCs and large packagings

| P912   | PACKING INSTRUCTION | P912 |
|--|---------------------|------|
| <p>This instruction applies to UN Nos. 3556, 3557 and 3558.</p>  |                     |      |
| <p>The vehicle shall be secured in a strong, rigid outer packaging constructed of suitable material, and of adequate strength and design in relation to the packaging capacity and its intended use. It shall be constructed in such a manner as to prevent accidental operation during transport. Packagings need not meet the requirements of 4.1.1.3. The vehicle shall be secured by means capable of restraining the vehicle in the outer packaging to prevent any movement during transport which would change the orientation or cause the battery in the vehicle to be damaged.</p> <p>Vehicles transported in a packaging may have some parts of the vehicle, other than the battery, detached from its frame to fit into the packaging.</p> <p>Note: The packagings may exceed a net mass of 400 kg (see 4.1.3.3).</p> <p>Vehicles with an individual net mass of 30 kg or more:</p> <ul style="list-style-type: none"> <li>(a) may be loaded into crates or secured to pallets;</li> <li>(b) may be transported unpackaged providing that the vehicle is capable of remaining upright during transport without additional support and the vehicle provides adequate protection to the battery so that no damage to the battery can occur; or</li> <li>(c) where the vehicles have the potential to topple over during transport (e.g. motor cycles), may be transported unpackaged in a cargo transport unit fitted out with the means to prevent toppling in transport, such as by the use of bracing, frames or racking.</li> </ul> |                     |      |

Part 4 – Packing and tank provisions

4.1.4.2 Packing instructions concerning the use of IBCs

| IBC01  | PACKING INSTRUCTION | IBC01 |
|--|---------------------|-------|
| The following IBCs are authorized, provided the general provisions of 4.1.1, 4.1.2 and 4.1.3 are met:<br>Metal (31A, 31B and 31N). |                     |       |

| IBC02   | PACKING INSTRUCTION   | IBC02 |
|---|---|-------|
| The following IBCs are authorized, provided the general provisions of 4.1.1, 4.1.2 and 4.1.3 are met:<br>Metal (31A, 31B and 31N);<br>Rigid plastics (31H1 and 31H2);<br>Composite (31HZ1). |   |       |
| <b>Special packing provisions:</b>  |   |       |
| <b>B5</b>   | For UN Nos. 1791, 2014, 2984 and 3149, IBCs shall be provided with a device to allow venting during transport. The inlet to the venting device shall be sited in the vapour space of the IBC under maximum filling conditions during transport. |       |
| <b>B8</b>   | The pure form of this substance shall not be transported in IBCs since it is known to have a vapour pressure of more than 110 kPa at 50°C or 130 kPa at 55°C.   |       |
| <b>B15</b>  | For UN 2031 with more than 55% nitric acid, the permitted use of rigid plastics IBCs and of rigid plastics inner receptacles of composite IBCs shall be two years from their date of manufacture.   |       |
| <b>B16</b>  | For UN 3375, IBCs of type 31A and 31N are not allowed without competent authority approval.   |       |
| <b>B20</b>  | For UN Nos. 1716, 1717, 1736, 1737, 1738, 1742, 1743, 1755, 1764, 1768, 1776, 1778, 1782, 1789, 1790, 1796, 1826, 1830, 1832, 2031, 2308, 2353, 2513, 2584, 2796 and 2817 coming under PG II, IBCs shall be fitted with two shut-off devices.   |       |

| IBC03  | PACKING INSTRUCTION   | IBC03 |
|--|---|-------|
| The following IBCs are authorized, provided the general provisions of 4.1.1, 4.1.2 and 4.1.3 are met:<br>Metal (31A, 31B and 31N);<br>Rigid plastics (31H1 and 31H2);<br>Composite (31HZ1 and 31HA2, 31HB2, 31HN2, 31HD2 and 31HH2). |   |       |
| <b>Special packing provisions:</b>   |   |       |
| <b>B8</b>  | The pure form of this substance shall not be transported in IBCs since it is known to have a vapour pressure of more than 110 kPa at 50°C or 130 kPa at 55°C.   |       |
| △ <b>B11</b>   | Notwithstanding the provisions of the second paragraph of 4.1.1.10, UN 2672 ammonia solution in concentrations not exceeding 25% may be transported in IBCs.  |       |
| <b>B19</b>   | For UN Nos. 3532 and 3534, IBCs shall be designed and constructed to permit the release of gas or vapour to prevent a build-up of pressure that could rupture the IBCs in the event of loss of stabilization. |       |

| IBC04  | PACKING INSTRUCTION   | IBC04 |
|--|---|-------|
| The following IBCs are authorized, provided the general provisions of 4.1.1, 4.1.2 and 4.1.3 are met:<br>Metal (11A, 11B, 11N, 21A, 21B, 21N, 31A, 31B and 31N). |   |       |
| <b>Special packing provision:</b>  |   |       |
| <b>B1</b>  | For packing group I substances, IBCs shall be carried in closed cargo transport units or in freight containers/ vehicles, which shall have rigid sides or fences at least to the height of the IBC. |       |

| IBC05  | PACKING INSTRUCTION  | IBC05 |
|--|--|-------|
| The following IBCs are authorized, provided the general provisions of 4.1.1, 4.1.2 and 4.1.3 are met:<br>Metal (11A, 11B, 11N, 21A, 21B, 21N, 31A, 31B and 31N);<br>Rigid plastics (11H1, 11H2, 21H1, 21H2, 31H1 and 31H2);<br>Composite (11HZ1, 21HZ1 and 31HZ1). |  |       |
| <b>Special packing provisions:</b>   |  |       |
| <b>B1</b>  | For packing group I substances, IBCs shall be carried in closed cargo transport units or in freight containers/ vehicles, which shall have rigid sides or fences at least to the height of the IBC.  |       |
| <b>B21</b>   | For solid substances in IBCs other than metal or rigid plastics IBCs, the IBCs shall be carried in closed cargo transport units or in freight containers/vehicles, which shall have rigid sides or fences at least to the height of the IBC. |       |



Chapter 4.1 – Use of packagings, including IBCs and large packagings

| IBC06  | PACKING INSTRUCTION  | IBC06 |
|--|--|-------|
| The following IBCs are authorized, provided the general provisions of 4.1.1, 4.1.2 and 4.1.3 are met:<br>Metal (11A, 11B, 11N, 21A, 21B, 21N, 31A, 31B and 31N);<br>Rigid plastics (11H1, 11H2, 21H1, 21H2, 31H1 and 31H2);<br>Composite (11HZ1, 11HZ2, 21HZ1, 21HZ2 and 31HZ1). |  |       |
| <b>Additional provision:</b><br>Where the solid may become liquid during transport see 4.1.3.4.  |  |       |
| <b>Special packing provisions:</b>   |  |       |
| <b>B1</b>  | For packing group I substances, IBCs shall be carried in closed cargo transport units or in freight containers/vehicles, which shall have rigid sides or fences at least to the height of the IBC.   |       |
| <b>B12</b>   | For UN 2907, IBCs shall meet the packing group II performance level. IBCs meeting the test criteria of packing group I shall not be used.  |       |
| <b>B21</b>   | For solid substances in IBCs other than metal or rigid plastics IBCs, the IBCs shall be carried in closed cargo transport units or in freight containers/vehicles, which shall have rigid sides or fences at least to the height of the IBC. |       |

| IBC07  | PACKING INSTRUCTION  | IBC07 |
|--|--|-------|
| The following IBCs are authorized, provided the general provisions of 4.1.1, 4.1.2 and 4.1.3 are met:<br>Metal (11A, 11B, 11N, 21A, 21B, 21N, 31A, 31B and 31N);<br>Rigid plastics (11H1, 11H2, 21H1, 21H2, 31H1 and 31H2);<br>Composite (11HZ1, 11HZ2, 21HZ1, 21HZ2 and 31HZ1);<br>Wooden (11C, 11D and 11F). |  |       |
| <b>Additional provisions:</b><br>1 Where the solid may become liquid during transport see 4.1.3.4.<br>2 Liners of wooden IBCs shall be sift-proof.   |  |       |
| <b>Special packing provisions:</b>   |  |       |
| <b>B1</b>  | For packing group I substances, IBCs shall be carried in closed cargo transport units or in freight containers/vehicles, which shall have rigid sides or fences at least to the height of the IBC.   |       |
| <b>B4</b>  | Flexible, fibreboard or wooden IBCs shall be sift-proof and water-resistant or shall be fitted with a sift-proof and water-resistant liner.  |       |
| <b>B18</b>   | For UN Nos. 3531 and 3533, IBCs shall be designed and constructed to permit the release of gas or vapour to prevent a build-up of pressure that could rupture the IBCs in the event of loss of stabilization.                                |       |
| <b>B21</b>   | For solid substances in IBCs other than metal or rigid plastics IBCs, the IBCs shall be carried in closed cargo transport units or in freight containers/vehicles, which shall have rigid sides or fences at least to the height of the IBC. |       |
| <b>B40</b>   | UN 3550 may be transported in flexible IBCs (13H3 or 13H4) with siftproof liners to prevent any egress of dust during transport.   |       |

| IBC08   | PACKING INSTRUCTION  | IBC08 |
|---|--|-------|
| The following IBCs are authorized, provided the general provisions of 4.1.1, 4.1.2 and 4.1.3 are met:<br>Metal (11A, 11B, 11N, 21A, 21B, 21N, 31A, 31B and 31N);<br>Rigid plastics (11H1, 11H2, 21H1, 21H2, 31H1 and 31H2);<br>Composite (11HZ1, 11HZ2, 21HZ1, 21HZ2 and 31HZ1);<br>Fibreboard (11G);<br>Wooden (11C, 11D and 11F);<br>Flexible (13H1, 13H2, 13H3, 13H4, 13H5, 13L1, 13L2, 13L3, 13L4, 13M1 or 13M2). |  |       |
| <b>Additional provisions:</b><br>Where the solid may become liquid during transport see 4.1.3.4.  |  |       |
| <b>Special packing provisions:</b>  |  |       |
| <b>B3</b>   | Flexible IBCs shall be sift-proof and water-resistant or shall be fitted with a sift-proof and water-resistant liner.  |       |
| <b>B4</b>   | Flexible, fibreboard or wooden IBCs shall be sift-proof and water-resistant or shall be fitted with a sift-proof and water-resistant liner.  |       |
| <b>B6</b>   | For UN Nos. 1327, 1363, 1364, 1365, 1386, 1408, 1841, 2211, 2217, 2793 and 3314, IBCs are not required to meet the IBC testing provisions of chapter 6.5.  |       |
| <b>B21</b>  | For solid substances in IBCs other than metal or rigid plastics IBCs, the IBCs shall be carried in closed cargo transport units or in freight containers/vehicles, which shall have rigid sides or fences at least to the height of the IBC. |       |

| IBC99  | PACKING INSTRUCTION | IBC99 |
|--|---------------------|-------|
| Only IBCs which are approved for these goods by the competent authority may be used (see 4.1.3.7). A copy of the competent authority approval shall accompany each consignment or the transport document shall include an indication that the packaging was approved by the competent authority. |                     |       |



Part 4 – Packing and tank provisions

| IBC100  | PACKING INSTRUCTION | IBC100 |
|---|---------------------|--------|
| This instruction applies to UN Nos. 0082, 0222, 0241, 0331 and 0332.  |                     |        |
| The following IBCs are authorized, provided the general provisions of 4.1.1, 4.1.2 and 4.1.3 and special provisions of 4.1.5 are met:<br>Metal (11A, 11B, 11N, 21A, 21B, 21N, 31A, 31B and 31N);<br>Flexible (13H2, 13H3, 13H4, 13L2, 13L3, 13L4 and 13M2);<br>Rigid plastics (11H1, 11H2, 21H1, 21H2, 31H1 and 31H2);<br>Composite (11HZ1, 11HZ2, 21HZ1, 21HZ2, 31HZ1 and 31HZ2).                                    |                     |        |
| <b>Additional provisions:</b>   |                     |        |
| 1 IBCs shall only be used for free-flowing substances.<br>2 Flexible IBCs shall only be used for solids.  |                     |        |
| <b>Special packing provisions:</b>  |                     |        |
| <b>B2</b> For UN 0222 in IBCs other than metal or rigid plastics IBCs, the IBCs shall be transported in closed cargo transport units.   |                     |        |
| <b>B3</b> For UN 0222, flexible IBCs shall be sift-proof and water resistant or shall be fitted with a sift-proof and water resistant liner.  |                     |        |
| <b>B9</b> For UN 0082, this packing instruction may only be used when the substances are mixtures of ammonium nitrate or other inorganic nitrates with other combustible substances which are not explosive ingredients. Such explosives shall not contain nitroglycerin, similar liquid organic nitrates, or chlorates. Metal IBCs are not authorized.   |                     |        |
| <b>B10</b> For UN 0241, this packing instruction may only be used for substances which consist of water as an essential ingredient and high proportions of ammonium nitrate or other oxidizing substances, some or all of which are in solution. The other constituents may include hydrocarbons or aluminium powder, but shall not include nitro-derivatives such as trinitrotoluene. Metal IBCs are not authorized. |                     |        |
| <b>B17</b> For UN 0222, metal IBCs are not authorized.  |                     |        |

| IBC520   | PACKING INSTRUCTION   | IBC520                       |                                  |                     |                       |
|--|---|------------------------------|----------------------------------|---------------------|-----------------------|
| This instruction applies to organic peroxides and self-reactive substances of type F.  |   |                              |                                  |                     |                       |
| △ The IBCs listed below are authorized for the formulations listed, provided the general provisions of 4.1.1, 4.1.2 and 4.1.3 and special provisions of 4.1.7.2 are met. The formulations not listed in 2.4.2.3.2.3 or 2.5.3.2.4 but listed below may also be transported packed in accordance with packing method OP8 of packing instruction P520 of 4.1.4.1, with the same control and emergency temperatures, if applicable.<br>For formulations not listed below, only IBCs which are approved by the competent authority may be used (see 4.1.7.2.2). |   |                              |                                  |                     |                       |
| UN No.   | Organic peroxide  | Type of IBC                  | Maximum quantity (litres)        | Control temperature | Emergency temperature |
| 3109   | <b>ORGANIC PEROXIDE TYPE F, LIQUID</b>  |                              |                                  |                     |                       |
|  | <i>tert</i> -Butyl cumyl peroxide   | 31HA1                        | 1,000                            |                     |                       |
|  | <i>tert</i> -Butyl hydroperoxide, not more than 72% with water                            | 31A<br>31HA1                 | 1,250<br>1,000                   |                     |                       |
|  | <i>tert</i> -Butyl peroxyacetate, not more than 32% in diluent type A                     | 31A<br>31HA1                 | 1,250<br>1,000                   |                     |                       |
|  | <i>tert</i> -Butyl peroxybenzoate, not more than 32% in diluent type A                    | 31A                          | 1,250                            |                     |                       |
|  | <i>tert</i> -Butyl peroxy-3,5,5-trimethylhexanoate, not more than 37% in diluent type A   | 31A<br>31HA1                 | 1,250<br>1,000                   |                     |                       |
|  | Cumyl hydroperoxide, not more than 90% in diluent type A                                  | 31HA1                        | 1,250                            |                     |                       |
|  | Dibenzoyl peroxide, not more than 42% as a stable dispersion                              | 31H1                         | 1,000                            |                     |                       |
|  | Di- <i>tert</i> -butyl peroxide, not more than 52% in diluent type A                      | 31A<br>31HA1                 | 1,250<br>1,000                   |                     |                       |
|  | 1,1-Di-( <i>tert</i> -butylperoxy)cyclohexane, not more than 37% in diluent type A        | 31A                          | 1,250                            |                     |                       |
|  | 1,1-Di-( <i>tert</i> -butylperoxy)cyclohexane, not more than 42% in diluent type A        | 31H1                         | 1,000                            |                     |                       |
|  | Dilauroyl peroxide, not more than 42%, stable dispersion, in water                        | 31HA1                        | 1,000                            |                     |                       |
|  | 2,5-Dimethyl-2,5-di( <i>tert</i> -butylperoxy)hexane, not more than 52% in diluent type A | 31HA1                        | 1,000                            |                     |                       |
|  | Isopropylcumyl hydroperoxide, not more than 72% in diluent type A                         | 31HA1                        | 1,250                            |                     |                       |
|  | <i>p</i> -Menthyl hydroperoxide, not more than 72% in diluent type A                      | 31HA1                        | 1,250                            |                     |                       |
|  | Peroxyacetic acid, stabilized, not more than 17%  | 31H1<br>31H2<br>31HA1<br>31A | 1,500<br>1,500<br>1,500<br>1,500 |                     |                       |



*Part 4 – Packing and tank provisions*

---

**Additional provisions:**

- 1 IBCs shall be provided with a device to allow venting during transport. The inlet to the pressure relief device shall be sited in the vapour space of the IBC under maximum filling conditions during transport.
- 2 To prevent explosive rupture of metal IBCs or composite IBCs with complete metal casing, the emergency relief devices shall be designed to vent all the decomposition products and vapours evolved during self-accelerating decomposition or during a period of not less than one hour of fire-engulfment as calculated by the formula in 4.2.1.13.8. The control and emergency temperatures specified in this packing instruction are based on a non-insulated IBC. When consigning an organic peroxide in an IBC in accordance with this instruction, it is the responsibility of the consignor to ensure that:
  - (a) the pressure and emergency relief devices installed on the IBC are designed to take appropriate account of the self-accelerating decomposition of the organic peroxide and of fire engulfment; and
  - (b) when applicable, the control and emergency temperatures indicated are appropriate, taking into account the design (such as insulation) of the IBC to be used.

Chapter 4.1 – Use of packagings, including IBCs and large packagings

| IBC620   | PACKING INSTRUCTION | IBC620 |
|--|---------------------|--------|
| This instruction applies to UN 3291.   |                     |        |
| The following IBCs are authorized, provided that the general provisions of 4.1.1, except 4.1.1.15, 4.1.2 and 4.1.3 are met:<br>Rigid, leakproof IBCs conforming to the packing group II performance level.   |                     |        |
| <p><b>Additional provisions:</b></p> <p>1 There shall be sufficient absorbent material to absorb the entire amount of liquid present in the IBC.</p> <p>2 IBCs shall be capable of retaining liquids.</p> <p>3 IBCs intended to contain sharp objects such as broken glass and needles shall be resistant to puncture.</p> |                     |        |

4.1.4.3 Packing instructions concerning the use of large packagings

| LP01   | PACKING INSTRUCTION (LIQUIDS)  |                 |                  |                   | LP01 |
|--|--|-----------------|------------------|-------------------|------|
| The following large packagings are authorized, provided the general provisions of 4.1.1 and 4.1.3 are met. |  |                 |                  |                   |      |
| Inner packagings   | Large outer packagings   | Packing group I | Packing group II | Packing group III |      |
| Glass 10 L<br>Plastics 30 L<br>Metal 40 L  | Steel (50A)<br>Aluminium (50B)<br>Metal other than steel or aluminium (50N)<br>Rigid plastics (50H)<br>Natural wood (50C)<br>Plywood (50D)<br>Reconstituted wood (50F)<br>Rigid fibreboard (50G) | Not allowed     | Not allowed      | 3 m <sup>3</sup>  |      |

| LP02  | PACKING INSTRUCTION (SOLIDS)   |                 |                  |                   | LP02 |
|---|--|-----------------|------------------|-------------------|------|
| The following large packagings are authorized, provided the general provisions of 4.1.1 and 4.1.3 are met.              |  |                 |                  |                   |      |
| Inner packagings  | Large outer packagings   | Packing group I | Packing group II | Packing group III |      |
| Glass 10 kg<br>Plastics <sup>b</sup> 50 kg<br>Metal 50 kg<br>Paper <sup>a, b</sup> 50 kg<br>Fibre <sup>a, b</sup> 50 kg | Steel (50A)<br>Aluminium (50B)<br>Metal other than steel or aluminium (50N)<br>Rigid plastics (50H)<br>Natural wood (50C)<br>Plywood (50D)<br>Reconstituted wood (50F)<br>Rigid fibreboard (50G)<br>Flexible plastics (51H) <sup>c</sup> | Not allowed     | Not allowed      | 3 m <sup>3</sup>  |      |

<sup>a</sup> These packagings shall not be used when the substances being transported may become liquid during transport.

<sup>b</sup> Packagings shall be sift-proof.

<sup>c</sup> To be used with flexible inner packagings only.

**Special packing provision:**

L2 Deleted

L3 For UN Nos.1309, 1376, 1483, 1869, 2793, 2858 and 2878, flexible or fibre inner packagings shall be sift-proof and water-resistant or shall be fitted with a sift-proof and water-resistant liner.

L4 For UN Nos.1932, 2008, 2009, 2545, 2546, 2881 and 3189 flexible or fibre inner packagings shall be hermetically sealed.





Part 4 – Packing and tank provisions

| LP03  | PACKING INSTRUCTION | LP03 |
|---|---------------------|------|
| This instruction applies to UN Nos. 3537, 3538, 3540, 3541, 3546, 3547 and 3548.  |                     |      |
| <p>(1) The following large packagings are authorized, provided that the general provisions of 4.1.1 and 4.1.3 are met:<br/>Rigid large packagings conforming to the packing group II performance level, made of:</p> <ul style="list-style-type: none"> <li>steel (50A);</li> <li>aluminium (50B);</li> <li>metal other than steel or aluminium (50N);</li> <li>rigid plastics (50H);</li> <li>natural wood (50C);</li> <li>plywood (50D);</li> <li>reconstituted wood (50F);</li> <li>rigid fibreboard (50G).</li> </ul> <p>(2) Additionally, the following conditions shall be met:</p> <ul style="list-style-type: none"> <li>(a) Receptacles within articles containing liquids or solids shall be constructed of suitable materials and secured in the article in such a way that, under normal conditions of transport, they cannot break, be punctured or leak their contents into the article itself or the outer packaging;</li> <li>(b) Receptacles containing liquids with closures shall be packed with their closures correctly oriented. The receptacles shall in addition conform to the internal pressure test provisions of 6.1.5.5;</li> <li>(c) Receptacles that are liable to break or be punctured easily, such as those made of glass, porcelain or stoneware or of certain plastics materials shall be properly secured. Any leakage of the contents shall not substantially impair the protective properties of the article or of the outer packaging;</li> <li>(d) Receptacles within articles containing gases shall meet the requirements of section 4.1.6 and chapter 6.2 as appropriate or be capable of providing an equivalent level of protection as packing instructions P200 or P208; and</li> <li>(e) Where there is no receptacle within the article, the article shall fully enclose the dangerous substances and prevent their release under normal conditions of transport.</li> </ul> <p>(3) Articles shall be packed to prevent movement and inadvertent operation during normal conditions of transport.</p> <p>■ (4) Articles containing pre-production prototype lithium cells or batteries when these prototypes are transported for testing or production runs of not more than 100 lithium cells or batteries that are of a type that have not met the testing requirements of the Manual of Tests and Criteria, part III, subsection 38.3 shall in addition meet the following:</p> <ul style="list-style-type: none"> <li>(a) Packagings shall conform to the requirements in paragraph (1) of this packing instruction.</li> <li>(b) Appropriate measures shall be taken to minimize the effects of vibration and shocks and prevent movement of the article within the package that may lead to damage and a dangerous condition during transport. When cushioning material is used to meet this requirement it shall be non-combustible and electrically non-conductive.</li> <li>(c) Non-combustibility of the cushioning material shall be assessed according to a standard recognized in the country where the packaging is designed or manufactured.</li> </ul> |                     |      |
| LP99  | PACKING INSTRUCTION | LP99 |
| Only large packagings which are approved for these goods by the competent authority may be used (see 4.1.3.7). A copy of the competent authority approval shall accompany each consignment or the transport document shall include an indication that the packaging was approved by the competent authority.  |                     |      |



Chapter 4.1 – Use of packagings, including IBCs and large packagings

| LP101 PACKING INSTRUCTION LP101   |                         |  |
|---|-------------------------|--|
| The following large packagings are authorized, provided the general provisions of 4.1.1 and 4.1.3 and special provisions of 4.1.5 are met.  |                         |  |
| Inner packagings  | Intermediate packagings | Large packagings   |
| <i>Not necessary</i>  | <i>Not necessary</i>    | Steel (50A)<br>Aluminium (50B)<br>Metal other than steel or aluminium (50N)<br>Rigid plastics (50H)<br>Natural wood (50C)<br>Plywood (50D)<br>Reconstituted wood (50F)<br>Rigid fibreboard (50G) |
| <b>Special packing provision:</b>   |                         |  |
| <p><b>L1</b> For UN Nos. 0006, 0009, 0010, 0015, 0016, 0018, 0019, 0034, 0035, 0038, 0039, 0048, 0056, 0137, 0138, 0168, 0169, 0171, 0181, 0182, 0183, 0186, 0221, 0243, 0244, 0245, 0246, 0254, 0280, 0281, 0286, 0287, 0297, 0299, 0300, 0301, 0303, 0321, 0328, 0329, 0344, 0345, 0346, 0347, 0362, 0363, 0370, 0412, 0424, 0425, 0434, 0435, 0436, 0437, 0438, 0451, 0488, 0502 and 0510: Large and robust explosives articles, normally intended for military use, without their means of initiation or with their means of initiation containing at least two effective protective features, may be transported unpackaged. When such articles have propelling charges or are self-propelled, their ignition systems shall be protected against stimuli encountered during normal conditions of transport. A negative result in Test Series 4 on an unpackaged article indicates that the article can be considered for transport unpackaged. Such unpackaged articles may be fixed to cradles or contained in crates or other suitable handling devices.</p> |                         |  |

| LP102 PACKING INSTRUCTION LP102  |                         |  |
|--|-------------------------|--|
| The following large packagings are authorized, provided the general provisions of 4.1.1 and 4.1.3 and special provisions of 4.1.5 are met.   |                         |  |
| Inner packagings   | Intermediate packagings | Outer packagings   |
| <b>Bags</b><br>water-resistant<br><br><b>Receptacles</b><br>fibreboard<br>metal<br>plastics<br>wood<br><br><b>Sheets</b><br>fibreboard, corrugated<br><br><b>Tubes</b><br>fibreboard | <i>Not necessary</i>    | Steel (50A)<br>Aluminium (50B)<br>Metal other than steel or aluminium (50N)<br>Rigid plastics (50H)<br>Natural wood (50C)<br>Plywood (50D)<br>Reconstituted wood (50F)<br>Rigid fibreboard (50G) |

| LP200 PACKING INSTRUCTION LP200  |  |
|--|--|
| This instruction applies to UN 1950 and UN 2037.   |  |
| The following large packagings are authorized for aerosols and gas cartridges, provided that the general provisions of 4.1.1 and 4.1.3 are met:  |  |
| Rigid large packagings conforming to the packing group II performance level, made of:  |  |
| steel (50A);<br>aluminium (50B);<br>metal other than steel or aluminium (50N);<br>rigid plastics (50H);<br>natural wood (50C);<br>plywood (50D);<br>reconstituted wood (50F);<br>rigid fibreboard (50G).   |  |
| <b>Special packing provision:</b>  |  |
| <p><b>L2</b> The large packagings shall be designed and constructed to prevent dangerous movement and inadvertent discharge during normal conditions of transport. For waste aerosols transported in accordance with special provision 327, the large packagings shall have a means of retaining any free liquid that might escape during transport, e.g. absorbent material. For waste aerosols and waste gas cartridges carried in accordance with special provision 327, the large packagings shall be adequately ventilated to prevent the creation of dangerous atmospheres and the build-up of pressure.</p> |  |



Part 4 – Packing and tank provisions

| LP621  | PACKING INSTRUCTION | LP621 |
|--|---------------------|-------|
| This instruction applies to UN 3291.   |                     |       |
| The following large packagings are authorized, provided the general provisions of 4.1.1 and 4.1.3 are met:   |                     |       |
| <ol style="list-style-type: none"> <li>(1) For clinical waste placed in inner packagings: Rigid, leakproof large packagings conforming to the provisions of chapter 6.6 for solids, at the packing group II performance level, provided there is sufficient absorbent material to absorb the entire amount of liquid present and the large packaging is capable of retaining liquids.</li> <li>(2) For packages containing larger quantities of liquid: Large rigid packagings conforming to the provisions of chapter 6.6, at the packing group II performance level, for liquids.</li> </ol> |                     |       |
| <b>Additional provision:</b>   |                     |       |
| Large packagings intended to contain sharp objects such as broken glass and needles shall be resistant to puncture and retain liquids under the performance test conditions in chapter 6.6.  |                     |       |

| LP622   | PACKING INSTRUCTION     | LP622  |
|---|-------------------------|--|
| This instruction applies to waste of UN 3549 transported for disposal.  |                         |  |
| The following large packagings are authorized provided the general provisions of 4.1.1 and 4.1.3 are met:   |                         |  |
| Inner packagings  | Intermediate packagings | Outer packagings   |
| metal<br>plastics   | metal<br>plastics       | Steel (50A)<br>Aluminium (50B)<br>Metal other than steel or aluminium (50N)<br>Plywood (50D)<br>Rigid fibreboard (50G)<br>Rigid plastics (50H) |
| The outer packaging shall conform to the packing group I performance level for solids.  |                         |  |
| <b>Additional requirement:</b>  |                         |  |
| <ol style="list-style-type: none"> <li>1. Fragile articles shall be contained in either a rigid inner packaging or a rigid intermediate packaging.</li> <li>2. Inner packagings containing sharp objects such as broken glass and needles shall be rigid and resistant to puncture.</li> <li>3. The inner packaging, the intermediate packaging and the outer packaging shall be capable of retaining liquids. Outer packagings that are not capable of retaining liquids by design shall be fitted with a liner or suitable measure of retaining liquids.</li> <li>4. The inner packaging and/or the intermediate packaging may be flexible. When flexible packagings are used, they shall be capable of passing the impact resistance test of at least 165 g according to ISO 7765-1:1988 "Plastics film and sheeting – Determination of impact resistance by the free-falling dart method – Part 1: Staircase methods" and the tear resistance test of at least 480 g in both parallel and perpendicular planes with respect to the length of the bag in accordance with ISO 6383-2:1983 <i>Plastics – Film and sheeting – Determination of tear resistance – Part 2: Elmendorf method</i>. The maximum net mass of each flexible inner packaging shall be 30 kg.</li> <li>5. Each flexible intermediate packaging shall contain only one inner packaging.</li> <li>6. Inner packagings containing a small amount of free liquid may be included in intermediate packaging provided that there is sufficient absorbent or solidifying material in the inner or intermediate packaging to absorb or solidify all the liquid content present. Suitable absorbent material which withstands the temperatures and vibrations liable to occur under normal conditions of transport shall be used.</li> <li>7. Intermediate packagings shall be secured in outer packagings with suitable cushioning and/or absorbent material.</li> </ol> |                         |  |



Chapter 4.1 – Use of packagings, including IBCs and large packagings

| LP902   | PACKING INSTRUCTION  | LP902 |
|---|--|-------|
| This instruction applies to UN 3268.  |  |       |
| △   | <p>(1) Packaged articles:<br/>The following large packagings are authorized, provided the general provisions of 4.1.1 and 4.1.3 are met:<br/>Rigid large packagings conforming to the packing group III performance level, made of:</p> <ul style="list-style-type: none"> <li>steel (50A);</li> <li>aluminium (50B);</li> <li>metal other than steel or aluminium (50N);</li> <li>rigid plastics (50H);</li> <li>natural wood (50C);</li> <li>plywood (50D);</li> <li>reconstituted wood (50F);</li> <li>rigid fibreboard (50G).</li> </ul> <p>The packagings shall be designed and constructed to prevent movement of the articles and inadvertent operation during normal conditions of transport.</p>  |       |
| △   | <p>(2) Unpackaged articles:<br/>The articles may also be transported unpackaged in dedicated handling devices, vehicles, containers or wagons when moved to, from, or between where they are manufactured and an assembly plant including intermediate handling locations.</p>   |       |
| <p><b>Additional provision:</b><br/>Any pressure receptacle shall be in accordance with the requirements of the competent authority for the substance(s) contained in the pressure receptacle(s).</p> |  |       |
| LP903   | PACKING INSTRUCTION  | LP903 |
| △   | This instruction applies to large cells with a gross mass of more than 500 g, large batteries with a gross mass of more than 12 kg, and equipment containing large cells or large batteries of UN Nos. 3090, 3091, 3480, 3481, 3551 and 3552.  |       |
| △   | <p>The following large packagings are authorized for cells, batteries and equipment containing cells or batteries, provided that the general provisions of 4.1.1 and 4.1.3 are met:<br/>Rigid large packagings conforming to the packing group II performance level, made of:</p> <ul style="list-style-type: none"> <li>steel (50A);</li> <li>aluminium (50B);</li> <li>metal other than steel or aluminium (50N);</li> <li>rigid plastics (50H);</li> <li>natural wood (50C);</li> <li>plywood (50D);</li> <li>reconstituted wood (50F);</li> <li>rigid fibreboard (50G).</li> </ul>   |       |
| △   | <p>Cells, batteries or equipment shall be placed in inner packagings or separated by other suitable means, such as placement in trays or by dividers, to ensure protection against damage that may be caused under normal conditions of transport by:</p> <ul style="list-style-type: none"> <li>(a) its movement or placement within the large packaging;</li> <li>(b) contact with other cells, batteries or equipment within the large packaging; and</li> <li>(c) any loads arising from the superimposed weight of cells, batteries, equipment and packaging components above the cell, battery or equipment within the large packaging.</li> </ul> <p>When multiple cells, batteries or items of equipment, are packed in the large packaging, bags (e.g. plastics) alone shall not be used to satisfy these requirements.</p> |       |
| <p><b>Additional requirement:</b><br/>Batteries shall be protected against short circuit.</p>   |  |       |



Part 4 – Packing and tank provisions

| LP904 | PACKING INSTRUCTION  | LP904 |
|-------|--|-------|
| △     | <p>This instruction applies to single damaged or defective batteries and to single items of equipment containing damaged or defective cells or batteries of UN Nos. 3090, 3091, 3480, 3481, 3551 and 3552.</p> <p>The following large packagings are authorized for a single damaged or defective battery and for a single item of equipment containing damaged or defective cells or batteries, provided the general provisions of 4.1.1 and 4.1.3 are met.</p> <p>For batteries and equipment containing cells and batteries:<br/>Rigid large packagings conforming to the packing group II performance level, made of:</p> <ul style="list-style-type: none"> <li>steel (50A)</li> <li>aluminium (50B)</li> <li>metal other than steel or aluminium (50N)</li> <li>rigid plastics (50H)</li> <li>plywood (50D)</li> </ul> <p>■ Large packagings shall also meet the following requirements:</p> <ul style="list-style-type: none"> <li>(a) The damaged or defective battery or equipment containing such cells or batteries shall be individually packed in an inner packaging and placed inside of an outer packaging. The inner packaging or outer packaging shall be leakproof to prevent the potential release of electrolyte.</li> <li>(b) The inner packaging shall be surrounded by sufficient non-combustible and electrically non-conductive thermal insulation material to protect against a dangerous evolution of heat.</li> <li>(c) Sealed packagings shall be fitted with a venting device when appropriate.</li> <li>(d) Appropriate measures shall be taken to minimize the effects of vibrations and shocks, prevent movement of the battery or the equipment within the package that may lead to further damage and a dangerous condition during transport. Cushioning material that is non-combustible and electrically non-conductive may also be used to meet this requirement.</li> </ul> |       |
| △     | <ul style="list-style-type: none"> <li>(e) The non-combustibility of the thermal insulation material and the cushioning material shall be assessed according to a standard recognized in the country where the packaging is designed or manufactured.</li> </ul> <p>For leaking batteries and cells, sufficient inert absorbent material shall be added to the inner or outer packaging to absorb any release of electrolyte.</p> <p><b>Additional requirement:</b><br/>Batteries and cells shall be protected against short circuit.</p>  |       |



Chapter 4.1 – Use of packagings, including IBCs and large packagings

| LP905 | PACKING INSTRUCTION  | LP905 |
|-------|--|-------|
| △     | <p>This instruction applies to UN Nos. 3090, 3091, 3480, 3481, 3551 and 3552 production runs consisting of not more than 100 cells or batteries and to pre-production prototypes of cells or batteries when these prototypes are transported for testing.</p> <p>The following large packagings are authorized for a single battery and for a single item of equipment containing cells or batteries, provided that the general provisions of 4.1.1 and 4.1.3 are met:</p> <p>(1) For a single battery:<br/>Rigid large packagings conforming to the packing group II performance level, made of:<br/>steel (50A);<br/>aluminium (50B);<br/>metal other than steel or aluminium (50N);<br/>rigid plastics (50H);<br/>natural wood (50C);<br/>plywood (50D);<br/>reconstituted wood (50F);<br/>rigid fibreboard (50G).</p> <p>Large packagings shall also meet the following requirements:</p> <p>(a) A battery of different size, shape or mass may be packed in an outer packaging of a tested design type listed above provided the total gross mass of the package does not exceed the gross mass for which the design type has been tested;</p> <p>(b) The battery shall be packed in an inner packaging and placed inside the outer packaging;</p> <p>(c) The inner packaging shall be completely surrounded by sufficient non-combustible and electrically non-conductive thermal insulation material to protect against a dangerous evolution of heat;</p> <p>(d) Appropriate measures shall be taken to minimize the effects of vibration and shocks and prevent movement of the battery within the package that may lead to damage and a dangerous condition during transport. When cushioning material is used to meet this requirement it shall be non-combustible and electrically non-conductive; and</p> |       |
| △     | <p>(e) The non-combustibility of the thermal insulation material and the cushioning material shall be assessed according to a standard recognized in the country where the large packaging is designed or manufactured.</p> <p>(2) For a single item of equipment containing cells or batteries:<br/>Rigid large packagings conforming to the packing group II performance level, made of:<br/>steel (50A);<br/>aluminium (50B);<br/>metal other than steel or aluminium (50N);<br/>rigid plastics (50H);<br/>natural wood (50C);<br/>plywood (50D);<br/>reconstituted wood (50F);<br/>rigid fibreboard (50G).</p> <p>Large packagings shall also meet the following requirements:</p> <p>(a) A single item of equipment of different size, shape or mass may be packed in an outer packaging of a tested design type listed above provided the total gross mass of the package does not exceed the gross mass for which the design type has been tested;</p> <p>(b) The equipment shall be constructed or packed in such a manner as to prevent accidental operation during transport;</p> <p>(c) Appropriate measures shall be taken to minimize the effects of vibration and shocks and prevent movement of the equipment within the package that may lead to damage and a dangerous condition during transport. When cushioning material is used to meet this requirement, it shall be non-combustible and electrically non-conductive; and</p>  |       |
| △     | <p>(d) The non-combustibility of the cushioning material shall be assessed according to a standard recognized in the country where the large packaging is designed or manufactured.</p> <p><b>Additional requirement:</b><br/>Cells and batteries shall be protected against short circuit.</p>  |       |



Part 4 – Packing and tank provisions

|   | PACKING INSTRUCTION   | LP906 |
|---|---|-------|
| △ | <p>This instruction applies to damaged or defective batteries of UN Nos. 3090, 3091, 3480, 3481, 3551 and 3552 liable to rapidly disassemble, dangerously react, produce a flame or a dangerous evolution of heat or a dangerous emission of toxic, corrosive or flammable gases or vapours under normal conditions of transport.</p> <p>The following large packagings are authorized, provided that the general provisions of 4.1.1 and 4.1.3 are met:<br/>For batteries and items of equipment containing batteries:<br/>Rigid large packagings conforming to the packing group I performance level, made of:</p> <ul style="list-style-type: none"> <li>steel (50A);</li> <li>aluminium (50B);</li> <li>metal other than steel or aluminium (50N);</li> <li>rigid plastics (50H);</li> <li>plywood (50D);</li> <li>rigid fibreboard (50G).</li> </ul> <p>(1) The large packaging shall be capable of meeting the following additional performance requirements in case of rapid disassembly, dangerous reaction, production of a flame or a dangerous evolution of heat or a dangerous emission of toxic, corrosive or flammable gases or vapours of the battery:</p> <ul style="list-style-type: none"> <li>(a) The outside surface temperature of the completed package shall not have a temperature of more than 100°C. A momentary spike in temperature up to 200°C is acceptable;</li> <li>(b) No flame shall occur outside the package;</li> <li>(c) No projectiles shall exit the package;</li> <li>(d) The structural integrity of the package shall be maintained; and</li> <li>(e) The large packagings shall have a gas management system (e.g. filter system, air circulation, containment for gas, gas tight packaging etc.), as appropriate.</li> </ul> <p>(2) The additional large packaging performance requirements shall be verified by a test as specified by the competent authority.*</p> <p>A verification report shall be made available on request. As a minimum requirement, the name of the batteries, their type as defined in section 38.3.2.3 of the <i>Manual of Tests and Criteria</i>, the maximum number of batteries, the total mass of batteries, the total energy content of the batteries, the large packaging identification and the test data according to the verification method as specified by the competent authority shall be listed in the verification report. A set of specific instructions describing the way to use the package shall also be part of the verification report.</p> <p>(3) When dry ice or liquid nitrogen is used as a coolant, the requirements of section 5.5.3 shall apply. The inner packaging and outer packaging shall maintain their integrity at the temperature of the refrigerant used as well as the temperatures and the pressures which could result if refrigeration were lost.</p> <p>(4) The specific instructions for use of the package shall be made available by the packaging manufacturers and subsequent distributors to the consignor. They shall include at least the identification of the batteries and items of equipment that may be contained inside the packaging, the maximum number of batteries contained in the package and the maximum total of the batteries' energy content, as well as the configuration inside the package, including the separations and protections used during the performance verification test.</p> | LP906 |
|   | <p><b>Additional requirement:</b><br/>Batteries shall be protected against short circuit.</p>   |       |
| △ | <p>* The following criteria, as relevant, may be considered to assess the performance of the large packaging:</p> <ul style="list-style-type: none"> <li>(a) The assessment shall be done under a quality management system (as described, e.g. in section 2.9.4.5) allowing for the traceability of tests results, reference data and characterization models used;</li> <li>(b) The list of hazards expected in case of thermal runaway for the battery type, in the condition it is transported (e.g. usage of an inner packaging, state of charge (SOC), use of sufficient non-combustible, electrically non-conductive and absorbent cushioning material etc.), shall be clearly identified and quantified; the reference list of possible hazards for batteries (e.g. rapidly disassemble, dangerously react, produce a flame or a dangerous evolution of heat or a dangerous emission of toxic, corrosive or flammable gases or vapours) can be used for this purpose. The quantification of these hazards shall rely on available scientific literature;</li> <li>(c) The mitigating effects of the large packaging shall be identified and characterized, based on the nature of the protections provided and the construction material properties. A list of technical characteristics and drawings shall be used to support this assessment (density [kg·m<sup>-3</sup>], specific heat capacity [J·kg<sup>-1</sup>·K<sup>-1</sup>], heating value [kJ·kg<sup>-1</sup>], thermal conductivity [W·m<sup>-1</sup>·K<sup>-1</sup>], melting temperature and flammability temperature [K], heat transfer coefficient of the outer packaging [W·m<sup>-2</sup>·K<sup>-1</sup>], ...);</li> <li>(d) The test and any supporting calculations shall assess the result of a thermal run-away of the battery inside the large packaging in the normal conditions of transport;</li> <li>(e) In case the SOC of the battery is not known, the assessment used shall be done with the highest possible SOC corresponding to the battery use conditions;</li> <li>(f) The surrounding conditions in which the large packaging may be used and transported shall be described (including for possible consequences of gas or smoke emissions on the environment, such as ventilation or other methods) according to the gas management system of the large packaging;</li> <li>(g) The tests or the model calculation shall consider the worst case scenario for the thermal runaway triggering and propagation inside the battery: this scenario includes the worst possible failure in the normal transport condition, the maximum heat and flame emissions for the possible propagation of the reaction;</li> <li>(h) These scenarios shall be assessed over a period long enough to allow all the possible consequences to occur (e.g. 24 hours).</li> <li>(i) In the case of multiple batteries and multiple items of equipment containing batteries, additional requirements such as the maximum number of batteries and items of equipment, the total maximum energy content of the batteries, and the configuration inside the package, including separations and protections of the parts, shall be considered.</li> </ul>   |       |





## 4.1.5 Special packing provisions for goods of class 1

- 4.1.5.1 The general provisions of 4.1.1 shall be met.
- 4.1.5.2 All packagings for class 1 goods shall be so designed and constructed that:
- .1 they will protect the explosives, prevent them escaping and cause no increase in the risk of unintended ignition or initiation when subjected to normal conditions of transport, including foreseeable changes in temperature, humidity and pressure;
  - .2 the complete package can be handled safely in normal conditions of transport; and
  - .3 the packages will withstand any loading imposed on them by foreseeable stacking to which they will be subject during transport so that they do not add to the risk presented by the explosives, the containment function of the packagings is not harmed, and they are not distorted in a way or to an extent which will reduce their strength or cause instability of a stack.
- 4.1.5.3 All explosive substances and articles, as prepared for transport, shall have been classified in accordance with the procedures detailed in 2.1.3.
- 4.1.5.4 Class 1 goods shall be packed in accordance with the appropriate packing instruction shown in columns 8 and 9 of the Dangerous Goods List, as detailed in 4.1.4.
- 4.1.5.5 Unless otherwise specified in this Code, packagings, including IBCs and large packagings, shall conform to the requirements of chapters 6.1, 6.5 or 6.6, as appropriate, and shall meet their test provisions for packing group II.
- 4.1.5.6 The closure device of packagings containing liquid explosives shall ensure a double protection against leakage.
- 4.1.5.7 The closure device of metal drums shall include a suitable gasket; if a closure device includes a screw-thread, the ingress of explosive substances into the screw-thread shall be prevented.
- 4.1.5.8 Packagings for water-soluble substances shall be water-resistant. Packagings for desensitized or phlegmatized substances shall be closed to prevent changes in concentration during transport.
- 4.1.5.9 When the packaging includes a double envelope filled with water which may freeze during transport, a sufficient quantity of an anti-freeze agent shall be added to the water to prevent freezing. Anti-freeze that could create a fire hazard because of its inherent flammability shall not be used.
- 4.1.5.10 Nails, staples and other closure devices made of metal without protective covering shall not penetrate to the inside of the outer packaging unless the inner packaging adequately protects the explosives against contact with the metal.
- 4.1.5.11 Inner packagings, fittings and cushioning materials and the placing of explosive substances or articles in packages shall be accomplished in a manner which prevents the explosive substances or articles from becoming loose in the outer packaging under normal conditions of transport. Metallic components of articles shall be prevented from making contact with metal packagings. Articles containing explosive substances not enclosed in an outer casing shall be separated from each other in order to prevent friction and impact. Padding, trays, partitioning in the inner or outer packaging, mouldings or receptacles may be used for this purpose.
- 4.1.5.12 Packagings shall be made of materials compatible with, and impermeable to, the explosives contained in the package, so that neither interaction between the explosives and the packaging materials nor leakage causes the explosive to become unsafe to transport, or the hazard division or compatibility group to change.
- 4.1.5.13 The ingress of explosive substances into the recesses of seamed metal packagings shall be prevented.
- 4.1.5.14 Plastics packagings shall not be liable to generate or accumulate sufficient static electricity so that a discharge could cause the packaged explosive substances or articles to initiate, ignite or function.
- 4.1.5.15 Large and robust explosives articles, normally intended for military use, without their means of initiation or with their means of initiation containing at least two effective protective features may be transported unpackaged. When such articles have propelling charges or are self-propelled, their ignition systems shall be protected against stimuli encountered during normal conditions of transport. A negative result in Test Series 4 on an unpackaged article indicates that the article can be considered for transport unpackaged. Such unpackaged articles may be fixed to cradles or contained in crates or other suitable handling, storage or launching devices in such a way that they will not become loose during normal conditions of transport. Where such large explosive articles are, as part of their operational safety and suitability tests, subjected to test regimes that meet the provisions of this Code and such tests have been successfully undertaken, the competent authority may approve such articles to be transported under this Code.
- 4.1.5.16 Explosive substances shall not be packed in inner or outer packagings where the differences in internal and external pressures, due to thermal or other effects, could cause an explosion or rupture of the package.



**Part 4 – Packing and tank provisions**

- 4.1.5.17 Whenever loose explosive substances or the explosive substance of an uncased or partly cased article may come into contact with the inner surface of metal packagings (1A1, 1A2, 1B1, 1B2, 4A, 4B and metal receptacles), the metal packaging shall be provided with an inner liner or coating (see 4.1.1.2).
- 4.1.5.18 Packing instruction P101 may be used for any explosive provided the package has been approved by a competent authority regardless of whether the packaging complies with the packing instruction assignment in the Dangerous Goods List.
- 4.1.5.19 Government-owned military dangerous goods, packaged prior to 1 January 1990 in accordance with the provisions of the IMDG Code in effect at that time, may be transported provided the packagings maintain their integrity and the goods are declared as government-owned goods packaged prior to 1 January 1990.

**4.1.6 Special packing provisions for goods of class 2****4.1.6.1 General provisions**

- 4.1.6.1.1 This section provides general requirements applicable to the use of pressure receptacles for the transport of class 2 gases and other dangerous goods in pressure receptacles (e.g. UN 1051 Hydrogen cyanide, stabilized). Pressure receptacles shall be constructed and closed so as to prevent any loss of contents which might be caused under normal conditions of transport, including by vibration, or by changes in temperature, humidity or pressure (resulting from change in altitude, for example).
- △ 4.1.6.1.2 Parts of pressure receptacles which are in direct contact with dangerous goods shall not be affected or weakened by those dangerous goods and shall not cause a dangerous effect (e.g. catalysing a reaction or reacting with the dangerous goods). The provisions of ISO 11114-1:2020 and ISO 11114-2:2021 shall be met as applicable.
- 4.1.6.1.3 Pressure receptacles, including their closures, shall be selected to contain a gas or a mixture of gases according to the requirements of 6.2.1.2 and the requirements of the specific packing instructions of 4.1.4.1. This section also applies to pressure receptacles which are elements of MEGCs.
- 4.1.6.1.4 Refillable pressure receptacles shall not be filled with a gas or gas mixture different from that previously contained unless the necessary operations for change of gas service have been performed. The change of service for compressed and liquefied gases shall be in accordance with ISO 11621:1997, as applicable. In addition, a pressure receptacle that previously contained a class 8 corrosive substance or a substance of another class with a corrosive subsidiary hazard shall not be authorized for the transport of a class 2 substance unless the necessary inspection and testing as specified in 6.2.1.6 have been performed.
- 4.1.6.1.5 Prior to filling, the filler shall perform an inspection of the pressure receptacle and ensure that the pressure receptacle is authorized for the gas and, in case of a chemical under pressure, for the propellant to be transported and that the provisions of this Code have been met. Shut-off valves shall be closed after filling and remain closed during transport. The consignor shall verify that the closures and equipment are not leaking.
- 4.1.6.1.6 Pressure receptacles shall be filled according to the working pressures, filling ratios and provisions specified in the appropriate packing instruction for the specific substance being filled and taking into account the lowest design pressure of any component. Service equipment having a design pressure lower than other components shall nevertheless comply with 6.2.1.3.1. Reactive gases and gas mixtures shall be filled to a pressure such that if complete decomposition of the gas occurs, the working pressure of the pressure receptacle shall not be exceeded.
- 4.1.6.1.7 Pressure receptacles, including their closures, shall conform to the design, construction, inspection and testing requirements detailed in chapter 6.2. When outer packagings are prescribed, the pressure receptacles shall be firmly secured therein. Unless otherwise specified in the detailed packing instructions, one or more inner packagings may be enclosed in an outer packaging.
- 4.1.6.1.8 Valves shall be designed and constructed in such a way that they are inherently able to withstand damage without release of the contents or shall be protected from damage which could cause inadvertent release of the contents of the pressure receptacle, by one of the following methods:
- .1 Valves are placed inside the neck of the pressure receptacle and protected by a threaded plug or cap;
  - △ .2 Valves are protected by caps or guards. Caps shall possess vent-holes of sufficient cross-sectional area to evacuate the gas if leakage occurs at the valves;
  - .3 Valves are protected by shrouds or permanent protective attachments;
  - .4 Pressure receptacles are transported in frames (e.g. bundles); or
  - .5 Pressure receptacles are transported in an outer packaging. The packaging as prepared for transport shall be capable of meeting the drop test specified in 6.1.5.3 at the packing group I performance level.
- △ For pressure receptacles with valves as described in .2, the requirements of ISO 11117:1998, ISO 11117:2008 + Cor 1:2009 or ISO 11117:2019 shall be met. Requirements for shrouds and permanent protective attachments used as valve protection under .3, are given in the relevant pressure receptacle shell design standards, see 6.2.2.1. Valves with inherent protection used for refillable pressure receptacles shall meet the requirements of clause 4.6.2 of ISO 10297:2006 or clause 5.5.2 of ISO 10297:2014 or clause 5.5.2 of ISO

10297:2014 + Amd 1:2017, or in case of self-closing valves, of clause 5.4.2 of ISO 17879:2017. For valves with inherent protection used for non-refillable cylinders, the requirements of clause 9.2.5 of ISO 11118:2015 or of clause 9.2.5 of ISO 11118:2015 + Amd 1:2019 shall be met.

For metal hydride storage systems, the valve protection requirements specified in ISO 16111:2008 or ISO 16111:2018 shall be met.

- 4.1.6.1.9** Non-refillable pressure receptacles shall:
- .1 be transported in an outer packaging, such as a box, or crate, or in shrink-wrapped trays or stretch-wrapped trays;
  - .2 be of a water capacity less than or equal to 1.25 L when filled with flammable or toxic gas;
  - .3 not be used for toxic gases with an  $LC_{50}$  less than or equal to 200 mL/m<sup>3</sup>; and
  - .4 not be repaired after being put into service.
- 4.1.6.1.10** Refillable pressure receptacles, other than closed cryogenic receptacles, shall be periodically inspected in accordance with 6.2.1.6 and packing instruction P200, P205, P206 or P208, as applicable. Pressure relief valves for closed cryogenic receptacles shall be subject to periodic inspections and tests according to the provisions of 6.2.1.6.3 and packing instruction P203. Pressure receptacles shall not be filled after they become due for periodic inspection but may be transported after the expiry of the time limit.
- 4.1.6.1.11** Repairs shall be consistent with the manufacture and testing requirements of the applicable design and construction standards and are only permitted as indicated in the relevant periodic inspection standards specified in 6.2.2.4. Pressure receptacles, other than the jacket of closed cryogenic receptacles, shall not be subjected to repairs of any of the following:
- .1 weld cracks or other weld defects;
  - .2 cracks in walls;
  - .3 leaks or defects in the material of the wall, head or bottom.
- 4.1.6.1.12** Pressure receptacles shall not be offered for filling:
- .1 when damaged to such an extent that the integrity of the pressure receptacle or its service equipment may be affected;
  - .2 unless the pressure receptacle and its service equipment has been examined and found to be in good working order; or
  - .3 unless the required certification, retest, and filling marks are legible.
- 4.1.6.1.13** Filled pressure receptacles shall not be offered for transport:
- .1 when leaking;
  - .2 when damaged to such an extent that the integrity of the pressure receptacle or its service equipment may be affected;
  - .3 unless the pressure receptacle and its service equipment has been examined and found to be in good working order; or
  - .4 unless the required certification, retest, and filling marks are legible.
- 4.1.6.1.14** Where in packing instruction P200 cylinders and other pressure receptacles for gases conforming to the requirements of this subsection and chapter 6.2 are authorized, use is also authorized of cylinders and pressure receptacles which conform to the requirements of the competent authority of the country in which the cylinder or pressure receptacle is filled. Valves shall be suitably protected. Pressure receptacles with capacities of 1 L or less shall be packed in outer packagings constructed of suitable material of adequate strength and design in relation to the capacity of the packaging and its intended use and secured or cushioned so as to prevent significant movement within the outer packaging during normal conditions of transport.

#### **4.1.7 Special packing provisions for organic peroxides (class 5.2) and self-reactive substances of class 4.1**

##### **4.1.7.0 General**

- 4.1.7.0.1** For organic peroxides, all receptacles shall be “effectively closed”. Where significant internal pressure may develop in a package by the evolution of gas, a vent may be fitted, provided the gas emitted will not cause danger, otherwise the degree of filling shall be limited. Any venting device shall be so constructed that liquid will not escape when the package is in an upright position and it shall be able to prevent ingress of impurities. The outer packaging, if any, shall be so designed as not to interfere with the operation of the venting device.

**Part 4 – Packing and tank provisions****4.1.7.1 Use of packagings (except IBCs)**

4.1.7.1.1 Packagings for organic peroxides and self-reactive substances shall conform to the provisions of chapter 6.1 and shall meet its test provisions for packing group II.

4.1.7.1.2 The packing methods for organic peroxides and self-reactive substances are listed in packing instruction P520 and are designated OP1 to OP8. The quantities specified for each packing method are the maximum quantities authorized per package.

4.1.7.1.3 The packing methods appropriate for the individual currently assigned self-reactive substances and organic peroxides are listed in 2.4.2.3.2.3 and 2.5.3.2.4.

4.1.7.1.4 For new organic peroxides, new self-reactive substances or new formulations of currently assigned organic peroxides or self-reactive substances, the following procedure shall be used to assign the appropriate packing method:

- .1 **ORGANIC PEROXIDE TYPE B or SELF-REACTIVE SUBSTANCE TYPE B:**  
Packing method OP5 shall be assigned, provided that the organic peroxide (or self-reactive substance) satisfies the criteria of 2.5.3.3.2.2 (resp. 2.4.2.3.3.2.2) in a packaging authorized by the packing method. If the organic peroxide (or self-reactive substance) can only satisfy these criteria in a smaller packaging than those authorized by packing method OP5 (viz. one of the packagings listed for OP1 to OP4), then the corresponding packing method with the lower OP number is assigned;
- .2 **ORGANIC PEROXIDE TYPE C or SELF-REACTIVE SUBSTANCE TYPE C:**  
Packing method OP6 shall be assigned, provided that the organic peroxide (or self-reactive substance) satisfies the criteria of 2.5.3.3.2.3 (resp. 2.4.2.3.3.2.3) in packaging authorized by the packing method. If the organic peroxide (or self-reactive substance) can only satisfy these criteria in a smaller packaging than those authorized by packing method OP6, then the corresponding packing method with the lower OP number is assigned;
- .3 **ORGANIC PEROXIDE TYPE D or SELF-REACTIVE SUBSTANCE TYPE D:**  
Packing method OP7 shall be assigned to this type of organic peroxide or self-reactive substance;
- .4 **ORGANIC PEROXIDE TYPE E or SELF-REACTIVE SUBSTANCE TYPE E:**  
Packing method OP8 shall be assigned to this type of organic peroxide or self-reactive substance;
- .5 **ORGANIC PEROXIDE TYPE F or SELF-REACTIVE SUBSTANCE TYPE F:**  
Packing method OP8 shall be assigned to this type of organic peroxide or self-reactive substance.

**4.1.7.2 Use of intermediate bulk containers**

4.1.7.2.1 The currently assigned organic peroxides specifically listed in packing instruction IBC520 may be transported in IBCs in accordance with this packing instruction. IBCs shall conform to the requirements of chapter 6.5 and shall meet its test provisions for packing group II.

4.1.7.2.2 Other organic peroxides and self-reactive substances of type F may be transported in IBCs under conditions established by the competent authority of the country of origin when, on the basis of the appropriate tests, that competent authority is satisfied that such transport may be safely conducted. The tests undertaken shall include those necessary:

- .1 to prove that the organic peroxide (or self-reactive substance) complies with the principles for classification;
- .2 to prove the compatibility of all materials normally in contact with the substance during the transport;
- .3 to determine, when applicable, the control and emergency temperatures associated with the transport of the product in the IBC concerned as derived from the SADT;
- .4 to design, when applicable, pressure and emergency relief devices; and
- .5 to determine if any special provisions are necessary for safe transport of the substance.

4.1.7.2.3 For self-reactive substances, temperature control is required according to 2.4.2.3.4. For organic peroxides, temperature control is required according to 2.5.3.4.1. Temperature control provisions are given in 7.3.7.

4.1.7.2.4 Emergencies to be taken into account are self-accelerating decomposition and fire engulfment. To prevent explosive rupture of metal or composite IBCs with a complete metal casing, the emergency relief devices shall be designed to vent all the decomposition products and vapours evolved during self-accelerating decomposition or during a period of not less than one hour of complete fire engulfment calculated by the equations given in 4.2.1.13.8.

**4.1.8 Special packing provisions for infectious substances of category A (class 6.2, UN 2814 and UN 2900)**

4.1.8.1 Consignors of infectious substances shall ensure that packages are prepared in such a manner that they arrive at their destination in good condition and present no hazard to persons or animals during transport.

- 4.1.8.2 The definitions in 1.2.1 and the general packing provisions of 4.1.1.1 to 4.1.1.14, except 4.1.1.10 to 4.1.1.12, apply to infectious substances packages. However, liquids shall only be filled into packagings which have an appropriate resistance to the internal pressure that may develop under normal conditions of transport.
- 4.1.8.3 An itemized list of contents shall be enclosed between the secondary packaging and the outer packaging. When the infectious substances to be transported are unknown, but suspected of meeting the criteria for inclusion in category A, the words “suspected category A infectious substance” shall be shown, in parentheses, following the proper shipping name on the document inside the outer packaging.
- 4.1.8.4 Before an empty packaging is returned to the consignor, or sent elsewhere, it shall be disinfected or sterilized to nullify any hazard and any label or mark indicating that it had contained an infectious substance shall be removed or obliterated.
- 4.1.8.5 Provided an equivalent level of performance is maintained, the following variations in the primary receptacles placed within an intermediate packaging are allowed without further testing of the completed package:
- .1 Primary receptacles of equivalent or smaller size as compared to the tested primary receptacles may be used provided:
    - (a) the primary receptacles are of similar design to the tested primary receptacle (such as shape: round, rectangular, etc.);
    - (b) the material of construction of the primary receptacle (glass, plastics, metal, etc.) offers resistance to impact and stacking forces equal to or greater than that of the originally tested primary receptacle;
    - (c) the primary receptacles have the same or smaller openings and the closure is of similar design (such as screw cap, friction lid, etc.);
    - (d) sufficient additional cushioning material is used to take up void spaces and to prevent significant movement of the primary receptacles; and
    - (e) primary receptacles are oriented within the intermediate packaging in the same manner as in the tested package.
  - .2 A lesser number of the tested primary receptacles, or of the alternative types of primary receptacles identified in .1 above, may be used provided sufficient cushioning is added to fill the void space(s) and to prevent significant movement of the primary receptacles.

## 4.1.9 Special packing provisions for radioactive material

### 4.1.9.1 General

- 4.1.9.1.1 Radioactive material, packagings and packages shall meet the provisions of chapter 6.4. The quantity of radioactive material in a package shall not exceed the limits specified in 2.7.2.2, 2.7.2.4.1, 2.7.2.4.4, 2.7.2.4.5, 2.7.2.4.6 and 4.1.9.3.

The types of packages for radioactive materials covered by the provisions of this Code are:

- .1 Excepted package (see 1.5.1.5);
- .2 Industrial package Type 1 (Type IP-1 package);
- .3 Industrial package Type 2 (Type IP-2 package);
- .4 Industrial package Type 3 (Type IP-3 package);
- .5 Type A package;
- .6 Type B(U) package;
- .7 Type B(M) package;
- .8 Type C package.

Packages containing fissile material or uranium hexafluoride are subject to additional requirements.

- 4.1.9.1.2 The non-fixed contamination on the external surfaces of any package shall be kept as low as practicable and, under routine conditions of transport, shall not exceed the following limits:
- (a) 4 Bq/cm<sup>2</sup> for beta and gamma emitters and low-toxicity alpha emitters, and
  - (b) 0.4 Bq/cm<sup>2</sup> for all other alpha emitters.

These limits are applicable when averaged over any area of 300 cm<sup>2</sup> of any part of the surface.

- 4.1.9.1.3 A package shall not contain any items other than those that are necessary for the use of the radioactive material. The interaction between these items and the package under the conditions of transport applicable to the design shall not reduce the safety of the package.

**Part 4 – Packing and tank provisions**

- 4.1.9.1.4 Except as provided in 7.1.4.5.11, the level of non-fixed contamination on the external and internal surfaces of overpacks, cargo transport units and conveyances shall not exceed the limits specified in 4.1.9.1.2. This requirement does not apply to the internal surfaces of freight containers being used as packagings, either loaded or empty.
- 4.1.9.1.5 For radioactive material having other dangerous properties the package design shall take into account those properties. Radioactive material with a subsidiary hazard, packaged in packages that do not require competent authority approval, shall be transported in packagings, IBCs, tanks or bulk containers fully complying with the provisions of the relevant chapters of part 6 as appropriate, as well as applicable provisions of chapters 4.1, 4.2 or 4.3 for that subsidiary hazard.
- 4.1.9.1.6 Before a packaging is first used to transport radioactive material, it shall be confirmed that it has been manufactured in conformity with the design specifications to ensure compliance with the relevant provisions of this Code and any applicable certificate of approval. The following requirements shall also be fulfilled, if applicable:
- .1 if the design pressure of the containment system exceeds 35 kPa (gauge), it shall be ensured that the containment system of each packaging conforms to the approved design requirements relating to the capability of that system to maintain its integrity under that pressure;
  - .2 for each packaging intended for use as a Type B(U), Type B(M) or Type C package and for each packaging intended to contain fissile material, it shall be ensured that the effectiveness of its shielding and containment and, where necessary, the heat transfer characteristics and the effectiveness of the confinement system are within the limits applicable to or specified for the approved design;
  - .3 for each packaging intended to contain fissile material, it shall be ensured that the effectiveness of the criticality safety features is within the limits applicable to or specified for the design and in particular where, in order to comply with the requirements of 6.4.11.1 neutron poisons are specifically included, checks shall be performed to confirm the presence and distribution of those neutron poisons.
- 4.1.9.1.7 Before each shipment of any package, it shall be ensured that the package contains neither:
- .1 radionuclides different from those specified for the package design; nor
  - .2 contents in a form, or physical or chemical state different from those specified for the package design.
- 4.1.9.1.8 Before each shipment of any package, it shall be ensured that all the requirements specified in the relevant provisions of this Code and in the applicable certificates of approval have been fulfilled. The following requirements shall also be fulfilled, if applicable:
- .1 it shall be ensured that lifting attachments which do not meet the requirements of 6.4.2.2 have been removed or otherwise rendered incapable of being used for lifting the package, in accordance with 6.4.2.3;
  - .2 each Type B(U), Type B(M) and Type C package shall be held until equilibrium conditions have been approached closely enough to demonstrate compliance with the requirements for temperature and pressure unless an exemption from these requirements has received unilateral approval;
  - .3 for each Type B(U), Type B(M) and Type C package, it shall be ensured by inspection and/or appropriate tests that all closures, valves and other openings of the containment system through which the radioactive contents might escape are properly closed and, where appropriate, sealed in the manner for which the demonstrations of compliance with the requirements of 6.4.8.8 and 6.4.10.3 were made;
  - .4 for packages containing fissile material the measurement specified in 6.4.11.5 (b) and the tests to demonstrate closure of each package as specified in 6.4.11.8 shall be performed.
  - .5 for packages intended to be used for shipment after storage, it shall be ensured that all packaging components and radioactive contents have been maintained during storage in a manner such that all the requirements specified in the relevant provisions of this Code and in the applicable certificates of approval have been fulfilled.
- 4.1.9.1.9 The consignor shall also have a copy of any instructions with regard to the proper closing of the package and any preparation for shipment before making any shipment under the terms of the certificates.
- 4.1.9.1.10 Except for consignments under exclusive use, the transport index of any package or overpack shall not exceed 10, nor shall the criticality safety index of any package or overpack exceed 50.
- 4.1.9.1.11 Except for packages or overpacks transported under exclusive use by rail or by road under the conditions specified in 7.1.4.5.5.1, or under exclusive use and special arrangement by ship under the conditions specified in 7.1.4.5.7, the maximum dose rate at any point on any external surface of a package or overpack shall not exceed 2 mSv/h.
- 4.1.9.1.12 The maximum dose rate at any point on any external surface of a package or overpack under exclusive use shall not exceed 10 mSv/h.
- 4.1.9.1.13 Pyrophoric radioactive material shall be packaged in Type A, Type B(U), Type B(M) or Type C packages and shall also be suitably inerted.



**4.1.9.2 Provisions and controls for transport of LSA material and SCO**

- 4.1.9.2.1** The quantity of LSA material or SCO in a single Type IP-1 package, Type IP-2 package, Type IP-3 package, or object or collection of objects, whichever is appropriate, shall be so restricted that the external dose rate at 3 m from the unshielded material or object or collection of objects does not exceed 10 mSv/h.
- 4.1.9.2.2** For LSA material and SCO which are or contain fissile material, which is not excepted under 2.7.2.3.5, the applicable requirements of 7.1.4.5.15 and 7.1.4.5.16 shall be met.
- 4.1.9.2.3** For LSA material and SCO which are or contain fissile material, the applicable requirements of 6.4.11.1 shall be met.
- 4.1.9.2.4** LSA material and SCO in groups LSA-I, SCO-I and SCO-III may be transported unpackaged under the following conditions:
- .1 all unpackaged material other than ores containing only naturally occurring radionuclides shall be transported in such a manner that, under routine conditions of transport, there will be no escape of the radioactive contents from the conveyance nor will there be any loss of shielding;
  - .2 each conveyance shall be under exclusive use, except when only transporting SCO-I on which the contamination on the accessible and the inaccessible surfaces is not greater than ten times the applicable level specified in 2.7.1.2;
  - .3 for SCO-I where it is suspected that non-fixed contamination exists on inaccessible surfaces in excess of the values specified in 2.7.2.3.2.1.1, measures shall be taken to ensure that the radioactive material is not released into the conveyance; and
  - .4 unpackaged fissile material shall meet the requirements of 2.7.2.3.5.5.
  - .5 for SCO-III;
    - .1 transport shall be under exclusive use by road, rail, inland waterway or sea;
    - .2 stacking shall not be permitted;
    - .3 all activities associated with the shipment, including radiation protection, emergency response and any special precautions or special administrative or operational controls that are to be employed during transport shall be described in a transport plan. The transport plan shall demonstrate that the overall level of safety in transport is at least equivalent to that which would be provided if the requirements of 6.4.7.14 (only for the test specified in 6.4.15.6, preceded by the tests specified in 6.4.15.2 and 6.4.15.3) had been met.
    - .4 the requirements of 6.4.5.1 and 6.4.5.2 for a Type IP-2 package shall be satisfied, except that the maximum damage referred to in 6.4.15.4 may be determined based on provisions in the transport plan, and the requirements of 6.4.15.5 are not applicable.
    - .5 the object and any shielding are secured to the conveyance in accordance with 6.4.2.1.
    - .6 the shipment shall be subject to multilateral approval.
- 4.1.9.2.5** LSA material and SCO, except as otherwise specified in 4.1.9.2.4, shall be packaged in accordance with table 4.1.9.2.5.

**Table 4.1.9.2.5 – Industrial package provisions for LSA material and SCO**

| Radioactive contents | Industrial package type |                         |
|----------------------|-------------------------|-------------------------|
|                      | Exclusive use           | Not under exclusive use |
| LSA-I                |                         |                         |
| Solid <sup>a</sup>   | Type IP-1               | Type IP-1               |
| Liquid               | Type IP-1               | Type IP-2               |
| LSA-II               |                         |                         |
| Solid                | Type IP-2               | Type IP-2               |
| Liquid and gas       | Type IP-2               | Type IP-3               |
| LSA-III              | Type IP-2               | Type IP-3               |
| SCO-I <sup>a</sup>   | Type IP-1               | Type IP-1               |
| SCO-II               | Type IP-2               | Type IP-2               |

<sup>a</sup> Under the conditions specified in 4.1.9.2.4, LSA-I material and SCO-I may be transported unpackaged.

**4.1.9.3 Packages containing fissile material**

The contents of packages containing fissile material shall be as specified for the package design either directly in the provisions of this Code or in the certificate of approval.



## Chapter 4.2

### *Use of portable tanks and multiple-element gas containers (MEGCs)*

The provisions of this chapter also apply to road tank vehicles to the extent indicated in chapter 6.8.

#### 4.2.0 Transitional provisions

4.2.0.1 The provisions for the use and construction of portable tanks in this chapter and chapter 6.7 are based on the United Nations *Recommendations on the Transport of Dangerous Goods*. IMO type portable tanks and road tank vehicles certified and approved prior to 1 January 2003 in accordance with the provisions of the IMDG Code in force on 1 July 1999 (amendment 29) may continue to be used provided that they are found to meet the applicable periodic inspections and test provisions. They shall meet the provisions set out in columns (13) and (14) of chapter 3.2. Detailed explanation and construction provisions may be found in CCC.1/Circ.3 *Revised guidance on the continued use of existing IMO type portable tanks and road tank vehicles for the transport of dangerous goods*.

**Note:** For ease of reference, the following descriptions of existing IMO type tanks are included:

*IMO type 1 tank* means a portable tank for the transport of substances of classes 3 to 9 fitted with pressure-relief devices, having a maximum allowable working pressure of 1.75 bar and above.

*IMO type 2 tank* means a portable tank fitted with pressure-relief devices, having a maximum allowable working pressure equal to or above 1.0 bar but below 1.75 bar, intended for the transport of certain dangerous liquids of low hazard and certain solids.

*IMO type 4 tank* means a road tank vehicle for the transport of dangerous goods of classes 3 to 9 and includes a semi-trailer with a permanently attached tank or a tank attached to a chassis, with at least four twist locks which comply with ISO standards, (e.g. ISO 1161:1984).

*IMO type 5 tank* means a portable tank fitted with pressure-relief devices which is used for non-refrigerated liquefied gases of class 2.

*IMO type 6 tank* means a road tank vehicle for the transport of non-refrigerated liquefied gases of class 2 and includes a semi-trailer with a permanently attached tank or a tank attached to a chassis which is fitted with items of service equipment and structural equipment necessary for the transport of gases.

*IMO type 7 tank* means a thermally insulated portable tank fitted with items of service and structural equipment necessary for the transport of refrigerated liquefied gases. The portable tank shall be capable of being transported, loaded and discharged without the need of removal of its structural equipment, and shall be capable of being lifted when full. It shall not be permanently secured on board the ship.

*IMO type 8 tank* means a road tank vehicle for the transport of refrigerated liquefied gases of class 2 and includes a semi-trailer with a permanently attached thermally insulated tank fitted with items of service equipment and structural equipment necessary for the transport of refrigerated liquefied gases.

*IMO type 9 tank* means a road gas elements vehicle for the transport of compressed gases of class 2 with elements linked to each other by a manifold, permanently attached to a chassis, which is fitted with items of service equipment and structural equipment necessary for the transport of gases. Elements are cylinders, tubes and bundles of cylinders, intended for the transport of gases as defined in 2.2.1.1.

**Note:** IMO type 4, 6 and 8 road tank vehicles may be constructed after 1 January 2003 in accordance with the provisions of chapter 6.8.

4.2.0.2 UN portable tanks and MEGCs constructed according to a design approval certificate which has been issued before 1 January 2008 may continue to be used provided that they are found to meet the applicable periodic inspection and test provisions.

4.2.0.3 Portable tanks and MEGCs manufactured before 1 January 2012, that conform to the marking provisions of 6.7.2.20.1, 6.7.3.16.1, 6.7.4.15.1 or 6.7.5.13.1 of the IMDG Code in force on 1 January 2010 (amendment 34-08), as relevant, may continue to be used if they comply with all other relevant provisions of the current edition of the Code including, when applicable, the requirement of 6.7.2.20.1 (g) for marking the symbol "S" on the plate when the shell or the compartment is divided by surge plates into sections of not more than 7,500 L capacity. When the shell, or the compartment, was already divided by surge plates into sections of not more than 7,500 L capacity before 1 January 2012, the capacity of the shell, or respectively of the compartment, need not be supplemented with the symbol "S" until the next periodic inspection or test according to 6.7.2.19.5 is performed.

Portable tanks manufactured before 1 January 2014 need not be marked with the portable tank instruction as required in 6.7.2.20.2, 6.7.3.16.2 and 6.7.4.15.2 until the next periodic inspection and test.

Portable tanks and MEGCs manufactured before 1 January 2014 need not comply with the requirements of 6.7.2.13.1.6, 6.7.3.9.1.5, 6.7.4.8.1.5 and 6.7.5.6.1 (d) concerning the marking of the pressure relief devices.

IMO portable tanks manufactured before 1 January 2003 shall be marked with an indication of the portable tank instruction for which it meets the minimum test pressure, minimum shell thickness, pressure relief requirements and bottom opening requirements as shown in 4.2.5.2.6 as required in 6.7.2.20.2, 6.7.3.16.2 and 6.7.4.15.2. These portable tanks need not be marked with the portable tank instruction until the next periodic inspection and test.

## 4.2.1 General provisions for the use of portable tanks for the transport of substances of class 1 and classes 3 to 9

- 4.2.1.1 This section provides general provisions applicable to the use of portable tanks for the transport of substances of classes 1, 3, 4, 5, 6, 7, 8 and 9. In addition to these general provisions, portable tanks shall conform to the design, construction, inspection and testing provisions detailed in 6.7.2. Substances shall be transported in portable tanks conforming to the applicable portable tank instruction and the portable tank special provisions assigned to each substance in the Dangerous Goods List.
- 4.2.1.2 During transport, portable tanks shall be adequately protected against damage to the shell and service equipment resulting from lateral and longitudinal impact and overturning. If the shell and service equipment are so constructed as to withstand impact or overturning, it need not be protected in this way. Examples of such protection are given in 6.7.2.17.5.
- 4.2.1.3 Certain substances are chemically unstable. They are accepted for transport only when the necessary steps have been taken to prevent their dangerous decomposition, transformation or polymerization during transport. To this end, care shall in particular be taken to ensure that shells do not contain any substances liable to promote these reactions.
- 4.2.1.4 The temperature of the outer surface of the shell, excluding openings and their closures, or of the thermal insulation shall not exceed 70°C during transport. When necessary, the shell shall be thermally insulated.
- 4.2.1.5 Empty portable tanks not cleaned and not gas-free shall comply with the same provisions as portable tanks filled with the previous substance.
- 4.2.1.6 Substances shall not be transported in adjoining compartments of shells when they may react dangerously with each other and cause:
- .1 combustion and/or evolution of considerable heat;
  - .2 evolution of flammable, toxic or asphyxiant gases;
  - .3 the formation of corrosive substances;
  - .4 the formation of unstable substances;
  - .5 dangerous rise in pressure.
- 4.2.1.7 The design approval certificate, the test report and the certificate showing the results of the initial inspection and test for each portable tank issued by the competent authority or its authorized body shall be retained by the authority or body and the owner. Owners shall be able to provide this documentation upon the request of any competent authority.
- 4.2.1.8 Unless the name of the substance(s) being transported appears on the metal plate described in 6.7.2.20.2, a copy of the certificate specified in 6.7.2.18.1 shall be made available upon the request of a competent authority or its authorized body and readily provided by the consignor, consignee or agent, as appropriate.
- 4.2.1.9 **Degree of filling**
- 4.2.1.9.1 Prior to filling, the shipper shall ensure that the appropriate portable tank is used and that the portable tank is not loaded with substances which, in contact with the materials of the shell, gaskets, service equipment and any protective linings, are likely to react dangerously with them to form dangerous products or appreciably weaken these materials. The shipper may need to consult the manufacturer of the substance in conjunction with the competent authority for guidance on the compatibility of the substance with the portable tank materials.
- 4.2.1.9.1.1 Portable tanks shall not be filled in excess of the maximum degree of filling specified in 4.2.1.9.2 to 4.2.1.9.6. The applicability of 4.2.1.9.2, 4.2.1.9.3 or 4.2.1.9.5.1 to individual substances is specified in the applicable portable tank instructions or special provisions in 4.2.5.2.6 or 4.2.5.3 and columns 13 and 14 of the Dangerous Goods List.



**Part 4 – Packing and tank provisions**

4.2.1.9.2 The maximum degree of filling (in %) for general use is determined by the formula:

$$\text{Degree of filling} = \frac{97}{1 + \alpha(t_r - t_f)}$$

4.2.1.9.3 The maximum degree of filling (in %) for liquids of class 6.1 and class 8, in packing groups I and II, and liquids with an absolute vapour pressure of more than 175 kPa (1.75 bar) at 65°C, or for liquids identified as marine pollutants is determined by the formula:

$$\text{Degree of filling} = \frac{95}{1 + \alpha(t_r - t_f)}$$

4.2.1.9.4 In these formulae,  $\alpha$  is the mean coefficient of cubical expansion of the liquid between the mean temperature of the liquid during filling ( $t_f$ ) and the maximum mean bulk temperature during transport ( $t_r$ ) (both in °C). For liquids transported under ambient conditions,  $\alpha$  could be calculated by the formula:

$$\alpha = \frac{d_{15} - d_{50}}{35 d_{50}}$$

in which  $d_{15}$  and  $d_{50}$  are the densities of the liquid at 15°C and 50°C, respectively.

4.2.1.9.4.1 The maximum mean bulk temperature ( $t_r$ ) shall be taken as 50°C except that, for journeys under temperate or extreme climatic conditions, the competent authorities concerned may agree to a lower or require a higher temperature, as appropriate.

4.2.1.9.5 The provisions of 4.2.1.9.2 to 4.2.1.9.4.1 do not apply to portable tanks which contain substances maintained at a temperature above 50°C during transport (such as by means of a heating device). For portable tanks equipped with a heating device, a temperature regulator shall be used to ensure the maximum degree of filling is not more than 95% full at any time during transport.

4.2.1.9.5.1 The maximum degree of filling (in %) for solids transported above their melting points and for elevated temperature liquids shall be determined by the following formula:

$$\text{Degree of filling} = 95 \frac{d_r}{d_f}$$

in which  $d_f$  and  $d_r$  are the densities of the liquid at the mean temperature of the liquid during filling and the maximum mean bulk temperature during transport respectively.

4.2.1.9.6 Portable tanks shall not be offered for transport:

- .1 with a degree of filling, for liquids having a viscosity less than 2,680 mm<sup>2</sup>/s at 20°C or at the maximum temperature of the substance during transport in the case of a heated substance, of more than 20% but less than 80% unless the shells of portable tanks are divided, by partitions or surge plates, into sections of not more than 7,500 L capacity;
- .2 with residue of substances previously transported adhering to the outside of the shell or service equipment;
- .3 when leaking or damaged to such an extent that the integrity of the portable tank or its lifting or securing arrangements may be affected; and
- .4 unless the service equipment has been examined and found to be in good working order.

For certain dangerous substances, a lower degree of filling may be required.

4.2.1.9.7 Forklift pockets of portable tanks shall be closed off where the tank is filled. This provision does not apply to portable tanks which, according to 6.7.2.17.4, need not be provided with a means of closing off the forklift pockets.

4.2.1.9.8 Portable tanks shall not be filled or discharged while they remain on board.

#### 4.2.1.10 Additional provisions applicable to the transport of class 3 substances in portable tanks

All portable tanks intended for the transport of flammable liquids shall be closed and be fitted with relief devices in accordance with 6.7.2.8 to 6.7.2.15.

#### 4.2.1.11 Additional provisions applicable to the transport of class 4 substances (other than class 4.1 self-reactive substances) in portable tanks

[Reserved]

**Note:** For class 4.1 self-reactive substances, see 4.2.1.13.

#### 4.2.1.12 Additional provisions applicable to the transport of class 5.1 substances in portable tanks

[Reserved]

- 4.2.1.13 Additional provisions applicable to the transport of class 5.2 substances and class 4.1 self-reactive substances in portable tanks**
- 4.2.1.13.1** Each substance shall have been tested and a report submitted to the competent authority of the country of origin for approval. Notification thereof shall be sent to the competent authority of the country of destination. The notification shall contain relevant transport information and the report with test results. The tests undertaken shall include those necessary:
- .1 to prove the compatibility of all materials normally in contact with the substance during transport;
  - .2 to provide data for the design of the pressure and emergency relief devices, taking into account the design characteristics of the portable tank.
- Any additional provisions necessary for safe transport of the substance shall be clearly described in the report.
- 4.2.1.13.2** The following provisions apply to portable tanks intended for the transport of type F organic peroxides or type F self-reactive substances with a self-accelerating decomposition temperature (SADT) of 55°C or more. In case of conflict, these provisions prevail over those specified in 6.7.2. Emergencies to be taken into account are self-accelerating decomposition of the substance and fire-engulfment as described in 4.2.1.13.8.
- 4.2.1.13.3** The additional provisions for transport of organic peroxides or self-reactive substances with an SADT less than 55°C in portable tanks shall be specified by the competent authority of the country of origin. Notification thereof shall be sent to the competent authority of the country of destination.
- 4.2.1.13.4** The portable tank shall be designed for a test pressure of at least 0.4 MPa (4 bar).
- 4.2.1.13.5** Portable tanks shall be fitted with temperature-sensing devices.
- 4.2.1.13.6** Portable tanks shall be fitted with pressure-relief devices and emergency relief devices. Vacuum-relief devices may also be used. Pressure-relief devices shall operate at pressures determined according to both the properties of the substance and the construction characteristics of the portable tank. Fusible elements are not allowed in the shell.
- 4.2.1.13.7** The pressure-relief devices shall consist of spring-loaded valves fitted to prevent significant build-up within the portable tank of the decomposition products and vapours released at a temperature of 50°C. The capacity and start-to-discharge pressure of the relief valves shall be based on the results of the tests specified in 4.2.1.13.1. The start-to-discharge pressure shall, however, in no case be such that liquid would escape from the valve(s) if the portable tank were overturned.
- 4.2.1.13.8** The emergency relief devices may be of the spring-loaded or frangible types, or a combination of the two, designed to vent all the decomposition products and vapours evolved during a period of not less than one hour of complete fire-engulfment as calculated by the following formula:

$$q = 70961FA^{0.82}$$

where:

$q$  = heat absorption (W)

$A$  = wetted area (m<sup>2</sup>)

$F$  = insulation factor;

$F = 1$  for non-insulated vessels, or

$F = \frac{U(923 - T)}{47032}$  for insulated shells

where:

$K$  = heat conductivity of insulation layer (W·m<sup>-1</sup>·K<sup>-1</sup>)

$L$  = thickness of insulation layer (m)

$U = K/L$  = heat transfer coefficient of the insulation (W·m<sup>-2</sup>·K<sup>-1</sup>)

$T$  = temperature of substance at relieving conditions (K)

The start-to-discharge pressure of the emergency relief device(s) shall be higher than that specified in 4.2.1.13.7 and based on the results of the tests referred to in 4.2.1.13.1. The emergency relief devices shall be dimensioned in such a way that the maximum pressure in the tank never exceeds the test pressure of the portable tank.

**Note:** An example of a method to determine the size of emergency relief devices is given in appendix 5 of the *Manual of Tests and Criteria*.

- 4.2.1.13.9** For insulated portable tanks, the capacity and setting of emergency relief device(s) shall be determined assuming a loss of insulation from 1% of the surface area.

**Part 4 – Packing and tank provisions**

- 4.2.1.13.10 Vacuum-relief devices and spring-loaded valves shall be provided with flame arresters. Due attention shall be paid to the reduction of the relief capacity caused by the flame arrester.
- 4.2.1.13.11 Service equipment such as valves and external piping shall be so arranged that no substance remains in them after filling the portable tank.
- 4.2.1.13.12 Portable tanks may be either insulated or protected by a sunshield. If the SADT of the substance in the portable tank is 55°C or less, or the portable tank is constructed of aluminium, the portable tank shall be completely insulated. The outer surface shall be finished in white or bright metal.
- 4.2.1.13.13 The degree of filling shall not exceed 90% at 15°C.
- 4.2.1.13.14 The mark as required in 6.7.2.20.2 shall include the UN number and the technical name with the approved concentration of the substance concerned.
- 4.2.1.13.15 Organic peroxides and self-reactive substances specifically listed in portable tank instruction T23 in 4.2.5.2.6 may be transported in portable tanks.
- 4.2.1.14 **Additional provisions applicable to the transport of class 6.1 substances in portable tanks**  
[Reserved]
- 4.2.1.15 **Additional provisions applicable to the transport of class 6.2 substances in portable tanks**  
[Reserved]
- 4.2.1.16 **Additional provisions applicable to the transport of class 7 substances in portable tanks**
- 4.2.1.16.1 Portable tanks used for the transport of radioactive material shall not be used for the transport of other goods.
- 4.2.1.16.2 The degree of filling for portable tanks shall not exceed 90% or, alternatively, any other value approved by the competent authority.
- 4.2.1.17 **Additional provisions applicable to the transport of class 8 substances in portable tanks**
- 4.2.1.17.1 Pressure-relief devices of portable tanks used for the transport of class 8 substances shall be inspected at intervals not exceeding one year.
- 4.2.1.18 **Additional provisions applicable to the transport of class 9 substances in portable tanks**  
[Reserved]
- 4.2.1.19 **Additional provisions applicable to the transport of solid substances transported above their melting point**
- 4.2.1.19.1 Solid substances transported or offered for transport above their melting point which are not assigned a portable tank instruction in column 13 of the Dangerous Goods List of chapter 3.2 or when the assigned portable tank instruction does not apply to transport at temperatures above their melting point may be transported in portable tanks provided that the solid substances are classified in classes 4.1, 4.2, 4.3, 5.1, 6.1, 8 or 9 and have no subsidiary hazard other than that of class 6.1 or class 8 and are in packing group II or III.
- 4.2.1.19.2 Unless otherwise indicated in the Dangerous Goods List, portable tanks used for the transport of these solid substances above their melting point shall conform to the provisions of portable tank instruction T4 for solid substances of packing group III or T7 for solid substances of packing group II. A portable tank that affords an equivalent or greater level of safety may be selected in accordance with 4.2.5.2.5. The maximum degree of filling (in %) shall be determined according to 4.2.1.9.5 (TP3).
- 4.2.2 **General provisions for the use of portable tanks for the transport of non-refrigerated liquefied gases and chemicals under pressure**
- 4.2.2.1 This section provides general provisions applicable to the use of portable tanks for the transport of non-refrigerated liquefied gases of class 2 and chemicals under pressure.
- 4.2.2.2 Portable tanks shall conform to the design, construction, inspection and testing provisions detailed in 6.7.3. Non-refrigerated liquefied gases and chemicals under pressure shall be transported in portable tanks conforming to portable tank instruction T50 as described in 4.2.5.2.6 and any portable tank special provisions assigned to specific non-refrigerated liquefied gases in the Dangerous Goods List and described in 4.2.5.3.

- 4.2.2.3 During transport, portable tanks shall be adequately protected against damage to the shell and service equipment resulting from lateral and longitudinal impact and overturning. If the shell and service equipment are so constructed as to withstand impact or overturning, it need not be protected in this way. Examples of such protection are given in 6.7.3.13.5.
- 4.2.2.4 Certain non-refrigerated liquefied gases are chemically unstable. They are accepted for transport only when the necessary steps have been taken to prevent their dangerous decomposition, transformation or polymerization during transport. To this end, care shall be taken to ensure that portable tanks do not contain any non-refrigerated liquefied gases liable to promote these reactions.
- 4.2.2.5 Unless the name of the gas(es) being transported appears on the metal plate described in 6.7.3.16.2, a copy of the certificate specified in 6.7.3.14.1 shall be made available upon a competent authority request and readily provided by the consignor, consignee or agent, as appropriate.
- 4.2.2.6 Empty portable tanks not cleaned and not gas-free shall comply with the same provisions as portable tanks filled with the previous non-refrigerated liquefied gas.
- 4.2.2.7 **Filling**
- 4.2.2.7.1 Prior to filling, the shipper shall ensure that the portable tank is approved for the non-refrigerated liquefied gas or the propellant of the chemical under pressure to be transported and that the portable tank is not loaded with non-refrigerated liquefied gases, or with chemicals under pressure which, in contact with the materials of the shell, gaskets and service equipment, are likely to react dangerously with them to form dangerous products or appreciably weaken these materials. During filling, the temperature of the non-refrigerated liquefied gas or propellant of chemicals under pressure shall fall within the limits of the design temperature range.
- 4.2.2.7.2 The maximum mass of non-refrigerated liquefied gas per litre of shell capacity (kg/L) shall not exceed the density of the non-refrigerated liquefied gas at 50°C multiplied by 0.95. Furthermore, the shell shall not be liquid-full at 60°C.
- 4.2.2.7.3 Portable tanks shall not be filled above their maximum permissible gross mass and the maximum permissible load mass specified for each gas to be transported.
- 4.2.2.7.4 Portable tanks shall not be filled or discharged while they remain on board.
- 4.2.2.8 Portable tanks shall not be offered for transport:
- .1 in an ullage condition liable to produce an unacceptable hydraulic force due to surge within the portable tank;
  - .2 when leaking;
  - .3 when damaged to such an extent that the integrity of the tank or its lifting or securing arrangements may be affected; and
  - .4 unless the service equipment has been examined and found to be in good working order.
- 4.2.2.9 Forklift pockets of portable tanks shall be closed off when the tank is filled. This provision does not apply to portable tanks which, according to 6.7.3.13.4, need not be provided with a means of closing off the forklift pockets.

#### 4.2.3 **General provisions for the use of portable tanks for the transport of refrigerated liquefied gases of class 2**

- 4.2.3.1 This section provides general provisions applicable to the use of portable tanks for the transport of refrigerated liquefied gases.
- 4.2.3.2 Portable tanks shall conform to the design, construction, inspection and testing provisions detailed in 6.7.4. Refrigerated liquefied gases shall be transported in portable tanks conforming to portable tank instruction T75 as described in 4.2.5.2.6 and the portable tank special provisions assigned to each substance in column 14 of the Dangerous Goods List and described in 4.2.5.3.
- 4.2.3.3 During transport, portable tanks shall be adequately protected against damage to the shell and service equipment resulting from lateral and longitudinal impact and overturning. If the shell and service equipment are so constructed as to withstand impact or overturning, it need not be protected in this way. Examples of such protection are provided in 6.7.4.12.5.
- 4.2.3.4 Unless the name of the gas(es) being transported appears on the metal plate described in 6.7.4.15.2, a copy of the certificate specified in 6.7.4.13.1 shall be made available upon a competent authority request and readily provided by the consignor, consignee or agent, as appropriate.

**Part 4 – Packing and tank provisions**

4.2.3.5 Empty portable tanks not cleaned and not gas-free shall comply with the same provisions as portable tanks filled with the previous substance.

**4.2.3.6 Filling**

4.2.3.6.1 Prior to filling, the shipper shall ensure that the portable tank is approved for the refrigerated liquefied gas to be transported and that the portable tank is not loaded with refrigerated liquefied gases which, in contact with the materials of the shell, gaskets and service equipment, are likely to react dangerously with them to form dangerous products or appreciably weaken these materials. During filling, the temperature of the refrigerated liquefied gas shall be within the limits of the design temperature range.

△ 4.2.3.6.2 In estimating the initial quantity of gas filled into the shell, the necessary holding time for the intended journey, including any delays which might be encountered, shall be taken into consideration. The initial quantity of gas filled into the shell, except as provided for in 4.2.3.6.3 and 4.2.3.6.4, shall be such that if the contents, except helium, were to be raised to a temperature at which the vapour pressure is equal to the maximum allowable working pressure (MAWP) the volume occupied by liquid would not exceed 98%.

4.2.3.6.3 Shells intended for the transport of helium can be filled up to but not above the inlet of the pressure-relief device.

△ 4.2.3.6.4 A higher initial quantity of gas filled into the shell may be allowed, subject to approval by the competent authority, when the intended duration of transport is considerably shorter than the holding time.

4.2.3.6.5 Portable tanks shall not be filled or discharged while they remain on board.

**4.2.3.7 Actual holding time**

4.2.3.7.1 The actual holding time shall be calculated for each journey in accordance with a procedure recognized by the competent authority, on the basis of the following:

- .1 the reference holding time for the refrigerated liquefied gas to be transported (see 6.7.4.2.8.1) (as indicated on the plate referred to in 6.7.4.15.1);
- .2 the actual filling density;
- .3 the actual filling pressure;
- .4 the lowest set pressure of the pressure-limiting device(s).

4.2.3.7.2 The actual holding time shall be marked either on the portable tank itself or on a metal plate firmly secured to the portable tank, in accordance with 6.7.4.15.2.

△ 4.2.3.7.3 The date at which the actual holding time ends shall be entered in the transport document (see 5.4.1.5.19).

4.2.3.8 Portable tanks shall not be offered for transport:

- .1 in an ullage condition liable to produce an unacceptable hydraulic force due to surge within the shell;
- .2 when leaking;
- .3 when damaged to such an extent that the integrity of the portable tank or its lifting or securing arrangements may be affected;
- .4 unless the service equipment has been examined and found to be in good working order;
- .5 unless the actual holding time for the refrigerated liquefied gas being transported has been determined in accordance with 4.2.3.7 and the portable tank is marked in accordance with 6.7.4.15.2; and
- .6 unless the duration of transport, after taking into consideration any delays which might be encountered, does not exceed the actual holding time.

4.2.3.9 Forklift pockets of portable tanks shall be closed off when the tank is filled. This provision does not apply to portable tanks which, according to 6.7.4.12.4, need not be provided with a means of closing off the forklift pockets.

**4.2.4 General provisions for the use of multiple-element gas containers (MEGCs)**

4.2.4.1 This section provides general requirements applicable to the use of multiple-element gas containers (MEGCs) for the transport of non-refrigerated gases.

4.2.4.2 MEGCs shall conform to the design, construction, inspection and testing requirements detailed in 6.7.5. The elements of MEGCs shall be periodically inspected according to the provisions set out in packing instruction P200 and in 6.2.1.6.

- 4.2.4.3 During transport, MEGCs shall be protected against damage to the elements and service equipment resulting from lateral and longitudinal impact and overturning. If the elements and service equipment are so constructed as to withstand impact or overturning, they need not be protected in this way. Examples of such protection are given in 6.7.5.10.4.
- 4.2.4.4 The periodic testing and inspection requirements for MEGCs are specified in 6.7.5.12. MEGCs or their elements shall not be charged or filled after they become due for periodic inspection but may be transported after the expiry of the time limit.
- 4.2.4.5 **Filling**
- 4.2.4.5.1 Prior to filling, the MEGC shall be inspected to ensure that it is authorized for the gas to be transported and that the applicable provisions of this Code have been met.
- 4.2.4.5.2 Elements of MEGCs shall be filled according to the working pressures, filling ratios and filling provisions specified in packing instruction P200 for the specific gas being filled into each element. In no case shall an MEGC or group of elements be filled as a unit in excess of the lowest working pressure of any given element.
- 4.2.4.5.3 MEGCs shall not be filled above their maximum permissible gross mass.
- 4.2.4.5.4 Isolation valves shall be closed after filling and remain closed during transport. Toxic gases of class 2.3 shall only be transported in MEGCs where each element is equipped with an isolation valve.
- 4.2.4.5.5 The opening(s) for filling shall be closed by caps or plugs. The leakproofness of the closures and equipment shall be verified by the shipper after filling.
- 4.2.4.5.6 MEGCs shall not be offered for filling:
- .1 when damaged to such an extent that the integrity of the pressure receptacles or their structural or service equipment may be affected;
  - .2 unless the pressure receptacles and their structural and service equipment have been examined and found to be in good working order; and
  - .3 unless the required certification, retest, and filling marks are legible.
- 4.2.4.5.7 Multiple-element gas containers (MEGCs) shall not be filled or discharged while they remain on board.
- 4.2.4.6 Filled MEGCs shall not be offered for transport;
- .1 when leaking;
  - .2 when damaged to such an extent that the integrity of the pressure receptacles or their structural or service equipment may be affected;
  - .3 unless the pressure receptacles and their structural and service equipment have been examined and found to be in good working order; and
  - .4 unless the required certification, retest, and filling marks are legible.
- 4.2.4.7 Empty MEGCs that have not been cleaned and purged shall comply with the same requirements as MEGCs filled with the previous substance.

## 4.2.5 Portable tank instructions and special provisions

### 4.2.5.1 General

- 4.2.5.1.1 This section includes the portable tank instructions and special provisions applicable to dangerous goods authorized to be transported in portable tanks. Each portable tank instruction is identified by an alpha-numeric designation (T1 to T75). The Dangerous Goods List in chapter 3.2 indicates the portable tank instruction that shall be used for each substance permitted for transport in a portable tank. When no portable tank instruction appears in the Dangerous Goods List, transport of the substance in portable tanks is not permitted unless a competent authority approval is granted as set out in 6.7.1.3. Portable tank special provisions are assigned to specific dangerous goods in the Dangerous Goods List in chapter 3.2. Each portable tank special provision is identified by an alpha-numeric designation (such as TP1). A listing of the portable tank special provisions is provided in 4.2.5.3.

**Note:** The gases authorized for transport in MEGCs are indicated in the column “MEGC” in Tables 1 and 2 of packing instruction P200 in 4.1.4.1.



Part 4 – Packing and tank provisions

4.2.5.2 Portable tank instructions

4.2.5.2.1 Portable tank instructions apply to dangerous goods of classes 1 to 9. Portable tank instructions provide specific information relevant to portable tank provisions applicable to specific substances. These provisions shall be met in addition to the general provisions in this chapter and chapter 6.7 or chapter 6.10.

4.2.5.2.2 For substances of class 1 and classes 3 to 9, the portable tank instructions indicate the applicable minimum test pressure, the minimum shell thickness (in reference steel or the minimum shell thickness of fibre-reinforced plastics), bottom opening provisions and pressure-relief provisions. In T23, self-reactive substances of class 4.1 and class 5.2 organic peroxides permitted to be transported in portable tanks are listed along with applicable control and emergency temperatures.

△ 4.2.5.2.3 Non-refrigerated liquefied gases are assigned to portable tank instruction T50. T50 provides the maximum allowable working pressures, bottom opening provisions, pressure-relief provisions and filling ratio provisions for non-refrigerated liquefied gases permitted for transport in portable tanks.

4.2.5.2.4 Refrigerated liquefied gases are assigned to portable tank instruction T75.

4.2.5.2.5 **Determination of the appropriate portable tank instructions**

When a specific portable tank instruction is specified in the Dangerous Goods List, additional portable tanks which possess higher test pressures, greater shell thicknesses, more stringent bottom opening and pressure-relief device arrangements may be used. The following guidelines apply to determining the appropriate portable tanks which may be used for transport of particular substances:

| Portable tank instruction specified | Portable tank instructions also permitted   |
|-------------------------------------|---|
| T1                                  | T2, T3, T4, T5, T6, T7, T8, T9, T10, T11, T12, T13, T14, T15, T16, T17, T18, T19, T20, T21, T22 |
| T2                                  | T4, T5, T7, T8, T9, T10, T11, T12, T13, T14, T15, T16, T17, T18, T19, T20, T21, T22             |
| T3                                  | T4, T5, T6, T7, T8, T9, T10, T11, T12, T13, T14, T15, T16, T17, T18, T19, T20, T21, T22         |
| T4                                  | T5, T7, T8, T9, T10, T11, T12, T13, T14, T15, T16, T17, T18, T19, T20, T21, T22                 |
| T5                                  | T10, T14, T19, T20, T22   |
| T6                                  | T7, T8, T9, T10, T11, T12, T13, T14, T15, T16, T17, T18, T19, T20, T21, T22                     |
| T7                                  | T8, T9, T10, T11, T12, T13, T14, T15, T16, T17, T18, T19, T20, T21, T22                         |
| T8                                  | T9, T10, T13, T14, T19, T20, T21, T22   |
| T9                                  | T10, T13, T14, T19, T20, T21, T22   |
| T10                                 | T14, T19, T20, T22  |
| T11                                 | T12, T13, T14, T15, T16, T17, T18, T19, T20, T21, T22   |
| T12                                 | T14, T16, T18, T19, T20, T22  |
| T13                                 | T14, T19, T20, T21, T22   |
| T14                                 | T19, T20, T22   |
| T15                                 | T16, T17, T18, T19, T20, T21, T22   |
| T16                                 | T18, T19, T20, T22  |
| T17                                 | T18, T19, T20, T21, T22   |
| T18                                 | T19, T20, T22   |
| T19                                 | T20, T22  |
| T20                                 | T22   |
| T21                                 | T22   |
| T22                                 | None  |
| T23                                 | None  |
| T50                                 | None  |



4.2.5.2.6 *Portable tank instructions*

Portable tank instructions specify the provisions applicable to a portable tank when used for the transport of specific substances. Portable tank instructions T1 to T22 specify the applicable minimum test pressure, the minimum shell thickness (in millimetres of reference steel) or the minimum shell thickness for fibre-reinforced plastics (FRP) portable tanks, and the pressure relief and bottom-opening provisions.

| T1 – T22 PORTABLE TANK INSTRUCTIONS T1 – T22   |                             |   |   |  |
|--|-----------------------------|---|---|--|
| These portable tank instructions apply to liquid and solid substances of class 1 and classes 3 to 9. The general provisions of section 4.2.1 and the requirements of section 6.7.2 shall be met. The instructions for portable tanks with FRP shells apply to substances of classes or divisions 1, 3, 5.1, 6.1, 6.2, 8 and 9. Additionally, the provisions of chapter 6.10 apply to the portable tanks with FRP shells. |                             |   |   |  |
| Portable tank instruction  | Minimum test pressure (bar) | Minimum shell thickness (in mm – reference steel) (see 6.7.2.4) | Pressure relief provisions <sup>a</sup> (see 6.7.2.8) | Bottom opening provisions <sup>b</sup> (see 6.7.2.6) |
| T1   | 1.5                         | See 6.7.2.4.2   | Normal  | See 6.7.2.6.2  |
| T2   | 1.5                         | See 6.7.2.4.2   | Normal  | See 6.7.2.6.3  |
| T3   | 2.65                        | See 6.7.2.4.2   | Normal  | See 6.7.2.6.2  |
| T4   | 2.65                        | See 6.7.2.4.2   | Normal  | See 6.7.2.6.3  |
| T5   | 2.65                        | See 6.7.2.4.2   | See 6.7.2.8.3   | Not allowed  |
| T6   | 4                           | See 6.7.2.4.2   | Normal  | See 6.7.2.6.2  |
| T7   | 4                           | See 6.7.2.4.2   | Normal  | See 6.7.2.6.3  |
| T8   | 4                           | See 6.7.2.4.2   | Normal  | Not allowed  |
| T9   | 4                           | 6 mm  | Normal  | Not allowed  |
| T10  | 4                           | 6 mm  | See 6.7.2.8.3   | Not allowed  |
| T11  | 6                           | See 6.7.2.4.2   | Normal  | See 6.7.2.6.3  |
| T12  | 6                           | See 6.7.2.4.2   | See 6.7.2.8.3   | See 6.7.2.6.3  |
| T13  | 6                           | 6 mm  | Normal  | Not allowed  |
| T14  | 6                           | 6 mm  | See 6.7.2.8.3   | Not allowed  |
| T15  | 10                          | See 6.7.2.4.2   | Normal  | See 6.7.2.6.3  |
| T16  | 10                          | See 6.7.2.4.2   | See 6.7.2.8.3   | See 6.7.2.6.3  |
| T17  | 10                          | 6 mm  | Normal  | See 6.7.2.6.3  |
| T18  | 10                          | 6 mm  | See 6.7.2.8.3   | See 6.7.2.6.3  |
| T19  | 10                          | 6 mm  | See 6.7.2.8.3   | Not allowed  |
| T20  | 10                          | 8 mm  | See 6.7.2.8.3   | Not allowed  |
| T21  | 10                          | 10 mm   | Normal  | Not allowed  |
| T22  | 10                          | 10 mm   | See 6.7.2.8.3   | Not allowed  |

<sup>a</sup> When the word “Normal” is indicated, all the provisions of 6.7.2.8 apply except for 6.7.2.8.3.

<sup>b</sup> When this column indicates “not allowed”, bottom openings are not permitted when the substance to be transported is a liquid (see 6.7.2.6.1). When the substance to be transported is a solid at all temperatures encountered under normal conditions of transport, bottom openings conforming to the provisions of 6.7.2.6.2 are authorized.





Part 4 – Packing and tank provisions

| T23   |   | PORTABLE TANK INSTRUCTION   |  |                             |   |                   |                     | T23                   |  |
|---|---|-----------------------------|--|-----------------------------|---|-------------------|---------------------|-----------------------|--|
| <p>This portable tank instruction applies to self-reactive substances of class 4.1 and organic peroxides of class 5.2. The general provisions of 4.2.1 and the provisions of 6.7.2 shall be met. The provisions specific to self-reactive substances of class 4.1 and organic peroxides of class 5.2 in 4.2.1.13 shall also be met.</p> <p>△ The formulations not listed in 2.4.2.3.2.3 or 2.5.3.2.4 but listed below may also be transported packed in accordance with packing method OP8 of packing instruction P520 of 4.1.4.1, with the same control and emergency temperatures, if applicable.</p> |   |                             |  |                             |   |                   |                     |                       |  |
| UN No.  | Substance   | Minimum test pressure (bar) | Minimum shell thickness (mm – reference steel) | Bottom opening requirements | Pressure relief requirements                      | Degree of filling | Control temperature | Emergency temperature |  |
| 3109  | <p><b>ORGANIC PEROXIDE TYPE F, LIQUID</b></p> <p><i>tert</i>-Butyl hydroperoxide, not more than 56% in diluent type B<sup>*</sup></p> <p><i>tert</i>-Butyl hydroperoxide,<sup>†</sup> not more than 72% with water</p> <p>Cumyl hydroperoxide, not more than 90% in diluent type A</p> <p>Di-<i>tert</i>-butyl peroxide, not more than 32% in diluent type A</p> <p>Isopropyl cumyl hydroperoxide, not more than 72% in diluent type A</p> <p><i>p</i>-Menthyl hydroperoxide, not more than 72% in diluent type A</p> <p>Pinanyl hydroperoxide, not more than 56% in diluent type A</p>   | 4                           | See 6.7.2.4.2                                  | See 6.7.2.6.3               | See 6.7.2.8.2, 4.2.1.13.6, 4.2.1.13.7, 4.2.1.13.8 | See 4.2.1.13.13   |                     |                       |  |
| 3110  | <p><b>ORGANIC PEROXIDE TYPE F, SOLID</b></p> <p>Dicumyl peroxide<sup>‡</sup></p>  | 4                           | See 6.7.2.4.2                                  | See 6.7.2.6.3               | See 6.7.2.8.2, 4.2.1.13.6, 4.2.1.13.7, 4.2.1.13.8 | See 4.2.1.13.13   |                     |                       |  |
| 3119  | <p><b>ORGANIC PEROXIDE TYPE F, LIQUID, TEMPERATURE CONTROLLED</b></p> <p><i>tert</i>-Amyl peroxyneodecanoate, not more than 47% in diluent type A</p> <p><i>tert</i>-Butyl peroxyacetate, not more than 32% in diluent type B</p> <p><i>tert</i>-Butyl peroxy-2-ethylhexanoate, not more than 32% in diluent type B</p> <p><i>tert</i>-Butyl peroxy-pivalate, not more than 27% in diluent type B</p> <p><i>tert</i>-Butyl peroxy-3,5,5-trimethylhexanoate, not more than 32% in diluent type B</p> <p>Di-(3,5,5-trimethylhexanoyl) peroxide, not more than 38% in diluent type A or type B</p> <p>Peroxyacetic acid, distilled, stabilized<sup>¶</sup></p> | 4                           | See 6.7.2.4.2                                  | See 6.7.2.6.3               | See 6.7.2.8.2, 4.2.1.13.6, 4.2.1.13.7, 4.2.1.13.8 | See 4.2.1.13.13   | §                   | §                     |  |

\* Diluent type B is *tert*-Butyl alcohol.

† Provided that steps have been taken to achieve the safety equivalence of 65% *tert*-butyl hydroperoxide and 35% water.

‡ Maximum quantity per portable tank: 2,000 kg.

§ As approved by the competent authority.

¶ Formulation derived from distillation of peroxyacetic acid originating from peroxyacetic acid in concentration of not more than 41% with water, total active oxygen (peroxyacetic acid + H<sub>2</sub>O<sub>2</sub>) ≤ 9.5%, which fulfils the criteria of 2.5.3.3.2.6. "CORROSIVE" subsidiary hazard placard required (Model No. 8, see 5.2.2.2.2).



Chapter 4.2 – Use of portable tanks and MEGCs

| T23    |  | PORTABLE TANK INSTRUCTION (continued) |  |                             |   |                   |                     |                       | T23 |
|--------|--|---------------------------------------|--|-----------------------------|---|-------------------|---------------------|-----------------------|-----|
| UN No. | Substance  | Minimum test pressure (bar)           | Minimum shell thickness (mm – reference steel) | Bottom opening requirements | Pressure relief requirements                      | Degree of filling | Control temperature | Emergency temperature |     |
| 3120   | ORGANIC PEROXIDE TYPE F, SOLID, TEMPERATURE CONTROLLED | 4                                     | See 6.7.2.4.2                                  | See 6.7.2.6.3               | See 6.7.2.8.2, 4.2.1.13.6, 4.2.1.13.7, 4.2.1.13.8 | See 4.2.1.13.13   | *                   | *                     |     |
| 3229   | SELF-REACTIVE LIQUID TYPE F                            | 4                                     | See 6.7.2.4.2                                  | See 6.7.2.6.3               | See 6.7.2.8.2, 4.2.1.13.6, 4.2.1.13.7, 4.2.1.13.8 | See 4.2.1.13.13   |                     |                       |     |
| 3230   | SELF-REACTIVE SOLID TYPE F                             | 4                                     | See 6.7.2.4.2                                  | See 6.7.2.6.3               | See 6.7.2.8.2, 4.2.1.13.6, 4.2.1.13.7, 4.2.1.13.8 | See 4.2.1.13.13   |                     |                       |     |
| 3239   | SELF-REACTIVE LIQUID TYPE F, TEMPERATURE CONTROLLED    | 4                                     | See 6.7.2.4.2                                  | See 6.7.2.6.3               | See 6.7.2.8.2, 4.2.1.13.6, 4.2.1.13.7, 4.2.1.13.8 | See 4.2.1.13.13   | *                   | *                     |     |
| 3240   | SELF-REACTIVE SOLID TYPE F, TEMPERATURE CONTROLLED     | 4                                     | See 6.7.2.4.2                                  | See 6.7.2.6.3               | See 6.7.2.8.2, 4.2.1.13.6, 4.2.1.13.7, 4.2.1.13.8 | See 4.2.1.13.13   | *                   | *                     |     |

\* As approved by the competent authority.

| T50  |  | PORTABLE TANK INSTRUCTION  |                             |   |                              | T50 |
|--|--|--|-----------------------------|---|------------------------------|-----|
| This portable tank instruction applies to non-refrigerated liquefied gases and chemicals under pressure (UN Nos. 3500, 3501, 3502, 3503, 3504 and 3505). The general provisions of 4.2.2 and the provisions of 6.7.3 shall be met. |  |  |                             |   |                              |     |
| UN No.   | Non-refrigerated liquefied gases   | Maximum allowable working pressure (bar) Small; Bare; Sunshield; Insulated respectively <sup>a</sup> | Openings below liquid level | Pressure relief provisions <sup>b</sup> (see 6.7.3.7) | Maximum filling ratio (kg/L) |     |
| 1005   | Ammonia, anhydrous   | 29.0<br>25.7<br>22.0<br>19.7   | Allowed                     | See 6.7.3.7.3   | 0.53                         |     |
| 1009   | Bromotrifluoromethane (Refrigerant gas R 13B1)                               | 38.0<br>34.0<br>30.0<br>27.5   | Allowed                     | Normal  | 1.13                         |     |
| 1010   | Butadienes, stabilized   | 7.5<br>7.0<br>7.0<br>7.0   | Allowed                     | Normal  | 0.55                         |     |
| 1010   | Butadienes and hydrocarbon mixture, stabilized with more than 40% butadienes | See MAWP definition in 6.7.3.1   | Allowed                     | Normal  | See 4.2.2.7                  |     |
| 1011   | Butane   | 7.0<br>7.0<br>7.0<br>7.0   | Allowed                     | Normal  | 0.51                         |     |
| 1012   | Butylene   | 8.0<br>7.0<br>7.0<br>7.0   | Allowed                     | Normal  | 0.53                         |     |

<sup>a</sup> “Small” means tanks having a shell with a diameter of 1.5 metre or less; “Bare” means tanks having a shell with a diameter of more than 1.5 metre without insulation or sun shield (see 6.7.3.2.12); “Sunshield” means tanks having a shell with a diameter of more than 1.5 metre with sun shield (see 6.7.3.2.12); “Insulated” means tanks having a shell with a diameter of more than 1.5 metre with insulation (see 6.7.3.2.12); (see definition of “Design reference temperature” in 6.7.3.1).

<sup>b</sup> The word “Normal” in the pressure relief column indicates that a frangible disc as specified in 6.7.3.7.3 is not required.

Part 4 – Packing and tank provisions

| T50 PORTABLE TANK INSTRUCTION (continued) T50 |  |  |                             |   |                              |
|---|--|--|-----------------------------|---|------------------------------|
| UN No.  | Non-refrigerated liquefied gases   | Maximum allowable working pressure (bar) Small; Bare; Sunshield; Insulated respectively <sup>a</sup> | Openings below liquid level | Pressure relief provisions <sup>b</sup> (see 6.7.3.7) | Maximum filling ratio (kg/L) |
| 1017  | Chlorine   | 19.0<br>17.0<br>15.0<br>13.5   | Not allowed                 | See 6.7.3.7.3   | 1.25                         |
| 1018  | Chlorodifluoromethane (Refrigerant gas R 22)   | 26.0<br>24.0<br>21.0<br>19.0   | Allowed                     | Normal  | 1.03                         |
| 1020  | Chloropentafluoroethane (Refrigerant gas R 115)  | 23.0<br>20.0<br>18.0<br>16.0   | Allowed                     | Normal  | 1.06                         |
| 1021  | 1-Chloro-1,2,2,2-tetrafluoroethane (Refrigerant gas R 124)                                       | 10.3<br>9.8<br>7.9<br>7.0  | Allowed                     | Normal  | 1.20                         |
| 1027  | Cyclopropane   | 18.0<br>16.0<br>14.5<br>13.0   | Allowed                     | Normal  | 0.53                         |
| 1028  | Dichlorodifluoromethane (Refrigerant gas R 12)   | 16.0<br>15.0<br>13.0<br>11.5   | Allowed                     | Normal  | 1.15                         |
| 1029  | Dichlorofluoromethane (Refrigerant gas R 21)   | 7.0<br>7.0<br>7.0<br>7.0   | Allowed                     | Normal  | 1.23                         |
| 1030  | 1,1-Difluoroethane (Refrigerant gas R 152a)  | 16.0<br>14.0<br>12.4<br>11.0   | Allowed                     | Normal  | 0.79                         |
| 1032  | Dimethylamine, anhydrous   | 7.0<br>7.0<br>7.0<br>7.0   | Allowed                     | Normal  | 0.59                         |
| 1033  | Dimethyl ether   | 15.5<br>13.8<br>12.0<br>10.6   | Allowed                     | Normal  | 0.58                         |
| 1036  | Ethylamine   | 7.0<br>7.0<br>7.0<br>7.0   | Allowed                     | Normal  | 0.61                         |
| 1037  | Ethyl chloride   | 7.0<br>7.0<br>7.0<br>7.0   | Allowed                     | Normal  | 0.80                         |
| 1040  | Ethylene oxide with nitrogen up to a total pressure of 1 MPa (10 bar) at 50°C                    | –<br>–<br>–<br>10.0  | Not allowed                 | See 6.7.3.7.3   | 0.78                         |
| 1041  | Ethylene oxide and carbon dioxide mixture with more than 9% but not more than 87% ethylene oxide | See MAWP definition in 6.7.3.1   | Allowed                     | Normal  | See 4.2.2.7                  |

<sup>a</sup> “Small” means tanks having a shell with a diameter of 1.5 metre or less; “Bare” means tanks having a shell with a diameter of more than 1.5 metre without insulation or sun shield (see 6.7.3.2.12); “Sunshield” means tanks having a shell with a diameter of more than 1.5 metre with sun shield (see 6.7.3.2.12); “Insulated” means tanks having a shell with a diameter of more than 1.5 metre with insulation (see 6.7.3.2.12); (see definition of “Design reference temperature” in 6.7.3.1).

<sup>b</sup> The word “Normal” in the pressure relief column indicates that a frangible disc as specified in 6.7.3.7.3 is not required.



Chapter 4.2 – Use of portable tanks and MEGCs

| T50    |  | PORTABLE TANK INSTRUCTION (continued)  |                             |   |                              | T50 |
|--------|--|--|-----------------------------|---|------------------------------|-----|
| UN No. | Non-refrigerated liquefied gases                             | Maximum allowable working pressure (bar) Small; Bare; Sunshield; Insulated respectively <sup>a</sup> | Openings below liquid level | Pressure relief provisions <sup>b</sup> (see 6.7.3.7) | Maximum filling ratio (kg/L) |     |
| 1055   | Isobutylene  | 8.1<br>7.0<br>7.0<br>7.0   | Allowed                     | Normal  | 0.52                         |     |
| 1060   | Methylacetylene and propadiene mixture, stabilized           | 28.0<br>24.5<br>22.0<br>20.0   | Allowed                     | Normal  | 0.43                         |     |
| 1061   | Methylamine, anhydrous                                       | 10.8<br>9.6<br>7.8<br>7.0  | Allowed                     | Normal  | 0.58                         |     |
| 1062   | Methyl bromide with not more than 2% chloropicrin            | 7.0<br>7.0<br>7.0<br>7.0   | Not allowed                 | See 6.7.3.7.3   | 1.51                         |     |
| 1063   | Methyl chloride (Refrigerant gas R40)                        | 14.5<br>12.7<br>11.3<br>10.0   | Allowed                     | Normal  | 0.81                         |     |
| 1064   | Methyl mercaptan   | 7.0<br>7.0<br>7.0<br>7.0   | Not allowed                 | See 6.7.3.7.3   | 0.78                         |     |
| 1067   | Dinitrogen tetroxide   | 7.0<br>7.0<br>7.0<br>7.0   | Not allowed                 | See 6.7.3.7.3   | 1.30                         |     |
| 1075   | Petroleum gas, liquefied                                     | See MAWP definition in 6.7.3.1   | Allowed                     | Normal  | See 4.2.2.7                  |     |
| 1077   | Propylene  | 28.0<br>24.5<br>22.0<br>20.0   | Allowed                     | Normal  | 0.43                         |     |
| 1078   | Refrigerant gas, N.O.S.                                      | See MAWP definition in 6.7.3.1   | Allowed                     | Normal  | See 4.2.2.7                  |     |
| 1079   | Sulphur dioxide  | 11.6<br>10.3<br>8.5<br>7.6   | Not allowed                 | See 6.7.3.7.3   | 1.23                         |     |
| 1082   | Trifluorochloroethylene, stabilized (Refrigerant gas R 1113) | 17.0<br>15.0<br>13.1<br>11.6   | Not allowed                 | See 6.7.3.7.3   | 1.13                         |     |
| 1083   | Trimethylamine, anhydrous                                    | 7.0<br>7.0<br>7.0<br>7.0   | Allowed                     | Normal  | 0.56                         |     |
| 1085   | Vinyl bromide, stabilized                                    | 7.0<br>7.0<br>7.0<br>7.0   | Allowed                     | Normal  | 1.37                         |     |
| 1086   | Vinyl chloride, stabilized                                   | 10.6<br>9.3<br>8.0<br>7.0  | Allowed                     | Normal  | 0.81                         |     |

<sup>a</sup> “Small” means tanks having a shell with a diameter of 1.5 metre or less; “Bare” means tanks having a shell with a diameter of more than 1.5 metre without insulation or sun shield (see 6.7.3.2.12); “Sunshield” means tanks having a shell with a diameter of more than 1.5 metre with sun shield (see 6.7.3.2.12); “Insulated” means tanks having a shell with a diameter of more than 1.5 metre with insulation (see 6.7.3.2.12); (see definition of “Design reference temperature” in 6.7.3.1).

<sup>b</sup> The word “Normal” in the pressure relief column indicates that a frangible disc as specified in 6.7.3.7.3 is not required.



Part 4 – Packing and tank provisions

| T50    |  | PORTABLE TANK INSTRUCTION (continued)  |                             |   |                              | T50 |
|--------|--|--|-----------------------------|---|------------------------------|-----|
| UN No. | Non-refrigerated liquefied gases   | Maximum allowable working pressure (bar) Small; Bare; Sunshield; Insulated respectively <sup>a</sup> | Openings below liquid level | Pressure relief provisions <sup>b</sup> (see 6.7.3.7) | Maximum filling ratio (kg/L) |     |
| 1087   | Vinyl methyl ether, stabilized   | 7.0<br>7.0<br>7.0<br>7.0   | Allowed                     | Normal  | 0.67                         |     |
| 1581   | Chloropicrin and methyl bromide mixture with more than 2% chloropicrin   | 7.0<br>7.0<br>7.0<br>7.0   | Not allowed                 | See 6.7.3.7.3   | 1.51                         |     |
| 1582   | Chloropicrin and methyl chloride mixture   | 19.2<br>16.9<br>15.1<br>13.1   | Not allowed                 | See 6.7.3.7.3   | 0.81                         |     |
| 1858   | Hexafluoropropylene (Refrigerant gas R 1216)   | 19.2<br>16.9<br>15.1<br>13.1   | Allowed                     | Normal  | 1.11                         |     |
| 1912   | Methyl chloride and methylene chloride mixture   | 15.2<br>13.0<br>11.6<br>10.1   | Allowed                     | Normal  | 0.81                         |     |
| 1958   | 1,2-Dichloro-1,1,2,2-tetrafluoroethane (Refrigerant gas R 114)   | 7.0<br>7.0<br>7.0<br>7.0   | Allowed                     | Normal  | 1.30                         |     |
| 1965   | Hydrocarbon gas, mixture liquefied, N.O.S.   | See MAWP definition in 6.7.3.1   | Allowed                     | Normal  | See 4.2.2.7                  |     |
| 1969   | Isobutane  | 8.5<br>7.5<br>7.0<br>7.0   | Allowed                     | Normal  | 0.49                         |     |
| 1973   | Chlorodifluoromethane and chloropentafluoroethane mixture with fixed boiling point, with approximately 49% chlorodifluoromethane (Refrigerant gas R 502) | 28.3<br>25.3<br>22.8<br>20.3   | Allowed                     | Normal  | 1.05                         |     |
| 1974   | Chlorodifluorobromomethane (Refrigerant gas R 12B1)  | 7.4<br>7.0<br>7.0<br>7.0   | Allowed                     | Normal  | 1.61                         |     |
| 1976   | Octafluorocyclobutane (Refrigerant gas RC 318)   | 8.8<br>7.8<br>7.0<br>7.0   | Allowed                     | Normal  | 1.34                         |     |
| 1978   | Propane  | 22.5<br>20.4<br>18.0<br>16.5   | Allowed                     | Normal  | 0.42                         |     |
| 1983   | 1-Chloro-2,2,2-trifluoroethane (Refrigerant gas R 133a)  | 7.0<br>7.0<br>7.0<br>7.0   | Allowed                     | Normal  | 1.18                         |     |
| 2035   | 1,1,1-Trifluoroethane (Refrigerant gas R 143a)   | 31.0<br>27.5<br>24.2<br>21.8   | Allowed                     | Normal  | 0.76                         |     |

<sup>a</sup> “Small” means tanks having a shell with a diameter of 1.5 metre or less; “Bare” means tanks having a shell with a diameter of more than 1.5 metre without insulation or sun shield (see 6.7.3.2.12); “Sunshield” means tanks having a shell with a diameter of more than 1.5 metre with sun shield (see 6.7.3.2.12); “Insulated” means tanks having a shell with a diameter of more than 1.5 metre with insulation (see 6.7.3.2.12); (see definition of “Design reference temperature” in 6.7.3.1).

<sup>b</sup> The word “Normal” in the pressure relief column indicates that a frangible disc as specified in 6.7.3.7.3 is not required.



Chapter 4.2 – Use of portable tanks and MEGCs

| T50    |  | PORTABLE TANK INSTRUCTION (continued)  |                             |   |                              | T50 |
|--------|--|--|-----------------------------|---|------------------------------|-----|
| UN No. | Non-refrigerated liquefied gases   | Maximum allowable working pressure (bar) Small; Bare; Sunshield; Insulated respectively <sup>a</sup> | Openings below liquid level | Pressure relief provisions <sup>b</sup> (see 6.7.3.7) | Maximum filling ratio (kg/L) |     |
| 2424   | Octafluoropropane (Refrigerant gas R 218)  | 23.1<br>20.8<br>18.6<br>16.6   | Allowed                     | Normal  | 1.07                         |     |
| 2517   | 1-Chloro-1,1-difluoroethane (Refrigerant gas R 142b)   | 8.9<br>7.8<br>7.0<br>7.0   | Allowed                     | Normal  | 0.99                         |     |
| 2602   | Dichlorodifluoromethane and difluoroethane azeotropic mixture with approximately 74% dichlorodifluoromethane (Refrigerant gas R 500) | 20.0<br>18.0<br>16.0<br>14.5   | Allowed                     | Normal  | 1.01                         |     |
| 3057   | Trifluoroacetyl chloride   | 14.6<br>12.9<br>11.3<br>9.9  | Not allowed                 | See 6.7.3.7.3   | 1.17                         |     |
| 3070   | Ethylene oxide and dichlorodifluoromethane mixture, with not more than 12.5% ethylene oxide  | 14.0<br>12.0<br>11.0<br>9.0  | Allowed                     | See 6.7.3.7.3   | 1.09                         |     |
| 3153   | Perfluoro(methyl vinyl ether)  | 14.3<br>13.4<br>11.2<br>10.2   | Allowed                     | Normal  | 1.14                         |     |
| 3159   | 1,1,1,2-Tetrafluoroethane (Refrigerant gas R 134a)   | 17.7<br>15.7<br>13.8<br>12.1   | Allowed                     | Normal  | 1.04                         |     |
| 3161   | Liquefied gas, flammable, N.O.S.   | See MAWP definition in 6.7.3.1   | Allowed                     | Normal  | See 4.2.2.7                  |     |
| 3163   | Liquefied gas, N.O.S.  | See MAWP definition in 6.7.3.1   | Allowed                     | Normal  | See 4.2.2.7                  |     |
| 3220   | Pentafluoroethane (Refrigerant gas R 125)  | 34.4<br>30.8<br>27.5<br>24.5   | Allowed                     | Normal  | 0.87                         |     |
| 3252   | Difluoromethane (Refrigerant gas R 32)   | 43.0<br>39.0<br>34.4<br>30.5   | Allowed                     | Normal  | 0.78                         |     |
| 3296   | Heptafluoropropane (Refrigerant gas R 227)   | 16.0<br>14.0<br>12.5<br>11.0   | Allowed                     | Normal  | 1.20                         |     |
| 3297   | Ethylene oxide and chlorotetrafluoroethane mixture, with not more than 8.8% ethylene oxide   | 8.1<br>7.0<br>7.0<br>7.0   | Allowed                     | Normal  | 1.16                         |     |
| 3298   | Ethylene oxide and pentafluoroethane mixture, with not more than 7.9% ethylene oxide   | 25.9<br>23.4<br>20.9<br>18.6   | Allowed                     | Normal  | 1.02                         |     |
| 3299   | Ethylene oxide and tetrafluoroethane mixture, with not more than 5.6% ethylene oxide   | 16.7<br>14.7<br>12.9<br>11.2   | Allowed                     | Normal  | 1.03                         |     |

<sup>a</sup>“Small” means tanks having a shell with a diameter of 1.5 metre or less; “Bare” means tanks having a shell with a diameter of more than 1.5 metre without insulation or sun shield (see 6.7.3.2.12); “Sunshield” means tanks having a shell with a diameter of more than 1.5 metre with sun shield (see 6.7.3.2.12); “Insulated” means tanks having a shell with a diameter of more than 1.5 metre with insulation (see 6.7.3.2.12); (see definition of “Design reference temperature” in 6.7.3.1).

<sup>b</sup> The word “Normal” in the pressure relief column indicates that a frangible disc as specified in 6.7.3.7.3 is not required.



Part 4 – Packing and tank provisions

| T50 PORTABLE TANK INSTRUCTION (continued) T50 |   |  |                             |   |                              |
|---|---|--|-----------------------------|---|------------------------------|
| UN No.  | Non-refrigerated liquefied gases  | Maximum allowable working pressure (bar) Small; Bare; Sunshield; Insulated respectively <sup>a</sup> | Openings below liquid level | Pressure relief provisions <sup>b</sup> (see 6.7.3.7) | Maximum filling ratio (kg/L) |
| 3318  | Ammonia solution, relative density less than 0.880 at 15°C in water, with more than 50% ammonia | See MAWP definition in 6.7.3.1   | Allowed                     | See 6.7.3.7.3   | See 4.2.2.7                  |
| 3337  | Refrigerant gas R 404A  | 31.6<br>28.3<br>25.3<br>22.5   | Allowed                     | Normal  | 0.82                         |
| 3338  | Refrigerant gas R 407A  | 31.3<br>28.1<br>25.1<br>22.4   | Allowed                     | Normal  | 0.94                         |
| 3339  | Refrigerant gas R 407B  | 33.0<br>29.6<br>26.5<br>23.6   | Allowed                     | Normal  | 0.93                         |
| 3340  | Refrigerant gas R 407C  | 29.9<br>26.8<br>23.9<br>21.3   | Allowed                     | Normal  | 0.95                         |
| 3500  | Chemical under pressure, n.o.s.   | See MAWP definition in 6.7.3.1   | Allowed                     | See 6.7.3.7.3   | TP4 <sup>c</sup>             |
| 3501  | Chemical under pressure, flammable, n.o.s.  | See MAWP definition in 6.7.3.1   | Allowed                     | See 6.7.3.7.3   | TP4 <sup>c</sup>             |
| 3502  | Chemical under pressure, toxic, n.o.s.  | See MAWP definition in 6.7.3.1   | Allowed                     | See 6.7.3.7.3   | TP4 <sup>c</sup>             |
| 3503  | Chemical under pressure, corrosive, n.o.s.  | See MAWP definition in 6.7.3.1   | Allowed                     | See 6.7.3.7.3   | TP4 <sup>c</sup>             |
| 3504  | Chemical under pressure, flammable, toxic, n.o.s.   | See MAWP definition in 6.7.3.1   | Allowed                     | See 6.7.3.7.3   | TP4 <sup>c</sup>             |
| 3505  | Chemical under pressure, flammable, corrosive, n.o.s.   | See MAWP definition in 6.7.3.1   | Allowed                     | See 6.7.3.7.3   | TP4 <sup>c</sup>             |

<sup>a</sup> “Small” means tanks having a shell with a diameter of 1.5 metre or less; “Bare” means tanks having a shell with a diameter of more than 1.5 metre without insulation or sun shield (see 6.7.3.2.12); “Sunshield” means tanks having a shell with a diameter of more than 1.5 metre with sun shield (see 6.7.3.2.12); “Insulated” means tanks having a shell with a diameter of more than 1.5 metre with insulation (see 6.7.3.2.12); (see definition of “Design reference temperature” in 6.7.3.1).

<sup>b</sup> The word “Normal” in the pressure relief column indicates that a frangible disc as specified in 6.7.3.7.3 is not required.

<sup>c</sup> For UN Nos. 3500, 3501, 3502, 3503, 3504 and 3505, the degree of filling shall be considered instead of the maximum filling ratio.

| T75 PORTABLE TANK INSTRUCTION T75   |  |
|---|--|
| This portable tank instruction applies to refrigerated liquefied gases. The general provisions of 4.2.3 and 6.7.4 shall be met. |  |

4.2.5.3 Portable tank special provisions

Portable tank special provisions are assigned to certain substances to indicate provisions which are in addition to or in lieu of those provided by the portable tank instructions or the provisions in chapter 6.7. Portable tank special provisions are identified by an alpha-numeric designation beginning with the letters “TP” (tank provision) and are assigned to specific substances in column 14 of the Dangerous Goods List in chapter 3.2. The following is a list of the portable tank special provisions:

- TP1 The degree of filling prescribed in 4.2.1.9.2 shall not be exceeded.
- TP2 The degree of filling prescribed in 4.2.1.9.3 shall not be exceeded.
- TP3 The maximum degree of filling (in %) for solids transported above their melting points and for elevated temperature liquids shall be determined in accordance with 4.2.1.9.5.
- TP4 The degree of filling shall not exceed 90% or, alternatively, any other value approved by the competent authority (see 4.2.1.16.2).

△ TP5 The restrictions on filling prescribed in 4.2.3.6 shall be met.



- TP6 To prevent the tank bursting in any event, including fire engulfment, it shall be provided with pressure-relief devices which are adequate in relation to the capacity of the tank and to the nature of the substance transported. The device shall also be compatible with the substance.
- TP7 Air shall be eliminated from the vapour space by nitrogen or other means.
- TP8 The test pressure for the portable tank may be reduced to 1.5 bar when the flashpoint of the substances transported is greater than 0°C.
- TP9 A substance under this description shall only be transported in a portable tank under an approval granted by the competent authority.
- TP10 A lead lining, not less than 5 mm thick, which shall be tested annually, or another suitable lining material approved by the competent authority is required. A portable tank may be offered for transport after the date of expiry of the last lining inspection for a period not to exceed three months beyond that date, after emptying but before cleaning, for purposes of performing the next required test or inspection prior to refilling.
- TP11 [Reserved]
- TP12 [Reserved]
- TP13 Self-contained breathing apparatus shall be provided when this substance is transported, unless no self-contained breathing apparatus, as required by SOLAS regulation II-2/19 (II-2/54), is on board.
- TP14 [Reserved]
- TP15 [Reserved]
- TP16 The tank shall be fitted with a special device to prevent under-pressure and excess pressure during normal transport conditions. This device shall be approved by the competent authority. Pressure-relief provisions are as indicated in 6.7.2.8.3 to prevent crystallization of the product in the pressure-relief valve.
- TP17 Only inorganic non-combustible materials shall be used for thermal insulation of the tank.
- TP18 Temperature shall be maintained between 18°C and 40°C. Portable tanks containing solidified methacrylic acid shall not be reheated during transport.
- TP19 At the time of construction, the minimum shell thickness determined according to 6.7.3.4 shall be increased by 3 mm as a corrosion allowance. Shell thickness shall be verified ultrasonically at intervals midway between periodic hydraulic tests and shall never be lower than the minimum shell thickness determined according to 6.7.3.4.
- TP20 This substance shall only be transported in insulated tanks under a nitrogen blanket.
- TP21 The shell thickness shall be not less than 8 mm. Tanks shall be hydraulically tested and internally inspected at intervals not exceeding 2.5 years.
- TP22 Lubricant for joints or other devices shall be oxygen-compatible.
- TP23 [Reserved]
- TP24 The portable tank may be fitted with a device located, under maximum filling conditions, in the vapour space of the shell to prevent the build-up of excess pressure due to the slow decomposition of the substance transported. This device shall also prevent an unacceptable amount of leakage of liquid in the case of overturning or entry of foreign matter into the tank. This device shall be approved by the competent authority or its authorized body.
- TP25 Sulphur trioxide 99.95% pure and above may be transported in tanks without an inhibitor provided that it is maintained at a temperature equal to or above 32.5°C.
- TP26 When transported under heated conditions, the heating device shall be fitted outside the shell. For UN 3176, this provision only applies when the substance reacts dangerously with water.
- TP27 A portable tank having a minimum test pressure of 4 bar may be used if it is shown that a test pressure of 4 bar or less is acceptable according to the test pressure definition in 6.7.2.1.
- TP28 A portable tank having a minimum test pressure of 2.65 bar may be used if it is shown that a test pressure of 2.65 bar or less is acceptable according to the test pressure definition in 6.7.2.1.
- TP29 A portable tank having a minimum test pressure of 1.5 bar may be used if it is shown that a test pressure of 1.5 bar or less is acceptable according to the test pressure definition in 6.7.2.1.
- TP30 This substance shall be transported in insulated tanks.
- TP31 This substance shall be transported in tanks in solid state.
- TP32 For UN Nos. 0331, 0332 and 3375, portable tanks may be used subject to the following conditions:
- .1 To avoid unnecessary confinement, each portable tank constructed of metal or fibre-reinforced plastics shall be fitted with a pressure relief device that may be of the re-closing spring-loaded type, a frangible disc or a fusible element. The set-to-discharge or burst pressure, as applicable,

**Part 4 – Packing and tank provisions**

- shall not be greater than 2.65 bar for portable tanks with minimum test pressures greater than 4 bar.
- .2 For UN 3375 only, suitability for transport in tanks shall be demonstrated. One method to evaluate this suitability is test 8 (d) in Test Series 8 (see *Manual of Tests and Criteria*, part 1, subsection 18.7).
- .3 Substances shall not be allowed to remain in the portable tank for any period that could result in caking. Appropriate measures shall be taken to avoid accumulation and packing of substances in the tank (e.g. cleaning, etc).
- TP33 The portable tank instruction assigned for this substance applies for granular and powdered solids and for solids which are filled and discharged at temperatures above their melting point and which are cooled and transported as a solid mass. For solids which are transported above their melting point, see 4.2.1.19.
- TP34 Portable tanks need not be subjected to the impact test in 6.7.4.14.1 if the portable tank is marked “NOT FOR RAIL TRANSPORT” on the plate specified in 6.7.4.15.1 and also in letters at least 10 cm high on both sides of the outer jacket.
- TP35 *Deleted*
- TP36 Fusible elements in the vapour space may be used on portable tanks.
- TP37 *Deleted*
- TP38 *Deleted*
- TP39 *Deleted*
- TP40 Portable tanks shall not be transported when connected with spray application equipment.
- TP41 The 2.5-year internal examination may be waived or substituted by other test methods or inspection procedures specified by the competent authority or its authorized body, provided that the portable tank is dedicated to the transport of the organometallic substances to which this tank special provision is assigned. However, this examination is required when the conditions of 6.7.2.19.7 are met.
- TP42 Portable tanks are not authorized for the transport of caesium or rubidium dispersions.
- TP90 Tanks with bottom openings may be used on short international voyages.
- TP91 Portable tanks with bottom openings may also be used on long international voyages.

**4.2.6 Additional provisions for the use of road tank vehicles and road gas elements vehicles**

- 4.2.6.1 The tank of a road tank vehicle or the elements of a road gas elements vehicle shall be attached to the vehicle during normal operations of filling, discharge and transport. IMO type 4 tanks shall be attached to the chassis when transported on board ships. Road tank vehicles and road gas elements vehicles shall not be filled or discharged while they remain on board. A road tank vehicle or road gas elements vehicle shall be driven on board on its own wheels and be fitted with permanent tie-down attachments for securing on board the ship.
- 4.2.6.2 Road tank vehicles and road gas elements vehicles shall comply with the provisions of chapter 6.8. IMO type 4, 6, 8 and 9 tanks may be used according to the provisions of chapter 6.8 for short international voyages only.
- 4.2.6.3 Substances permitted to be transported in IMO type 9 tanks are assigned special provision 974.

## Chapter 4.3

### *Use of bulk containers*

**Note:** Sheeted bulk containers (BK1) shall not be used for sea transport, except as indicated in 4.3.3.

#### 4.3.1 General provisions

4.3.1.1 This section provides general requirements applicable to the use of containers for the transport of solid substances in bulk. Substances shall be transported in bulk containers conforming to the applicable bulk container instruction identified by the letters BK in column 13 of the Dangerous Goods List, with the following meaning:

BK1: the transport in sheeted bulk containers is permitted;

BK2: the transport in closed bulk containers is permitted;

BK3: the transport in flexible bulk containers is permitted.

The bulk container used shall conform to the provisions of chapter 6.9.

4.3.1.2 Except as provided in 4.3.1.3, bulk containers shall only be used when a substance is assigned a bulk container code in column 13 of the Dangerous Goods List.

4.3.1.3 When a substance is not assigned BK2 or BK3 in column 13 of the Dangerous Goods List, interim approval for transport may be issued by the competent authority of the country of origin. The approval shall be included in the documentation of the consignment and contain, as a minimum, the information normally provided in the bulk container instruction and the conditions under which the substance shall be transported. Appropriate measures should be initiated by the competent authority to have the assignment included in the Dangerous Goods List. When a substance is not permitted in a BK1 bulk container, an exemption may be issued in accordance with 7.9.1.

4.3.1.4 Substances which may become liquid at temperatures likely to be encountered during transport are not permitted in bulk containers.

4.3.1.5 Bulk containers shall be siftproof and shall be so closed that none of the contents can escape under normal conditions of transport, including the effect of vibration, or by changes of temperature, humidity or pressure.

4.3.1.6 Bulk solids shall be loaded into bulk containers and evenly distributed in a manner that minimizes movement that could result in damage to the container or leakage of the dangerous goods.

4.3.1.7 Where venting devices are fitted, they shall be kept clear and operable.

4.3.1.8 Bulk solids shall not react dangerously with the material of the bulk container, gaskets, equipment including lids and tarpaulins, or with protective coatings which are in contact with the contents, or significantly weaken them. Bulk containers shall be so constructed or adapted that the goods cannot penetrate between wooden floor coverings or come into contact with those parts of the bulk containers that may be affected by the dangerous goods or residues thereof.

4.3.1.9 Before being filled and offered for transport, each bulk container shall be inspected and cleaned to ensure that it does not contain any residue on the interior or exterior that could:

- cause a dangerous reaction with the substance intended for transport;
- detrimentally affect the structural integrity of the bulk container; or
- affect the dangerous goods retention capabilities of the bulk container.

4.3.1.10 During transport, no dangerous residues shall adhere to the outer surfaces of a bulk container.

4.3.1.11 If several closure systems are fitted in series, the system which is located nearest to the dangerous goods to be transported shall be closed first before filling.

4.3.1.12 Empty bulk containers that have contained dangerous goods shall be treated in the same manner as is prescribed in this Code for a filled bulk container, unless adequate measures have been taken to nullify any hazard.

**Part 4 – Packing and tank provisions**

- 4.3.1.13** If bulk containers are used for the carriage of bulk goods liable to cause a dust explosion, or evolve flammable vapours (e.g. for certain wastes), measures shall be taken to exclude sources of ignition and to prevent dangerous electrostatic discharge during transport, loading or unloading of the goods.
- 4.3.1.14** Substances, for example wastes, which may react dangerously with one another and substances of different classes and goods not subject to this Code, which are liable to react dangerously with one another, shall not be mixed together in the same bulk container. Dangerous reactions are:
- .1 combustion and/or evolution of considerable heat;
  - .2 emission of flammable and/or toxic gases;
  - .3 formation of corrosive liquids; or
  - .4 formation of unstable substances.
- 4.3.1.15** Before a bulk container is filled, it shall be visually examined to ensure it is structurally serviceable, its interior walls, ceiling and floors are free from protrusions or damage and that any inner liners or substance retaining equipment are free from rips, tears or any damage that would compromise its cargo retention capabilities. "Structurally serviceable" means the bulk container does not have major defects in its structural components, such as top and bottom side rails, top and bottom end rails, door sill and header, floor cross members, corner posts, and corner fittings in a freight container. Major defects include:
- .1 bends, cracks or breaks in the structural or supporting members that affect the integrity of the container;
  - .2 more than one splice or an improper splice (such as a lapped splice) in top or bottom end rails or door headers;
  - .3 more than two splices in any one top or bottom side rail;
  - .4 any splice in a door sill or corner post;
  - .5 door hinges and hardware that are seized, twisted, broken, missing, or otherwise inoperative;
  - .6 gaskets and seals that do not seal;
  - .7 any distortion of the overall configuration great enough to prevent proper alignment of handling equipment, mounting and securing chassis or vehicle, or insertion into ships' cargo spaces;
  - .8 any damage to lifting attachments or handling equipment interface features; or
  - .9 any damage to service or operational equipment.
- 4.3.1.16** Before a flexible bulk container is filled it shall be visually examined to ensure it is structurally serviceable, its textile slings, load-bearing structure straps, body fabric, lock device parts including metal and textile parts are free from protrusions or damage and that inner liners are free from rips, tears or any damage.
- 4.3.1.16.1** For flexible bulk containers, the period of use permitted for the transport of dangerous goods shall be two years from the date of manufacture of the flexible bulk container.
- 4.3.1.16.2** A venting device shall be fitted if a dangerous accumulation of gases may develop within the flexible bulk container. The vent shall be so designed that the penetration of foreign substances or the ingress of water is prevented under normal conditions of transport.
- 4.3.2 Additional provisions applicable to bulk goods of classes 4.2, 4.3, 5.1, 6.2, 7 and 8**
- 4.3.2.1 Bulk goods of class 4.2**
- Only closed bulk containers (BK2) may be used. The total mass carried in a bulk container shall be such that its spontaneous ignition temperature is greater than 55°C.
- 4.3.2.2 Bulk goods of class 4.3**
- Only closed bulk containers (BK2) may be used. These goods shall be transported in bulk containers which are waterproof.
- 4.3.2.3 Bulk goods of class 5.1**
- Bulk containers shall be so constructed or adapted that the goods cannot come into contact with wood or any other incompatible material.

#### 4.3.2.4 Bulk goods of class 6.2

##### 4.3.2.4.1 *Transport in bulk containers of animal material of class 6.2*

Animal material containing infectious substances (UN Nos. 2814, 2900 and 3373) is authorized for transport in bulk containers provided the following conditions are met:

- .1 Closed bulk containers, and their openings, shall be leakproof by design or by the fitting of a suitable liner.
- .2 The animal material shall be thoroughly treated with an appropriate disinfectant before loading prior to transport.
- .3 Closed bulk containers shall not be re-used until they have been thoroughly cleaned and disinfected.

**Note:** Additional provisions may be required by appropriate national health authorities.

##### 4.3.2.4.2 *Bulk wastes of class 6.2 (UN 3291)*

- .1 only closed bulk containers (BK2) shall be permitted;
- .2 closed bulk containers, and their openings, shall be leakproof by design. These bulk containers shall have non-porous interior surfaces and shall be free from cracks or other features that could damage packagings inside, impede disinfection or permit inadvertent release;
- .3 wastes of UN 3291 shall be contained within the closed bulk container in UN type tested and approved sealed leakproof plastics bags tested for solids of packing group II and marked in accordance with 6.1.3.1. Such plastics bags shall be capable of passing the tests for tear and impact resistance according to ISO 7765-1:1988, *Plastics film and sheeting – Determination of impact resistance by the free-falling dart method – Part 1: Staircase methods*, and ISO 6383-2:1983, *Plastics – Film and sheeting – Determination of tear resistance – Part 2: Elmendorf method*. Each bag shall have an impact resistance of at least 165 g and a tear resistance of at least 480 g in both parallel and perpendicular planes with respect to the length of the bag. The maximum net mass of each plastics bag shall be 30 kg;
- .4 single articles exceeding 30 kg such as soiled mattresses may be transported without the need for a plastics bag when authorized by the competent authority;
- .5 wastes of UN 3291 which contain liquids shall only be transported in plastics bags containing sufficient absorbent material to absorb the entire amount of liquid without it spilling in the bulk container;
- .6 wastes of UN 3291 containing sharp objects shall only be transported in UN type tested and approved rigid packagings meeting the provisions of packing instructions P621, IBC620 or LP621;
- .7 rigid packagings specified in packing instructions P621, IBC620 or LP621 may also be used. They shall be properly secured to prevent damage during normal conditions of transport. Wastes transported in rigid packagings and plastics bags together in the same closed bulk container shall be adequately segregated from each other, e.g. by suitable rigid barriers or dividers, mesh nets or otherwise securing the packagings, such that they prevent damage to the packagings during normal conditions of transport;
- .8 wastes of UN 3291 in plastics bags shall not be compressed in a closed bulk container in such a way that bags may be rendered no longer leakproof;
- .9 the closed bulk container shall be inspected for leakage or spillage after each journey. If any wastes of UN 3291 have leaked or been spilled in the closed bulk container, it shall not be re-used until after it has been thoroughly cleaned and, if necessary, disinfected or decontaminated with an appropriate agent. No other goods shall be transported together with UN 3291 other than medical or veterinary wastes. Any such other wastes transported in the same closed bulk container shall be inspected for possible contamination.

#### 4.3.2.5 Bulk material of class 7

For the transport of unpackaged radioactive material, see 4.1.9.2.4.

#### 4.3.2.6 Bulk goods of class 8

Only closed bulk containers (BK2) may be used. These goods shall be transported in bulk containers which are watertight.

### 4.3.3 Additional provisions for the use of sheeted bulk containers (BK1)

4.3.3.1 Sheeted bulk containers (BK1) shall not be used for sea transport, except for UN 3077 not meeting the criteria of 2.9.3 transported on short international voyages.

### 4.3.4 Additional provisions for the use of flexible bulk containers (BK3)

4.3.4.1 Flexible bulk containers are only allowed in the holds of general cargo ships. They are not allowed to be transported in cargo transport units.



# **PART 5**

## **CONSIGNMENT PROCEDURES**





# Chapter 5.1

## *General provisions*

### 5.1.1 Application and general provisions

5.1.1.1 This part sets forth the provisions for dangerous goods consignments relative to authorization of consignments and advance notifications, marking, labelling, documentation (by manual, electronic data processing (EDP) or electronic data interchange (EDI) techniques) and placarding.

5.1.1.2 Except as otherwise provided in this Code, no person may offer dangerous goods for transport unless those goods are properly marked, labelled, placarded, described and certified on a transport document, and otherwise in a condition for transport as required by this part.

**Note:** In accordance with the GHS, a GHS pictogram not required by this Code should only appear in transport as part of a complete GHS label and not independently (see GHS 1.4.10.4.4).

5.1.1.3 A carrier shall not accept dangerous goods for transport unless:

- .1 A copy of the dangerous goods transport document and other documents or information as required by the provisions of this Code are provided; or
- .2 The information applicable to the dangerous goods is provided in electronic form.

5.1.1.4 The information applicable to the dangerous goods shall accompany the dangerous goods to final destination. This information may be on the dangerous goods transport document or may be on another document. This information shall be given to the consignee when the dangerous goods are delivered.

5.1.1.5 When the information applicable to the dangerous goods is given to the carrier in electronic form, the information shall be available to the carrier at all times during transport to final destination. The information shall be able to be produced without delay as a paper document.

5.1.1.6 The purpose of indicating the proper shipping name (see 3.1.2.1 and 3.1.2.2) and the UN number of a substance, material or article offered for transport and, in the case of a marine pollutant, of the addition of "marine pollutant" on documentation accompanying the consignment, and of marking the proper shipping name in accordance with 5.2.1 on the package, including IBCs containing the goods, is to ensure that the substance, material or article can be readily identified during transport. This ready identification is particularly important in the case of an accident involving these goods, in order to determine what emergency procedures are necessary to deal properly with the situation and, in the case of marine pollutants, for the master to comply with the reporting requirements of Protocol I of MARPOL.

### 5.1.2 Use of overpacks and unit loads

5.1.2.1 An overpack and unit load shall be marked with the proper shipping name and the UN number and marked and labelled, as required for packages by chapter 5.2, for each item of dangerous goods contained in the overpack or unit load unless marks and labels representative of all dangerous goods in the overpack or unit load are visible. An overpack, in addition, shall be marked with the word "OVERPACK" unless marks and labels representative of all dangerous goods, as required by chapter 5.2, in the overpack are visible. Labelling of overpacks containing radioactive materials shall be in accordance with 5.2.2.1.12. The lettering of the "OVERPACK" mark shall be at least 12 mm high.

5.1.2.2 The individual packages comprising a unit load or an overpack shall be marked and labelled in accordance with chapter 5.2. Each package of dangerous goods contained in the unit load or overpack shall comply with all applicable provisions of the Code. The "OVERPACK" mark on an overpack is an indication of compliance with this provision. The intended function of each package shall not be impaired by the unit load or overpack.

5.1.2.3 Each package bearing package orientation marks as prescribed in 5.2.1.7.1 of this Code and which is overpacked, placed in a unit load or used as an inner packaging in a large packaging shall be oriented in accordance with such marks.

**Part 5 – Consignment procedures****5.1.3 Empty uncleaned packagings or units**

5.1.3.1 Other than for class 7, a packaging, including an IBC, which previously contained dangerous goods shall be identified, marked, labelled and placarded as required for those dangerous goods unless steps such as cleaning, purging of vapours or refilling with a non-dangerous substance are taken to nullify any hazard.

5.1.3.2 Freight containers, tanks, IBCs, as well as other packagings and overpacks, used for the transport of radioactive material shall not be used for the transport of other goods unless decontaminated below the level of 0.4 Bq/cm<sup>2</sup> for beta and gamma emitters and low-toxicity alpha emitters and 0.04 Bq/cm<sup>2</sup> for all other alpha emitters.

5.1.3.3 Empty cargo transport units still containing residues of dangerous goods, or loaded with empty uncleaned packages or empty uncleaned bulk containers, shall comply with the provisions applicable to the goods last contained in the unit, packagings or bulk container.

**5.1.4 Mixed packing**

When two or more dangerous goods are packed within the same outer packaging, the package shall be labelled and marked as required for each substance. Subsidiary hazard labels need not be applied if the hazard is already represented by a primary hazard label.

**5.1.5 General provisions for class 7****5.1.5.1 Approval of shipments and notification****5.1.5.1.1 General**

In addition to the approval of package designs described in chapter 6.4, multilateral shipment approval is also required in certain circumstances (5.1.5.1.2 and 5.1.5.1.3). In some circumstances it is also necessary to notify competent authorities of a shipment (5.1.5.1.4).

**5.1.5.1.2 Shipment approvals**

Multilateral approval shall be required for:

- .1 the shipment of Type B(M) packages not conforming with the provisions of 6.4.7.5 or designed to allow controlled intermittent venting;
- .2 the shipment of Type B(M) packages containing radioactive material with an activity greater than 3,000A<sub>1</sub> or 3,000A<sub>2</sub>, as appropriate, or 1,000 TBq, whichever is the lower;
- .3 the shipment of packages containing fissile materials if the sum of the criticality safety indexes of the packages in a single freight container or in a single conveyance exceeds 50. Excluded from this requirement shall be shipments by seagoing vessels, if the sum of the criticality safety indexes does not exceed 50 for any hold, compartment or defined deck area and the distance of 6 m between groups of packages or overpacks as required in the table in 7.1.4.5.3.4 is met;
- .4 radiation protection programmes for shipments by special use vessels in accordance with 7.1.4.5.8; and
- .5 the shipment of SCO-III.

except that a competent authority may authorize transport into or through its country without shipment approval, by a specific provision in its design approval (see 5.1.5.2.1).

**5.1.5.1.3 Shipment approval by special arrangement**

A competent authority may approve provisions under which consignments that do not satisfy all the applicable requirements of this Code may be transported under special arrangement (see 1.5.4).

**5.1.5.1.4 Notifications**

Notification to competent authorities is required as follows:

- .1 Before the first shipment of any package requiring competent authority approval, the consignor shall ensure that copies of each applicable competent authority certificate applying to that package design have been submitted to the competent authority of the country of origin of the shipment and to the competent authority of each country through or into which the consignment is to be transported. The consignor is not required to await an acknowledgement from the competent authority, nor is the competent authority required to make such acknowledgement of receipt of the certificate.

- .2 For each of the following types of shipments:
  - .1 Type C packages containing radioactive material with an activity greater than  $3,000A_1$  or  $3,000A_2$ , as appropriate, or 1,000 TBq, whichever is the lower;
  - .2 Type B(U) packages containing radioactive material with an activity greater than  $3,000A_1$  or  $3,000A_2$ , as appropriate, or 1,000 TBq, whichever is the lower;
  - .3 Type B(M) packages;
  - .4 shipment under special arrangement;

the consignor shall notify the competent authority of the country of origin of the shipment and the competent authority of each country through or into which the consignment is to be transported. This notification shall be in the possession of each competent authority prior to the commencement of the shipment, and preferably at least 7 days in advance.
- .3 The consignor is not required to send a separate notification if the required information has been included in the application for approval of shipment (see 6.4.23.2).
- .4 The consignment notification shall include:
  - .1 sufficient information to enable the identification of the package or packages, including all applicable certificate numbers and identification marks;
  - .2 information on the date of shipment, the expected date of arrival and proposed routeing;
  - .3 the names of the radioactive material or nuclides;
  - .4 descriptions of the physical and chemical forms of the radioactive material, or whether it is special form radioactive material or low dispersible radioactive material; and
  - .5 the maximum activity of the radioactive contents during transport, expressed in units of becquerels (Bq) with an appropriate SI prefix symbol (see 1.2.2.1). For fissile material, the mass of fissile material (or of each fissile nuclide for mixtures when appropriate) in units of grams (g), or multiples thereof, may be used in place of activity.

#### 5.1.5.2 Certificates issued by competent authority

5.1.5.2.1 Certificates issued by the competent authority are required for the following:

- .1 designs for:
  - .1 special form radioactive material;
  - .2 low dispersible radioactive material;
  - .3 fissile material excepted under 2.7.2.3.5.6;
  - .4 packages containing 0.1 kg or more of uranium hexafluoride;
  - .5 packages containing fissile material unless excepted by 2.7.2.3.5, 6.4.11.2 or 6.4.11.3;
  - .6 Type B(U) packages and Type B(M) packages;
  - .7 Type C packages;
- .2 special arrangements;
- .3 certain shipments (see 5.1.5.1.2);
- .4 determination of the basic radionuclide values referred to in 2.7.2.2.1 for individual radionuclides which are not listed in table 2.7.2.2.1 (see 2.7.2.2.2.1);
- .5 alternative activity limits for an exempt consignment of instruments or articles (see 2.7.2.2.2.2).

The certificates shall confirm that the applicable provisions are met, and for design approvals shall attribute to the design an identification mark.

The certificates of approval for the package design and the shipment may be combined into a single certificate.

Certificates and applications for these certificates shall be in accordance with the provisions in 6.4.23.

5.1.5.2.2 The consignor shall be in possession of a copy of each applicable certificate.

5.1.5.2.3 For package designs where it is not required that a competent authority issue a certificate of approval, the consignor shall, on request, make available, for inspection by the relevant competent authority, documentary evidence of the compliance of the package design with all the applicable provisions.

#### 5.1.5.3 Determination of transport index (TI) and criticality safety index (CSI)

5.1.5.3.1 The transport index (TI) for a package, overpack or freight container, or for unpackaged LSA-I, SCO-I or SCO-III, shall be the number derived in accordance with the following procedure:

- .1 determine the dose rate in units of millisieverts per hour (mSv/h) at a distance of 1 m from the external surfaces of the package, overpack, freight container, or unpackaged LSA-I, SCO-I or SCO III. The value

Part 5 – Consignment procedures

determined shall be multiplied by 100 and the resulting number is the transport index. For uranium and thorium ores and their concentrates, the maximum dose rate at any point 1 m from the external surface of the load may be taken as:

- 0.4 mSv/h for ores and physical concentrates of uranium and thorium;
  - 0.3 mSv/h for chemical concentrates of thorium;
  - 0.02 mSv/h for chemical concentrates of uranium, other than uranium hexafluoride;
- .2 for tanks, freight containers and unpackaged LSA-I, SCO-I and SCO-III, the value determined in 5.1.5.3.1.1 above shall be multiplied by the appropriate factor from table 5.1.5.3.1;
- .3 the value obtained in 5.1.5.3.1.1 and 5.1.5.3.1.2 above shall be rounded up to the first decimal place (e.g. 1.13 becomes 1.2), except that a value of 0.05 or less may be considered as zero and the resulting number is the TI value (without unit).

**Table 5.1.5.3.1 – Multiplication factors for tanks, freight containers and unpackaged LSA-I, SCO-I and SCO-III**

| Size of load <sup>a</sup>                           | Multiplication factor |
|---|-----------------------|
| size of load ≤ 1 m <sup>2</sup>                     | 1                     |
| 1 m <sup>2</sup> < size of load ≤ 5 m <sup>2</sup>  | 2                     |
| 5 m <sup>2</sup> < size of load ≤ 20 m <sup>2</sup> | 3                     |
| 20 m <sup>2</sup> < size of load                    | 10                    |

<sup>a</sup> Largest cross-sectional area of the load being measured.

5.1.5.3.2 The TI for each rigid overpack, freight container or conveyance shall be determined as the sum of the TIs of all the packages contained therein. For a shipment from a single consignor, the consignor may determine the TI by direct measurement of dose rate.

The TI for a non-rigid overpack shall be determined only as the sum of the TIs of all the packages within the overpack.

5.1.5.3.3 The criticality safety index for each overpack or freight container shall be determined as the sum of the CSIs of all the packages contained. The same procedure shall be followed for determining the total sum of the CSIs in a consignment or aboard a conveyance.

5.1.5.3.4 Packages, overpacks and freight containers shall be assigned to either category I – WHITE, II – YELLOW or III – YELLOW in accordance with the conditions specified in table 5.1.5.3.4 and with the following requirements:

- .1 for a package, overpack or freight container, both the transport index and the surface dose rate conditions shall be taken into account in determining which is the appropriate category. Where the transport index satisfies the condition for one category but the surface dose rate satisfies the condition for a different category, the package, overpack or freight container shall be assigned to the higher category. For this purpose, category I – WHITE shall be regarded as the lowest category;
- .2 the TI shall be determined following the procedures specified in 5.1.5.3.1 and 5.1.5.3.2;
- .3 if the surface dose rate is greater than 2 mSv/h, the package or overpack shall be transported under exclusive use and under the provisions of 7.1.4.5.6 or 7.1.4.5.7, as appropriate;
- .4 a package transported under a special arrangement shall be assigned to category III – YELLOW except under the provisions of 5.1.5.3.5;
- .5 an overpack or freight container which contains packages transported under special arrangement shall be assigned to category III – YELLOW except under the provisions of 5.1.5.3.5.



Table 5.1.5.3.4 – Categories of packages, overpacks and freight containers

| Conditions                                   |  |                           |
|--|--|---------------------------|
| Transport index                              | Maximum dose rate at any point on external surface | Category                  |
| 0 <sup>a</sup>                               | Not more than 0.005 mSv/h                          | I – WHITE                 |
| More than 0 but not more than 1 <sup>a</sup> | More than 0.005 mSv/h but not more than 0.5 mSv/h  | II – YELLOW               |
| More than 1 but not more than 10             | More than 0.5 mSv/h but not more than 2 mSv/h      | III – YELLOW              |
| More than 10                                 | More than 2 mSv/h but not more than 10 mSv/h       | III – YELLOW <sup>b</sup> |

<sup>a</sup> If the measured TI is not greater than 0.05, the value quoted may be zero in accordance with 5.1.5.3.1.3.

<sup>b</sup> Shall also be transported under “exclusive use” except for freight containers (see the table in 7.1.4.5.3.1).

**5.1.5.3.5** In all cases of international transport of packages requiring competent authority approval of design or shipment, for which different approval types apply in the different countries concerned by the shipment, the categorization shall be in accordance with the certificate of the country of origin of design.

#### **5.1.5.4 Specific provisions for excepted packages of radioactive material of class 7**

**5.1.5.4.1** Excepted packages of radioactive material of class 7 shall be legibly and durably marked on the outside of the packaging with:

- .1 the UN number preceded by the letters “UN”;
- .2 an identification of either the consignor or consignee, or both; and
- .3 the permissible gross mass if this exceeds 50 kg.

**5.1.5.4.2** The documentation requirements of 5.4.1 and 5.4.5 do not apply to excepted packages of radioactive material of class 7, except that:

- .1 the UN number preceded by the letters “UN” and the name and address of the consignor and the consignee and, if relevant, the identification mark for each competent authority certificate of approval (see 5.4.1.5.7.1.7) shall be shown on a special transport document such as a bill of lading, air waybill or other similar document complying with the requirements of 5.4.1.2.1 to 5.4.1.2.4; and
- .2 the requirements of 5.4.1.6.2 and, if relevant, those of 5.4.1.5.7.1.7, 5.4.1.5.7.3 and 5.4.1.5.7.4 shall apply.

**5.1.5.4.3** The requirements of 5.2.1.5.8 and 5.2.2.1.12.5 shall apply if relevant.

#### **5.1.5.5 Specific provisions for the consignment of fissile material**

Fissile material meeting one of the provisions of 2.7.2.3.5.1 to 2.7.2.3.5.6 shall meet the following requirements:

- .1 only one of the provisions of 2.7.2.3.5.1 to 2.7.2.3.5.6 is allowed per consignment;
- .2 only one approved fissile material in packages classified in accordance with 2.7.2.3.5.6 is allowed per consignment unless multiple materials are authorized in the certificate of approval;
- .3 fissile material in packages classified in accordance with 2.7.2.3.5.3 shall be transported in a consignment with no more than 45 g of fissile nuclides;
- .4 fissile material in packages classified in accordance with 2.7.2.3.5.4 shall be transported in a consignment with no more than 15 g of fissile nuclides;
- .5 unpackaged or packaged fissile material classified in accordance with 2.7.2.3.5.5 shall be transported under exclusive use on a conveyance with no more than 45 g of fissile nuclides.

#### **5.1.6 Packages packed into a cargo transport unit**

**5.1.6.1** Regardless of the placarding and marking provisions for cargo transport units, each package containing dangerous goods packed into a cargo transport unit shall be marked and labelled in accordance with the requirements of chapter 5.2.

## Chapter 5.2

### Marking and labelling of packages including IBCs

**Note:** These provisions relate essentially to the marking and labelling of dangerous goods according to their properties. However, additional marks or symbols indicating precautions to be taken in handling or storing a package (such as a symbol representing an umbrella, indicating that a package shall be kept dry) may be displayed on a package if appropriate.

#### 5.2.1 Marking of packages including IBCs

**5.2.1.1** Unless provided otherwise in this Code, the proper shipping name for the dangerous goods as determined in accordance with 3.1.2 and the corresponding UN number, preceded by the letters "UN", shall be displayed on each package. The UN number and the letters "UN" shall be at least 12 mm high, except for packages of 30 L capacity or less or of 30 kg maximum net mass or less and for cylinders of 60 L water capacity or less when they shall be at least 6 mm in height and except for packages of 5 L capacity or less or of 5 kg maximum net mass when they shall be of an appropriate size. In the case of unpackaged articles, the mark shall be displayed on the article, on its cradle or on its handling, storage or launching device. For goods of division 1.4, compatibility group S, the division and compatibility group letter shall also be marked unless the label for 1.4S is displayed. A typical package mark is:

CORROSIVE LIQUID, ACIDIC, ORGANIC, N.O.S. (caprylyl chloride) UN 3265.

**Note:** Cylinders of 60 L water capacity or less marked with a UN number in accordance with the provisions of the IMDG Code up to 31 December 2013 and which do not conform to the provisions of 5.2.1.1 regarding the size of the UN number and of the letters "UN" applicable as from 1 January 2014 may continue to be used until the next periodic inspection but no later than 1 July 2018.

**5.2.1.2** All package marks required by 5.2.1.1:

- .1 shall be readily visible and legible;
- .2 shall be such that this information will still be identifiable on packages surviving at least three months' immersion in the sea. In considering suitable marking methods, account shall be taken of the durability of the packaging materials used and the surface of the package;
- .3 shall be displayed on a background of contrasting colour on the external surface of the package; and
- .4 shall not be located with other package marks that could substantially reduce their effectiveness.

**5.2.1.3** Salvage packagings including large salvage packagings and salvage pressure receptacles shall additionally be marked with the word "SALVAGE". The lettering of the "SALVAGE" mark shall be at least 12 mm high.

**5.2.1.4** Intermediate bulk containers of more than 450 L capacity and large packagings shall be marked on two opposing sides.

#### 5.2.1.5 Special marking provisions for radioactive material

**5.2.1.5.1** Each package shall be legibly and durably marked on the outside of the packaging with an identification of either the consignor or consignee, or both. Each overpack shall be legibly and durably marked on the outside of the overpack with an identification of either the consignor or consignee, or both unless these marks of all packages within the overpack are clearly visible.

**5.2.1.5.2** The marking of excepted packages of radioactive material of class 7 shall be as required by 5.1.5.4.1.

**5.2.1.5.3** Each package of gross mass exceeding 50 kg shall have its permissible gross mass legibly and durably marked on the outside of the packaging.

**5.2.1.5.4** Each package which conforms to:

- .1 a Type IP-1 package, a Type IP-2 package or a Type IP-3 package design shall be legibly and durably marked on the outside of the packaging with "TYPE IP-1", "TYPE IP-2" or "TYPE IP-3" as appropriate;



- .2 a Type A package design shall be legibly and durably marked on the outside of the packaging with "TYPE A";
- .3 a Type IP-2 package, a Type IP-3 package or a Type A package design shall be legibly and durably marked on the outside of the packaging with the international vehicle registration code (VRI code) of the country of origin of design and either the name of the manufacturer or other identification of the packaging specified by the competent authority of the country of origin of design.

5.2.1.5.5 Each package which conforms to a design approved under one or more of paragraphs 5.1.5.2.1, 6.4.22.1 to 6.4.22.4, 6.4.23.4 to 6.4.23.7 and 6.4.24.2 shall be legibly and durably marked on the outside of the package with the following information:

- .1 the identification mark allocated to that design by the competent authority;
- .2 a serial number to uniquely identify each packaging which conforms to that design;
- .3 "Type B(U)", "Type B(M)" or "Type C", in the case of a Type B(U), Type B(M) or Type C package design.

5.2.1.5.6 Each package which conforms to a Type B(U), Type B(M) or Type C package design shall have the outside of the outermost receptacle which is resistant to the effects of fire and water plainly marked by embossing, stamping or other means resistant to the effects of fire and water with the trefoil symbol shown below.

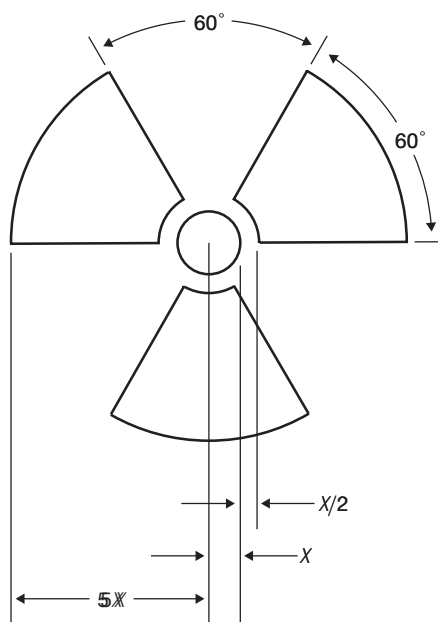

**Basic trefoil symbol with proportions based on a central circle of radius X.  
The minimum allowable size of X shall be 4 mm.**

Any mark on the package made in accordance with the requirements of 5.2.1.5.4.1 and .2 and 5.2.1.5.5.3 relating to the package type that does not relate to the UN number and proper shipping name assigned to the consignment shall be removed or covered.

- 5.2.1.5.7 Where LSA-I or SCO-I material is contained in receptacles or wrapping materials and is transported under exclusive use as permitted by 4.1.9.2.4, the outer surface of these receptacles or wrapping materials may bear the mark "RADIOACTIVE LSA-I" or "RADIOACTIVE SCO-I", as appropriate.
- 5.2.1.5.8 In all cases of international transport of packages requiring competent authority approval of design or shipment, for which different approval types apply in the different countries concerned by the shipment, marking shall be in accordance with the certificate of the country of origin of the design.
- 5.2.1.6 **Special marking provisions for marine pollutants**
  - 5.2.1.6.1 Except as provided in 2.10.2.7, packages containing marine pollutants meeting the criteria of 2.9.3 shall be durably marked with the marine pollutant mark.
  - 5.2.1.6.2 The marine pollutant mark shall be located adjacent to the marks required by 5.2.1.1. The provisions of 5.2.1.2 and 5.2.1.4 shall be met.



Part 5 – Consignment procedures

5.2.1.6.3 The marine pollutant mark shall be as shown in the figure below.

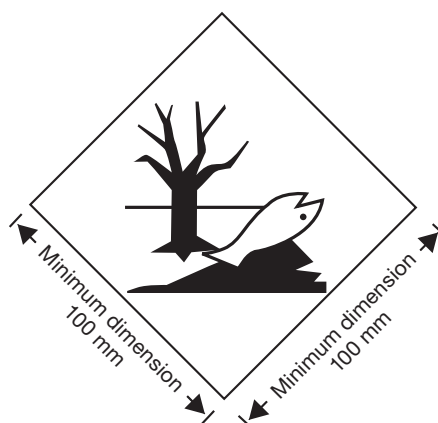

Marine pollutant mark

The mark shall be in the form of a square set at an angle of 45° (diamond-shaped). The symbol (fish and tree) shall be black on white or a suitable contrasting background. The minimum dimensions shall be 100 mm × 100 mm and the minimum width of line forming the diamond shall be 2 mm. If the size of the package so requires, the dimensions/line thickness may be reduced, provided the mark remains clearly visible. Where dimensions are not specified, all features shall be in approximate proportion to those shown.

**Note:** The labelling provisions of 5.2.2 apply in addition to any requirement for packages to bear the marine pollutant mark.

5.2.1.7 Orientation arrows

5.2.1.7.1 Except as provided in 5.2.1.7.2:

- combination packagings having inner packagings containing liquid dangerous goods;
- single packagings fitted with vents;
- closed or open cryogenic receptacles intended for the transport of refrigerated liquefied gases; and
- machinery or apparatus containing liquid dangerous goods when it is required to ensure the liquid dangerous goods remain in their intended orientation (see special provision 301 of chapter 3.3),

shall be legibly marked with package orientation arrows which are similar to the illustration shown below or with those meeting the specifications of ISO 780:1997. The orientation arrows shall appear on two opposite vertical sides of the package with the arrows pointing in the correct upright direction. They shall be rectangular and of a size that is clearly visible commensurate with the size of the package. Depicting a rectangular border around the arrows is optional.

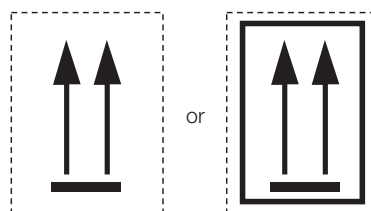

Two black or red arrows on white or suitable contrasting background.

The rectangular border is optional.

All features shall be in approximate proportion to those shown.

5.2.1.7.2 Orientation arrows are not required on:

- .1 outer packagings containing pressure receptacles except closed or open cryogenic receptacles;
- .2 outer packagings containing dangerous goods in inner packagings each containing not more than 120 mL, with sufficient absorbent material between the inner and outer packagings to completely absorb the liquid contents;
- .3 outer packagings containing Division 6.2 infectious substances in primary receptacles each containing not more than 50 mL;
- .4 type IP-2, type IP-3, type A, type B(U), type B(M) or type C packages containing class 7 radioactive material;
- .5 outer packagings containing articles which are leak-tight in all orientations (e.g. alcohol or mercury in thermometers, aerosols, etc.); or

.6 outer packagings containing dangerous goods in hermetically sealed inner packagings each containing not more than 500 mL.

5.2.1.7.3 Arrows for purposes other than indicating proper package orientation shall not be displayed on a package marked in accordance with this subsection.

5.2.1.8 **Excepted quantity mark**

5.2.1.8.1 Packages containing excepted quantities of dangerous goods shall be marked according to 3.5.4.

5.2.1.9 **Limited quantity mark**

5.2.1.9.1 Packages containing dangerous goods packed in limited quantities shall be marked according to 3.4.5.

△ 5.2.1.10 **Lithium or sodium ion battery mark**

△ 5.2.1.10.1 Packages containing lithium or sodium ion cells or batteries prepared in accordance with special provision 188 shall be marked as shown in figure below.

△ 5.2.1.10.2 The mark shall indicate the UN number, preceded by the letters “UN”, i.e. ‘UN 3090’ for lithium metal cells or batteries, ‘UN 3480’ for lithium ion cells or batteries, or ‘UN 3551’ for sodium ion cells or batteries. Where the cells or batteries are contained in, or packed with, equipment, the UN number preceded by the letters “UN”, i.e. ‘UN 3091’, ‘UN 3481’ or ‘UN 3552’ as appropriate shall be indicated. Where a package contains cells or batteries assigned to different UN numbers, all applicable UN numbers shall be indicated on one or more marks.

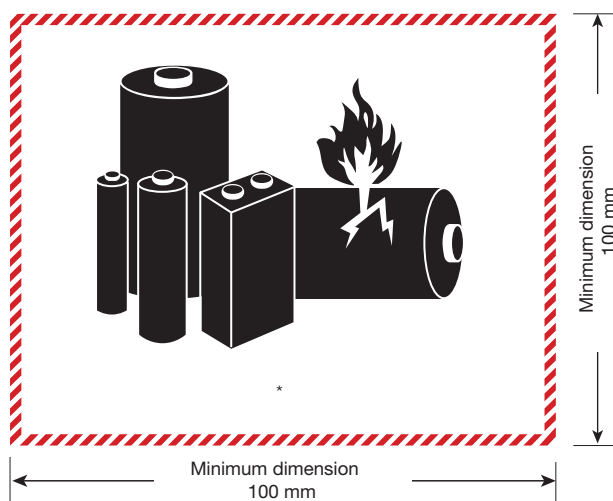

△ **Lithium or sodium ion battery mark**

\* Place for UN number(s)

△ The mark shall be in the form of a rectangle or a square with hatched edging. The dimensions shall be a minimum of 100 mm wide × 100 mm high and the minimum width of the hatching shall be 5 mm. The symbol (group of batteries, one damaged and emitting flame, above the UN number(s)) shall be black on white or suitable contrasting background. The hatching shall be red. If the size of the package so requires, the dimensions may be reduced to not less than 100 mm wide × 70 mm high. Where dimensions are not specified, all features shall be in approximate proportion to those shown.

**Note:** The mark shown in the figure “Lithium battery mark” in 5.2.1.10.2 of the IMDG Code Amendment 40-20, showing the telephone number for additional information, may continue to be applied until 31 December 2026.

5.2.2 **Labelling of packages including IBCs**

5.2.2.1 **Labelling provisions**

These provisions are related essentially to danger labels. However, additional marks or symbols indicating precautions to be taken in handling or storing a package (such as a symbol representing an umbrella, indicating that a package shall be kept dry) may be displayed on a package if appropriate.

Part 5 – Consignment procedures

5.2.2.1.1 Labels identifying primary and subsidiary hazards shall conform to models Nos. 1 to 9 illustrated in 5.2.2.2.2. The “EXPLOSIVE” subsidiary hazard label is model No. 1.

5.2.2.1.2 Where articles or substances are specifically listed in the Dangerous Goods List, a danger class label shall be affixed for the hazard shown in column 3. A subsidiary hazard label shall also be affixed for any hazard indicated by a class or division number in column 4 of the Dangerous Goods List. However, special provisions indicated in column 6 may also require a subsidiary hazard label where no subsidiary hazard is indicated in column 4 or may be exempt from the requirement for a subsidiary hazard label where such a hazard is indicated in the Dangerous Goods List.

5.2.2.1.2.1 A package containing a dangerous substance which has a low degree of danger may be exempt from these labelling requirements. In this case, a special provision specifying that no hazard label is required appears in column 6 of the Dangerous Goods List for the relevant substance. However, for certain substances the package shall be marked with the appropriate text as it appears in the special provision, for example:

| Substance  | UN No. | Class | Mark required on bales |
|--|--------|-------|------------------------|
| Baled hay in cargo transport unit                  | 1327   | 4.1   | None                   |
| Baled hay not in cargo transport unit              | 1327   | 4.1   | Class 4.1              |
| Baled dry vegetable fibres in cargo transport unit | 3360   | 4.1   | None                   |

| Substance  | UN No. | Class | Mark required on packages in addition to the proper shipping name and UN number |
|------------|--------|-------|---|
| Fish meal* | 1374   | 4.2   | Class 4.2 <sup>†</sup>  |

\* Only applicable to fish meal in packing group III.

<sup>†</sup> Exempt from class marking when loaded in a cargo transport unit containing only fish meal under UN 1374.

5.2.2.1.3 Except as provided in 5.2.2.1.3.1, if a substance which meets the definition of more than one class is not specifically listed by name in the Dangerous Goods List in chapter 3.2, the provisions in chapter 2.0 shall be used to determine the primary hazard class of the goods. In addition to the label required for that primary hazard class, subsidiary hazard labels shall also be applied as specified in the Dangerous Goods List.

5.2.2.1.3.1 Packagings containing substances of class 8 need not bear subsidiary hazard label model No. 6.1 if the toxicity arises solely from the destructive effect on tissue. Substances of class 4.2 need not bear subsidiary hazard label model No. 4.1.

5.2.2.1.4 **Labels for class 2 gases with subsidiary hazard(s)**

| Class | Subsidiary hazard(s) shown in chapter 2.2 | Primary hazard label | Subsidiary hazard label(s) |
|-------|---|----------------------|----------------------------|
| 2.1   | None                                      | 2.1                  | None                       |
| 2.2   | None                                      | 2.2                  | None                       |
|       | 5.1                                       | 2.2                  | 5.1                        |
| 2.3   | None                                      | 2.3                  | None                       |
|       | 2.1                                       | 2.3                  | 2.1                        |
|       | 5.1                                       | 2.3                  | 5.1                        |
|       | 5.1, 8                                    | 2.3                  | 5.1, 8                     |
|       | 8   | 2.3                  | 8                          |
|       | 2.1, 8                                    | 2.3                  | 2.1, 8                     |

5.2.2.1.5 Three separate labels have been provided for class 2, one for flammable gases of class 2.1 (red), one for non-flammable, non-toxic gases of class 2.2 (green) and one for toxic gases of class 2.3 (white). Where the Dangerous Goods List indicates that a class 2 gas possesses single or multiple subsidiary hazards, labels shall be used in accordance with the table in 5.2.2.1.4.

5.2.2.1.6 Except as provided in 5.2.2.2.1.2, each label shall:

- .1 be located on the same surface of the package near the proper shipping name mark, if the package dimensions are adequate;



- .2 be so placed on the packaging that it is not covered or obscured by any part or attachment to the packaging or any other label or mark; and
- .3 when primary and subsidiary hazard labels are required, be displayed next to each other.

Where a package is of such an irregular shape or small size that a label cannot be satisfactorily affixed, the label may be attached to the package by a securely affixed tag or other suitable means.

5.2.2.1.7 Intermediate bulk containers of more than 450 L capacity and large packagings shall be labelled on two opposing sides.

5.2.2.1.8 Labels shall be affixed on a surface of contrasting colour.

5.2.2.1.9 ***Special provisions for the labelling of self-reactive substances***

An “EXPLOSIVE” subsidiary hazard label (No. 1) shall be applied for type B self-reactive substances, unless the competent authority has permitted this label to be dispensed with for a specific packaging because test data have proved that the self-reactive substance in such a packaging does not exhibit explosive behaviour.

5.2.2.1.10 ***Special provisions for the labelling of organic peroxides***

The class 5.2 label (model No. 5.2) shall be affixed to packages containing organic peroxides classified as types B, C, D, E or F. This label also implies that the product may be flammable and hence no “FLAMMABLE LIQUID” subsidiary hazard label (model No. 3) is required. In addition, the following subsidiary hazard labels shall be applied:

- .1 An “EXPLOSIVE” subsidiary hazard label (model No. 1) for organic peroxides type B, unless the competent authority has permitted this label to be dispensed with for a specific packaging because test data have proved that the organic peroxide in such a packaging does not exhibit explosive behaviour.
- .2 A “CORROSIVE” subsidiary hazard label (model No. 8) is required when packing group I or II criteria of class 8 are met.

5.2.2.1.11 ***Special provisions for the labelling of infectious substances packages***

In addition to the primary hazard label (model No. 6.2), infectious substances packages shall bear any other label required by the nature of the contents.

5.2.2.1.12 ***Special provisions for the labelling of radioactive material***

5.2.2.1.12.1 Except when enlarged labels are used in accordance with 5.3.1.1.5.1, each package, overpack and freight container containing radioactive material shall bear the labels conforming to the applicable model Nos. 7A, 7B or 7C, according to the appropriate category. Labels shall be affixed to two opposite sides on the outside of the package or overpack or on the outside of all four sides of a freight container or tank. In addition, each package, overpack and freight container containing fissile material, other than fissile material excepted under the provisions of 2.7.2.3.5, shall bear labels conforming to model No. 7E; such labels, where applicable, shall be affixed adjacent to the labels conforming to the applicable model Nos. 7A, 7B or 7C. Labels shall not cover the marks specified in this chapter. Any labels which do not relate to the contents shall be removed or covered.

5.2.2.1.12.2 Each label conforming to the applicable model No. 7A, 7B or 7C shall be completed with the following information:

- .1 ***Contents:***
  - .1 Except for LSA-I material, the name(s) of the radionuclide(s) as taken from the table under 2.7.2.2.1, using the symbols prescribed therein. For mixtures of radionuclides, the most restrictive nuclides must be listed to the extent the space on the line permits. The group of LSA or SCO shall be shown following the name(s) of the radionuclide(s). The terms “LSA-II”, “LSA-III”, “SCO-I” and “SCO-II” shall be used for this purpose.
  - .2 For LSA-I material, the term “LSA-I” is all that is necessary; the name of the radionuclide is not necessary.
- .2 ***Activity:*** The maximum activity of the radioactive contents during transport, expressed in units of becquerels (Bq) with the appropriate SI prefix symbol (see 1.2.2.1). For fissile material, the total mass of fissile nuclides in units of grams (g), or multiples thereof, may be used in place of activity.
- .3 For overpacks and freight containers, the “contents” and “activity” entries on the label shall bear the information required in 5.2.2.1.12.2.1 and 5.2.2.1.12.2.2, respectively, totalled together for the entire contents of the overpack or freight container except that, on labels for overpacks or freight containers containing mixed loads of packages containing different radionuclides, such entries may read “See transport documents”.
- .4 ***Transport index:*** The number determined in accordance with 5.1.5.3.1 and 5.1.5.3.2 (except for category I-WHITE)

Part 5 – Consignment procedures

- 5.2.2.1.12.3 Each label conforming to the model No. 7E shall be completed with the criticality safety index (CSI) as stated in the certificate of approval applicable in the countries through or into which the consignment is transported and issued by the competent authority or as specified in 6.4.11.2 or 6.4.11.3.
- 5.2.2.1.12.4 For overpacks and freight containers, the label conforming to model No. 7E shall bear the sum of the criticality safety indexes of all the packages contained therein.
- 5.2.2.1.12.5 In all cases of international transport of packages requiring competent authority approval of design or shipment, for which different approval types apply in the different countries concerned by the shipment, labelling shall be in accordance with the certificate of the country of origin of design.
- 5.2.2.1.13 **Labels for articles containing dangerous goods transported as UN Nos. 3537, 3538, 3539, 3540, 3541, 3542, 3543, 3544, 3545, 3546, 3547 and 3548**
  - △ .1 Packages containing articles or articles transported unpackaged shall bear labels according to 5.2.2.1.2 reflecting the hazards established according to 2.0.6. If the article contains one or more lithium or sodium ion batteries with, for lithium metal batteries, an aggregate lithium content of 2 g or less, and for lithium ion or sodium ion batteries, a Watt-hour rating of 100 Wh or less, the lithium or sodium ion battery mark (5.2.1.10.2) shall be affixed to the package or unpackaged article. If the article contains one or more lithium or sodium ion batteries with, for lithium metal batteries, an aggregate lithium content of more than 2 g and for lithium ion or sodium ion batteries, a Watt-hour rating of more than 100 Wh, the battery label (5.2.2.2.2 No. 9A) shall be affixed to the package or unpackaged article.
  - .2 When it is required to ensure articles containing liquid dangerous goods remain in their intended orientation, orientation marks meeting 5.2.1.7.1 shall be affixed and visible on at least two opposite vertical sides of the package or of the unpackaged article where possible, with the arrows pointing in the correct upright direction.

5.2.2.2 Provisions for labels

- 5.2.2.2.1 Labels shall satisfy the provisions of this section and conform, in terms of colour, symbols, numbers and general format, to the specimen labels shown in 5.2.2.2.2.

**Note:** Where appropriate, labels in 5.2.2.2.2 are shown with a dotted outer boundary as provided for in 5.2.2.2.1.1. This is not required when the label is applied on a background of contrasting colour.

- 5.2.2.2.1.1 Labels shall be configured as shown in the figure below:

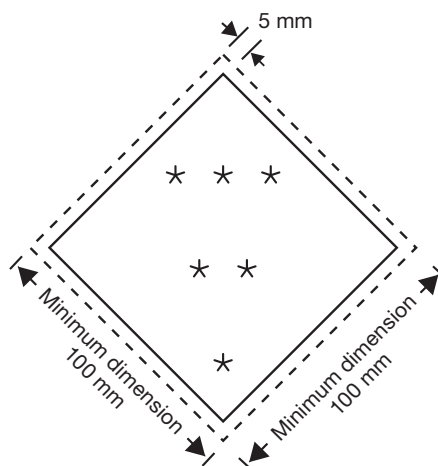

Class/division label

\* The class or, for divisions 5.1 and 5.2, the division number shall be shown in the bottom corner.

\*\* Additional text/numbers/symbol/letters shall (if mandatory) or may (if optional) be shown in this bottom half.

\*\*\* The class or division symbol or, for divisions 1.4, 1.5 and 1.6, the division number, and for model No. 7E, the word “FISSILE” shall be shown in this top half.

- 5.2.2.2.1.1.1 Labels shall be displayed on a background of contrasting colour, or shall have either a dotted or solid outer boundary line.
- 5.2.2.2.1.1.2 The label shall be in the form of a square set at an angle of 45 degrees (diamond-shaped). The minimum dimensions shall be 100 mm × 100 mm. There shall be a line inside the edge forming the diamond which shall be parallel and approximately 5 mm from the outside of that line to the edge of the label. Where dimensions are not specified, all features shall be in approximate proportion to those shown.





## Chapter 5.2 – Marking and labelling of packages including IBCs

- 5.2.2.2.1.3 If the size of the package so requires the dimensions may be reduced proportionally, provided the symbols and other elements of the label remain clearly visible. Dimensions for cylinders shall comply with 5.2.2.2.1.2.
- 5.2.2.2.1.2 Cylinders for class 2 may, on account of their shape, orientation and securing mechanisms for transport, bear labels representative of those specified in this section, which have been reduced in size, according to ISO 7225:2005, *Gas cylinders – Precautionary labels*, for display on the non-cylindrical part (shoulder) of such cylinders. Labels may overlap to the extent provided for by ISO 7225:2005; however, in all cases, the labels representing the primary hazard and the numbers appearing on any label shall remain fully visible and the symbols recognizable.
- Note:** When the diameter of the cylinder is too small to permit the display of the reduced size labels on the non-cylindrical upper part of the cylinder, the reduced sized labels may be displayed on the cylindrical part.
- 5.2.2.2.1.3 With the exception of labels for divisions 1.4, 1.5 and 1.6 of class 1, the upper half of the label shall contain the pictorial symbol and the lower half shall contain the class number 1, 2, 3, 4, 5.1, 5.2, 6, 7, 8 or 9 as appropriate. However, for label model No. 9A, the upper half of the label shall only contain the seven vertical stripes of the symbol and the lower half shall contain the group of batteries of the symbol and the class number. Except for label model No. 9A, the label may include such text as the UN number, or words describing the hazard class (e.g. “flammable”) in accordance with 5.2.2.2.1.5 provided that the text does not obscure or detract from the other required label elements.
- 5.2.2.2.1.4 In addition, except for divisions 1.4, 1.5 and 1.6, labels for class 1 shall show in the lower half, above the class number, the division number and compatibility group letter for the substance or article. Labels for divisions 1.4, 1.5 and 1.6 shall show in the upper half the division number and in the lower half the class number and the compatibility group letter. For division 1.4, compatibility group S, no label is generally required. However, in cases where a label is considered necessary for such goods, it shall be based on model No. 1.4.
- 5.2.2.2.1.5 On labels other than those for material of class 7, the insertion of any text (other than the class or division number) in the space below the symbol shall be confined to particulars indicating the nature of the hazard and precautions to be taken in handling. For label No. 9A, no text other than the class mark shall be included in the bottom part of the label.
- 5.2.2.2.1.6 The symbols, text and numbers shall be shown in black on all labels except for:
- .1 the class 8 label, where the text (if any) and class number shall appear in white;
  - .2 labels with entirely green, red or blue backgrounds, where they may be shown in white;
  - .3 the class 5.2 label, where the symbol may be shown in white; and
  - .4 class 2.1 labels displayed on cylinders and gas cartridges for liquefied petroleum gases, where they may be shown in the background colour of the receptacle if adequate contrast is provided.
- 5.2.2.2.1.7 The method of affixing the label(s) or applying stencil(s) of label(s) on packages containing dangerous goods shall be such that the label(s) or stencil(s) will still be identifiable on packages surviving at least three months’ immersion in the sea. In considering suitable labelling methods, account shall be taken of the durability of the packaging materials used and the surface of the package.
- 5.2.2.2.2 **Specimen labels**
- Note:** Labels shall satisfy the provisions below and conform, in terms of colour, symbols and general format, to the models shown in 5.2.2.2.2. Corresponding models required for other modes of transport, with minor variations which do not affect the obvious meaning of the label, are also acceptable.

Part 5 – Consignment procedures

5

Class 1: Explosives

| Label model no. | Class, Division or Category | Symbol and symbol colour  | Background | Figure in bottom corner (and figure colour) | Specimen labels  | Note   |
|-----------------|-----------------------------|---|------------|---|--|--|
| 1               | Divisions 1.1, 1.2, 1.3     | Explosion bomb: black   | Orange     | 1 (black)                                   |   | ** Place for division – to be left blank if explosive is the subsidiary hazard<br>* Place for compatibility group – to be left blank if explosive is the subsidiary hazard |
| 1.4             | Division 1.4                | 1.4: black<br>Numerals shall be about 30 mm in height and be about 5 mm thick (for a label measuring 100 mm x 100 mm) | Orange     | 1 (black)                                   |   | * Place for compatibility group  |
| 1.5             | Division 1.5                | 1.5: black<br>Numerals shall be about 30 mm in height and be about 5 mm thick (for a label measuring 100 mm x 100 mm) | Orange     | 1 (black)                                   |   | * Place for compatibility group  |
| 1.6             | Division 1.6                | 1.6: black<br>Numerals shall be about 30 mm in height and be about 5 mm thick (for a label measuring 100 mm x 100 mm) | Orange     | 1 (black)                                   |  | * Place for compatibility group  |

Class 2: Gases

| Label model no. | Class, Division or Category                  | Symbol and symbol colour   | Background | Figure in bottom corner (and figure colour)                        | Specimen labels | Note |
|-----------------|--|--|------------|--|-----------------|------|
| 2.1             | Class 2.1:<br>Flammable gases                | Flame: black or white<br>(except as provided for in 5.2.2.2.1.6.4) | Red        | 2<br>(black or white)<br>(except as provided for in 5.2.2.2.1.6.4) |                 | -    |
| 2.2             | Class 2.2:<br>Non-flammable, non-toxic gases | Gas cylinder: black or white                                       | Green      | 2<br>(black or white)  |                 | -    |
| 2.3             | Class 2.3:<br>Toxic gases                    | Skull and crossbones: black  | White      | 2<br>(black)   |                 | -    |

Class 3: Flammable liquids

| Label model no. | Class, Division or Category | Symbol and symbol colour | Background | Figure in bottom corner (and figure colour) | Specimen labels | Note |
|-----------------|-----------------------------|--------------------------|------------|---|-----------------|------|
| 3               | -                           | Flame: black or white    | Red        | 3<br>(black or white)                       |                 | -    |



Part 5 – Consignment procedures

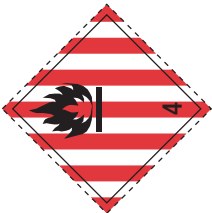
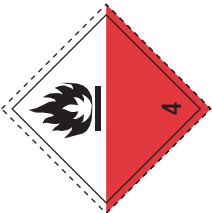
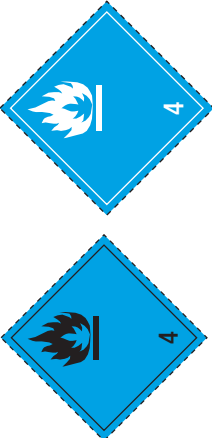

Class 4: Flammable solids; substances liable to spontaneous combustion; substances which, in contact with water, emit flammable gases

| Label model no. | Class, Division or Category   | Symbol and symbol colour | Background                        | Figure in bottom corner (and figure colour) | Specimen labels   | Note |
|-----------------|---|--------------------------|-----------------------------------|---|---|------|
| 4.1             | Class 4.1:<br>Flammable solids, self-reactive substances, polymerizing substances and solid desensitized explosives | Flame: black             | White with 7 vertical red stripes | 4 (black)                                   |  | -    |
| 4.2             | Class 4.2:<br>Substances liable to spontaneous combustion   | Flame: black             | Upper half white, lower half red  | 4 (black)                                   |  | -    |
| 4.3             | Class 4.3:<br>Substances which, in contact with water, emit flammable gases   | Flame: black or white    | Blue                              | 4 (black or white)                          |  | -    |

Class 5: Oxidizing substances and organic peroxides

| Label model no. | Class, Division or Category        | Symbol and symbol colour | Background                           | Figure in bottom corner (and figure colour) | Specimen labels   | Note |
|-----------------|------------------------------------|--------------------------|--------------------------------------|---|---|------|
| 5.1             | Class 5.1:<br>Oxidizing substances | Flame over circle: black | Yellow                               | 5.1<br>(black)                              |  | -    |
| 5.2             | Class 5.2:<br>Organic peroxides    | Flame: black or white    | Upper half red,<br>lower half yellow | 5.2<br>(black)                              |  | -    |

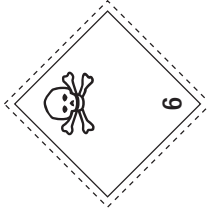
Class 6: Toxic and infectious substances

| Label model no. | Class, Division or Category         | Symbol and symbol colour                              | Background | Figure in bottom corner (and figure colour) | Specimen labels   | Note  |
|-----------------|-------------------------------------|---|------------|---|---|---|
| 6.1             | Class 6.1:<br>Toxic substances      | Skull and crossbones:<br>black                        | White      | 6<br>(black)                                |   | -   |
| 6.2             | Class 6.2:<br>Infectious substances | Three crescents<br>superimposed on a<br>circle: black | White      | 6<br>(black)                                |  | The lower half of the label may bear the inscriptions: "INFECTIOUS SUBSTANCE" and "In the case of damage or leakage immediately notify Public Health Authority" in black colour |

Part 5 – Consignment procedures



Class 7: Radioactive material

| Label model no. | Class, Division or Category | Symbol and symbol colour | Background  | Figure in bottom corner (and figure colour) | Specimen labels | Note   |
|-----------------|-----------------------------|--------------------------|---|---|-----------------|--|
| 7A              | Category I – WHITE          | Trefoil: black           | White   | 7 (black)                                   |                 | Text (mandatory), black in lower half of label: "RADIOACTIVE" "CONTENTS ..." "ACTIVITY ..." One red vertical bar shall follow the word: "RADIOACTIVE"  |
| 7B              | Category II – YELLOW        | Trefoil: black           | Upper half yellow with white border, lower half white | 7 (black)                                   |                 | Text (mandatory), black in lower half of label: "RADIOACTIVE" "CONTENTS ..." "ACTIVITY ..." In a black outlined box: "TRANSPORT INDEX"; Two red vertical bars shall follow the word: "RADIOACTIVE"   |
| 7C              | Category III – YELLOW       | Trefoil: black           | Upper half yellow with white border, lower half white | 7 (black)                                   |                 | Text (mandatory), black in lower half of label: "RADIOACTIVE" "CONTENTS ..." "ACTIVITY ..." In a black outlined box: "TRANSPORT INDEX"; Three red vertical bars shall follow the word: "RADIOACTIVE" |
| 7E              | Fissile material            | –                        | White   | 7 (black)                                   |                 | Text (mandatory): black in upper half of label: "FISSILE"; In a black outlined box in the lower half of label: "CRITICALITY SAFETY INDEX"  |

Class 8: Corrosive substances

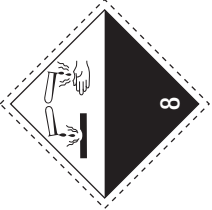
| Label model no. | Class, Division or Category | Symbol and symbol colour   | Background   | Figure in bottom corner (and figure colour) | Specimen labels   | Note |
|-----------------|-----------------------------|--|--|---|---|------|
| 8               | –                           | Liquids, spilling from two glass vessels and attacking a hand and a metal: black | Upper half white, lower half black with white border | 8 (white)                                   |  | –    |

Class 9: Miscellaneous dangerous substances and articles, including environmentally hazardous substances

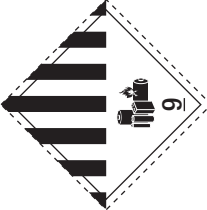
| Label model no. | Class, Division or Category | Symbol and symbol colour   | Background | Figure in bottom corner (and figure colour) | Specimen labels   | Note |
|-----------------|-----------------------------|--|------------|---|---|------|
| 9               | –                           | 7 vertical stripes in upper half: black  | White      | 9 underlined (black)                        |    | –    |
| 9A              | –                           | 7 vertical stripes in upper half: black; battery group, one broken and emitting flame in lower half: black | White      | 9 underlined (black)                        |  | –    |

## Chapter 5.3

### *Placarding and marking of cargo transport units and bulk containers*

#### 5.3.1 Placarding

##### 5.3.1.1 Placarding provisions

##### 5.3.1.1.1 *General provisions*

- .1 Enlarged labels (placards) and marks and signs shall be affixed to the exterior surfaces of a cargo transport unit or bulk container to provide a warning that the contents of the unit or bulk container are dangerous goods and present hazards, unless the labels and/or marks affixed to the packages are clearly visible from the exterior of the cargo transport unit or bulk container.
- .2 The methods of placarding and marking as required in 5.3.1.1.4 and 5.3.2 on cargo transport units and bulk containers shall be such that this information will still be identifiable on cargo transport units and bulk containers surviving at least three months' immersion in the sea. In considering suitable marking methods, account shall be taken of the ease with which the surface of the cargo transport unit or bulk container can be marked.
- .3 All placards, orange panels, marks and signs shall be removed from cargo transport units and bulk containers or masked as soon as both the dangerous goods or their residues which led to the application of those placards, orange panels, marks or signs are discharged.

5.3.1.1.2 Placards shall be affixed to the exterior surface of cargo transport units and bulk containers to provide a warning that the contents of the unit are dangerous goods and present hazards. Placards shall correspond to the primary hazard of the goods contained in the cargo transport unit and bulk container except that:

- .1 placards are not required on cargo transport units carrying any quantity of explosives of division 1.4, compatibility group S; and
- .2 placards indicating the highest hazard only need be affixed on cargo transport units carrying substances and articles of more than one division in class 1.

Placards shall be displayed on a background of contrasting colour, or shall have either a dotted or solid outer boundary line.

For dangerous goods of class 9 the placard shall correspond to the label model No. 9 as in 5.2.2.2.2; label model No. 9A shall not be used for placarding purposes.

5.3.1.1.3 Placards shall also be displayed for those subsidiary hazards for which a subsidiary hazard label is required according to 5.2.2.1.2. However, cargo transport units and bulk containers containing goods of more than one class need not bear a subsidiary hazard placard if the hazard represented by that placard is already indicated by a primary hazard placard.

##### 5.3.1.1.4 *Placarding requirements*

5.3.1.1.4.1 A cargo transport unit or bulk container containing dangerous goods or residues of dangerous goods shall clearly display placards as follows:

- .1 *a freight container, semi-trailer, a closed or sheeted bulk container or portable tank*: one on each side and one on each end of the unit. Portable tanks having a capacity of not more than 3,000 L may be placarded or, alternatively, may be labelled instead, on only two opposite sides;
- .2 *a railway wagon*: at least on each side;
- .3 *a multiple-compartment tank containing more than one dangerous substance or their residues*: along each side at the positions of the relevant compartments. If all compartments are required to display the same placards, these placards need to be displayed only once along each side of the cargo transport unit;
- .4 *a flexible bulk container*: in at least two opposing positions; and
- .5 *any other cargo transport unit*: at least on both sides and on the back of the unit.

## Chapter 5.3 – Placarding and marking of cargo transport units and bulk containers

5.3.1.1.5 *Special provisions for class 7*

5.3.1.1.5.1 Large freight containers carrying unpackaged LSA-I material or SCO-I or SCO-III or packages other than excepted packages, and tanks, shall bear four placards which conform with the model No. 7D given in the figure. The placards shall be affixed in a vertical orientation to each side wall and each end wall of the large freight container or tank. Any placards which do not relate to the contents shall be removed. Instead of using both labels and placards, it is permitted as an alternative to use enlarged labels only, as shown in label model Nos. 7A, 7B and 7C, except having the minimum size shown in the figure under 5.3.1.2.2.

5.3.1.1.5.2 Rail and road vehicles carrying packages, overpacks or freight containers labelled with any of the labels shown in 5.2.2.2.2 as model Nos. 7A, 7B, 7C and 7E, or carrying consignments under exclusive use, shall display the placard shown in the figure (model No. 7D) on each of:

- .1 the two external lateral walls, in the case of a rail vehicle;
- .2 the two external lateral walls and the external rear wall, in the case of a road vehicle.

In the case of a vehicle without sides, the placards may be affixed directly on the cargo-carrying unit provided that they are readily visible; in the case of physically large tanks or freight containers, the placards on the tanks or freight containers shall suffice. In the case of vehicles which have insufficient area to allow the fixing of larger placards, the dimensions of the placard as described in the figure may be reduced to 100 mm. Any placards which do not relate to the contents shall be removed.

5.3.1.2 **Specifications for placards**

5.3.1.2.1 Except as provided in 5.3.1.2.2 for the class 7 placard, and in 5.3.2.3.2 for the marine pollutant mark, a placard shall be configured as shown in the figure below.

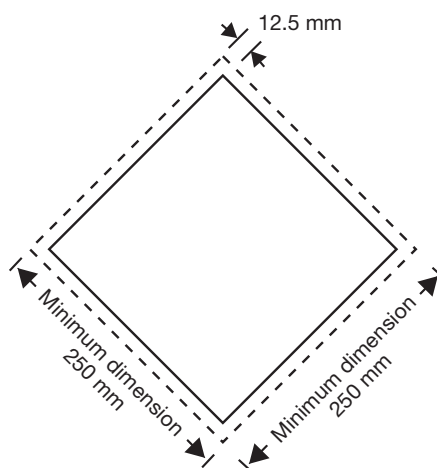

Placard (except for class 7)

The placard shall be in the form of a square set at an angle of 45° (diamond-shaped). The minimum dimensions shall be 250 mm × 250 mm (to the edge of the placard). The line inside the edge shall be parallel and 12.5 mm from the outside of that line to the edge of the placard. The symbol and line inside the edge shall correspond in colour to the label for the class or division of the dangerous goods in question. The class or division symbol/ numeral shall be positioned and sized in proportion to those prescribed in 5.2.2.2 for the corresponding class or division of the dangerous goods in question. The placard shall display the number of the class or division (and for goods in class 1, the compatibility group letter) of the dangerous goods in question in the manner prescribed in 5.2.2.2 for the corresponding label, in digits not less than 25 mm high. Where dimensions are not specified, all features shall be in approximate proportion to those shown.

5.3.1.2.2 For class 7, the placard shall have minimum overall dimensions of 250 mm by 250 mm (except as permitted by 5.3.1.1.5.2) with a black line running 5 mm inside the edge and parallel with it, and shall be otherwise as shown in the figure below. When different dimensions are used, the relative proportions shall be maintained. The number “7” shall not be less than 25 mm high. The background colour of the upper half of the placard shall be yellow and of the lower half white; the colour of the trefoil and the printing shall be black. The use of the word “RADIOACTIVE” in the bottom half is optional to allow the use of this placard to display the appropriate United Nations Number for the consignment.

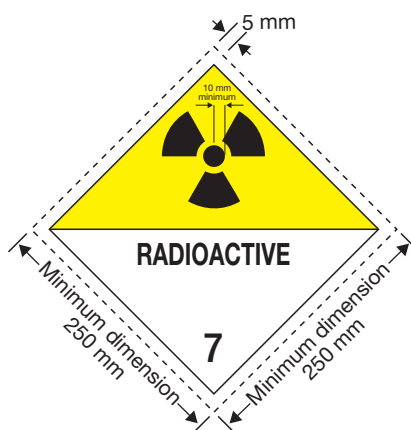

Placard for radioactive material of class 7

(No. 7D)

Symbol (trefoil): black.

Background: upper half yellow with white border, lower half white.

The lower half shall show the word **RADIOACTIVE** or alternatively, when required (see 5.3.2.1), the appropriate UN number and the figure '7' in the bottom corner.

## 5.3.2 Marking

### 5.3.2.0 Display of proper shipping name

5.3.2.0.1 The proper shipping name of the contents shall be durably marked on at least both sides of:

- .1 tank cargo transport units containing dangerous goods;
- .2 bulk containers containing dangerous goods; or
- .3 any other cargo transport unit containing packaged dangerous goods of a single commodity for which no placard, UN number or marine pollutant mark is required. Alternatively, the UN number may be displayed.

5.3.2.0.2 The proper shipping name for the goods shall be displayed in characters not less than 65 mm high. The proper shipping name shall be of contrasting colour with the background. This may be reduced to 12 mm for portable tank containers with a capacity of not more than 3,000 L.

### 5.3.2.1 Display of UN numbers

5.3.2.1.1 Except for goods of class 1, the UN number shall be displayed as required by this chapter on consignments of:

- .1 solids, liquids or gases transported in tank cargo transport units, including on each compartment of a multi-compartment tank cargo transport unit;
- .2 packaged dangerous goods loaded in excess of 4000 kg gross mass, to which only one UN number has been assigned and which are the only dangerous goods in the cargo transport unit;
- .3 unpackaged LSA-I material, SCO-I or SCO-III material of class 7 in or on a vehicle, or in a freight container, or in a tank;
- .4 packaged radioactive material with a single UN number in or on a vehicle, or in a freight container, when required to be transported under exclusive use;
- .5 solid dangerous goods in bulk containers.

5.3.2.1.2 The UN number for the goods shall be displayed in black digits not less than 65 mm high, either:

- .1 against a white background in the area below the pictorial symbol and above the class number and the compatibility group letter in a manner that does not obscure or detract from the other required placard elements (see 5.3.2.1.3); or
- .2 on an orange rectangular panel not less than 120 mm high and 300 mm wide, with a 10 mm black border, to be placed immediately adjacent to each placard or marine pollutant mark (see 5.3.2.1.3). For portable tanks with a capacity of not more than 3,000 L, the UN number may be displayed on an orange rectangular panel of appropriately reduced size on the external surface of the tank in characters not less than 25 mm high. When no placard or marine pollutant mark is required, the UN number shall be displayed immediately adjacent to the proper shipping name.

5.3.2.1.3 *Examples of display of UN numbers*

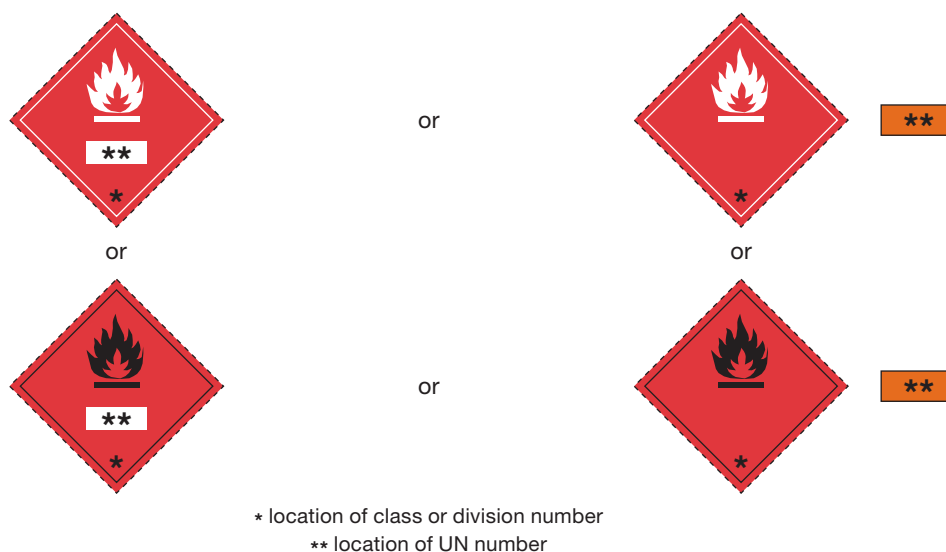

5.3.2.2 **Elevated temperature substance mark**

5.3.2.2.1 Cargo transport units containing a substance that is transported or offered for transport in a liquid state at a temperature equal to or exceeding 100°C or in a solid state at a temperature equal to or exceeding 240°C shall bear on each side and on each end the mark shown in the figure below.

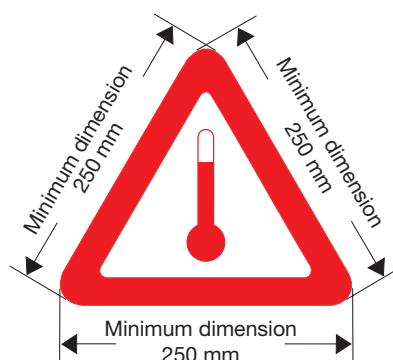

Mark for transport at elevated temperature

The mark shall be an equilateral triangle. The colour of the mark shall be red. The minimum dimension of the sides shall be 250 mm except for portable tanks with a capacity of not more than 3,000 L where the sides may be reduced to 100 mm. Where dimensions are not specified, all features shall be in approximate proportion to those shown.

5.3.2.2.2 In addition to the elevated temperature mark, the maximum temperature of the substance expected to be reached during transport shall be durably marked on both sides of the portable tank or insulation jacket, immediately adjacent to the elevated temperature mark, in characters at least 100 mm high.

5.3.2.3 **Marine pollutant mark**

5.3.2.3.1 Except as provided in 2.10.2.7, cargo transport units or bulk containers containing marine pollutants shall clearly display the marine pollutant mark in locations indicated in 5.3.1.1.4.1.

5.3.2.3.2 The marine pollutant mark for cargo transport units and bulk containers shall be as described in 5.2.1.6.3, except that the minimum dimensions shall be 250 mm × 250 mm. For portable tanks with a capacity of not more than 3,000 L, the dimensions may be reduced to 100 mm × 100 mm.

5.3.2.4 **Limited quantities**

Cargo transport units containing dangerous goods packed in limited quantities shall be placarded and marked according to 3.4.5.5.



## Chapter 5.4

### Documentation

- Note 1** The provisions of this Code do not preclude the use of electronic data processing (EDP) and electronic data interchange (EDI) transmission techniques as an alternative to paper documentation. All references to “dangerous goods transport document” in this chapter also include provision of the required information by use of EDP and EDI transmission techniques.
- Note 2** When dangerous goods are offered for transport, similar documents to those required for other categories of goods have to be prepared. The form of these documents, the particulars to be entered on them and the obligations they entail may be fixed by international conventions applying to certain modes of transport and by national legislation.
- Note 3** One of the primary requirements of a transport document for dangerous goods is to convey the fundamental information relative to the hazards of the goods. It is, therefore, necessary to include certain basic information on the document for a consignment of dangerous goods unless otherwise exempted or required in this Code.
- Note 4** In addition to the provisions of this chapter, other elements of information may be required by the competent authority.
- Note 5** In addition to the provisions of this chapter other additional information may be included. However, this information shall not:
- .1 divert attention from the safety information required by this chapter or by the competent authority;
  - .2 contradict the safety information required by this chapter or by the competent authority; or
  - .3 duplicate information already provided.

#### 5.4.1 Dangerous goods transport information

##### 5.4.1.1 General

5.4.1.1.1 Except as otherwise provided, the consignor who offers dangerous goods for transport shall give to the carrier the information applicable to those dangerous goods, including any additional information and documentation as specified in this Code. This information may be provided on a dangerous goods transport document or, with the agreement of the carrier, by EDP or EDI techniques.

5.4.1.1.2 When the dangerous goods transport information is given to the carrier by EDP or EDI techniques, the consignor shall be able to produce the information without delay as a paper document, with the information in the sequence required by this chapter.

##### 5.4.1.2 Form of the transport document

5.4.1.2.1 A dangerous goods transport document may be in any form, provided it contains all of the information required by the provisions of this Code.

5.4.1.2.2 If both dangerous and non-dangerous goods are listed in one document, the dangerous goods shall be listed first, or otherwise be emphasized.

##### 5.4.1.2.3 Continuation page

A dangerous goods transport document may consist of more than one page, provided pages are consecutively numbered.

5.4.1.2.4 The information on a dangerous goods transport document shall be easy to identify, legible and durable.

#### 5.4.1.2.5 *Example of a dangerous goods transport document*

The form shown in the figure in 5.4.5 is an example of a dangerous goods transport document.\*

#### 5.4.1.3 **Consignor, consignee and date**

The name and address of the consignor and the consignee of the dangerous goods shall be included on the dangerous goods transport document. The date the dangerous goods transport document or an electronic copy of it was prepared or given to the initial carrier shall be included.

#### 5.4.1.4 **Information required on the dangerous goods transport document**

##### 5.4.1.4.1 *Dangerous goods description*

The dangerous goods transport document shall contain the following information for each dangerous substance, material or article offered for transport:

- .1 the UN number preceded by the letters “UN”;
- .2 the proper shipping name, as determined according to 3.1.2, including the technical name enclosed in parenthesis, as applicable (see 3.1.2.8);
- .3 the primary hazard class or, when assigned, the division of the goods, including, for class 1, the compatibility group letter. The words “Class” or “Division” may be included preceding the primary hazard class or division numbers;
- .4 subsidiary hazard class or division number(s) corresponding to the subsidiary hazard label(s) required to be applied, when assigned, shall be entered following the primary hazard class or division and shall be enclosed in parenthesis. The words “Class” or “Division” may be included preceding the subsidiary hazard class or division numbers;
- .5 where assigned, the packing group for the substance or article, which may be preceded by “PG” (e.g. “PG II”).

##### 5.4.1.4.2 *Sequence of the dangerous goods description*

The five elements of the dangerous goods description specified in 5.4.1.4.1 shall be shown in the order listed above (i.e. .1, .2, .3, .4, and .5) with no information interspersed, except as provided in this Code. Unless permitted or required by this Code, additional information shall be placed after the dangerous goods description.

##### 5.4.1.4.3 *Information which supplements the proper shipping name in the dangerous goods description*

The proper shipping name (see 3.1.2) in the dangerous goods description shall be supplemented as follows:

- .1 *Technical names for “n.o.s.” and other generic descriptions:* proper shipping names that are assigned special provision 274 or 318 in column 6 of the Dangerous Goods List shall be supplemented with their technical or chemical group names as described in 3.1.2.8.
- .2 *Empty uncleaned packagings, bulk containers and tanks:* Empty means of containment (including packagings, IBCs, bulk containers, portable tanks, road tank vehicles and railway tank wagons) which contain the residue of dangerous goods of classes other than class 7 shall be described as such by, for example, placing the words “EMPTY UNCLEANED” or “RESIDUE LAST CONTAINED” before or after the dangerous goods description specified in 5.4.1.4.1.1 to .5.
- .3 *Wastes:* For waste dangerous goods (other than radioactive wastes) which are being transported for disposal, or for processing for disposal, the proper shipping name shall be preceded by the word “WASTE”, unless this is already a part of the proper shipping name.
- .4 *Molten substances:* When a substance which is solid in accordance with the definition in 1.2.1 is offered for transport in the molten state, the qualifying word “MOLTEN” shall be added as part of the proper shipping name, unless it is already part of the proper shipping name (see 3.1.2.5).
- .5 *Elevated temperature substances:* If the proper shipping name of a substance which is transported or offered for transport in a liquid state at a temperature equal to or exceeding 100°C, or in a solid state at a temperature equal to or exceeding 240°C, does not convey the elevated temperature condition (for

\* For standardized formats, see also the relevant recommendations of the UNECE United Nations Centre for Trade Facilitation and Electronic Business (UN/CEFACT), in particular Recommendation No. 1 (United Nations Layout Key for Trade Documents) (ECE/TRADE/137, edition 81.3), UN Layout Key for Trade Documents – Guidelines for Applications (ECE/TRADE/270, edition 2002), Revised recommendation No. 11 (Documentary Aspects of the International Transport of Dangerous Goods) (ECE/TRADE/C/CEFACT/2008/8) and Recommendation No. 22 (Layout Key for Standard Consignment Instructions) (ECE/TRADE/168, edition 1989). Refer also to the UN/CEFACT Summary of Trade Facilitation Recommendations (ECE/TRADE/346, edition 2006) and the United Nations Trade Data Elements Directory (UNTDDED) (ECE/TRADE/362, edition 2005).

**Part 5 – Consignment procedures**

example, by using the term “MOLTEN” or “ELEVATED TEMPERATURE” as part of the proper shipping name), the word “HOT” shall immediately precede the proper shipping name.

- .6 *Marine pollutants:* Except as provided in 2.10.2.7, if the goods to be transported are marine pollutants, the goods shall be identified as “MARINE POLLUTANT”, and for “not otherwise specified” (N.O.S.) entries the proper shipping name shall be supplemented with the recognized chemical name of the marine pollutant (see 3.1.2.9). The term “MARINE POLLUTANT” may be supplemented with the term “ENVIRONMENTALLY HAZARDOUS”.
- .7 *Flashpoint:* If the liquid dangerous goods to be transported have a primary or subsidiary hazard of class 3 and a flashpoint of 60°C or below (in °C closed-cup (c.c.)), the minimum flashpoint shall be indicated. Because of the presence of impurities, the flashpoint may be lower or higher than the reference temperature indicated in the Dangerous Goods List for the substance.
- .8 *Damaged/defective lithium cells or batteries and lithium cells or batteries for disposal or recycling:* When lithium cells or batteries are offered for transport under special provision 376 or special provision 377, “DAMAGED/DEFECTIVE”, “LITHIUM BATTERIES FOR DISPOSAL” or “LITHIUM BATTERIES FOR RECYCLING” shall be indicated, as appropriate.
- .9 *Stabilized and temperature controlled substances:* Unless already part of the proper shipping name, the word “STABILIZED” shall be added to the proper shipping name if stabilization is used and the words “TEMPERATURE CONTROLLED” shall be added to the proper shipping name if stabilization is by temperature control or a combination of chemical stabilization and temperature control (see 3.1.2.6).

**5.4.1.4.4 Examples of dangerous goods descriptions:**

UN 1092, Acrolein, stabilized, class 6.1 (3), PG I, (–24°C c.c.), MARINE POLLUTANT/ENVIRONMENTALLY HAZARDOUS

UN 1603, ETHYL BROMOACETATE 6.1 (3) II (58°C c.c.)

UN 1603, ETHYL BROMOACETATE, class 6.1, (class 3), PG II, (58°C c.c.)

UN 2761, Organochlorine pesticide, solid, toxic, (Aldrin 19%), class 6.1, PG III, MARINE POLLUTANT

**5.4.1.5 Information required in addition to the dangerous goods description**

In addition to the dangerous goods description, the following information shall be included after the dangerous goods description on the dangerous goods transport document.

**5.4.1.5.1 Total quantity of dangerous goods**

Except for empty uncleaned packagings, the total quantity of dangerous goods covered by the description (by volume or mass as appropriate) of each item of dangerous goods bearing a different proper shipping name, UN number or packing group shall be included. For class 1 dangerous goods, the quantity shall be the net explosive mass. For dangerous goods transported in salvage packagings, an estimate of the quantity of dangerous goods shall be given. The number and kind (e.g. drum, box, etc.) of packages shall also be indicated. UN packaging codes may only be used to supplement the description of the kind of package (e.g. one box (4G)). Abbreviations may be used to specify the unit of measurement for the total quantity.

**Note:** The number, type and capacity of each inner packaging within the outer packaging of a combination packaging is not required to be indicated.

**5.4.1.5.2 Limited quantities**

**5.4.1.5.2.1** When dangerous goods are transported according to the exceptions for dangerous goods packed in limited quantities provided for in column 7a of the Dangerous Goods List and chapter 3.4, the words “limited quantity” or “LTD QTY” shall be included.

**5.4.1.5.2.2** Where a shipment is offered in accordance with 3.4.4.1.2, the following statement shall be included in the transport document: “Transport in accordance with 3.4.4.1.2 of the IMDG Code”.

**5.4.1.5.3 Salvage packagings including large salvage packagings and salvage pressure receptacles**

For dangerous goods transported in salvage packagings in accordance with 4.1.1.18, including large salvage packagings, larger size packagings or large packagings of appropriate type and performance level to be used as a salvage packaging, the words “SALVAGE PACKAGING” shall be included.

For dangerous goods transported in salvage pressure receptacles in accordance with 4.1.1.19, the words “SALVAGE PRESSURE RECEPTACLE” shall be included.

**5.4.1.5.4 Substances stabilized by temperature control**

If the words “TEMPERATURE CONTROLLED” are part of the proper shipping name (see also 3.1.2.6), the control and emergency temperatures (see 7.3.7.2) shall be indicated in the transport document, as follows:

“Control temperature: ... °C                      Emergency temperature: ... °C”.

**5.4.1.5.5 Self-reactive substances, polymerizing substances and organic peroxides**

For self-reactive substances, organic peroxides and polymerizing substances which require temperature control during transport, the control and emergency temperatures (see 7.3.7.2) shall be indicated on the dangerous goods transport document, as follows:

“Control temperature: ... °C                      Emergency temperature: ... °C”.

**5.4.1.5.5.1** When, for certain self-reactive substances and polymerizing substances of class 4.1 and organic peroxides of class 5.2, the competent authority has permitted the “EXPLOSIVE” subsidiary hazard label (model No. 1) to be dispensed with for the specific package, a statement to this effect shall be included.

**5.4.1.5.5.2** When organic peroxides and self-reactive substances are transported under conditions where approval is required (for organic peroxides, see 2.5.3.2.5, 4.1.7.2.2, 4.2.1.13.1 and 4.2.1.13.3; for self-reactive substances, see 2.4.2.3.2.4 and 4.1.7.2.2), a statement to this effect shall be included in the dangerous goods transport document. A copy of the classification approval and conditions of transport for non-listed organic peroxides and self-reactive substances shall be attached to the dangerous goods transport document.

**5.4.1.5.5.3** When a sample of an organic peroxide (see 2.5.3.2.5.1) or a self-reactive substance (see 2.4.2.3.2.4.2) is transported, a statement to this effect shall be included in the dangerous goods transport document.

**5.4.1.5.6 Infectious substances**

The full address of the consignee shall be shown on the document, together with the name of a responsible person and their telephone number.

**5.4.1.5.7 Radioactive material**

**5.4.1.5.7.1** The following information shall be included for each consignment of class 7 material, as applicable, in the order given:

- .1 the name or symbol of each radionuclide or, for mixtures of radionuclides, an appropriate general description or a list of the most restrictive nuclides;
- .2 a description of the physical and chemical form of the material, or a notation that the material is special form radioactive material or low dispersible radioactive material. A generic chemical description is acceptable for chemical form;
- .3 the maximum activity of the radioactive contents during transport expressed in units of becquerels (Bq) with an appropriate SI prefix symbol (see 1.2.2.1). For fissile material, the mass of fissile material (or mass of each fissile nuclide for mixtures when appropriate) in units of grams (g), or appropriate multiples thereof, may be used in place of activity;
- .4 the category of the package, overpack or freight container, as assigned per paragraph 5.1.5.3.4, i.e. I-WHITE, II-YELLOW, III-YELLOW;
- .5 the TI as determined per paragraphs 5.1.5.3.1 and 5.1.5.3.2 (except for category I-WHITE);
- .6 for fissile material:
  - .1 shipped under one exception of 2.7.2.3.5.1 to 2.7.2.3.5.6, reference to that paragraph;
  - .2 shipped under 2.7.2.3.5.3 to 2.7.2.3.5.5, the total mass of fissile nuclides;
  - .3 contained in a package for which one of 6.4.11.2 (a) to (c) or 6.4.11.3 is applied, reference to that paragraph;
  - .4 the criticality safety index, where applicable.
- .7 the identification mark for each competent authority certificate of approval (special form radioactive material, low dispersible radioactive material, fissile material excepted under 2.7.2.3.5.6, special arrangement, package design, or shipment) applicable to the consignment;
- .8 for consignments of more than one package, the information contained in 5.4.1.4.1.1 to .3 and 5.4.1.5.7.1.1 to .7 shall be given for each package. For packages in an overpack, freight container, or conveyance, a detailed statement of the contents of each package within the overpack, freight container, or conveyance and, where appropriate, of each overpack, freight container, or conveyance shall be included. If packages are to be removed from the overpack, freight container, or conveyance at a point of intermediate unloading, appropriate transport documents shall be made available;
- .9 where a consignment is required to be shipped under exclusive use, the statement “EXCLUSIVE USE SHIPMENT”; and

**Part 5 – Consignment procedures**

.10 for LSA-II, LSA-III, SCO-I, SCO-II and SCO-III, the total activity of the consignment as a multiple of  $A_2$ . For radioactive material for which the  $A_2$  value is unlimited, the multiple of  $A_2$  shall be zero.

**5.4.1.5.7.2** The transport document shall include a statement regarding actions, if any, that are required to be taken by the carrier. The statement shall be in the languages deemed necessary by the carrier or the authorities concerned, and shall include at least the following points:

- .1 supplementary requirements for loading, stowage, transport, handling and unloading of the package, overpack or freight container, including any special stowage provisions for the safe dissipation of heat (see 7.1.4.5.2), or a statement that no such requirements are necessary;
- .2 restrictions on the mode of transport or conveyance and any necessary routing instructions;
- .3 emergency arrangements appropriate to the consignment.

**5.4.1.5.7.3** In all cases of international transport of packages requiring competent authority approval of design or shipment, for which different approval types apply in the different countries concerned by the shipment, the UN number and proper shipping name required in 5.4.1.4.1 shall be in accordance with the certificate of the country of origin of design.

**5.4.1.5.7.4** The applicable competent authority certificates need not necessarily accompany the consignment. The consignor shall make them available to the carrier(s) before loading and unloading.

**5.4.1.5.8** **Aerosols**

If the capacity of an aerosol is above 1000 mL, this shall be declared in the transport document.

**5.4.1.5.9** **Explosives**

The following information shall be included for each consignment of class 1 goods, as applicable:

- .1 Entries have been included for “SUBSTANCES, EXPLOSIVE, N.O.S.”, “ARTICLES, EXPLOSIVE, N.O.S.”, and “COMPONENTS, EXPLOSIVE TRAIN, N.O.S.”. When a specific entry does not exist, the competent authority of the country of origin shall use the entry appropriate to the hazard division and compatibility group. The transport document shall contain the statement: “Transport under this entry approved by the competent authority of ...” followed by the State’s distinguishing sign used on vehicles in international road traffic\* of the country of the competent authority.
- .2 The transport of explosive substances for which a minimum water or phlegmatizer content is specified in the individual entry is prohibited when containing less water or phlegmatizer than the specified minimum. Such substances shall only be transported with special authorization granted by the competent authority of the country of origin. The transport document shall contain the statement “Transport under this entry approved by the competent authority of ...” followed by the State’s distinguishing sign used on vehicles in international road traffic\* of the country of the competent authority.
- .3 When explosive substances or articles are packaged “as approved by the competent authority”, the transport document shall contain the statement “Packaging approved by the competent authority of ...” followed by the State’s distinguishing sign used on vehicles in international road traffic\* of the country of the competent authority.
- .4 There are some hazards which are not indicated by the hazard division and compatibility group of a substance. The shipper shall provide an indication of any such hazards on the dangerous goods documentation.

**5.4.1.5.10** **Viscous substances**

When viscous substances are transported in accordance with 2.3.2.5, the following statement shall be included in the transport document: “Transport in accordance with 2.3.2.5 of the IMDG Code.”.

**5.4.1.5.11** **Special provisions for segregation**

**5.4.1.5.11.1** For substances, mixtures, solutions or preparations classified under N.O.S. entries not included in the segregation groups listed in 3.1.4.4 but belonging, in the opinion of the consignor, to one of these groups (see 3.1.4.2), the appropriate segregation group name or segregation group code (SGG) listed in 7.2.5.2 preceded by the phrase “IMDG Code segregation group” shall be included in the transport document after the dangerous goods description. For example:

- “UN 1760 CORROSIVE LIQUID, N.O.S. (phosphoric acid, acetic acid) 8 III IMDG Code segregation group 1 – Acids”; or  
 “UN 1760 CORROSIVE LIQUID, N.O.S. (phosphoric acid, acetic acid) 8 III IMDG Code segregation group SGG1.

\* Distinguishing sign of the State of registration used on motor vehicles and trailers in international road traffic, e.g. in accordance with the Geneva Convention on Road Traffic of 1949 or the Vienna Convention on Road Traffic of 1968.

5.4.1.5.11.2 When substances are loaded together in a cargo transport unit in accordance with 7.2.6.3, the following statement shall be included in the transport document: “Transport in accordance with 7.2.6.3 of the IMDG Code”.

5.4.1.5.11.3 When acid and alkali substances of class 8 are transported in the same cargo transport unit, whether in the same packaging or not, in accordance with 7.2.6.5, the following statement shall be included in the transport document: “Transport in accordance with 7.2.6.5 of the IMDG Code”.

#### 5.4.1.5.12 *Transport of solid dangerous goods in bulk containers*

For bulk containers other than freight containers, the following statement shall be included on the transport document (see 6.9.4.6):

“Bulk container BK(x) approved by the competent authority of ...”

**Note:** “(x)” shall be replaced with “1” or “2”, as appropriate.

#### 5.4.1.5.13 *Transport of IBCs or portable tanks after the date of expiry of the last periodic test or inspection*

For transport in accordance with 4.1.2.2.2, 6.7.2.19.6.2, 6.7.3.15.6.2 or 6.7.4.14.6.2, a statement to this effect shall be included in the transport document, as follows: “Transport in accordance with 4.1.2.2.2”, “Transport in accordance with 6.7.2.19.6.2”, “Transport in accordance with 6.7.3.15.6.2” or “Transport in accordance with 6.7.4.14.6.2” as appropriate.

#### 5.4.1.5.14 *Dangerous goods in excepted quantities*

5.4.1.5.14.1 When dangerous goods are transported according to the exceptions for dangerous goods packed in excepted quantities provided for in column 7b of the Dangerous Goods List and chapter 3.5, the words “dangerous goods in excepted quantities” shall be included.

#### 5.4.1.5.15 *Firework classification reference*

When fireworks of UN Nos. 0333, 0334, 0335, 0336 and 0337 are transported, the dangerous goods transport document shall include a classification reference(s) issued by the competent authority.

The classification reference(s) shall consist of the competent authority's state, indicated by the distinguishing sign used on vehicles in international road traffic,\* the competent authority identification and a unique serial reference. Examples of such classification references are:

- GB/HSE123456
- D/BAM1234
- USA EX20091234.

#### 5.4.1.5.16 *Classification where new data is available (see 2.0.0.2)*

For transport in accordance with 2.0.0.2, a statement to this effect shall be included in the transport document, as follows “Classified in accordance with 2.0.0.2”.

#### 5.4.1.5.17 *Additional entries in the case of the application of special provisions*

Where, in accordance with a special provision in chapter 3.3, additional information is necessary, this additional information shall be included in the dangerous goods transport document.

#### ■ 5.4.1.5.18 *Transport of UN 1361*

For transport of UN 1361, the transport document shall contain the following additional information (see special provision 978 of chapter 3.3):

- .1 Date of production ...
- .2 Date of packing into packagings ...
- .3 Temperature of the material on the day of packing into the packagings ... °C”.

#### 5.4.1.5.19 *Actual holding time*

In the case of portable tanks carrying refrigerated liquefied gases the consignor shall enter in the transport document the date at which the actual holding time ends, in the following format:

“END OF HOLDING TIME:..... (DD/MM/YYYY)”

\* Distinguishing sign of the State of registration used on motor vehicles and trailers in international road traffic, e.g. in accordance with the Geneva Convention on Road Traffic of 1949 or the Vienna Convention on Road Traffic of 1968.



**Part 5 – Consignment procedures****5.4.1.6 Certification**

5.4.1.6.1 The dangerous goods transport document shall include a certification or declaration that the consignment is acceptable for transport and that the goods are properly packaged, marked and labelled, and in proper condition for transport in accordance with the applicable regulations. The text for this certification is:

“I hereby declare that the contents of this consignment are fully and accurately described above/below\* by the proper shipping name, and are classified, packaged, marked and labelled/placarded, and are in all respects in proper condition for transport according to applicable international and national government regulations.”

The certification shall be signed and dated by the consignor. Facsimile signatures are acceptable where applicable laws and regulations recognize the legal validity of facsimile signatures.

5.4.1.6.2 If the dangerous goods documentation is presented to the carrier by means of EDP or EDI transmission techniques, the signature(s) may be electronic signature(s) or may be replaced by the name(s) (in capitals) of the person authorized to sign.

5.4.1.6.3 When the dangerous goods transport information is given to a carrier by EDP or EDI techniques and subsequently the dangerous goods are transferred to a carrier that requires a paper dangerous goods transport document, the carrier shall ensure that the paper document indicates “Original received electronically” and the name of the signatory shall be shown in capital letters.

**5.4.2 Container/vehicle packing certificate**

5.4.2.1 When dangerous goods are packed or loaded into any container<sup>†</sup> or vehicle, those responsible for packing the container or vehicle shall provide a “container/vehicle packing certificate” specifying the container/vehicle identification number(s) and certifying that the operation has been carried out in accordance with the following conditions:

- .1 The container/vehicle was clean, dry and apparently fit to receive the goods;
- .2 Packages which need to be segregated in accordance with applicable segregation requirements have not been packed together onto or in the container/vehicle (unless approved by the competent authority concerned in accordance with 7.3.4.1);
- .3 All packages have been externally inspected for damage, and only sound packages have been loaded;
- .4 Drums have been stowed in an upright position, unless otherwise authorized by the competent authority, and all goods have been properly loaded and, where necessary, adequately braced with securing material to suit the mode(s)<sup>‡</sup> of transport for the intended journey;
- .5 Goods loaded in bulk have been evenly distributed within the container/vehicle;
- .6 For consignments including goods of class 1 other than division 1.4, the container/vehicle is structurally serviceable in accordance with 7.1.2;
- .7 The container/vehicle and packages are properly marked, labelled and placarded, as appropriate;
- .8 When substances presenting a risk of asphyxiation are used for cooling or conditioning purposes (such as dry ice (UN 1845) or nitrogen, refrigerated liquid (UN 1977) or argon, refrigerated liquid (UN 1951)), the container/vehicle is externally marked in accordance with 5.5.3.6; and
- .9 A dangerous goods transport document, as indicated in 5.4.1, has been received for each dangerous goods consignment loaded in the container/vehicle.

**Note:** The container/vehicle packing certificate is not required for portable tanks.

5.4.2.2 The information required in the dangerous goods transport document and the container/vehicle packing certificate may be incorporated into a single document; if not, these documents shall be attached. If the information is incorporated into a single document, the document shall include a signed declaration such as “It is declared that the packing of the goods into the container/vehicle has been carried out in accordance with the applicable provisions”. This declaration shall be dated and the person signing this declaration shall be identified on the document. Facsimile signatures are acceptable where applicable laws and regulations recognize the legal validity of facsimile signatures.

5.4.2.3 If the container/vehicle packing certificate is presented to the carrier by means of EDP or EDI transmission techniques, the signature(s) may be electronic signature(s) or may be replaced by the name(s) (in capitals) of the person authorized to sign.

\* As appropriate.

† See definition of “freight container” in 1.2.1.

‡ See CTU Code.

5.4.2.4 When the container/vehicle packing certificate is given to a carrier by EDP or EDI techniques and subsequently the dangerous goods are transferred to a carrier that requires a paper container/vehicle packing certificate, the carrier shall ensure that the paper document indicates “Original received electronically” and the name of the signatory shall be shown in capital letters.

### 5.4.3 Documentation required aboard the ship

△ 5.4.3.1 Each ship carrying dangerous goods and marine pollutants shall have a special list, manifest\* or stowage plan setting out, in accordance with regulation VII/4.2 of SOLAS, as amended, and with regulation 5.2 of Annex III of MARPOL, the dangerous goods (except dangerous goods in excepted packages of class 7) and marine pollutants and the location thereof. This special list or manifest shall be based on the documentation and certification required in this Code. It shall contain in addition to the information in 5.4.1.4, 5.4.1.5 and, for UN 3359, in 5.5.2.4.1.1, the stowage location and the total quantity of dangerous goods and marine pollutants. A detailed stowage plan, which identifies by primary hazard class(es) and subsidiary hazard(s) and sets out the location of all dangerous goods and marine pollutants, may be used in place of such special list or manifest.

5.4.3.2 Each ship carrying excepted packages of class 7 shall have a special list, manifest or stowage plan setting out these excepted packages and the location thereof. This special list or manifest shall be based upon the documents listed in 5.1.5.4.2.1.

5.4.3.3 A copy of the documents according to 5.4.3.1 and, if applicable, 5.4.3.2 shall be made available before departure to the person or organization designated by the port State authority.

#### 5.4.3.4 Emergency response information

5.4.3.4.1 For consignments of dangerous goods, appropriate information shall be immediately available at all times for use in emergency response to accidents and incidents involving dangerous goods in transport. The information shall be available away from packages containing the dangerous goods and immediately accessible in the event of an incident. Methods of compliance include:

- .1 appropriate entries in the special list, manifest or dangerous goods transport document; or
- .2 provision of a separate document such as a safety data sheet; or
- .3 provision of separate documentation, such as the *Revised Emergency Response Procedures for Ships Carrying Dangerous Goods* (EmS Guide) for use in conjunction with the transport document and the *Medical First Aid Guide for Use in Accidents Involving Dangerous Goods* (MFAG).

### 5.4.4 Other required information and documentation

5.4.4.1 In certain circumstances, special certificates or other documents are required such as:

- .1 a weathering certificate; as required in the individual entries of the Dangerous Goods List;
- △ .2 a certificate exempting a substance, material or article from the provisions of the IMDG Code;
- .3 for new self-reactive substances and organic peroxides or new formulation of currently assigned self-reactive substances and organic peroxides, a statement by the competent authority of the country of origin of the approved classification and conditions of transport.

■ 5.4.4.2 A certificate exempting a substance, material or article from the provisions of the IMDG Code and referred to in a special provision assigned to an individual entry in the Dangerous Goods List shall be submitted together with the cargo information required by SOLAS regulation VI/2.

### 5.4.5 Multimodal Dangerous Goods Form

5.4.5.1 This form meets the requirements of SOLAS, chapter VII, regulation 4, MARPOL, Annex III, regulation 5 and the provisions of this chapter. The information required by the provisions of this chapter is mandatory; however, the layout of this form is not mandatory.

This form may be used as a combined dangerous goods transport document and container/vehicle packing certificate for multimodal carriage of dangerous goods.

\* Refer to *Amendments to the Annex to the Convention on Facilitation of International Maritime Traffic, 1965* (resolution FAL.12(40), adopted on 8 April 2016).



Part 5 – Consignment procedures

MULTIMODAL DANGEROUS GOODS FORM

|   |  |   |   |   |
|---|--|---|---|---|
| 1 Shipper/Consignor/Sender  |  | 2 Transport document number   |   |   |
|   |  | 3 Page 1 of      pages  | 4 Shipper's reference                               | 5 Freight forwarder's reference           |
| 6 Consignee   |  | 7 Carrier (to be completed by the carrier)  |   |   |
|   |  | <b>SHIPPER'S DECLARATION</b><br>I hereby declare that the contents of this consignment are fully and accurately described below by the proper shipping name, and are classified, packaged, marked and labelled/placarded and are in all respects in proper condition for transport according to the applicable international and national governmental regulations. |   |   |
| 8 This shipment is within the limitations prescribed for:<br>(Delete non-applicable)  |  | 9 Additional handling information   |   |   |
| PASSENGER AND CARGO AIRCRAFT      CARGO AIRCRAFT ONLY   |  |   |   |   |
| 10 Vessel/flight No. and date   | 11 Port/place of loading                           |   |   |   |
| 12 Port/place of discharge  | 13 Destination                                     |   |   |   |
| 14 Shipping marks   | Number and kind of packages; description of goods* | Gross mass (kg)   | Net mass (kg)                                       | Cube (m <sup>3</sup> )                    |
|   |  |   |   |   |
| 15 Container identification No./ vehicle registration No.   | 16 Seal number(s)                                  | 17 Container/vehicle size and type  | 18 Tare mass (kg)                                   | 19 Total gross mass (including tare) (kg) |
| <b>CONTAINER/VEHICLE PACKING CERTIFICATE</b><br>I hereby declare that the goods described above have been packed/loaded into the container/vehicle identified above in accordance with the applicable provisions. <sup>†</sup><br><b>MUST BE COMPLETED AND SIGNED FOR ALL CONTAINER/VEHICLE LOADS BY PERSON RESPONSIBLE FOR PACKING/LOADING</b> |  | <b>21 RECEIVING ORGANISATION RECEIPT</b><br>Received the above number of packages/containers/trailers in apparent good order and condition, unless stated hereon:<br>RECEIVING ORGANISATION REMARKS:  |   |   |
| 20 Name of company  |  | Haulier's name  | 22 Name of company (OF SHIPPER PREPARING THIS NOTE) |   |
| Name/status of declarant  |  | Vehicle registration No.  | Name/status of declarant                            |   |
| Place and date  |  | Signature and date  | Place and date                                      |   |
| Signature of declarant  |  | DRIVER'S SIGNATURE  | Signature of declarant                              |   |

\* DANGEROUS GOODS:  
You must specify: UN No., proper shipping name, hazard class, packing group (where assigned), marine pollutant and observe the mandatory requirements under applicable national and international governmental regulations. For the purposes of the IMDG Code, see 5.4.1.4.

† For the purposes of the IMDG Code, see 5.4.2.

5

**Documentary Aspects of the International Transport of Dangerous Goods**  
**Container/Vehicle Packing Certificate**

The signature given overleaf in box 20 must be that of the person controlling the container/vehicle operation.

It is certified that:

The container/vehicle was clean, dry and apparently fit to receive the goods.

If the consignments include goods of class 1, other than division 1.4, the container/vehicle is structurally serviceable.

No incompatible goods have been packed into the container/vehicle unless specially authorized by the competent authority.

All packages have been externally inspected for damage and only sound packages packed.

Drums have been stowed in an upright position unless otherwise authorized by the competent authority.

All packages have been properly packed and secured in the container/vehicle.

When materials are transported in bulk packagings, the cargo has been evenly distributed in the container/vehicle.

The packages and the container/vehicle have been properly marked, labelled and placarded. Any irrelevant mark, labels and placards have been removed.

When substances presenting a risk of asphyxiation are used for cooling or conditioning purposes (such as dry ice (UN 1845) or nitrogen, refrigerated liquid (UN 1977) or argon, refrigerated liquid (UN 1951)), the container/vehicle is externally marked in accordance with 5.5.3.6.

When this Dangerous Goods Form is used as a container/vehicle packing certificate only, not a combined document, a dangerous goods Declaration signed by the shipper or supplier must have been issued/received to cover each dangerous goods consignment packed in the container/vehicle.

**Note:** The container/vehicle packing certificate is not required for tanks.

Part 5 – Consignment procedures

MULTIMODAL DANGEROUS GOODS FORM  
Continuation sheet

|                            |  |    |                 |                                 |                        |
|----------------------------|--|----|-----------------|---------------------------------|------------------------|
| 1 Shipper/Consignor/Sender | 2 Transport document number                        |    |                 |                                 |                        |
|                            | 3 Page   | of | pages           | 4 Shipper's reference           |                        |
|                            |  |    |                 | 5 Freight forwarder's reference |                        |
| 14 Shipping marks          | Number and kind of packages; description of goods* |    | Gross mass (kg) | Net mass (kg)                   | Cube (m <sup>3</sup> ) |
|                            |  |    |                 |                                 |                        |

\* DANGEROUS GOODS:  
You must specify: UN No., proper shipping name, hazard class, packing group (where assigned), marine pollutant and observe the mandatory requirements under applicable national and international governmental regulations. For the purposes of the IMDG Code, see 5.4.1.4.

5

#### **5.4.6 Retention of dangerous goods transport information**

**5.4.6.1** The consignor and the carrier shall retain a copy of the dangerous goods transport document and additional information and documentation as specified in this Code, for a minimum period of three months.

**5.4.6.2** When the documents are kept electronically or in a computer system, the consignor and the carrier shall be able to reproduce them in a printed form.

## Chapter 5.5

### Special provisions

5.5.1 [Reserved]

#### 5.5.2 Special provisions applicable to fumigated cargo transport units (UN 3359)\*

##### 5.5.2.1 General

5.5.2.1.1 Fumigated cargo transport units (UN 3359) containing no other dangerous goods are not subject to any provisions of this Code other than those of this section.

5.5.2.1.2 When the fumigated cargo transport unit is loaded with dangerous goods in addition to the fumigant, any provision of this Code relevant to these goods (including placarding, marking and documentation) applies in addition to the provisions of this section.

5.5.2.1.3 Only cargo transport units that can be closed in such a way that the escape of gas is reduced to a minimum shall be used for the transport of cargo under fumigation.

5.5.2.1.4 The provisions of 3.2 and 5.4.3 apply to all fumigated cargo transport units (UN 3359).

##### 5.5.2.2 Training

Persons engaged in the handling of fumigated cargo transport units shall be trained commensurate with their responsibilities.

##### 5.5.2.3 Marking and placarding

5.5.2.3.1 A fumigated cargo transport unit shall be marked with a warning mark, as specified in 5.5.2.3.2, affixed at each access point in a location where it will be easily seen by persons opening or entering the cargo transport unit. This mark shall remain on the cargo transport unit until the following provisions are met:

- .1 the fumigated cargo transport unit has been ventilated to remove harmful concentrations of fumigant gas; and
- .2 the fumigated goods or materials have been unloaded.

5.5.2.3.2 The fumigation warning mark shall be as shown in the figure below.

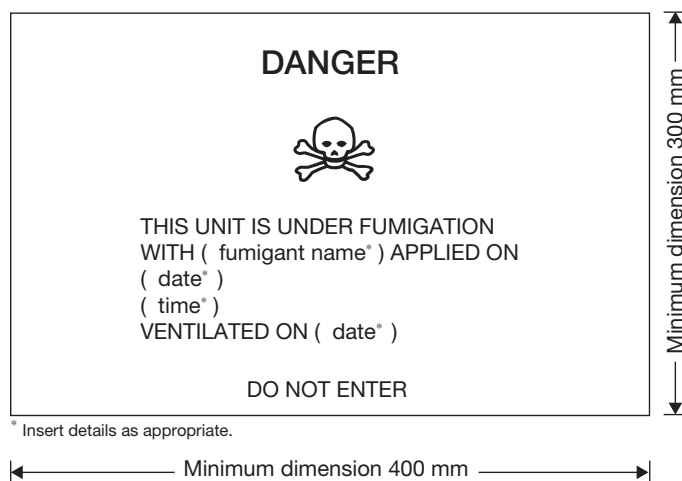

\* Refer to the *Revised recommendations on the safe use of pesticides in ships applicable to the fumigation of cargo transport units* (MSC.1/Circ.1361/Rev.1).

The mark shall be a rectangle. The minimum dimensions shall be 400 mm wide × 300 mm high and the minimum width of the outer line shall be 2 mm. The mark shall be in black print on a white background with lettering not less than 25 mm high. Where dimensions are not specified, all features shall be in approximate proportion to those shown.

The method of marking shall be such that this information will still be identifiable on cargo transport units surviving at least three months' immersion in the sea. In considering suitable marking methods, account shall be taken of the ease with which the surface of the cargo transport unit can be marked.

- **Note:** The fumigation warning mark in 5.5.2.3.2 of the IMDG Code Amendment 41-22, may continue to be applied until 31 December 2026.

- 5.5.2.3.3 If the fumigated cargo transport unit has been completely ventilated either by opening the doors of the unit or by mechanical ventilation after fumigation, the date of ventilation shall be marked on the fumigation warning mark.
- 5.5.2.3.4 When the fumigated cargo transport unit has been ventilated and unloaded, the fumigation warning mark shall be removed.
- 5.5.2.3.5 Class 9 placards (Model No. 9, see 5.2.2.2.2) shall not be affixed to a fumigated cargo transport unit except as required for other class 9 substances or articles packed therein.

#### 5.5.2.4 Documentation

- 5.5.2.4.1 Documents associated with the transport of cargo transport units that have been fumigated and have not been completely ventilated before transport shall include the following information:
  - .1 UN 3359, fumigated cargo transport unit, 9, or UN 3359, fumigated cargo transport unit, class 9;
  - .2 The date and time of fumigation; and
  - .3 The type and amount of the fumigant used.
- 5.5.2.4.2 The transport document may be in any form, provided it contains the information required in 5.5.2.4.1. This information shall be easy to identify, legible and durable.
- 5.5.2.4.3 Instructions for disposal of any residual fumigant including fumigation devices (if used) shall be provided.
- 5.5.2.4.4 A document is not required when the fumigated cargo transport unit has been completely ventilated and the date of ventilation has been marked on the warning mark (see 5.5.2.3.3 and 5.5.2.3.4).

#### 5.5.2.5 Additional provisions

- 5.5.2.5.1 Fumigants shall not be applied to the contents of a cargo transport unit once it has been loaded aboard the ship.
- 5.5.2.5.2 Cargo transport units shall be fumigated in accordance with the requirements determined by the competent authority, to ensure a sufficient period has elapsed to attain a reasonable uniform gas concentration throughout the cargo in it. Twenty-four hours is normally sufficient for this purpose.
- 5.5.2.5.3 The master shall be informed prior to the loading of a fumigated cargo transport unit.

### 5.5.3 Special provisions applicable to packages and cargo transport units containing substances presenting a risk of asphyxiation when used for cooling or conditioning purposes (such as dry ice (UN 1845) or nitrogen, refrigerated liquid (UN 1977) or argon, refrigerated liquid (UN 1951) or nitrogen)

**Note 1:** See also 1.1.1.7.

**Note 2:** In the context of this section the term “conditioning” may be used in a broader scope and includes protection.

#### 5.5.3.1 Scope

- 5.5.3.1.1 This section is not applicable to substances which may be used for cooling or conditioning purposes when transported as a consignment of dangerous goods. When they are transported as a consignment, these substances shall be transported under the relevant entry of the Dangerous Goods List in chapter 3.2 in accordance with the associated conditions of transport.
- 5.5.3.1.2 This section is not applicable to gases in cooling cycles.

**Part 5 – Consignment procedures**

- 5.5.3.1.3 Dangerous goods used for cooling or conditioning portable tanks or MEGCs during transport are not subject to this section.
- 5.5.3.1.4 Cargo transport units containing substances used for cooling or conditioning purposes include cargo transport units containing substances used for cooling or conditioning purposes inside packages as well as cargo transport units with unpackaged substances used for cooling or conditioning purposes.
- 5.5.3.2 **General**
- 5.5.3.2.1 Cargo transport units containing substances used for cooling or conditioning purposes (other than fumigation) during transport are not subject to any provisions of this Code other than those of this section.
- 5.5.3.2.2 When dangerous goods are loaded in cargo transport units containing substances used for cooling or conditioning purposes, any provisions of this Code relevant to these dangerous goods apply in addition to the provisions of this section. For dangerous goods for which temperature control is required see also 7.3.7.
- 5.5.3.2.3 [Reserved]
- 5.5.3.2.4 Persons engaged in the handling or transport of cargo transport units containing substances used for cooling or conditioning purposes shall be trained commensurate with their responsibilities.
- 5.5.3.3 **Packages containing a coolant or conditioner**
- △ 5.5.3.3.1 Packaged dangerous goods requiring cooling or conditioning assigned to packing instructions P203, P620, P650 or P800 of 4.1.4.1 shall meet the appropriate requirements of that packing instruction.
- 5.5.3.3.2 For packaged dangerous goods requiring cooling or conditioning assigned to other packing instructions, the packages shall be capable of withstanding very low temperatures and shall not be affected or significantly weakened by the coolant or conditioner. Packages shall be designed and constructed to permit the release of gas to prevent a build-up of pressure that could rupture the packaging. The dangerous goods shall be packed in such a way to prevent movement after the dissipation of any coolant or conditioner.
- 5.5.3.3.3 Packages containing a coolant or conditioner shall be transported in well-ventilated cargo transport units.
- 5.5.3.4 **Marking of packages containing a coolant or conditioner**
- 5.5.3.4.1 Packages containing dangerous goods used for cooling or conditioning shall be marked with the proper shipping name of these dangerous goods followed by the words “AS COOLANT” or “AS CONDITIONER” as appropriate.
- 5.5.3.4.2 The marks shall be durable, legible and placed in such a location and of such a size relative to the package as to be readily visible.
- 5.5.3.5 **Cargo transport units containing unpackaged dry ice**
- 5.5.3.5.1 If dry ice in unpackaged form is used, it shall not come into direct contact with the metal structure of a cargo transport unit to avoid embrittlement of the metal. Measures shall be taken to provide adequate insulation between the dry ice and the cargo transport unit by providing a minimum of 30 mm separation (e.g. by using suitable low heat conducting materials such as timber planks, pallets, etc.).
- 5.5.3.5.2 Where dry ice is placed around packages, measures shall be taken to ensure that packages remain in the original position during transport after the dry ice has dissipated.
- 5.5.3.6 **Marking of cargo transport units**
- 5.5.3.6.1 Cargo transport units containing dangerous goods used for cooling or conditioning purposes shall be marked with a warning mark, as specified in 5.5.3.6.2 affixed at each access point in a location where it will be easily seen by persons opening or entering the cargo transport unit. This mark shall remain on the cargo transport unit until the following provisions are met:
- .1 the cargo transport unit has been ventilated to remove harmful concentrations of coolant or conditioner; and
  - .2 the cooled or conditioned goods have been unloaded.



5.5.3.6.2 The warning mark shall be as shown in the figure below.



**Asphyxiation warning mark for cargo transport units**

\* Insert proper shipping name or the name of the asphyxiant gas used as the coolant/conditioner. The lettering shall be in capitals, all be on one line and shall be at least 25 mm high. If the length of the proper shipping name is too long to fit in the space provided, the lettering may be reduced to the maximum size possible to fit. For example: CARBON DIOXIDE, SOLID. Additional information such as “AS COOLANT” or “AS CONDITIONER” may be added.

The mark shall be a rectangle. The minimum dimensions shall be 150 mm wide × 250 mm high. The word “WARNING” shall be in red or white and be at least 25 mm high. Where dimensions are not specified, all features shall be in approximate proportion to those shown.

The method of marking shall be such that this information will still be identifiable on cargo transport units surviving at least three months’ immersion in the sea. In considering suitable marking methods, account shall be taken of the ease with which the surface of the cargo transport unit can be marked.

### 5.5.3.7 Documentation

5.5.3.7.1 Documents associated with the transport of cargo transport units containing or having contained substances used for cooling or conditioning purposes and have not been completely ventilated before transport shall include the following information:

- .1 the UN number preceded by the letters “UN”; and
- .2 the proper shipping name followed by the words “AS COOLANT” or “AS CONDITIONER”, as appropriate.

For example: UN 1845, CARBON DIOXIDE, SOLID, AS COOLANT.

5.5.3.7.2 The transport document may be in any form, provided it contains the information required in 5.5.3.7.1. This information shall be easy to identify, legible and durable.

## △ 5.5.4 Devices containing dangerous goods, which are in use or intended for use during transport

5.5.4.1 Devices in use or intended for use during transport containing dangerous goods, such as data loggers, sensors and cargo tracking devices, attached to or placed in packages, overpacks, bulk containers, freight containers or other types of cargo transport units, are not subject to the provisions of this Code other than the requirements set out in 5.5.4.1.1 to 5.5.4.5, as follows:

- .1 the device shall be in use or intended for use during transport;
- .2 the contained dangerous goods (e.g. lithium batteries, fuel cell cartridges) shall meet the applicable construction and test requirements specified in this Code; and
- .3 the device shall be capable of withstanding the shocks and loadings normally encountered during transport and shall be safe for use in the dangerous environments to which it may be exposed.

5.5.4.2 When such device containing dangerous goods is transported as a consignment, the relevant entry of the Dangerous Goods List in chapter 3.2 shall be used and all applicable provisions of this Code shall apply.

5.5.4.3 Data loggers, sensors and cargo tracking devices, attached to packages and overpacks in a closed cargo transport unit are subject to 7.3.5 when dangerous goods are transported in that cargo transport unit.

5.5.4.4 Data loggers, sensors and cargo tracking devices, attached directly to the interior or exterior of cargo transport units shall comply with the following criteria, as found in IEC 60079-0:2017 and IEC 60529:2013:

- .1 Temperature class T4: the device maximum surface temperature attained in service under the most adverse conditions is  $\leq 135^{\circ}\text{C}$ ;
- .2 Equipment group IIB: the device is intended for use in places with an explosive gas atmosphere other than mines susceptible to firedamp and in explosive gas atmospheres other than those containing hydrogen; and
- .3 Degree of protection IP65: the device enclosure protects internal equipment against ingress of dust and protects against harmful effects due to water jets against the enclosure from any direction.

**Note:** For devices in a reefer controller box, the requirement in 5.5.4.4.3 is complied with when the casing of the controller box conforms to 5.5.4.4.3.

5.5.4.5 Devices subject to 5.5.4.4 shall comply with the requirements from 1 January 2028, with the exception for fixed devices on or in reefer containers, which shall comply with these requirements as soon as possible, but not later than 1 January 2032.

# **PART 6**

CONSTRUCTION AND TESTING OF PACKAGINGS,  
INTERMEDIATE BULK CONTAINERS (IBCs),  
LARGE PACKAGINGS, PORTABLE TANKS,  
MULTIPLE-ELEMENT GAS CONTAINERS (MEGCs)  
AND ROAD TANK VEHICLES



## Chapter 6.1

### *Provisions for the construction and testing of packagings*

#### 6.1.1 Applicability and general provisions

##### 6.1.1.1 Applicability

The provisions in this chapter do not apply to:

- .1 pressure receptacles;
- .2 packages containing radioactive material, which shall comply with the Regulations of the International Atomic Energy Agency (IAEA), except that:
  - (i) radioactive material possessing other dangerous properties (subsidiary hazards) shall also comply with special provision 172 in chapter 3.3; and
  - (ii) low specific activity (LSA) material and surface contaminated objects (SCO) may be carried in certain packagings defined in this Code provided that the supplementary provisions set out in the IAEA Regulations are also met;
- .3 packages whose net mass exceeds 400 kg;
- .4 packagings for liquids, other than combination packagings, with capacity exceeding 450 L; and
- .5 packagings for class 6.2 infectious substances of Category A except for UN 3549.

##### 6.1.1.2 General provisions

6.1.1.2.1 The provisions for packagings in 6.1.4 are based on packagings currently used. In order to take into account progress in science and technology, there is no objection to the use of packagings having specifications different from those in 6.1.4, provided that they are equally effective, acceptable to the competent authority and able to successfully fulfil the requirements described in 6.1.1.2 and 6.1.5. Methods of testing other than those described in this chapter are acceptable, provided that they are equivalent.

6.1.1.2.2 Every packaging intended to contain liquids shall successfully undergo a suitable leakproofness test. This test is part of a quality assurance programme as stipulated in 6.1.1.3 which shows the capability of meeting the appropriate test level indicated in 6.1.5.4.4:

- .1 before it is first used for transport;
- .2 after remanufacturing or reconditioning, before it is re-used for transport.

For this test, packagings need not have their own closures fitted.

The inner receptacle of a composite packaging may be tested without the outer packaging provided the test results are not affected. This test is not necessary for an inner packaging of a combination packaging.

6.1.1.2.3 Receptacles, parts of receptacles and closures (stoppers) made of plastics which may be directly in contact with a dangerous substance shall be resistant to it and shall not incorporate materials which may react dangerously or form hazardous compounds or lead to softening, weakening or failure of the receptacle or closure.

6.1.1.2.4 Plastics packagings shall be adequately resistant to ageing and to degradation caused either by the substance contained or by ultraviolet radiation. Any permeation of the substance contained shall not constitute a danger under normal conditions of transport.

6.1.1.3 Packagings shall be manufactured, reconditioned and tested under a quality-assurance programme which satisfies the competent authority in order to ensure that each packaging meets the provisions of this chapter.

**Note:** ISO 16106:2020, *Transport packages for dangerous goods – Dangerous goods packagings, intermediate bulk containers (IBCs) and large packagings – Guidelines for the application of ISO 9001*, provides acceptable guidance on procedures which may be followed.

6.1.1.4 Manufacturers and subsequent distributors of packagings shall provide information regarding procedures to be followed and a description of the types and dimensions of closures (including required gaskets) and any other components needed to ensure that packages as presented for transport are capable of passing the applicable performance tests of this chapter.

Part 6 – Construction and testing of packagings, IBCs, etc.

## 6.1.2 Code for designating types of packagings

6.1.2.1 The code consists of:

- .1 an Arabic numeral indicating the kind of packaging, such as drum, jerrican, etc., followed by
- .2 one or more capital letters in Latin characters indicating the nature of the material, such as steel, wood, etc., followed where necessary by
- .3 an Arabic numeral indicating the category of packaging within the type to which the packaging belongs.

6.1.2.2 In the case of composite packagings, two capital letters in Latin characters shall be used in sequence in the second position of the code. The first indicates the material of the inner receptacle and the second that of the outer packaging.

6.1.2.3 In the case of combination packagings, only the code number for the outer packaging shall be used.

6.1.2.4 The letters 'T', 'V' or 'W' may follow the packaging code. The letter 'T' signifies a salvage packaging conforming to the provisions of 6.1.5.1.11. The letter 'V' signifies a special packaging conforming to the provisions of 6.1.5.1.7. The letter 'W' signifies that the packaging, although of the same type as that indicated by the code, is manufactured to a specification different to that in 6.1.4 but is considered equivalent under the provisions of 6.1.1.2.

6.1.2.5 The following numerals shall be used for the kinds of packaging:

- 1 Drum
- 2 [Reserved]
- 3 Jerrican
- 4 Box
- 5 Bag
- 6 Composite packaging

6.1.2.6 The following capital letters shall be used for the types of material:

- A Steel (all types and surface treatments)
- B Aluminium
- C Natural wood
- D Plywood
- F Reconstituted wood
- G Fibreboard
- H Plastics material
- L Textile
- M Paper, multiwall
- N Metal (other than steel or aluminium)
- P Glass, porcelain or stoneware

**Note:** "Plastics material" is taken to include other polymeric materials such as rubber.

6.1.2.7 The following table indicates the codes to be used for designating types of packagings depending on the kind of packagings, the material used for their construction and their category; it also refers to the paragraphs to be consulted for the appropriate provisions:

| Kind         | Material                               | Category           | Code | Paragraph |
|--------------|--|--------------------|------|-----------|
| 1 Drums      | A Steel                                | non-removable head | 1A1  | 6.1.4.1   |
|              |  | removable head     | 1A2  |           |
|              | B Aluminium                            | non-removable head | 1B1  | 6.1.4.2   |
|              |  | removable head     | 1B2  |           |
|              | D Plywood                              | –                  | 1D   | 6.1.4.5   |
|              | G Fibre                                | –                  | 1G   | 6.1.4.7   |
|              | H Plastics                             | non-removable head | 1H1  | 6.1.4.8   |
|              |  | removable head     | 1H2  |           |
|              | N Metal, other than steel or aluminium | non-removable head | 1N1  | 6.1.4.3   |
|              |  | removable head     | 1N2  |           |
| 2 [Reserved] |  |                    |      |           |

Chapter 6.1 – Provisions for the construction and testing of packagings

| Kind                                   | Material                                   | Category                        | Code     | Paragraph |
|--|--|---------------------------------|----------|-----------|
| 3 Jerricans                            | A Steel                                    | non-removable head              | 3A1      | 6.1.4.4   |
|  |  | removable head                  | 3A2      |           |
|  | B Aluminium                                | non-removable head              | 3B1      | 6.1.4.4   |
|  |  | removable head                  | 3B2      |           |
|  | H Plastics                                 | non-removable head              | 3H1      | 6.1.4.8   |
|  |  | removable head                  | 3H2      |           |
| 4 Boxes                                | A Steel                                    | –                               | 4A       | 6.1.4.14  |
|  | B Aluminium                                | –                               | 4B       | 6.1.4.14  |
|  | C Natural wood                             | ordinary                        | 4C1      | 6.1.4.9   |
|  |  | with sift-proof walls           | 4C2      |           |
|  | D Plywood                                  | –                               | 4D       | 6.1.4.10  |
|  | F Reconstituted wood                       | –                               | 4F       | 6.1.4.11  |
|  | G Fibreboard                               | –                               | 4G       | 6.1.4.12  |
|  | H Plastics                                 | expanded                        | 4H1      | 6.1.4.13  |
|  |  | solid                           | 4H2      |           |
| N Metal, other than steel or aluminium | –  | 4N                              | 6.1.4.14 |           |
| 5 Bags                                 | H Woven plastics                           | without inner lining or coating | 5H1      | 6.1.4.16  |
|  |  | sift-proof                      | 5H2      |           |
|  |  | water-resistant                 | 5H3      |           |
|  | H Plastics film                            | –                               | 5H4      | 6.1.4.17  |
|  | L Textile                                  | without inner lining or coating | 5L1      | 6.1.4.15  |
|  |  | sift-proof                      | 5L2      |           |
|  |  | water-resistant                 | 5L3      |           |
|  | M Paper                                    | multiwall                       | 5M1      | 6.1.4.18  |
|  |  | multiwall, water-resistant      | 5M2      |           |
| 6 Composite packagings                 | H Plastics receptacle                      | in steel drum                   | 6HA1     | 6.1.4.19  |
|  |  | in steel crate or box           | 6HA2     | 6.1.4.19  |
|  |  | in aluminium drum               | 6HB1     | 6.1.4.19  |
|  |  | in aluminium crate or box       | 6HB2     | 6.1.4.19  |
|  |  | in wooden box                   | 6HC      | 6.1.4.19  |
|  |  | in plywood drum                 | 6HD1     | 6.1.4.19  |
|  |  | in plywood box                  | 6HD2     | 6.1.4.19  |
|  |  | in fibre drum                   | 6HG1     | 6.1.4.19  |
|  |  | in fibreboard box               | 6HG2     | 6.1.4.19  |
|  |  | in plastics drum                | 6HH1     | 6.1.4.19  |
|  |  | in solid plastics box           | 6HH2     | 6.1.4.19  |
|  | P Glass, porcelain or stoneware receptacle | in steel drum                   | 6PA1     | 6.1.4.20  |
|  |  | in steel crate or box           | 6PA2     | 6.1.4.20  |
|  |  | in aluminium drum               | 6PB1     | 6.1.4.20  |
|  |  | in aluminium crate or box       | 6PB2     | 6.1.4.20  |
|  |  | in wooden box                   | 6PC      | 6.1.4.20  |
|  |  | in plywood drum                 | 6PD1     | 6.1.4.20  |
|  |  | in wickerwork hamper            | 6PD2     | 6.1.4.20  |
|  |  | in fibre drum                   | 6PG1     | 6.1.4.20  |
|  |  | in fibreboard box               | 6PG2     | 6.1.4.20  |
| in expanded plastics packaging         | 6PH1                                       | 6.1.4.20                        |          |           |
| in solid plastics packaging            | 6PH2                                       | 6.1.4.20                        |          |           |

## Part 6 – Construction and testing of packagings, IBCs, etc.

## 6.1.3 Marking

**Note 1:** The marks indicate that the packaging which bears them correspond to a successfully tested design type and that it complies with the provisions of this chapter which are related to the manufacture, but not to the use, of the packaging. In itself, therefore, the marks do not necessarily confirm that the packaging may be used for any substance. The type of packaging (such as steel drum), its maximum capacity or mass, and any special provisions are specified for each substance or article in part 3 of this Code.

**Note 2:** The marks are intended to be of assistance to packaging manufacturers, reconditioners, packaging users, carriers and regulatory authorities. In relation to the use of a new packaging, the original marks are a means for its manufacturer to identify the type and to indicate those performance test provisions that have been met.

**Note 3:** The marks do not always provide full details of the test levels, etc., and these may need to be taken further into account, such as by reference to a test certificate, test reports or register of successfully tested packagings. For example, a packaging having an X or Y mark may be used for substances to which a packing group having a lesser degree of danger has been assigned, with the relevant maximum permissible value of the relative density\* determined by taking into account the factor 1.5 or 2.25 indicated in the packaging test provisions in 6.1.5 as appropriate, i.e. packing group I packaging tested for products of relative density 1.2 could be used as a packing group II packaging for products of relative density 1.8 or packing group III packaging of relative density 2.7, provided, of course, that all the performance criteria can still be met with the product having the higher relative density.

△ 6.1.3.1 Each packaging intended for use according to this Code shall bear marks on a non-removable component which are durable, legible and placed in such a location and of such a size relative to the packaging as to be readily visible. For packages with a gross mass of more than 30 kg, the marks or a duplicate thereof shall appear on the top or on a side of the packaging. Letters, numerals and symbols shall be at least 12 mm high, except for packagings of 30 L capacity or less or of 30 kg maximum net mass, when they shall be at least 6 mm in height and except for packagings of 5 L capacity or less or of 5 kg maximum net mass when they shall be of an appropriate size.

■ **Note:** The provisions of 6.1.3.1 of the IMDG Code Amendment 41-22 may continue to be applied until 31 December 2026. Packagings manufactured before 1 January 2027 according to the provisions applicable at the date of manufacture may continue to be used.

The marks shall show:

(a) The United Nations packaging symbol:



This symbol shall not be used for any purpose other than certifying that a packaging, a flexible bulk container, a portable tank or a MEGC complies with the relevant requirements in chapters 6.1, 6.2, 6.3, 6.5, 6.6, 6.7 or 6.9. For embossed metal packagings the capital letters “UN” may be applied as the symbol.

(b) The code designating the type of packaging according to 6.1.2.

(c) A code in two parts:

(i) a letter designating the packing group or groups for which the design type has been successfully tested:

“X” for packing groups I, II and III

“Y” for packing groups II and III

“Z” for packing group III only;

(ii) the relative density, rounded off to the first decimal, for which the design type has been tested for packagings, without inner packagings, intended to contain liquids; this may be omitted when the relative density does not exceed 1.2. For packagings intended to contain solids or inner packagings, the maximum gross mass in kilograms.

(d) Either a letter “S”, denoting that the packaging is intended for the transport of solids or inner packagings, or, for packagings (other than combination packagings) intended to contain liquids, the hydraulic test pressure which the packaging was shown to withstand in kilopascals, rounded down to the nearest 10 kPa.

\* Relative density (*d*) is considered to be synonymous with specific gravity (SG) and will be used throughout this text.



## Chapter 6.1 – Provisions for the construction and testing of packagings

- (e) The last two digits of the year during which the packaging was manufactured. Packagings of types 1H and 3H shall also be appropriately marked with the month of manufacture; this may be marked on the packaging in a different place from the remainder of the marks. An appropriate method is:

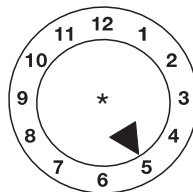

\* The last two digits of the year of manufacture may be displayed at that place. In such a case and when the clock is placed adjacent to the UN design type mark, the indication of the year in the mark may be waived. However, when the clock is not placed adjacent to the UN design type mark, the two digits of the year in the mark and in the clock shall be identical.





**Note:** Other methods that provide the minimum required information in a durable, visible and legible form are also acceptable.

- (f) The State authorizing the allocation of the mark, indicated by the distinguishing sign used on vehicles in international road traffic.\*
- (g) The name of the manufacturer or other identification of the packaging specified by the competent authority.
- 6.1.3.2** In addition to the durable marks prescribed in 6.1.3.1, every new metal drum of a capacity greater than 100 L shall bear the marks described in 6.1.3.1 (a) to (e) on the bottom, with an indication of the nominal thickness of at least the metal used in the body (in millimetres, to 0.1 mm), in permanent form (such as embossed). When the nominal thickness of either head of a metal drum is thinner than that of the body, the nominal thickness of the top head, body and bottom head shall be marked on the bottom in permanent form (such as embossed), for example '1.0 – 1.2 – 1.0' or '0.9 – 1.0 – 1.0'. Nominal thicknesses of metal shall be determined according to the appropriate ISO standard, e.g. ISO 3574:1999 for steel. The marks indicated in 6.1.3.1 (f) and (g) shall not be applied in a permanent form (such as embossed) except as provided in 6.1.3.5.
- 6.1.3.3** Every packaging other than those referred to in 6.1.3.2 liable to undergo a reconditioning process shall bear the marks indicated in 6.1.3.1 (a) to (e) in a permanent form. Marks are permanent if they are able to withstand the reconditioning process (e.g. embossed). For packagings other than metal drums of a capacity greater than 100 L, these permanent marks may replace the corresponding durable markings prescribed in 6.1.3.1.
- 6.1.3.4** For remanufactured metal drums, if there is no change to the packaging type and no replacement or removal of integral structural components, the required marks need not be permanent (such as embossed). Every other remanufactured metal drum shall bear the marks in 6.1.3.1 (a) to (e) in a permanent form (such as embossed) on the top head or side.
- 6.1.3.5** Metal drums made from materials (such as stainless steel) designed to be re-used repeatedly may bear the marks indicated in 6.1.3.1 (f) and (g) in a permanent (such as embossed) form.
- 6.1.3.6** Packagings manufactured with recycled plastics material as defined in 1.2.1 shall be marked "REC". This mark shall be placed near the marks prescribed in 6.1.3.1.
- 6.1.3.7** Marks shall be applied in the sequence of the subparagraphs in 6.1.3.1; each mark required in these subparagraphs and when appropriate subparagraphs (h) to (j) of 6.1.3.8 shall be clearly separated, e.g. by a slash or space, so as to be easily identifiable. For examples, see 6.1.3.10. Any additional marks authorized by a competent authority shall still enable the other marks required in 6.1.3.1 to be correctly identified.
- 6.1.3.8** After reconditioning a packaging, the reconditioner shall apply to it, in sequence, durable marks showing:
- (h) the State in which the reconditioning was carried out, indicated by the distinguishing sign used on vehicles in international road traffic;\*
  - (i) the name of the reconditioner or other identification of the packaging specified by the competent authority;
  - (j) the year of reconditioning; the letter "R"; and, for every packaging successfully passing the leakproofness test in 6.1.1.2.2, the additional letter "L".
- 6.1.3.9** When, after reconditioning, the marks required by 6.1.3.1 (a) to (d) no longer appear on the top head or the side of a metal drum, the reconditioner shall apply them in a durable form followed by those required by 6.1.3.8 (h), (i) and (j). These marks shall not identify a greater performance capability than that for which the original design type has been tested and marked.

\* Distinguishing sign of the State of registration used on motor vehicles and trailers in international road traffic, e.g. in accordance with the Geneva Convention on Road Traffic of 1949 or the Vienna Convention on Road Traffic of 1968.



Part 6 – Construction and testing of packagings, IBCs, etc.

6.1.3.10 Examples for marking for NEW packagings

|  |                 |  |  |
|--|-----------------|--|--|
|   | 4G/Y145/S/02    | as in 6.1.3.1 (a), (b), (c), (d) and (e) | For a new fibreboard box   |
|  | NL/VL823        | as in 6.1.3.1 (f) and (g)                |  |
|   | 1A1/Y1.4/150/98 | as in 6.1.3.1 (a), (b), (c), (d) and (e) | For a new steel drum to contain liquids  |
|  | NL/VL824        | as in 6.1.3.1 (f) and (g)                |  |
|   | 1A2/Y150/S/01   | as in 6.1.3.1 (a), (b), (c), (d) and (e) | For a new steel drum to contain solids or inner packagings                                   |
|  | NL/VL825        | as in 6.1.3.1 (f) and (g)                |  |
|   | 4HW/Y136/S/98   | as in 6.1.3.1 (a), (b), (c), (d) and (e) | For a new plastics box of a specification equivalent to that indicated by the packaging code |
|  | NL/VL826        | as in 6.1.3.1 (f) and (g)                |  |
|  | 1A2/Y/100/01    | as in 6.1.3.1 (a), (b), (c), (d) and (e) | For a remanufactured steel drum to contain liquids of relative density not exceeding 1.2     |
|  | USA/MM5         | as in 6.1.3.1 (f) and (g)                |  |

**Note:** For liquids, the marking of relative density not exceeding 1.2 is optional; see 6.1.3.1 (c)(ii)

6.1.3.11 Examples for marking for RECONDITIONED packagings

|   |                 |  |
|---|-----------------|--|
|  | 1A1/Y1.4/150/97 | as in 6.1.3.1 (a), (b), (c), (d) and (e) |
|   | NL/RB/01 RL     | as in 6.1.3.8 (h), (i) and (j)           |
|  | 1A2/Y150/S/99   | as in 6.1.3.1 (a), (b), (c), (d) and (e) |
|   | USA/RB/00 R     | as in 6.1.3.8 (h), (i) and (j)           |

6.1.3.12 Examples for marking for SALVAGE packagings

|   |                |  |
|---|----------------|--|
|  | 1A2T/Y300/S/01 | as in 6.1.3.1 (a), (b), (c), (d) and (e) |
|   | USA/abc        | as in 6.1.3.1 (f) and (g)                |

**Note:** The marking, for which examples are given in 6.1.3.10, 6.1.3.11 and 6.1.3.12, may be applied in a single line or in multiple lines provided the correct sequence is respected.

6.1.3.13 Where a packaging conforms to one or more than one tested packaging design type, including one or more than one tested IBC or large packaging design type, the packaging may bear more than one mark to indicate the relevant performance test requirements that have been met. Where more than one mark appears on a packaging, the marks shall appear in close proximity to one another and each mark shall appear in its entirety.

## 6.1.4 Provisions for packagings

### 6.1.4.0 General provisions

Any permeation of the substance contained in the packaging shall not constitute a danger under normal conditions of transport.

### 6.1.4.1 Steel drums

1A1 non-removable head

1A2 removable head

6.1.4.1.1 Body and heads shall be constructed of steel sheet of suitable type and adequate thickness in relation to the capacity of the drum and the intended use.

**Note:** For carbon steel drums, “suitable” steels are identified in ISO 3573:1999, *Hot rolled carbon steel sheet of commercial and drawing qualities*, and ISO 3574:1999, *Cold-reduced carbon steel sheet of commercial and drawing qualities*.

For carbon steel drums below 100 L, “suitable” steels in addition to the above standards are also identified in ISO 11949:1995, *Cold-reduced electrolytic tinplate*, ISO 11950:1995, *Cold-reduced electrolytic chromium/chromium oxide-coated steel*, and ISO 11951:1995, *Cold-reduced blackplate in coil form for the production of tinplate or electrolytic chromium/chromium oxide-coated steel*.

6.1.4.1.2 Body seams of drums intended to contain more than 40 L of liquid shall be welded. Body seams of drums intended to contain solids or 40 L or less of liquids shall be mechanically seamed or welded.

6.1.4.1.3 Chimes shall be mechanically seamed or welded. Separate reinforcing rings may be applied.

△ 6.1.4.1.4 Drums may have rolling hoops, either expanded or separate. If there are separate rolling hoops, they shall be fitted tightly on the body and so secured that they cannot shift. Rolling hoops shall not be spot-welded.

6.1.4.1.5 Openings for filling, emptying and venting in the bodies or heads of drums with a non-removable head (1A1) shall not exceed 7 cm in diameter. Drums with larger openings are considered to be of the removable-head type (1A2). Closures for openings in the bodies and heads of drums shall be so designed and applied that they will remain secure and leakproof under normal conditions of transport. Closure flanges may be mechanically seamed or welded in place. Gaskets or other sealing elements shall be used with closures, unless the closure is inherently leakproof.

6.1.4.1.6 Closure devices for removable-head drums shall be so designed and applied that they will remain secure and drums will remain leakproof under normal conditions of transport. Gaskets or other sealing elements shall be used with all removable heads.

6.1.4.1.7 If materials used for body, heads, closures and fittings are not in themselves compatible with the contents to be transported, suitable internal protective coatings or treatments shall be applied. These coatings or treatments shall retain their properties under normal conditions of transport.

6.1.4.1.8 Maximum capacity of drum: 450 L.

6.1.4.1.9 Maximum net mass: 400 kg.

### 6.1.4.2 Aluminium drums

1B1 non-removable head

1B2 removable head

6.1.4.2.1 Body and heads shall be constructed of aluminium at least 99% pure or of an aluminium-based alloy. Material shall be of a suitable type and of adequate thickness in relation to the capacity of the drum and the intended use.

6.1.4.2.2 All seams shall be welded. Chime seams, if any, shall be reinforced by the application of separate reinforcing rings.

△ 6.1.4.2.3 Drums may have rolling hoops, either expanded or separate. If there are separate rolling hoops, they shall be fitted tightly on the body and so secured that they cannot shift. Rolling hoops shall not be spot-welded.

6.1.4.2.4 Openings for filling, emptying and venting in the bodies or heads of drums with a non-removable head (1B1) shall not exceed 7 cm in diameter. Drums with larger openings are considered to be of the removable-head type (1B2). Closures for openings in the bodies and heads of drums shall be so designed and applied that they will remain secure and leakproof under normal conditions of transport. Closure flanges shall be welded in place so that the weld provides a leakproof seam. Gaskets or other sealing elements shall be used with closures, unless the closure is inherently leakproof.

**Part 6 – Construction and testing of packagings, IBCs, etc.**

- 6.1.4.2.5 Closure devices for removable-head drums shall be so designed and applied that they will remain secure and drums will remain leakproof under normal conditions of transport. Gaskets or other sealing elements shall be used with all removable heads.
- 6.1.4.2.6 If materials used for body, heads, closures and fittings are not in themselves compatible with the contents to be transported, suitable internal protective coatings or treatments shall be applied. These coatings or treatments shall retain their protective properties under normal conditions of transport.
- 6.1.4.2.7 Maximum capacity of drum: 450 L.
- 6.1.4.2.8 Maximum net mass: 400 kg.
- 6.1.4.3 **Drums of metal other than aluminium or steel**  
     1N1 non-removable head  
     1N2 removable head
- 6.1.4.3.1 The body and heads shall be constructed of metal or metal alloy other than steel or aluminium. Material shall be of a suitable type and of adequate thickness in relation to the capacity of the drum and to its intended use.
- 6.1.4.3.2 Chime seams, if any, shall be reinforced by the application of separate reinforcing rings. All seams, if any, shall be joined (welded, soldered, etc.) in accordance with the technical state of the art for the used metal or metal alloy.
- △ 6.1.4.3.3 Drums may have rolling hoops, either expanded or separate. If there are separate rolling hoops, they shall be fitted tightly on the body and so secured that they cannot shift. Rolling hoops shall not be spot-welded.
- 6.1.4.3.4 Openings for filling, emptying and venting in the bodies or heads of non-removable-head (1N1) drums shall not exceed 7 cm in diameter. Drums with larger openings are considered to be of the removable-head type (1N2). Closures for openings in the bodies and heads of drums shall be so designed and applied that they will remain secure and leakproof under normal conditions of transport. Closure flanges shall be joined in place (welded, soldered, etc.) in accordance with the technical state of the art for the used metal or metal alloy so that the seam join is leakproof. Gaskets or other sealing elements shall be used with closures, unless the closure is inherently leakproof.
- 6.1.4.3.5 Closure devices for removable-head drums shall be so designed and applied that they will remain secure and drums will remain leakproof under normal conditions of transport. Gaskets or other sealing elements shall be used with all removable heads.
- 6.1.4.3.6 If materials used for body, heads, closures and fittings are not in themselves compatible with the contents to be transported, suitable internal protective coatings or treatments shall be applied. These coatings or treatments shall retain their protective properties under normal conditions of transport.
- 6.1.4.3.7 Maximum capacity of drum: 450 L.
- 6.1.4.3.8 Maximum net mass: 400 kg.
- 6.1.4.4 **Steel or aluminium jerricans**  
     3A1 steel, non-removable head  
     3A2 steel, removable head  
     3B1 aluminium, non-removable head  
     3B2 aluminium, removable head
- 6.1.4.4.1 Body and heads shall be constructed of steel sheet, of aluminium at least 99% pure or of an aluminium-based alloy. Material shall be of a suitable type and of adequate thickness in relation to the capacity of the jerrican and to its intended use.
- 6.1.4.4.2 Chimes of steel jerricans shall be mechanically seamed or welded. Body seams of steel jerricans intended to contain more than 40 L of liquid shall be welded. Body seams of steel jerricans intended to contain 40 L or less shall be mechanically seamed or welded. For aluminium jerricans, all seams shall be welded. Chime seams, if any, shall be reinforced by the application of a separate reinforcing ring.
- 6.1.4.4.3 Openings in jerricans (3A1 and 3B1) shall not exceed 7 cm in diameter. Jerricans with larger openings are considered to be of the removable-head type (3A2 and 3B2). Closures shall be so designed that they will remain secure and leakproof under normal conditions of transport. Gaskets or other sealing elements shall be used with closures, unless the closure is inherently leakproof.
- 6.1.4.4.4 If materials used for body, heads, closures and fittings are not in themselves compatible with the contents to be transported, suitable internal protective coatings or treatments shall be applied. These coatings or treatments shall retain their protective properties under normal conditions of transport.
- 6.1.4.4.5 Maximum capacity of jerrican: 60 L.

## Chapter 6.1 – Provisions for the construction and testing of packagings

- 6.1.4.4.6 Maximum net mass: 120 kg.
- 6.1.4.5 Plywood drums**  
1D
- 6.1.4.5.1 The wood used shall be well seasoned, commercially dry and free from any defect likely to lessen the effectiveness of the drum for the purpose intended. If a material other than plywood is used for the manufacture of the heads, it shall be of a quality equivalent to the plywood.
- 6.1.4.5.2 At least two-ply plywood shall be used for the body and at least three-ply plywood for the heads; the plies shall be firmly glued together by a water-resistant adhesive with their grain crosswise.
- 6.1.4.5.3 The body and heads of the drum and their joins shall be of a design appropriate to the capacity of the drum and its intended use.
- 6.1.4.5.4 In order to prevent sifting of the contents, lids shall be lined with kraft paper or some other equivalent material, which shall be securely fastened to the lid and extend to the outside along its full circumference.
- 6.1.4.5.5 Maximum capacity of drum: 250 L.
- 6.1.4.5.6 Maximum net mass: 400 kg.
- 6.1.4.6 [Reserved]
- 6.1.4.7 Fibre drums**  
1G
- 6.1.4.7.1 The body of the drum shall consist of multiple plies of heavy paper or fibreboard (without corrugations) firmly glued or laminated together and may include one or more protective layers of bitumen, waxed kraft paper, metal foil, plastics material, etc.
- 6.1.4.7.2 Heads shall be of natural wood, fibreboard, metal, plywood, plastics or other suitable material and may include one or more protective layers of bitumen, waxed kraft paper, metal foil, plastics material, etc.
- 6.1.4.7.3 The body and heads of the drum and their joins shall be of a design appropriate to the capacity of the drum and its intended use.
- 6.1.4.7.4 The assembled packaging shall be sufficiently water-resistant so as not to delaminate under normal conditions of transport.
- 6.1.4.7.5 Maximum capacity of drum: 450 L.
- 6.1.4.7.6 Maximum net mass: 400 kg.
- 6.1.4.8 Plastics drums and jerricans**  
1H1 drums, non-removable head  
1H2 drums, removable head  
3H1 jerricans, non-removable head  
3H2 jerricans, removable head
- 6.1.4.8.1 The packaging shall be manufactured from suitable plastics material and be of adequate strength in relation to its capacity and intended use. Except for *recycled plastics material* as defined in 1.2.1, no used material other than production residues or regrind from the same manufacturing process may be used. The packaging shall be adequately resistant to ageing and to degradation caused by the substance contained or by ultraviolet radiation.
- 6.1.4.8.2 If protection against ultraviolet radiation is required, it shall be provided by the addition of carbon black or other suitable pigments or inhibitors. These additives shall be compatible with the contents and remain effective throughout the life of the packaging. Where use is made of carbon black, pigments or inhibitors other than those used in the manufacture of the tested design type, retesting may be waived if the carbon black content does not exceed 2% by mass or if the pigment content does not exceed 3% by mass; the content of inhibitors of ultraviolet radiation is not limited.
- 6.1.4.8.3 Additives serving purposes other than protection against ultraviolet radiation may be included in the composition of the plastics material, provided that they do not adversely affect the chemical and physical properties of the material of the packaging. In such circumstances, retesting may be waived.
- 6.1.4.8.4 The wall thickness at every point of the packaging shall be appropriate to its capacity and intended use, taking into account the stresses to which each point is liable to be exposed.

**Part 6 – Construction and testing of packagings, IBCs, etc.**

- 6.1.4.8.5 Openings for filling, emptying and venting in the bodies or heads of non-removable-head drums (1H1) and jerricans (3H1) shall not exceed 7 cm in diameter. Drums and jerricans with larger openings are considered to be of the removable-head type (1H2 and 3H2). Closures for openings in the bodies or heads of drums and jerricans shall be so designed and applied that they will remain secure and leakproof under normal conditions of transport. Gaskets or other sealing elements shall be used with closures, unless the closure is inherently leakproof.
- 6.1.4.8.6 Closure devices for removable-head drums and jerricans shall be so designed and applied that they will remain secure and leakproof under normal conditions of transport. Gaskets shall be used with all removable heads unless the drum or jerrican design is such that, where the removable head is properly secured, the drum or jerrican is inherently leakproof.
- 6.1.4.8.7 Maximum capacity of drums and jerricans: 1H1, 1H2: 450 L  
3H1, 3H2: 60 L
- 6.1.4.8.8 Maximum net mass: 1H1, 1H2: 400 kg  
3H1, 3H2: 120 kg
- 6.1.4.9 Boxes of natural wood**
- 4C1 ordinary  
4C2 with sift-proof walls
- 6.1.4.9.1 The wood used shall be well seasoned, commercially dry and free from defects that would materially lessen the strength of any part of the box. The strength of the material used and the method of construction shall be appropriate to the capacity and intended use of the box. The tops and bottoms may be made of water-resistant reconstituted wood such as hardboard, particle board or other suitable type.
- 6.1.4.9.2 Fastenings shall be resistant to vibration experienced under normal conditions of transport. Nailing into the end shall be avoided whenever practicable. Joins which are likely to be highly stressed shall be made using clenched or annular ring nails or equivalent fastenings.
- 6.1.4.9.3 Box 4C2: each part shall consist of one piece or be equivalent thereto. Parts are considered equivalent to one piece when one of the following methods of glued assembly is used: Lindermann joint, tongue and groove joint, ship lap or rabbet joint or butt joint, all with at least two corrugated metal fasteners at each joint.
- 6.1.4.9.4 Maximum net mass: 400 kg.
- 6.1.4.10 Plywood boxes**
- 4D
- 6.1.4.10.1 Plywood used shall be at least three-ply. It shall be made from well-seasoned rotary-cut, sliced or sawn veneer, commercially dry and free from defects that would materially lessen the strength of the box. The strength of the material used and the method of construction shall be appropriate to the capacity and intended use of the box. All adjacent plies shall be glued with water-resistant adhesive. Other suitable materials may be used together with plywood in the construction of boxes. Boxes shall be firmly nailed or secured to corner posts or ends or be assembled by equally suitable devices.
- 6.1.4.10.2 Maximum net mass: 400 kg.
- 6.1.4.11 Reconstituted wood boxes**
- 4F
- 6.1.4.11.1 The walls of boxes shall be made of water-resistant reconstituted wood such as hardboard, particle board or other suitable type. The strength of the material used and the method of construction shall be appropriate to the capacity of the boxes and their intended use.
- 6.1.4.11.2 Other parts of the boxes may be made of other suitable material.
- 6.1.4.11.3 Boxes shall be securely assembled by means of suitable devices.
- 6.1.4.11.4 Maximum net mass: 400 kg.
- △ 6.1.4.12 **Fibreboard boxes (including corrugated fibreboard boxes)**
- 4G
- △ 6.1.4.12.1 Strong and good-quality solid or double-faced corrugated fibreboard (single or multiwall) shall be used, appropriate to the capacity of the box and to its intended use. The water resistance of the outer surface shall be such that the increase in mass, as determined in a test carried out over a period of 30 minutes by the Cobb method of determining water absorption, is not greater than 155 g/m<sup>2</sup> – see ISO 535:2014. It shall have proper



## Chapter 6.1 – Provisions for the construction and testing of packagings

bending qualities. Fibreboard shall be cut, creased without scoring, and slotted so as to permit assembly without cracking, surface breaks or undue bending. The fluting of corrugated fibreboard shall be firmly glued to the facings.

- 6.1.4.12.2 The ends of boxes may have a wooden frame or be entirely of wood or other suitable material. Reinforcements of wooden battens or other suitable material may be used.
- 6.1.4.12.3 Manufacturing joins in the body of boxes shall be taped, lapped and glued or lapped and stitched with metal staples. Lapped joins shall have an appropriate overlap.
- 6.1.4.12.4 Where closing is effected by gluing or taping, a water-resistant adhesive shall be used.
- 6.1.4.12.5 Boxes shall be designed so as to provide a good fit to the contents.
- 6.1.4.12.6 Maximum net mass: 400 kg.
- 6.1.4.13 Plastics boxes**
- 4H1 expanded plastics boxes  
4H2 solid plastics boxes
- 6.1.4.13.1 The box shall be manufactured from suitable plastics material and be of adequate strength in relation to its capacity and intended use. The box shall be adequately resistant to ageing and to degradation caused either by the substance contained or by ultraviolet radiation.
- 6.1.4.13.2 An expanded plastics box shall comprise two parts made of a moulded expanded plastics material, a bottom section containing cavities for the inner packagings and a top section covering and interlocking with the bottom section. The top and bottom sections shall be designed so that the inner packagings fit snugly. The closure cap for any inner packaging shall not be in contact with the inside of the top section of this box.
- 6.1.4.13.3 For dispatch, an expanded plastics box shall be closed with a self-adhesive tape having sufficient tensile strength to prevent the box from opening. The adhesive tape shall be weather-resistant and its adhesive compatible with the expanded plastics material of the box. Other closing devices at least equally effective may be used.
- 6.1.4.13.4 For solid plastics boxes, protection against ultraviolet radiation, if required, shall be provided by the addition of carbon black or other suitable pigments or inhibitors. These additives shall be compatible with the contents and remain effective throughout the life of the box. Where use is made of carbon black, pigments or inhibitors other than those used in the manufacture of the tested design type, retesting may be waived if the carbon black content does not exceed 2% by mass or if the pigment content does not exceed 3% by mass; the content of inhibitors of ultraviolet radiation is not limited.
- 6.1.4.13.5 Additives serving purposes other than protection against ultraviolet radiation may be included in the composition of the plastics material provided that they do not adversely affect the chemical and physical properties of the material of the box. In such circumstances, retesting may be waived.
- 6.1.4.13.6 Solid plastics boxes shall have closure devices made of a suitable material of adequate strength and be so designed as to prevent the box from unintentional opening.
- 6.1.4.13.7 Maximum net mass: 4H1: 60 kg  
4H2: 400 kg
- 6.1.4.14 Steel, aluminium or other metal boxes**
- 4A steel boxes  
4B aluminium boxes  
4N metal, other than steel or aluminium, boxes
- 6.1.4.14.1 The strength of the metal and the construction of the box shall be appropriate to the capacity of the box and to its intended use.
- 6.1.4.14.2 Boxes shall be lined with fibreboard or felt packing pieces or shall have an inner liner or coating of suitable material, as required. If a double-seamed metal liner is used, steps shall be taken to prevent the ingress of substances, particularly explosives, into the recesses of the seams.
- 6.1.4.14.3 Closures may be of any suitable type; they shall remain secured under normal conditions of transport.
- 6.1.4.14.4 Maximum net mass: 400 kg.

**Part 6 – Construction and testing of packagings, IBCs, etc.****6.1.4.15 Textile bags**

- 5L1 without inner lining or coating
- 5L2 sift-proof
- 5L3 water-resistant

6.1.4.15.1 The textiles used shall be of good quality. The strength of the fabric and the construction of the bag shall be appropriate to the capacity of the bag and its intended use.

6.1.4.15.2 Bags, sift-proof, 5L2: the bag shall be made sift-proof, for example by the use of:

- .1 paper bonded to the inner surface of the bag by a water-resistant adhesive such as bitumen; or
- .2 plastics film bonded to the inner surface of the bag; or
- .3 one or more inner liners made of paper or plastics material.

6.1.4.15.3 Bags, water-resistant, 5L3: to prevent the entry of moisture, the bag shall be made waterproof, for example by the use of:

- .1 separate inner liners of water-resistant paper (such as waxed kraft paper, tarred paper or plastics-coated kraft paper); or
- .2 plastics film bonded to the inner surface of the bag; or
- .3 one or more inner liners made of plastics material.

6.1.4.15.4 Maximum net mass: 50 kg.

**6.1.4.16 Woven plastics bags**

- 5H1 without inner liner or coating
- 5H2 sift-proof
- 5H3 water-resistant

6.1.4.16.1 Bags shall be made from stretched tapes or monofilaments of a suitable plastics material. The strength of the material used and the construction of the bag shall be appropriate to the capacity of the bag and its intended use.

6.1.4.16.2 If the fabric is woven flat, the bags shall be made by sewing or some other method ensuring closure of the bottom and one side. If the fabric is tubular, the bag shall be closed by sewing, weaving or some other equally strong method of closure.

6.1.4.16.3 Bags, sift-proof, 5H2: the bag shall be made sift-proof, for example by means of:

- .1 paper or a plastics film bonded to the inner surface of the bag; or
- .2 one or more separate inner liners made of paper or plastics material.

6.1.4.16.4 Bags, water-resistant, 5H3: to prevent the entry of moisture, the bag shall be made waterproof, for example by means of:

- .1 separate inner liners of water-resistant paper (such as waxed kraft paper, double-tarred kraft paper or plastics-coated kraft paper); or
- .2 plastics film bonded to the inner or outer surface of the bag; or
- .3 one or more inner plastics liners.

6.1.4.16.5 Maximum net mass: 50 kg.

**6.1.4.17 Plastics film bags**

- 5H4

6.1.4.17.1 Bags shall be made of a suitable plastics material. The strength of the material used and the construction of the bag shall be appropriate to the capacity of the bag and its intended use. Joins and closures shall withstand pressures and impacts liable to occur under normal conditions of transport.

6.1.4.17.2 Maximum net mass: 50 kg.

**6.1.4.18 Paper bags**

- 5M1 multiwall
- 5M2 multiwall, water-resistant

6.1.4.18.1 Bags shall be made of a suitable kraft paper or of an equivalent paper with at least three plies, the middle ply of which may be net-cloth with adhesive bonding to the outermost ply. The strength of the paper and the construction of the bags shall be appropriate to the capacity of the bag and its intended use. Joins and closures shall be sift-proof.



## Chapter 6.1 – Provisions for the construction and testing of packagings

**6.1.4.18.2** Bags 5M2: to prevent the entry of moisture, a bag of four plies or more shall be made waterproof by the use of either a water-resistant ply as one of the two outermost plies or a water-resistant barrier made of a suitable protective material between the two outermost plies; a bag of three plies shall be made waterproof by the use of a water-resistant ply as the outermost ply. Where there is a danger of the substance contained reacting with moisture or where it is packed damp, a waterproof ply or barrier, such as double-tarred kraft paper, plastics-coated kraft paper, plastics film bonded to the inner surface of the bag, or one or more inner plastics liners, shall also be placed next to the substance. Joins and closures shall be waterproof.

**6.1.4.18.3** Maximum net mass: 50 kg.

**6.1.4.19 Composite packagings (plastics material)**

|      |   |
|------|---|
| 6HA1 | plastics receptacle with outer steel drum             |
| 6HA2 | plastics receptacle with outer steel crate or box     |
| 6HB1 | plastics receptacle with outer aluminium drum         |
| 6HB2 | plastics receptacle with outer aluminium crate or box |
| 6HC  | plastics receptacle with outer wooden box             |
| 6HD1 | plastics receptacle with outer plywood drum           |
| 6HD2 | plastics receptacle with outer plywood box            |
| 6HG1 | plastics receptacle with outer fibre drum             |
| 6HG2 | plastics receptacle with outer fibreboard box         |
| 6HH1 | plastics receptacle with outer plastics drum          |
| 6HH2 | plastics receptacle with outer solid plastics box     |

**6.1.4.19.1 Inner receptacle**

- .1 The provisions of 6.1.4.8.1 and 6.1.4.8.3 to 6.1.4.8.6 shall apply to inner plastics receptacles.
- .2 The inner plastics receptacle shall fit snugly inside the outer packaging, which shall be free of any projection that might abrade the plastics material.
- .3 Maximum capacity of inner receptacle:
 

|                                   |       |
|-----------------------------------|-------|
| 6HA1, 6HB1, 6HD1, 6HG1, 6HH1      | 250 L |
| 6HA2, 6HB2, 6HC, 6HD2, 6HG2, 6HH2 | 60 L  |
- .4 Maximum net mass:
 

|                                   |        |
|-----------------------------------|--------|
| 6HA1, 6HB1, 6HD1, 6HG1, 6HH1      | 400 kg |
| 6HA2, 6HB2, 6HC, 6HD2, 6HG2, 6HH2 | 75 kg  |

**6.1.4.19.2 Outer packaging**

- .1 Plastics receptacle with outer steel or aluminium drum (6HA1 or 6HB1): the relevant provisions of 6.1.4.1 or 6.1.4.2, as appropriate, shall apply to the construction of the outer packaging.
- .2 Plastics receptacle with outer steel or aluminium crate or box (6HA2 or 6HB2): the relevant provisions of 6.1.4.14 shall apply to the construction of the outer packaging.
- .3 Plastics receptacle with outer wooden box 6HC: the relevant provisions of 6.1.4.9 shall apply to the construction of the outer packaging.
- .4 Plastics receptacle with outer plywood drum 6HD1: the relevant provisions of 6.1.4.5 shall apply to the construction of the outer packaging.
- .5 Plastics receptacle with outer plywood box 6HD2: the relevant provisions of 6.1.4.10 shall apply to the construction of the outer packaging.
- .6 Plastics receptacle with outer fibre drum 6HG1: the provisions of 6.1.4.7.1 to 6.1.4.7.4 shall apply to the construction of the outer packaging.
- .7 Plastics receptacle with outer fibreboard box 6HG2: the relevant provisions of 6.1.4.12 shall apply to the construction of the outer packaging.
- .8 Plastics receptacle with outer plastics drum 6HH1: the provisions of 6.1.4.8.1 and 6.1.4.8.2 to 6.1.4.8.6 shall apply to the construction of the outer packaging.
- .9 Plastics receptacle with outer solid plastics box (including corrugated plastics material) 6HH2: the provisions of 6.1.4.13.1 and 6.1.4.13.4 to 6.1.4.13.6 shall apply to the construction of the outer packaging.

**6.1.4.20 Composite packagings (glass, porcelain or stoneware)**

|      |  |
|------|--|
| 6PA1 | receptacle with outer steel drum         |
| 6PA2 | receptacle with outer steel crate or box |

**Part 6 – Construction and testing of packagings, IBCs, etc.**

|      |   |
|------|---|
| 6PB1 | receptacle with outer aluminium drum              |
| 6PB2 | receptacle with outer aluminium crate or box      |
| 6PC  | receptacle with outer wooden box                  |
| 6PD1 | receptacle with outer plywood drum                |
| 6PD2 | receptacle with outer wickerwork hamper           |
| 6PG1 | receptacle with outer fibre drum                  |
| 6PG2 | receptacle with outer fibreboard box              |
| 6PH1 | receptacle with outer expanded plastics packaging |
| 6PH2 | receptacle with outer solid plastics packaging    |

**6.1.4.20.1 Inner receptacle**

- .1 Receptacles shall be of a suitable form (cylindrical or pear-shaped) and be made of good-quality material free from any defect that could impair their strength. The walls shall be sufficiently thick at every point.
- .2 Screw-threaded plastics closures, ground glass stoppers or closures at least equally effective shall be used as closures for receptacles. Any part of the closure likely to come into contact with the contents of the receptacle shall be resistant to those contents. Care shall be taken to ensure that the closures are so fitted as to be leakproof and are suitably secured to prevent any loosening during transport. If vented closures are necessary, they shall comply with 4.1.1.8.
- .3 The receptacle shall be firmly secured in the outer packaging by means of cushioning and/or absorbent materials.
- .4 Maximum capacity of receptacle: 60 L.
- .5 Maximum net mass: 75 kg.

**6.1.4.20.2 Outer packaging**

- .1 Receptacle with outer steel drum 6PA1: the relevant provisions of 6.1.4.1 shall apply to the construction of the outer packaging. The removable lid required for this type of packaging may nevertheless be in the form of a cap.
- .2 Receptacle with outer steel crate or box 6PA2: the relevant provisions of 6.1.4.14 shall apply to the construction of the outer packaging. For cylindrical receptacles, the outer packaging shall, when upright, rise above the receptacle and its closure. If the crate surrounds a pear-shaped receptacle and is of matching shape, the outer packaging shall be fitted with a protective cover (cap).
- .3 Receptacle with outer aluminium drum 6PB1: the relevant provisions of 6.1.4.2 shall apply to the construction of the outer packaging.
- .4 Receptacle with outer aluminium crate or box 6PB2: the relevant provisions of 6.1.4.14 shall apply to the construction of the outer packaging.
- .5 Receptacle with outer wooden box 6PC: the relevant provisions of 6.1.4.9 shall apply to the construction of the outer packaging.
- .6 Receptacle with outer plywood drum 6PD1: the relevant provisions of 6.1.4.5 shall apply to the construction of the outer packaging.
- .7 Receptacle with outer wickerwork hamper 6PD2: the wickerwork hamper shall be properly made with material of good quality. It shall be fitted with a protective cover (cap) so as to prevent damage to the receptacle.
- .8 Receptacle with outer fibre drum 6PG1: the relevant provisions of 6.1.4.7.1 to 6.1.4.7.4 shall apply to the body of the outer packaging.
- .9 Receptacle with outer fibreboard box 6PG2: the relevant provisions of 6.1.4.12 shall apply to the construction of the outer packaging.
- .10 Receptacle with outer expanded plastics or solid plastics packaging (6PH1 or 6PH2): the materials of both outer packagings shall meet the relevant provisions of 6.1.4.13. Solid plastics packaging shall be manufactured from high-density polyethylene or some other comparable plastics material. The removable lid for this type of packaging may nevertheless be in the form of a cap.

**6.1.5 Test provisions for packagings****6.1.5.1 Performance and frequency of tests**

**6.1.5.1.1** The design type of each packaging shall be tested as provided in this section, in accordance with procedures established by the competent authority.

**6.1.5.1.2** Each packaging design type shall successfully pass the tests prescribed in this chapter before being used. A packaging design type is defined by the design, size, material and thickness, manner of construction and packing, but may include various surface treatments. It also includes packagings which differ from the design type only in their lesser design height.

## Chapter 6.1 – Provisions for the construction and testing of packagings

- 6.1.5.1.3 Tests shall be repeated on production samples at intervals established by the competent authority. For such tests on paper or fibreboard packagings, preparation at ambient conditions is considered equivalent to the provisions of 6.1.5.2.3.
- 6.1.5.1.4 Tests shall also be repeated after each modification which alters the design, material or manner of construction of a packaging.
- 6.1.5.1.5 The competent authority may permit the selective testing of packagings that differ only in minor respects from a tested type, such as smaller sizes of inner packagings or inner packagings of lower net mass; and packagings such as drums, bags and boxes which are produced with small reductions in external dimensions.
- 6.1.5.1.6 [Reserved]
- Note:** For the conditions for using different inner packagings in an outer packaging and permissible variations in inner packagings, see 4.1.1.5.1. These conditions do not limit the use of inner packagings when applying 6.1.5.1.7.
- 6.1.5.1.7 Articles or inner packagings of any type for solids or liquids may be assembled and transported without testing in an outer packaging under the following conditions:
- .1 The outer packaging shall have been successfully tested in accordance with 6.1.5.3 with fragile (such as glass) inner packagings containing liquids, using the drop height for packing group I.
  - .2 The total combined gross mass of inner packagings shall not exceed one half the gross mass of inner packagings used for the drop test in .1 above.
  - .3 The thickness of the cushioning material between inner packagings and between inner packagings and the outside of the packaging shall not be reduced below the corresponding thicknesses in the originally tested packaging; and when a single inner packaging was used in the original test, the thicknesses of the cushioning between inner packagings shall not be less than the thickness of cushioning between the outside of the packaging and the inner packaging in the original test. When either fewer or smaller inner packagings are used (as compared to the inner packagings used in the drop test), sufficient additional cushioning material shall be used to take up void spaces.
  - .4 The outer packaging shall have successfully passed the stacking test in 6.1.5.6 while empty. The total mass of identical packages shall be based on the combined mass of inner packagings used in the drop test in .1 above.
  - .5 Inner packagings containing liquids shall be completely surrounded with a sufficient quantity of absorbent material to absorb the entire liquid contents of the inner packagings.
  - .6 When the outer packaging is intended to contain inner packagings for liquids and is not leakproof, or is intended to contain inner packagings for solids and is not sift-proof, a means of containing any liquid or solid contents in the event of leakage shall be provided in the form of a leakproof liner, plastics bag or other equally efficient means of containment. For packagings containing liquids, the absorbent material required in .5 above shall be placed inside the means of containing the liquid contents.
  - .7 Packagings shall be marked in accordance with section 6.1.3 as having been tested to packing group I performance for combination packagings. The marked gross mass, in kilograms, shall be the sum of the mass of the outer packaging plus one half of the mass of the inner packaging(s) as used for the drop test referred to in .1 above. Such a packaging mark shall also contain the letter 'V' as described in 6.1.2.4.
- 6.1.5.1.8 The competent authority may at any time require proof, by tests in accordance with this section, that serially produced packagings meet the provisions of the design type tests.
- 6.1.5.1.9 If an inner treatment or coating is required for safety reasons, it shall retain its protective properties after the tests.
- 6.1.5.1.10 Provided the validity of the test results is not affected, and with the approval of the competent authority, several tests may be made on one sample.
- 6.1.5.1.11 **Salvage packagings**
- 6.1.5.1.11.1 Salvage packagings (see 1.2.1) shall be tested and marked in accordance with the provisions applicable to packing group II packagings intended for the transport of solids or inner packagings, except as follows:
- .1 The test substance used in performing the tests shall be water and the packagings shall be filled to not less than 98% of their maximum capacity. It is permissible to use additives, such as bags of lead shot, to achieve the requisite total package mass so long as they are placed in such a way that the test results are not affected. Alternatively, in performing the drop test, the drop height may be varied in accordance with 6.1.5.3.5(b);
  - .2 Packagings shall, in addition, have been successfully subjected to the leakproofness test at 30 kPa, with the results of this test reflected in the test report required by 6.1.5.7; and
  - .3 Packagings shall be marked with the letter 'T' as described in 6.1.2.4.

Part 6 – Construction and testing of packagings, IBCs, etc.

6.1.5.2 Preparation of packagings for testing

6.1.5.2.1 Tests shall be carried out on packagings prepared as for transport, including, with respect to combination packagings, the inner packagings used. Inner or single receptacles or packagings, other than bags, shall be filled to not less than 98% of their maximum capacity for liquids or 95% for solids. Bags shall be filled to the maximum mass at which they may be used. For combination packagings where the inner packaging is designed to carry liquids and solids, separate testing is required for both solid and liquid contents. The substances or articles to be transported in the packagings may be replaced by other substances or articles except where this would invalidate the results of the tests. For solids, when another substance is used, it shall have the same physical characteristics (mass, grain size, etc.) as the substance to be carried. It is permissible to use additives, such as bags of lead shot, to achieve the requisite total package mass, so long as they are placed so that the test results are not affected.

6.1.5.2.2 In the drop tests for liquids, when another substance is used, it shall be of similar relative density and viscosity to those of the substance being transported. Water may also be used for the liquid drop test under the conditions in 6.1.5.3.5.

6.1.5.2.3 Paper or fibreboard packagings shall be conditioned for at least 24 hours in an atmosphere having controlled temperature and relative humidity (r.h.). There are three options, one of which shall be chosen. The preferred atmosphere is 23°C ± 2°C and 50% ± 2% r.h. The two other options are 20°C ± 2°C and 65% ± 2% r.h. or 27°C ± 2°C and 65% ± 2% r.h.

**Note:** Average values shall fall within these limits. Short-term fluctuations and measurement limitations may cause individual measurements to vary by up to ±5% relative humidity without significant impairment of test reproducibility.

6.1.5.2.4 Additional steps shall be taken to ascertain that the plastics material used in the manufacture of plastics drums, plastics jerricans and composite packagings (plastics material) intended to contain liquids complies with the provisions in 6.1.1.2, 6.1.4.8.1 and 6.1.4.8.3. This may be done, for example, by submitting sample receptacles or packagings to a preliminary test extending over a long period, for example six months, during which the samples would remain filled with the substances they are intended to contain and after which the samples shall be submitted to the applicable tests listed in 6.1.5.3, 6.1.5.4, 6.1.5.5, and 6.1.5.6. For substances which may cause stress cracking or weakening in plastics drums or jerricans, the sample, filled with the substance or another substance that is known to have at least as severe stress cracking influence on the plastics materials in question, shall be subjected to a superimposed load equivalent to the total mass of identical packages which might be stacked on it during transport. The minimum height of the stack including the test sample shall be 3 m.

6.1.5.3 Drop test

6.1.5.3.1 *Number of test samples (per design type and manufacturer) and drop orientation*

For other than flat drops, the centre of gravity shall be vertically over the point of impact.

| Packaging   | Number of test samples       | Drop orientation   |
|---|------------------------------|--|
| Steel drums<br>Aluminium drums<br>Metal drums, other than steel or aluminium drums<br>Steel jerricans<br>Aluminium jerricans<br>Plywood drums<br>Fibre drums<br>Plastics drums and jerricans<br>Composite packagings which are in the shape of a drum | Six<br>(three for each drop) | <i>First drop</i> (using three samples): the packaging shall strike the target diagonally on the chime or, if the packaging has no chime, on a circumferential seam or an edge<br><i>Second drop</i> (using the other three samples): the packaging shall strike the target on the weakest part not tested by the first drop, for example a closure or, for some cylindrical drums, the welded longitudinal seam of the body |
| Boxes of natural wood<br>Plywood boxes<br>Reconstituted wood boxes<br>Fibreboard boxes<br>Plastics boxes<br>Steel or aluminium boxes<br>Composite packagings which are in the shape of a box  | Five<br>(one for each drop)  | <i>First drop:</i> flat on the bottom<br><i>Second drop:</i> flat on the top<br><i>Third drop:</i> flat on the long side<br><i>Fourth drop:</i> flat on the short side<br><i>Fifth drop:</i> on a corner   |



Chapter 6.1 – Provisions for the construction and testing of packagings

| Packaging  | Number of test samples         | Drop orientation  |
|--|--------------------------------|---|
| Bags – single-ply with a side seam                 | Three<br>(three drops per bag) | <i>First drop:</i> flat on a wide face<br><i>Second drop:</i> flat on a narrow face<br><i>Third drop:</i> on the end of the bag |
| Bags – single-ply without a side seam or multi-ply | Three<br>(two drops per bag)   | <i>First drop:</i> flat on a wide face<br><i>Second drop:</i> on an end of the bag  |

Where more than one orientation is possible for a given drop test, the orientation most likely to result in failure of the packaging shall be used.

6.1.5.3.2 **Special preparation of test samples for the drop test**

The temperature of the test sample and its contents shall be reduced to –18°C or lower for the following packagings:

- .1 plastics drums (see 6.1.4.8);
- .2 plastics jerricans (see 6.1.4.8);
- .3 plastics boxes other than expanded plastics boxes (see 6.1.4.13);
- .4 composite packagings (plastics material) (see 6.1.4.19); and
- .5 combination packagings with plastics inner packagings, other than plastics bags intended to contain solids or articles.

Where the test samples are prepared in this way, the conditioning in 6.1.5.2.3 may be waived. Test liquids shall be kept in the liquid state by the addition of anti-freeze if necessary.

6.1.5.3.3 Removable head packagings for liquids shall not be dropped until at least 24 h after filling and closing to allow for any possible gasket relaxation.

6.1.5.3.4 **Target**

The target shall be a non-resilient and horizontal surface and shall be:

- .1 integral and massive enough to be immovable;
- .2 flat with a surface kept free from local defects capable of influencing the test results;
- .3 rigid enough to be non-deformable under test conditions and not liable to become damaged by the tests; and
- .4 sufficiently large to ensure that the test package falls entirely upon the surface.

6.1.5.3.5 **Drop height**

For solids and liquids, if the test is performed with the solid or liquid to be carried or with another substance having essentially the same physical characteristics:

| Packing group I | Packing group II | Packing group III |
|-----------------|------------------|-------------------|
| 1.8 m           | 1.2 m            | 0.8 m             |

For liquids in single packagings and for inner packagings of combination packagings, if the test is performed with water:

**Note:** The term “water” includes water/antifreeze solutions with a minimum specific gravity of 0.95 for testing at –18°C.

(a) where the substances to be transported have a relative density not exceeding 1.2:

| Packing group I | Packing group II | Packing group III |
|-----------------|------------------|-------------------|
| 1.8 m           | 1.2 m            | 0.8 m             |

Part 6 – Construction and testing of packagings, IBCs, etc.

(b) where the substances to be transported have a relative density exceeding 1.2, the drop height shall be calculated on the basis of the relative density (*d*) of the substance to be carried, rounded up to the first decimal, as follows:

| Packing group I  | Packing group II | Packing group III |
|------------------|------------------|-------------------|
| $d \times 1.5$ m | $d \times 1.0$ m | $d \times 0.67$ m |

6.1.5.3.6 **Criteria for passing the test**

- .1 Each packaging containing liquid shall be leakproof when equilibrium has been reached between the internal and external pressures, except for inner packagings of combination packagings, when it is not necessary that the pressures be equalized.
- .2 Where a packaging for solids undergoes a drop test and its upper face strikes the target, the test sample passes the test if the entire contents are retained by an inner packaging or inner receptacle (such as a plastics bag), even if the closure, while retaining its containment function, is no longer sift-proof.
- .3 The packaging or outer packaging of a composite or combination packaging shall not exhibit any damage liable to affect safety during transport. Inner receptacles, inner packagings, or articles shall remain completely within the outer packaging and there shall be no leakage of the filling substance from the inner receptacles or inner packaging(s).
- .4 Neither the outermost ply of a bag nor an outer packaging shall exhibit any damage liable to affect safety during transport.
- .5 A slight discharge from the closures upon impact shall not be considered to be a failure of the packaging provided that no further leakage occurs.
- .6 No rupture is permitted in packagings for goods of class 1 which would permit the spillage of loose explosive substances or articles from the outer packaging.

6.1.5.4 **Leakproofness test**

- 6.1.5.4.1 The leakproofness test shall be performed on all design types of packagings intended to contain liquids; however, this test is not required for the inner packagings of combination packagings.
- 6.1.5.4.2 Number of test samples: three test samples per design type and manufacturer.
- 6.1.5.4.3 Special preparation of test samples for the test: vented closures shall either be replaced by similar non-vented closures or the vent shall be sealed.
- 6.1.5.4.4 Test method and pressure to be applied: the packagings, including their closures, shall be restrained under water for 5 minutes while an internal air pressure is applied. The method of restraint shall not affect the results of the test.

The air pressure (gauge) to be applied shall be:

| Packing group I                | Packing group II               | Packing group III              |
|--------------------------------|--------------------------------|--------------------------------|
| Not less than 30 kPa (0.3 bar) | Not less than 20 kPa (0.2 bar) | Not less than 20 kPa (0.2 bar) |

Other methods at least equally as effective may be used.

- 6.1.5.4.5 Criterion for passing the test: there shall be no leakage.

6.1.5.5 **Internal pressure (hydraulic) test**

- 6.1.5.5.1 Packagings to be tested: the internal pressure (hydraulic) test shall be carried out on all design types of metal, plastics and composite packagings intended to contain liquids. This test is not required for inner packagings of combination packagings.
- 6.1.5.5.2 Number of test samples: three test samples per design type and manufacture.
- 6.1.5.5.3 Special preparation of packagings for testing: vented closures shall either be replaced by similar non-vented closures or the vent shall be sealed.
- 6.1.5.5.4 Test method and pressure to be applied: metal packagings and composite packagings (glass, porcelain or stoneware), including their closures, shall be subjected to the test pressure for 5 minutes. Plastics packagings and composite packagings (plastics material), including their closures, shall be subjected to the test pressure for 30 minutes. This pressure is the one to be included in the mark required by 6.1.3.1(d). The manner in which the packagings are supported shall not invalidate the test. The test pressure shall be applied continuously



## Chapter 6.1 – Provisions for the construction and testing of packagings

and evenly; it shall be kept constant throughout the test period. The hydraulic pressure (gauge) applied, as determined by any one of the following methods, shall be:

- .1 not less than the total gauge pressure measured in the packaging (i.e. the vapour pressure of the filling liquid and the partial pressure of the air or other inert gases, minus 100 kPa) at 55°C, multiplied by a safety factor of 1.5; this total gauge pressure shall be determined on the basis of a maximum degree of filling in accordance with 4.1.1.4 and a filling temperature of 15°C;
- .2 not less than 1.75 times the vapour pressure at 50°C of the liquid to be transported, minus 100 kPa, but with a minimum test pressure of 100 kPa;
- .3 not less than 1.5 times the vapour pressure at 55°C of the liquid to be transported minus 100 kPa, but with a minimum test pressure of 100 kPa.

6.1.5.5.5 In addition, packagings intended to contain liquids of packing group I shall be tested to a minimum test pressure of 250 kPa (gauge) for a test period of 5 or 30 minutes, depending upon the material of construction of the packaging.

6.1.5.5.6 Criterion for passing the test: no packaging shall leak.

#### 6.1.5.6 Stacking test

All design types of packagings other than bags shall be subjected to a stacking test.

6.1.5.6.1 Number of test samples: three test samples per design type and manufacturer.

6.1.5.6.2 Test method: the test sample shall be subjected to a force applied to the top surface of the test sample equivalent to the total mass of identical packages which might be stacked on it during transport: where the contents of the test sample are liquids with relative density different from that of the liquid to be transported, the force shall be calculated in relation to the latter. The minimum height of the stack including the test sample shall be 3 m. The duration of the test shall be 24 hours except that plastics drums, jerricans, and composite packagings 6HH1 and 6HH2 intended for liquids shall be subjected to the stacking test for a period of 28 days at a temperature of not less than 40°C.

6.1.5.6.3 Criteria for passing the test: no test sample shall leak. In composite packagings or combination packagings, there shall be no leakage of the filling substance from the inner receptacle or inner packaging. No test sample shall show any deterioration which could adversely affect transport safety or any distortion liable to reduce its strength or cause instability in stacks of packages. Plastics packagings shall be cooled to ambient temperature before the assessment.

#### 6.1.5.7 Test report

6.1.5.7.1 A test report containing at least the following particulars shall be drawn up and shall be available to the users of the packaging:

- .1 name and address of the test facility;
- .2 name and address of applicant (where applicable);
- .3 a unique test report identification;
- .4 date of the test report;
- .5 manufacturer of the packaging;
- .6 description of the packaging design type (such as dimensions, materials, closures, thickness, etc.), including method of manufacture (such as blow-moulding), and which may include drawing(s) and/or photograph(s);
- .7 maximum capacity;
- .8 characteristics of test contents, such as viscosity and relative density for liquids and particle size for solids. For plastics packagings subject to the internal pressure test in 6.1.5.5, the temperature of the water used;
- .9 test descriptions and results;
- .10 signature, with the name and status of the signatory.

6.1.5.7.2 The test report shall contain statements that the packaging prepared as for transport was tested in accordance with the appropriate provisions of this chapter and that the use of other packaging methods or components may render it invalid. A copy of the test report shall be available to the competent authority.

## Chapter 6.2

### *Provisions for the construction and testing of pressure receptacles, aerosol dispensers, small receptacles containing gas (gas cartridges) and fuel cell cartridges containing liquefied flammable gas*

**Note:** Aerosol dispensers, small receptacles containing gas (gas cartridges) and fuel cell cartridges containing liquefied flammable gas are not subject to the provisions of 6.2.1 to 6.2.3.

#### 6.2.1 General provisions

##### 6.2.1.1 Design and construction

6.2.1.1.1 Pressure receptacles shall be designed, manufactured, tested and equipped in such a way as to withstand all conditions, including fatigue, to which they will be subjected during normal conditions of transport and intended use.

6.2.1.1.2 In recognition of scientific and technological advances, and recognizing that pressure receptacles other than those that bear "UN" certification marks may be used on a national or regional basis, pressure receptacles conforming to requirements other than those specified in this Code may be used if approved by the competent authorities in the countries of transport and use.

6.2.1.1.3 In no case shall the minimum wall thickness be less than that specified in the design and construction technical standards.

6.2.1.1.4 For welded pressure receptacles, only metals of weldable quality shall be welded.

6.2.1.1.5 The test pressure of pressure receptacle shells and bundles of cylinders shall be in accordance with packing instruction P200, or, for a chemical under pressure, with packing instruction P206. The test pressure for closed cryogenic receptacles shall be in accordance with packing instruction P203. The test pressure of a metal hydride storage system shall be in accordance with packing instruction P205. The test pressure of a cylinder shell for an adsorbed gas shall be in accordance with packing instruction P208.

6.2.1.1.6 Cylinders or cylinder shells assembled in bundles shall be structurally supported and held together as a unit. Cylinders or cylinder shells shall be secured in a manner that prevents movement in relation to the structural assembly and movement that would result in the concentration of harmful local stresses. Manifold assemblies (e.g. manifold, valves, and pressure gauges) shall be designed and constructed such that they are protected from impact damage and forces normally encountered in transport. Manifolds shall have at least the same test pressure as the cylinders. For toxic liquefied gases, each cylinder shell shall have an isolation valve to ensure that each cylinder can be filled separately and that no interchange of cylinder contents can occur during transport.

6.2.1.1.7 Contact between dissimilar metals which could result in damage by galvanic action shall be avoided.

6.2.1.1.8 The following additional provisions apply to the construction of closed cryogenic receptacles for refrigerated liquefied gases:

- .1 The mechanical properties of the metal used shall be established for each pressure receptacle, including the impact strength and the bending coefficient;
- .2 The pressure receptacles shall be thermally insulated. The thermal insulation shall be protected against impact by means of a jacket. If the space between the inner vessel and the jacket is evacuated of air (vacuum insulation), the jacket shall be designed to withstand, without permanent deformation, an external pressure of at least 100 kPa (1 bar) calculated in accordance with a recognized technical code or a calculated critical collapsing pressure of not less than 200 kPa (2 bar) gauge pressure. If the jacket is so closed as to be gas-tight (e.g. in the case of vacuum insulation), a device shall be provided to prevent any dangerous pressure from developing in the insulating layer in the event of inadequate gas-tightness of the inner vessel or its service equipment. The device shall prevent moisture from penetrating into the insulation.



- .3 Closed cryogenic receptacles intended for the transport of refrigerated liquefied gases having a boiling point below  $-182^{\circ}\text{C}$  at atmospheric pressure shall not include materials which may react with oxygen or oxygen-enriched atmospheres in a dangerous manner, when located in parts of the thermal insulation where there is a risk of contact with oxygen or with oxygen-enriched liquid.
- .4 Closed cryogenic receptacles shall be designed and constructed with suitable lifting and securing arrangements.

#### 6.2.1.1.9 *Additional requirements for the construction of acetylene cylinders*

Cylinder shells for UN 1001 acetylene, dissolved, and UN 3374 acetylene, solvent free, shall be filled with a porous material, uniformly distributed, of a type that conforms to the requirements and testing specified by a standard or technical code recognized by the competent authority and which:

- .1 is compatible with the cylinder shell and does not form harmful or dangerous compounds either with the acetylene or with the solvent in the case of UN 1001; and
- .2 is capable of preventing the spread of decomposition of the acetylene in the porous material.

In the case of UN 1001, the solvent shall be compatible with those parts of the cylinder that are in contact with it.

#### 6.2.1.2 **Materials**

6.2.1.2.1 Construction materials of pressure receptacles which are in direct contact with dangerous goods shall not be affected or weakened by the dangerous goods intended to be transported and shall not cause a dangerous effect, e.g. catalysing a reaction or reacting with the dangerous goods.

6.2.1.2.2 Pressure receptacles shall be made of the materials specified in the design and construction technical standards and the applicable packing instruction for the substances intended for transport in the pressure receptacle. The materials shall be resistant to brittle fracture and to stress corrosion cracking as indicated in the design and construction technical standards.

#### 6.2.1.3 **Service equipment**

6.2.1.3.1 Service equipment subjected to pressure, excluding porous, absorbent or adsorbent material, pressure relief devices, pressure gauges or indicators, shall be designed and constructed so that the burst pressure is at least 1.5 times the test pressure of the pressure receptacle.

6.2.1.3.2 Service equipment shall be configured or designed to prevent damage and unintended opening that could result in the release of the pressure receptacle contents during normal conditions of handling and transport. All closures shall be protected in the same manner as is required for valves in 4.1.6.1.8. Manifold piping leading to shut-off valves shall be sufficiently flexible to protect the shut-off valves and the piping from shearing or releasing the pressure receptacle contents.

6.2.1.3.3 Pressure receptacles which are not capable of being handled manually or rolled shall be fitted with handling devices (skids, rings, straps) ensuring that they can be safely handled by mechanical means and so arranged as not to impair the strength of, nor cause undue stresses in, the pressure receptacle.

6.2.1.3.4 Individual pressure receptacles shall be equipped with pressure relief devices as specified in packing instruction P200(1), P205 or in 6.2.1.3.6.4 and 6.2.1.3.6.5. Pressure relief devices shall be designed to prevent the entry of foreign matter, the leakage of gas and the development of any dangerous excess pressure. When fitted, pressure relief devices on manifolded horizontal pressure receptacles filled with flammable gas shall be arranged to discharge freely to the open air in such a manner as to prevent any impingement of escaping gas upon the pressure receptacle itself under normal conditions of transport.

6.2.1.3.5 Pressure receptacles where filling is measured by volume shall be provided with a level indicator.

#### 6.2.1.3.6 *Additional provisions for closed cryogenic receptacles*

6.2.1.3.6.1 Each filling and discharge opening in a closed cryogenic receptacle used for the transport of flammable refrigerated liquefied gases shall be fitted with at least two mutually independent shut-off devices in series, the first being a stop-valve, the second being a cap or equivalent device.

6.2.1.3.6.2 For sections of piping which can be closed at both ends and where liquid product can be trapped, a method of automatic pressure relief shall be provided to prevent excess pressure build-up within the piping.

6.2.1.3.6.3 Each connection on a closed cryogenic receptacle shall be clearly marked to indicate its function (e.g. vapour or liquid phase).

**Part 6 – Construction and testing of packagings, IBCs, etc.****6.2.1.3.6.4 Pressure relief devices**

6.2.1.3.6.4.1 Each closed cryogenic receptacle shall be provided with at least one pressure relief device. The pressure relief device shall be of the type that will resist dynamic forces, including surge.

6.2.1.3.6.4.2 Closed cryogenic receptacles may, in addition, have a frangible disc in parallel with the spring-loaded device(s) in order to meet the provisions of 6.2.1.3.6.5.

6.2.1.3.6.4.3 Connections to pressure relief devices shall be of sufficient size to enable the required discharge to pass unrestricted to the pressure relief device.

6.2.1.3.6.4.4 All pressure relief device inlets shall, under maximum filling conditions, be situated in the vapour space of the closed cryogenic receptacle and the devices shall be so arranged as to ensure that the escaping vapour is discharged unrestrictedly.

**6.2.1.3.6.5 Capacity and setting of pressure relief devices**

**Note:** In relation to pressure relief devices of closed cryogenic receptacles, “MAWP” means the maximum effective gauge pressure permissible at the top of a loaded closed cryogenic receptacle in its operating position, including the highest effective pressure during filling and discharge.

6.2.1.3.6.5.1 The pressure relief device shall open automatically at a pressure not less than the MAWP and be fully open at a pressure equal to 110% of the MAWP. It shall, after discharge, close at a pressure not lower than 10% below the pressure at which discharge starts and shall remain closed at all lower pressures.

6.2.1.3.6.5.2 Frangible discs shall be set to rupture at a nominal pressure which is the lower of either the test pressure or 150% of the MAWP.

6.2.1.3.6.5.3 In the case of the loss of vacuum in a vacuum-insulated closed cryogenic receptacle, the combined capacity of all pressure relief devices installed shall be sufficient so that the pressure (including accumulation) inside the closed cryogenic receptacle does not exceed 120% of the MAWP.

6.2.1.3.6.5.4 The required capacity of the pressure relief devices shall be calculated in accordance with an established technical code recognized by the competent authority.\*

**6.2.1.4 Approval of pressure receptacles**

6.2.1.4.1 The conformity of pressure receptacles shall be assessed at time of manufacture as required by the competent authority. The technical documentation shall include full specifications on design and construction, and full documentation on the manufacturing and testing.

6.2.1.4.2 Quality assurance systems shall conform to the requirements of the competent authority.

6.2.1.4.3 Pressure receptacle shells and the inner vessels of closed cryogenic receptacles shall be inspected, tested and approved by an inspection body.

6.2.1.4.4 For refillable cylinders, pressure drums and tubes the conformity assessment of the shell and the closure(s) may be carried out separately. In these cases, an additional assessment of the final assembly is not required.

For bundles of cylinders, the cylinder shells and the valve(s) may be assessed separately, but an additional assessment of the complete assembly is required.

For closed cryogenic receptacles, the inner vessels and the closures may be assessed separately, but an additional assessment of the complete assembly is required.

For acetylene cylinders, conformity assessment shall comprise either:

- .1 one assessment of conformity covering both the cylinder shell and the contained porous material; or
- .2 a separate assessment of conformity for the empty cylinder shell and an additional assessment of conformity covering the cylinder shell with the contained porous material.

**6.2.1.5 Initial inspection and test**

6.2.1.5.1 New pressure receptacles, other than closed cryogenic receptacles, metal hydride storage systems and bundles of cylinders, shall be subjected to testing and inspection during and after manufacture in accordance with the applicable design standards or recognized technical codes including the following:

On an adequate sample of pressure receptacle shells:

- .1 testing of the mechanical characteristics of the material of construction;

\* See, for example, CGA S-1.2-2003 – *Pressure Relief Device Standards – Part 2 – Cargo and Portable Tanks for Compressed Gases* and S-1.1-2003 – *Pressure Relief Device Standards – Part 1 – Cylinders for Compressed Gases*.

Chapter 6.2 – Provisions for the construction and testing of receptacles for gases

- .2 verification of the minimum wall thickness;
- .3 verification of the homogeneity of the material for each manufacturing batch;
- .4 inspection of the external and internal conditions;
- .5 inspection of the threads used to fit closures;
- .6 verification of the conformance with the design standard;

For all pressure receptacle shells:

- .7 a hydraulic pressure test. Pressure receptacle shells shall meet the acceptance criteria specified in the design and construction technical standard or technical code;

**Note:** With the agreement of the competent authority, the hydraulic pressure test may be replaced by a test using a gas, where such an operation does not entail any danger.

- .8 inspection and assessment of manufacturing defects and either repairing them or rendering the pressure receptacle shells unserviceable. In the case of welded pressure receptacle shells, particular attention shall be paid to the quality of the welds;
- .9 an inspection of the marks on the pressure receptacle shells;
- .10 in addition, cylinder shells intended for the transport of UN 1001 acetylene, dissolved and UN 3374 acetylene, solvent free shall be inspected to ensure proper installation and condition of the porous material and, if applicable, the quantity of solvent.

On an adequate sample of closures:

- .11 verification of materials;
- .12 verification of dimensions;
- .13 verification of cleanliness;
- .14 inspection of completed assembly; and
- .15 verification of the presence of marks.

For all closures:

- .16 testing for leakproofness.

6.2.1.5.2 Closed cryogenic receptacles shall be subjected to testing and inspection during and after manufacture in accordance with the applicable design standards or recognized technical codes including the following:

On an adequate sample of inner vessels:

- .1 testing of the mechanical characteristics of the material of construction;
- .2 verification of the minimum wall thickness;
- .3 inspection of the external and internal conditions;
- .4 verification of the conformance with the design standard or recognized technical code; and
- .5 inspection of welds by radiographic, ultrasonic or other suitable non-destructive test method according to the applicable design and construction standard or recognized technical code;

For all inner vessels:

- .6 a hydraulic pressure test; the inner vessel shall meet the acceptance criteria specified in the design and construction technical standard or recognized technical code;

**Note:** With the agreement of the competent authority, the hydraulic pressure test may be replaced by a test using a gas, where such an operation does not entail any danger.

- .7 inspection and assessment of manufacturing defects and either repairing them or rendering the inner vessel unserviceable; and
- .8 an inspection of the marks.

On an adequate sample of closures:

- .9 verification of materials;
- .10 verification of dimensions;
- .11 verification of cleanliness;
- .12 inspection of completed assembly; and
- .13 verification of the presence of marks.

For all closures:

- .14 testing for leakproofness.

On an adequate sample of completed closed cryogenic receptacles:

- .15 testing the satisfactory operation of service equipment; and

**Part 6 – Construction and testing of packagings, IBCs, etc.**

.16 verification of the conformance with the design standard or recognized technical code.

△ For all completed closed cryogenic receptacles:

.17 testing for leakproofness.

■ **Note:** Closed cryogenic receptacles which were constructed in accordance with the initial inspection and test requirements of 6.2.1.5.2 applicable in the IMDG Code Amendment 40-20 but which do not however conform to the requirements of 6.2.1.5.2 relating to the initial inspection and test applicable in the IMDG Code Amendment 41-22, may continue to be used.

**6.2.1.5.3** For metal hydride storage systems, it shall be verified that the inspections and tests specified in 6.2.1.5.1.1, .2, .3, .4, .5 if applicable, .6, .7, .8 and .9 have been performed on an adequate sample of the pressure receptacle shells used in the metal hydride storage system. In addition, on an adequate sample of metal hydride storage systems, the inspections and tests specified in 6.2.1.5.1.3 and .6 shall be performed, as well as 6.2.1.5.1.5, if applicable, and inspection of the external conditions of the metal hydride storage system.

Additionally, all metal hydride storage systems shall undergo the initial inspections and tests specified in 6.2.1.5.1.8 and .9, as well as a leakproofness test and a test of the satisfactory operation of the service equipment.

**6.2.1.5.4** For bundles of cylinders the cylinder shells and closures shall be subjected to initial inspection and tests specified in 6.2.1.5.1. An adequate sample of frames shall be proof load tested to two times the maximum gross weight of the bundles of cylinders.

Additionally, all manifolds of bundle of cylinders shall undergo a hydraulic pressure test and all the completed bundles of cylinders shall undergo a leakproofness test.

**Note:** With the agreement of the competent authority, the hydraulic pressure test may be replaced by a test using a gas, where such an operation does not entail any danger.

### **6.2.1.6 Periodic inspection and test**

**6.2.1.6.1** Refillable pressure receptacles, other than cryogenic receptacles, shall be subjected to periodic inspections and tests, by a body authorized by the competent authority, in accordance with the following:

- .1 Check of the external conditions of the pressure receptacle and verification of the equipment and the external marks;
- .2 Check of the internal conditions of the pressure receptacle (e.g. internal inspection, verification of minimum wall thickness);
- .3 Checking of the threads either:
  - .1 if there is evidence of corrosion; or
  - .2 if the closures or other service equipment are removed;
- .4 A hydraulic pressure test of the pressure receptacle shell and, if necessary, verification of the characteristics of the material by suitable tests;

**Note 1:** With the agreement of the competent authority, the hydraulic pressure test may be replaced by a test using a gas, where such an operation does not entail any danger.

■ **Note 2:** For seamless steel cylinder shells and tube shells the check of 6.2.1.6.1.2 and hydraulic pressure test of 6.2.1.6.1.4 may be replaced by a procedure conforming to ISO 16148:2016 + Amd 1:2020 *Gas cylinders – Refillable seamless steel gas cylinders and tubes – Acoustic emission examination (AT) and follow-up ultrasonic examination (UT) for periodic inspection and testing*.

△ **Note 3:** The check of internal conditions of 6.2.1.6.1.2 and the hydraulic pressure test of 6.2.1.6.1.4 may be replaced by ultrasonic examination carried out in accordance with ISO 18119:2018 + Amd 1:2021 for seamless steel and seamless aluminium alloy cylinder shells. For a transitional period until 31 December 2026, the standard ISO 18119:2018 may be used for this same purpose. For a transitional period until 31 December 2024, the standard ISO 10461:2005 + Amd 1:2006 may be used for seamless aluminium alloy cylinder shells and ISO 6406:2005 may be used for seamless steel cylinder shells for this same purpose.

**Note 4:** For bundles of cylinders the hydraulic test specified in .4 above shall be carried out on the cylinder shells and on the manifolds.

- .5 Check of service equipment, if to be reintroduced into service. This check may be carried out separately from the inspection of the pressure receptacle shell.
- .6 A leakproofness test of bundles of cylinders after reassembly.

**Note:** For the periodic inspection and test frequencies, see packing instruction P200 or, for a chemical under pressure, packing instruction P206 of 4.1.4.1.

Chapter 6.2 – Provisions for the construction and testing of receptacles for gases

6.2.1.6.2 Cylinders intended for the transport of UN 1001 acetylene, dissolved and UN 3374 acetylene, solvent free shall be examined only as specified in 6.2.1.6.1.1, 6.2.1.6.1.3 and 6.2.1.6.1.5. In addition, the condition of the porous material (e.g. cracks, top clearance, loosening, or settlement) shall be examined.

6.2.1.6.3 Pressure relief valves for closed cryogenic receptacles shall be subject to periodic inspections and tests.

6.2.1.7 Requirements for manufacturers

6.2.1.7.1 The manufacturer shall be technically able and shall possess all resources required for the satisfactory manufacture of pressure receptacles; this relates in particular to qualified personnel:

- .1 to supervise the entire manufacturing process;
- .2 to carry out joining of materials; and
- .3 to carry out the relevant tests.

6.2.1.7.2 A proficiency test of the manufacturers of pressure receptacle shells and the inner vessels of closed cryogenic receptacles shall in all instances be carried out by an inspection body approved by the competent authority of the country of approval. Proficiency testing of manufacturers of closures shall be carried out if the competent authority requires it. This test shall be carried out either during design type approval or during production inspection and certification.

6.2.1.8 Requirements for inspection bodies

6.2.1.8.1 Inspection bodies shall be independent from manufacturing enterprises and competent to perform the tests, inspections and approvals required.

6.2.2 Provisions for UN pressure receptacles

In addition to the general requirements of 6.2.1, UN pressure receptacles shall comply with the provisions of this section, including the standards, as applicable. Manufacture of new pressure receptacles or service equipment according to any particular standard in 6.2.2.1 and 6.2.2.3 is not permitted after the date shown in the right hand column of the tables.

**Note 1:** With the agreement of the competent authority, more recently published versions of the standards, if available, may be used.

**Note 2:** UN pressure receptacles constructed according to standards applicable at the date of manufacture may continue in use subject to the periodic inspection provisions of this Code.

6.2.2.1 Design, construction and initial inspection and test

6.2.2.1.1 The following standards apply for the design, construction and initial inspection and test of refillable UN cylinder shells, except that inspection requirements related to the conformity assessment system and approval shall be in accordance with 6.2.2.5:

| Reference       | Title  | Applicable for manufacture |
|-----------------|--|----------------------------|
| ISO 9809-1:1999 | Gas cylinders – Refillable seamless steel gas cylinders – Design, construction and testing – Part 1: Quenched and tempered steel cylinders with tensile strength less than 1 100 MPa.<br><b>Note:</b> The note concerning the <i>F</i> factor in section 7.3 of this standard shall not be applied for UN cylinders. | Until 31 December 2018     |
| ISO 9809-1:2010 | Gas cylinders – Refillable seamless steel gas cylinders – Design, construction and testing – Part 1: Quenched and tempered steel cylinders with tensile strength less than 1 100 MPa   | Until 31 December 2026     |
| ISO 9809-1:2019 | Gas cylinders – Design, construction and testing of refillable seamless steel gas cylinders and tubes – Part 1: Quenched and tempered steel cylinders and tubes with tensile strength less than 1 100 MPa  | Until further notice       |
| ISO 9809-2:2000 | Gas cylinders – Refillable seamless steel gas cylinders – Design, construction and testing – Part 2: Quenched and tempered steel cylinders with tensile strength greater than or equal to 1 100 MPa  | Until 31 December 2018     |
| ISO 9809-2:2010 | Gas cylinders – Refillable seamless steel gas cylinders – Design, construction and testing – Part 2: Quenched and tempered steel cylinders with tensile strength greater than or equal to 1 100 MPa  | Until 31 December 2026     |
| ISO 9809-2:2019 | Gas cylinders – Design, construction and testing of refillable seamless steel gas cylinders and tubes – Part 2: Quenched and tempered steel cylinders and tubes with tensile strength greater than or equal to 1 100 MPa   | Until further notice       |



Part 6 – Construction and testing of packagings, IBCs, etc.

| Reference                       | Title   | Applicable for manufacture |
|---------------------------------|---|----------------------------|
| ISO 9809-3:2000                 | Gas cylinders – Refillable seamless steel gas cylinders – Design, construction and testing – Part 3: Normalized steel cylinders   | Until 31 December 2018     |
| ISO 9809-3:2010                 | Gas cylinders – Refillable seamless steel gas cylinders – Design, construction and testing – Part 3: Normalized steel cylinders   | Until 31 December 2026     |
| ISO 9809-3:2019                 | Gas cylinders – Design, construction and testing of refillable seamless steel gas cylinders and tubes – Part 3: Normalized steel cylinders and tubes  | Until further notice       |
| △ ISO 9809-4:2014               | Gas cylinders – Refillable seamless steel gas cylinders – Design, construction and testing – Part 4: Stainless steel cylinders with an Rm value of less than 1 100 MPa  | Until 31 December 2028     |
| ■ ISO 9809-4:2021               | Gas cylinders – Design, construction and testing of refillable seamless steel gas cylinders and tubes – Part 4: Stainless steel cylinders with an Rm value of less than 1 100 MPa<br><b>Note:</b> Small quantities are a batch of cylinders not exceeding 200.  | Until further notice       |
| ISO 7866:1999                   | Gas cylinders – Refillable seamless aluminium alloy gas cylinders – Design, construction and testing<br><b>Note:</b> The note concerning the <i>F</i> factor in section 7.2 of this standard shall not be applied for UN cylinders.<br>Aluminium alloy 6351A-T6 or equivalent shall not be authorized.  | Until 31 December 2020     |
| ISO 7866:2012+ Cor 1:2014       | Gas cylinders – Refillable seamless aluminium alloy gas cylinders – Design, construction and testing<br><b>Note:</b> Aluminium alloy 6351A or equivalent shall not be used.   | Until further notice       |
| ISO 4706:2008                   | Gas cylinders – Refillable welded steel cylinders – Test pressure 60 bar and below  | Until further notice       |
| ISO 18172-1:2007                | Gas cylinders – Refillable welded stainless steel cylinders – Part 1: Test pressure 6 MPa and below   | Until further notice       |
| ISO 20703:2006                  | Gas cylinders – Refillable welded aluminium-alloy cylinders – Design, construction and testing  | Until further notice       |
| ISO 11119-1:2002                | Gas cylinders of composite construction – Specification and test methods – Part 1: Hoop wrapped composite gas cylinders   | Until 31 December 2020     |
| △ ISO 11119-1:2012              | Gas cylinders – Refillable composite gas cylinders and tubes – Design, construction and testing – Part 1: Hoop wrapped fibre reinforced composite gas cylinders and tubes up to 450 l   | Until 31 December 2028     |
| ■ ISO 11119-1:2020              | Gas cylinders – Design, construction and testing of refillable composite gas cylinders and tubes – Part 1: Hoop wrapped fibre reinforced composite gas cylinders and tubes up to 450 l  | Until further notice       |
| ISO 11119-2:2002                | Gas cylinders of composite construction – Specification and test methods – Part 2: Fully wrapped fibre reinforced composite gas cylinders with load-sharing metal liners  | Until 31 December 2020     |
| △ ISO 11119-2:2012 + Amd 1:2014 | Gas cylinders – Refillable composite gas cylinders and tubes – Design, construction and testing – Part 2: Fully wrapped fibre reinforced composite gas cylinders and tubes up to 450 l with load-sharing metal liners   | Until 31 December 2028     |
| ■ ISO 11119-2:2020              | Gas cylinders – Design, construction and testing of refillable composite gas cylinders and tubes – Part 2: Fully wrapped fibre reinforced composite gas cylinders and tubes up to 450 l with load-sharing metal liners  | Until further notice       |
| ISO 11119-3:2002                | Gas cylinders of composite construction – Specification and test methods – Part 3: Fully wrapped fibre reinforced composite gas cylinders with non-load-sharing metallic or non-metallic liners<br><b>Note:</b> This standard shall not be used for linerless cylinders manufactured from two parts joined together.  | Until 31 December 2020     |
| △ ISO 11119-3:2013              | Gas cylinders – Refillable composite gas cylinders and tubes – Design, construction and testing – Part 3: Fully wrapped fibre reinforced composite gas cylinders and tubes up to 450 l with non-load-sharing metallic or non-metallic liners<br><b>Note:</b> This standard shall not be used for linerless cylinders manufactured from two parts joined together. | Until 31 December 2028     |
| ■ ISO 11119-3:2020              | Gas cylinders – Design, construction and testing of refillable composite gas cylinders and tubes – Part 3: Fully wrapped fibre reinforced composite gas cylinders and tubes up to 450 l with non-load-sharing metallic or non-metallic liners or without liners   | Until further notice       |



Chapter 6.2 – Provisions for the construction and testing of receptacles for gases

| Reference        | Title   | Applicable for manufacture |
|------------------|---|----------------------------|
| ISO 11119-4:2016 | Gas cylinders – Refillable composite gas cylinders – Design, construction and testing – Part 4: Fully wrapped fibre reinforced composite gas cylinders up to 150 l with load-sharing welded metallic liners | Until further notice       |

**Note 1:** In the above referenced standards, composite cylinder shells shall be designed for a design life of not less than 15 years.

**Note 2:** Composite cylinder shells with a design life longer than 15 years shall not be filled after 15 years from the date of manufacture, unless the design has successfully passed a service life test programme. The programme shall be part of the initial design type approval and shall specify inspections and tests to demonstrate that composite cylinder shells manufactured accordingly remain safe to the end of their design life. The service life test programme and the results shall be approved by the competent authority of the country of approval that is responsible for the initial approval of the cylinder design. The service life of a composite cylinder shell shall not be extended beyond its initial approved design life.

6.2.2.1.2 The following standards apply for the design, construction and initial inspection and test of UN tube shells, except that inspection requirements related to the conformity assessment system and approval shall be in accordance with 6.2.2.5:

| Reference                     | Title   | Applicable for manufacture |
|-------------------------------|---|----------------------------|
| ISO 11120:1999                | Gas cylinders – Refillable seamless steel tubes for compressed gas transport, of water capacity between 150 l and 3 000 l – Design, construction and testing<br><b>Note:</b> The note concerning the <i>F</i> factor in section 7.1 of this standard shall not be applied for UN tubes.   | Until 31 December 2022     |
| ISO 11120:2015                | Gas cylinders – Refillable seamless steel tubes of water capacity between 150 l and 3 000 l – Design, construction and testing  | Until further notice       |
| ISO 11119-1:2012              | Gas cylinders – Refillable composite gas cylinders and tubes – Design, construction and testing – Part 1: Hoop wrapped fibre reinforced composite gas cylinders and tubes up to 450 l   | Until 31 December 2028     |
| ISO 11119-1:2020              | Gas cylinders – Design, construction and testing of refillable composite gas cylinders and tubes – Part 1: Hoop wrapped fibre reinforced composite gas cylinders and tubes up to 450 l  | Until further notice       |
| ISO 11119-2:2012 + Amd 1:2014 | Gas cylinders – Refillable composite gas cylinders and tubes – Design, construction and testing – Part 2: Fully wrapped fibre reinforced composite gas cylinders and tubes up to 450 l with load-sharing metal liners   | Until 31 December 2028     |
| ISO 11119-2:2020              | Gas cylinders – Design, construction and testing of refillable composite gas cylinders and tubes – Part 2: Fully wrapped fibre reinforced composite gas cylinders and tubes up to 450 l with load-sharing metal liners  | Until further notice       |
| ISO 11119-3:2013              | Gas cylinders – Refillable composite gas cylinders and tubes – Design, construction and testing – Part 3: Fully wrapped fibre reinforced composite gas cylinders and tubes up to 450 l with non-load-sharing metallic or non-metallic liners<br><b>Note:</b> This standard shall not be used for linerless tubes manufactured from two parts joined together. | Until 31 December 2028     |
| ISO 11119-3:2020              | Gas cylinders – Design, construction and testing of refillable composite gas cylinders and tubes – Part 3: Fully wrapped fibre reinforced composite gas cylinders and tubes up to 450 l with non-load-sharing metallic or non-metallic liners or without liners   | Until further notice       |
| ISO 11515: 2013               | Gas cylinders – Refillable composite reinforced tubes of water capacity between 450 l and 3 000 l – Design, construction and testing  | Until 31 December 2026     |
| ISO 11515:2013 + Amd 1:2018   | Gas cylinders – Refillable composite reinforced tubes of water capacity between 450 l and 3 000 l – Design, construction and testing  | Until further notice       |
| ISO 9809-1:2019               | Gas cylinders – Design, construction and testing of refillable seamless steel gas cylinders and tubes – Part 1: Quenched and tempered steel cylinders and tubes with tensile strength less than 1 100 MPa   | Until further notice       |
| ISO 9809-2:2019               | Gas cylinders – Design, construction and testing of refillable seamless steel gas cylinders and tubes – Part 2: Quenched and tempered steel cylinders and tubes with tensile strength greater than or equal to 1 100 MPa  | Until further notice       |
| ISO 9809-3:2019               | Gas cylinders – Design, construction and testing of refillable seamless steel gas cylinders and tubes – Part 3: Normalized steel cylinders and tubes  | Until further notice       |

**Note 1:** In the above referenced standards composite tube shells shall be designed for a design life of not less than 15 years.



Part 6 – Construction and testing of packagings, IBCs, etc.

**Note 2:** Composite tube shells with a design life longer than 15 years shall not be filled after 15 years from the date of manufacture, unless the design has successfully passed a service life test programme. The programme shall be part of the initial design type approval and shall specify inspections and tests to demonstrate that composite tube shells manufactured accordingly remain safe to the end of their design life. The service life test programme and the results shall be approved by the competent authority of the country of approval that is responsible for the initial approval of the tube design. The service life of a composite tube shell shall not be extended beyond its initial approved design life.

6.2.2.1.3 The following standards apply for the design, construction and initial inspection and test of UN acetylene cylinders, except that inspection requirements related to the conformity assessment system and approval shall be in accordance with 6.2.2.5:

For the cylinder shell:

| Reference                  | Title   | Applicable for manufacture |
|----------------------------|---|----------------------------|
| ISO 9809-1:1999            | Gas cylinders – Refillable seamless steel gas cylinders – Design, construction and testing – Part 1: Quenched and tempered steel cylinders with tensile strength less than 1 100 MPa<br><b>Note:</b> The note concerning the <i>F</i> factor in section 7.3 of this standard shall not be applied for UN cylinders. | Until 31 December 2018     |
| ISO 9809-1:2010            | Gas cylinders – Refillable seamless steel gas cylinders – Design, construction and testing – Part 1: Quenched and tempered steel cylinders with tensile strength less than 1 100 MPa  | Until 31 December 2026     |
| ISO 9809-1:2019            | Gas cylinders – Design, construction and testing of refillable seamless steel gas cylinders and tubes – Part 1: Quenched and tempered steel cylinders and tubes with tensile strength less than 1 100 MPa   | Until further notice       |
| ISO 9809-3:2000            | Gas cylinders – Refillable seamless steel gas cylinders – Design, construction and testing – Part 3: Normalized steel cylinders   | Until 31 December 2018     |
| ISO 9809-3:2010            | Gas cylinders – Refillable seamless steel gas cylinders – Design, construction and testing – Part 3: Normalized steel cylinders   | Until 31 December 2026     |
| ISO 9809-3:2019            | Gas cylinders – Design, construction and testing of refillable seamless steel gas cylinders and tubes – Part 3: Normalized steel cylinders and tubes  | Until further notice       |
| ISO 4706:2008              | Gas cylinders – Refillable welded steel cylinders – Test pressure 60 bar and below  | Until further notice       |
| ISO 7866:2012 + Cor 1:2014 | Gas cylinders – Refillable seamless aluminum alloy gas cylinders – Design, construction and testing<br><b>Note:</b> Aluminum alloy 6351A or equivalent shall not be used.   | Until further notice       |

For the acetylene cylinder including the porous material:

| Reference       | Title  | Applicable for manufacture |
|-----------------|--|----------------------------|
| ISO 3807-1:2000 | Cylinders for acetylene – Basic requirements – Part 1: Cylinders without fusible plugs | Until 31 December 2020     |
| ISO 3807-2:2000 | Cylinders for acetylene – Basic requirements – Part 2: Cylinders with fusible plugs    | Until 31 December 2020     |
| ISO 3807-2:2013 | Gas cylinders – Acetylene cylinders – Basic requirements and type testing              | Until further notice       |

6.2.2.1.4 The following standard applies for the design, construction and initial inspection and test of UN closed cryogenic receptacles, except that inspection requirements related to the conformity assessment system and approval shall be in accordance with 6.2.2.5:

| Reference                     | Title  | Applicable for manufacture |
|-------------------------------|--|----------------------------|
| ISO 21029-1:2004              | Cryogenic vessels – Transportable vacuum insulated vessels of not more than 1 000 l volume – Part 1: Design, fabrication, inspection and tests | Until 31 December 2026     |
| ISO 21029-1:2018 + Amd 1:2019 | Cryogenic vessels – Transportable vacuum insulated vessels of not more than 1 000 l volume – Part 1: Design, fabrication, inspection and tests | Until further notice       |

Chapter 6.2 – Provisions for the construction and testing of receptacles for gases

6.2.2.1.5 The following standard applies for the design, construction and initial inspection and test of UN metal hydride storage systems, except that inspection requirements related to the conformity assessment system and approval shall be in accordance with 6.2.2.5:

| Reference      | Title   | Applicable for manufacture |
|----------------|---|----------------------------|
| ISO 16111:2008 | Transportable gas storage devices – Hydrogen absorbed in reversible metal hydride | Until 31 December 2026     |
| ISO 16111:2018 | Transportable gas storage devices – Hydrogen absorbed in reversible metal hydride | Until further notice       |

6.2.2.1.6 The following standard applies for the design, construction and initial inspection and test of UN bundles of cylinders. Each cylinder in a UN bundle of cylinders shall be a UN cylinder or UN cylinder shell complying with the requirements of 6.2.2. The inspection requirements related to the conformity assessment system and approval for UN bundles of cylinders shall be in accordance with 6.2.2.5.

| Reference      | Title  | Applicable for manufacture |
|----------------|--|----------------------------|
| ISO 10961:2010 | Gas cylinders – Cylinder bundles – Design, manufacture, testing and inspection | Until 31 December 2026     |
| ISO 10961:2019 | Gas cylinders – Cylinder bundles – Design, manufacture, testing and inspection | Until further notice       |

**Note:** Changing one or more cylinders or cylinder shells of the same design type, including the same test pressure, in an existing UN bundle of cylinders does not require a new conformity assessment of the existing bundle. Service equipment of the bundle of cylinders can also be replaced without requiring a new conformity assessment if it complies with the design type approval.

6.2.2.1.7 The following standards apply for the design, construction and initial inspection and test of UN cylinders for adsorbed gases except that the inspection requirements related to the conformity assessment system and approval shall be in accordance with 6.2.2.5.

| Reference       | Title   | Applicable for manufacture |
|-----------------|---|----------------------------|
| ISO 11513:2011  | Gas cylinders – Refillable welded steel cylinders containing materials for sub-atmospheric gas packaging (excluding acetylene) – Design, construction, testing, use and periodic inspection               | Until 31 December 2026     |
| ISO 11513:2019  | Gas cylinders – Refillable welded steel cylinders containing materials for sub-atmospheric gas packaging (excluding acetylene) – Design, construction, testing, use and periodic inspection               | Until further notice       |
| ISO 9809-1:2010 | Gas cylinders – Refillable seamless steel gas cylinders – Design, construction and testing – Part 1: Quenched and tempered steel cylinders with tensile strength less than 1 100 MPa                      | Until 31 December 2026     |
| ISO 9809-1:2019 | Gas cylinders – Design, construction and testing of refillable seamless steel gas cylinders and tubes – Part 1: Quenched and tempered steel cylinders and tubes with tensile strength less than 1 100 MPa | Until further notice       |

6.2.2.1.8 The following standards apply for the design, construction and initial inspection and test of UN pressure drums, except that inspection requirements related to the conformity assessment system and approval shall be in accordance with 6.2.2.5:

| Reference                     | Title   | Applicable for manufacture |
|-------------------------------|---|----------------------------|
| ISO 21172-1:2015              | Gas cylinders – Welded steel pressure drums up to 3 000 l capacity for the transport of gases – Design and construction – Part 1: Capacities up to 1 000 l<br><b>Note:</b> Irrespective of section 6.3.3.4 of this standard, welded steel gas pressure drums with dished ends convex to pressure may be used for the transport of corrosive substances provided all applicable requirements of this Code are met. | Until 31 December 2026     |
| ISO 21172-1:2015 + Amd 1:2018 | Gas cylinders – Welded steel pressure drums up to 3 000 l capacity for the transport of gases – Design and construction – Part 1: Capacities up to 1 000 l  | Until further notice       |
| ISO 4706:2008                 | Gas cylinders – Refillable welded steel cylinders – Test pressure 60 bar and below  | Until further notice       |
| ISO 18172-1:2007              | Gas cylinders – Refillable welded stainless steel cylinders – Part 1: Test pressure 6 MPa and below   | Until further notice       |

Part 6 – Construction and testing of packagings, IBCs, etc.

6.2.2.1.9 The following standards apply to the design, construction and initial inspection and test of non-refillable UN cylinders except that the inspection requirements related to the conformity assessment system and approval shall be in accordance with 6.2.2.5.

| Reference                   | Title  | Applicable for manufacture |
|-----------------------------|--|----------------------------|
| ISO 11118:1999              | Gas cylinders – Non-refillable metallic gas cylinders – Specification and test methods                           | Until 31 December 2020     |
| ISO 13340:2001              | Transportable gas cylinders – Cylinder valves for non-refillable cylinders – Specification and prototype testing | Until 31 December 2020     |
| ISO 11118:2015              | Gas cylinders – Non-refillable metallic gas cylinders – Specification and test methods                           | Until 31 December 2026     |
| ISO 11118:2015 + Amd 1:2019 | Gas cylinders – Non-refillable metallic gas cylinders – Specification and test methods                           | Until further notice       |

6.2.2.2 Materials

In addition to the material requirements specified in the design and construction standards, and any restrictions specified in the applicable packing instruction for the gas(es) to be transported (e.g. packing instruction P200 or P205), the following standards apply to material compatibility:

| Reference          | Title  |
|--------------------|--|
| △ ISO 11114-1:2020 | Gas cylinders – Compatibility of cylinder and valve materials with gas contents – Part 1: Metallic materials     |
| △ ISO 11114-2:2021 | Gas cylinders – Compatibility of cylinder and valve materials with gas contents – Part 2: Non-metallic materials |

6.2.2.3 Closures and their protection

The following standards apply to the design, construction, and initial inspection and test of closures and their protection:

| Reference                   | Title   | Applicable for manufacture |
|-----------------------------|---|----------------------------|
| ISO 11117:1998              | Gas cylinders – Valve protection caps and valve guards for industrial and medical gas cylinders – Design, construction and tests                    | Until 31 December 2014     |
| ISO 11117:2008 + Cor 1:2009 | Gas cylinders – Valve protection caps and valve guards – Design, construction and tests   | Until 31 December 2026     |
| ISO 11117:2019              | Gas cylinders – Valve protection caps and guards – Design, construction and tests   | Until further notice       |
| ISO 10297:1999              | Gas cylinders – Refillable gas cylinder valves – Specification and type testing   | Until 31 December 2008     |
| ISO 10297:2006              | Gas cylinders – Refillable gas cylinder valves – Specification and type testing   | Until 31 December 2020     |
| ISO 10297:2014              | Gas cylinders – Cylinder valves – Specification and type testing  | Until 31 December 2022     |
| ISO 10297:2014 + Amd 1:2017 | Gas cylinders – Cylinder valves – Specification and type testing  | Until further notice       |
| ISO 14246:2014              | Gas cylinders – Cylinder valves – Manufacturing tests and examination   | Until 31 December 2024     |
| ISO 14246:2014 + Amd 1:2017 | Gas cylinders – Cylinder valves – Manufacturing tests and examinations  | Until further notice       |
| ISO 17871:2015              | Gas cylinders – Quick-release cylinders valves- Specification and type testing<br><b>Note:</b> This standard shall not be used for flammable gases. | Until 31 December 2026     |
| ISO 17871:2020              | Gas cylinders – Quick-release cylinder valves – Specification and type testing  | Until further notice       |

Chapter 6.2 – Provisions for the construction and testing of receptacles for gases

| Reference        | Title   | Applicable for manufacture |
|------------------|---|----------------------------|
| ISO 17879:2017   | Gas cylinders – Self-closing cylinder valves – Specification and type testing<br><b>Note:</b> This standard shall not be applied to self-closing valves in acetylene cylinders. | Until further notice       |
| ■ ISO 23826:2021 | Gas cylinders – Ball valves – Specification and testing   | Until further notice       |

For UN metal hydride storage systems, the requirements specified in the following standard apply to closures and their protection:

| Reference      | Title   | Applicable for manufacture |
|----------------|---|----------------------------|
| ISO 16111:2008 | Transportable gas storage devices – Hydrogen absorbed in reversible metal hydride | Until 31 December 2026     |
| ISO 16111:2018 | Transportable gas storage devices – Hydrogen absorbed in reversible metal hydride | Until further notice       |

6.2.2.4 Periodic inspection and test

The following standards apply to periodic inspection and testing of UN pressure receptacles:

| Reference                    | Title   | Applicable             |
|------------------------------|---|------------------------|
| ISO 6406:2005                | Seamless steel gas cylinders – Periodic inspection and testing  | Until 31 December 2024 |
| △ ISO 18119:2018             | Gas cylinders – Seamless steel and seamless aluminium-alloy gas cylinders and tubes – Periodic inspection and testing   | Until 31 December 2026 |
| ■ ISO 18119:2018 +Amd 1:2021 | Gas cylinders – Seamless steel and seamless aluminium-alloy gas cylinders and tubes – Periodic inspection and testing   | Until further notice   |
| ISO 10460:2005               | Gas cylinders – Welded carbon-steel gas cylinders – Periodic inspection and testing<br><b>Note:</b> The repair of welds described in clause 12.1 of this standard shall not be permitted. Repairs described in clause 12.2 require the approval of the competent authority which approved the periodic inspection and test body in accordance with 6.2.2.6. | Until 31 December 2024 |
| ISO 10460:2018               | Gas cylinders – Welded aluminium-alloy, carbon and stainless steel gas cylinders – Periodic inspection and testing.   | Until further notice   |
| ISO 10461:2005/ Amd 1:2006   | Seamless aluminium-alloy gas cylinders – Periodic inspection and testing  | Until 31 December 2024 |
| ISO 10462:2013               | Gas cylinders – Acetylene cylinders – Periodic inspection and maintenance   | Until 31 December 2024 |
| ISO 10462:2013 + Amd1:2019   | Gas cylinders – Acetylene cylinders – Periodic inspection and maintenance   | Until further notice   |
| ISO 11513:2011               | Gas cylinders – Refillable welded steel cylinders containing materials for sub-atmospheric gas packaging (excluding acetylene) – Design, construction, testing, use and periodic inspection   | Until 31 December 2024 |
| ISO 11513:2019               | Gas cylinders – Refillable welded steel cylinders containing materials for sub-atmospheric gas packaging (excluding acetylene) – Design, construction, testing, use and periodic inspection   | Until further notice   |
| ISO 11623:2015               | Gas cylinders – Composite construction – Periodic inspection and testing  | Until further notice   |
| ISO 22434:2006               | Transportable gas cylinders – Inspection and maintenance of cylinder valves<br><b>Note:</b> These requirements may be met at times other than at the periodic inspection and test of UN cylinders.  | Until further notice   |
| ISO 20475:2018               | Gas cylinders – Cylinder bundles – Periodic inspection and testing  | Until further notice   |

Part 6 – Construction and testing of packagings, IBCs, etc.

| Reference      | Title   | Applicable           |
|----------------|---|----------------------|
| ISO 23088:2020 | Gas cylinders – Periodic inspection and testing of welded steel pressure drums – Capacities up to 1 000 l | Until further notice |

The following standard applies to the periodic inspection and testing of UN metal hydride storage systems:

| Reference      | Title   | Applicable for manufacture |
|----------------|---|----------------------------|
| ISO 16111:2008 | Transportable gas storage devices – Hydrogen absorbed in reversible metal hydride | Until 31 December 2024     |
| ISO 16111:2018 | Transportable gas storage devices – Hydrogen absorbed in reversible metal hydride | Until further notice       |

6.2.2.5 Conformity assessment system and approval for manufacture of pressure receptacles

6.2.2.5.0 Definitions

For the purposes of this section:

*Conformity assessment system* means a system for competent authority approval of a manufacturer, by pressure receptacle design type approval, approval of manufacturer’s quality system and approval of inspection bodies;

*Design type* means a pressure receptacle design as specified by a particular pressure receptacle standard;

*Verify* means confirm by examination or provision of objective evidence that specified requirements have been fulfilled.

**Note:** In this subsection, when separate assessment is used, the term pressure receptacle shall refer to pressure receptacle, pressure receptacle shell, inner vessel of the closed cryogenic receptacle or closure, as appropriate.

6.2.2.5.1 The requirements of 6.2.2.5 shall be used for the conformity assessments of pressure receptacles. Paragraph 6.2.1.4.3 gives details of which parts of pressure receptacles may be conformity assessed separately. However, the requirements of 6.2.2.5 may be replaced by requirements specified by the competent authority in the following cases:

- .1 conformity assessment of closures;
- .2 conformity assessment of the complete assembly of bundles of cylinders provided the cylinder shells have been conformity assessed in accordance with the requirements of 6.2.2.5; and
- .3 conformity assessment of the complete assembly of closed cryogenic receptacles provided the inner vessel has been conformity assessed in accordance with the requirements of 6.2.2.5.

6.2.2.5.2 General requirements

*Competent authority*

6.2.2.5.2.1 The competent authority that approves the pressure receptacle shall approve the conformity assessment system for the purpose of ensuring that pressure receptacles conform to the provisions of this Code. In instances where the competent authority that approves a pressure receptacle is not the competent authority in the country of manufacture, the marks of the approval country and the country of manufacture shall be indicated in the pressure receptacle marking (see 6.2.2.7 and 6.2.2.8).

The competent authority of the country of approval shall supply, upon request, evidence demonstrating compliance of this conformity assessment system to its counterpart in a country of use.

6.2.2.5.2.2 The competent authority may delegate its functions in this conformity assessment system in whole or in part.

6.2.2.5.2.3 The competent authority shall ensure that a current list of approved inspection bodies and their identity marks and approved manufacturers and their identity marks is available.

*Inspection body*

6.2.2.5.2.4 The inspection body shall be approved by the competent authority for the inspection of pressure receptacles and shall:

- .1 have a staff with an organizational structure, capable, trained, competent, and skilled, to satisfactorily perform its technical functions;



- .2 have access to suitable and adequate facilities and equipment;
- .3 operate in an impartial manner and be free from any influence which could prevent it from doing so;
- .4 ensure commercial confidentiality of the commercial and proprietary activities of the manufacturer and other bodies;
- .5 maintain clear demarcation between actual inspection body functions and unrelated functions;
- .6 operate a documented quality system;
- .7 ensure that the tests and inspections specified in the relevant pressure receptacle standard and in this Code are performed; and
- .8 maintain an effective and appropriate report and record system in accordance with 6.2.2.5.6.

6.2.2.5.2.5 The inspection body shall perform design type approval, pressure receptacle production testing and inspection, and certification to verify conformity with the relevant pressure receptacle standard (see 6.2.2.5.4 and 6.2.2.5.5).

*Manufacturer*

6.2.2.5.2.6 The manufacturer shall:

- .1 operate a documented quality system in accordance with 6.2.2.5.3;
- .2 apply for design type approvals in accordance with 6.2.2.5.4;
- .3 select an inspection body from the list of approved inspection bodies maintained by the competent authority in the country of approval; and
- .4 maintain records in accordance with 6.2.2.5.6.

*Testing laboratory*

6.2.2.5.2.7 The testing laboratory shall have:

- .1 staff with an organizational structure, sufficient in number, competence and skill; and
- .2 suitable and adequate facilities and equipment to perform the tests required by the manufacturing standard to the satisfaction of the inspection body.

6.2.2.5.3 **Manufacturer's quality system**

6.2.2.5.3.1 The quality system shall contain all the elements, requirements and provisions adopted by the manufacturer. It shall be documented in a systematic and orderly manner in the form of written policies, procedures and instructions.

The contents shall in particular include adequate descriptions of:

- .1 the organizational structure and responsibilities of personnel with regard to design and product quality;
- .2 the design control and design verification techniques, processes, and procedures that will be used when designing the pressure receptacles;
- .3 the relevant pressure receptacle manufacturing, quality control, quality assurance and process operation instructions that will be used;
- .4 quality records, such as inspection reports, test data and calibration data;
- .5 management reviews to ensure the effective operation of the quality system arising from the audits in accordance with 6.2.2.5.3.2;
- .6 the process describing how customer requirements are met;
- .7 the process for control of documents and their revision;
- .8 the means for control of non-conforming pressure receptacles, purchased components, in-process and final materials; and
- .9 training programmes and qualification procedures for relevant personnel.

6.2.2.5.3.2 **Audit of the quality system**

The quality system shall be initially assessed to determine whether it meets the requirements in 6.2.2.5.3.1 to the satisfaction of the competent authority.

The manufacturer shall be notified of the results of the audit. The notification shall contain the conclusions of the audit and any corrective actions required.

Periodic audits shall be carried out, to the satisfaction of the competent authority, to ensure that the manufacturer maintains and applies the quality system. Reports of the periodic audits shall be provided to the manufacturer.



**Part 6 – Construction and testing of packagings, IBCs, etc.****6.2.2.5.3.3 Maintenance of the quality system**

The manufacturer shall maintain the quality system as approved in order that it remains adequate and efficient.

The manufacturer shall notify the competent authority that approved the quality system of any intended changes. The proposed changes shall be evaluated in order to determine whether the amended quality system will still satisfy the requirements in 6.2.2.5.3.1.

**6.2.2.5.4 Approval process***Initial design type approval*

**6.2.2.5.4.1** The initial design type approval shall consist of approval of the manufacturer's quality system and approval of the pressure receptacle design to be produced. An application for an initial design type approval shall meet the requirements of 6.2.2.5.3, 6.2.2.5.4.2 to 6.2.2.5.4.6 and 6.2.2.5.4.9.

**6.2.2.5.4.2** A manufacturer desiring to produce pressure receptacles in accordance with a pressure receptacle standard and this Code shall apply for, obtain, and retain a Design Type Approval Certificate issued by the competent authority in the country of approval for at least one pressure receptacle design type in accordance with the procedure given in 6.2.2.5.4.9. This certificate shall, on request, be submitted to the competent authority of the country of use.

**6.2.2.5.4.3** An application shall be made for each manufacturing facility and shall include:

- .1 the name and registered address of the manufacturer and in addition, if the application is submitted by an authorized representative, its name and address;
- .2 the address of the manufacturing facility (if different from the above);
- .3 the name and title of the person(s) responsible for the quality system;
- .4 the designation of the pressure receptacle and the relevant pressure receptacle standard;
- .5 details of any refusal of approval of a similar application by any other competent authority;
- .6 the identity of the inspection body for design type approval;
- .7 documentation on the manufacturing facility as specified under 6.2.2.5.3.1; and
- .8 the technical documentation required for design type approval, which shall enable verification of the conformity of the pressure receptacles with the requirements of the relevant pressure receptacle design standard. The technical documentation shall cover the design and method of manufacture and shall contain, as far as is relevant for assessment, at least the following:
  - .1 pressure receptacle design standard, design and manufacturing drawings, showing components and sub-assemblies, if any;
  - .2 descriptions and explanations necessary for the understanding of the drawings and intended use of the pressure receptacles;
  - .3 a list of the standards necessary to fully define the manufacturing process;
  - .4 design calculations and material specifications; and
  - .5 design type approval test reports, describing the results of examinations and tests carried out in accordance with 6.2.2.5.4.9.

**6.2.2.5.4.4** An initial audit in accordance with 6.2.2.5.3.2 shall be performed to the satisfaction of the competent authority.

**6.2.2.5.4.5** If the manufacturer is denied approval, the competent authority shall provide written detailed reasons for such denial.

**6.2.2.5.4.6** Following approval, changes to the information submitted under 6.2.2.5.4.3 relating to the initial approval shall be provided to the competent authority.

*Subsequent design type approvals*

**6.2.2.5.4.7** An application for a subsequent design type approval shall encompass the requirements of 6.2.2.5.4.8 and 6.2.2.5.4.9, provided a manufacturer is in the possession of an initial design type approval. In such a case, the manufacturer's quality system according to 6.2.2.5.3 shall have been approved during the initial design type approval and shall be applicable for the new design.

**6.2.2.5.4.8** The application shall include:

- .1 the name and address of the manufacturer and in addition, if the application is submitted by an authorized representative, its name and address;
- .2 details of any refusal of approval of a similar application by any other competent authority;
- .3 evidence that initial design type approval has been granted; and
- .4 the technical documentation, as described in 6.2.2.5.4.3.8.



*Procedure for design type approval***6.2.2.5.4.9** The inspection body shall:

- .1 examine the technical documentation to verify that:
  - .1 the design is in accordance with the relevant provisions of the standard, and
  - .2 the prototype lot has been manufactured in conformity with the technical documentation and is representative of the design;
- .2 verify that the production inspections have been carried out as required in accordance with 6.2.2.5.5;
- .3 as required by the pressure receptacle standard or technical code, carry out or supervise the tests of pressure receptacles as required for design type approval;
- .4 perform or have performed the examinations and tests specified in the pressure receptacle standard to determine that:
  - .1 the standard has been applied and fulfilled, and
  - .2 the procedures adopted by the manufacturer meet the requirements of the standard; and
- .5 ensure that the various type approval examinations and tests are correctly and competently carried out.

After prototype testing has been carried out with satisfactory results and all applicable requirements of 6.2.2.5.4 have been satisfied, a Design Type Approval Certificate shall be issued which shall include the name and address of the manufacturer, results and conclusions of the examination, and the necessary data for identification of the design type. If it was not possible to evaluate exhaustively the compatibility of the materials of construction with the contents of the pressure receptacle when the certificate was issued, a statement that compatibility assessment was not completed shall be included in the design type approval certificate.

If the manufacturer is denied a design type approval, the competent authority shall provide written detailed reasons for such denial.

**6.2.2.5.4.10** *Modifications to approved design types*

The manufacturer shall either:

- (a) inform the issuing competent authority of modifications to the approved design type, where such modifications do not constitute a new design, as specified in the pressure receptacle standard; or
- (b) request a subsequent design type approval where such modifications constitute a new design according to the relevant pressure receptacle standard. This additional approval shall be given in the form of an amendment to the original design type approval certificate.

**6.2.2.5.4.11** Upon request, the competent authority shall communicate to any other competent authority information concerning design type approval, modifications of approvals, and withdrawn approvals.**6.2.2.5.5** *Production inspection and certification*

An inspection body, or its delegate, shall carry out the inspection and certification of each pressure receptacle. The inspection body selected by the manufacturer for inspection and testing during production may be different from the inspection body used for the design type approval testing.

Where it can be demonstrated to the satisfaction of the inspection body that the manufacturer has trained and competent inspectors, independent of the manufacturing operations, inspection may be performed by those inspectors. In such a case, the manufacturer shall maintain training records of the inspectors.

The inspection body shall verify that the inspections by the manufacturer and tests performed on those pressure receptacles fully conform to the standard and the provisions of this Code. Should non-conformance in conjunction with this inspection and testing be determined, the permission to have inspection performed by the manufacturer's inspectors may be withdrawn.

The manufacturer shall, after approval by the inspection body, make a declaration of conformity with the certified design type. The application of the pressure receptacle certification marks shall be considered a declaration that the pressure receptacle complies with the applicable pressure receptacle standards and the requirements of this conformity assessment system and with the provisions of this Code. The inspection body shall affix or delegate the manufacturer to affix the pressure receptacle certification marks and the registered mark of the inspection body to each approved pressure receptacle.

A certificate of compliance, signed by the inspection body and the manufacturer, shall be issued before the pressure receptacles are filled.

**Part 6 – Construction and testing of packagings, IBCs, etc.****6.2.2.5.6 Records**

Design type approval and certificate of compliance records shall be retained by the manufacturer and the inspection body for not less than 20 years.

**6.2.2.6 Approval system for periodic inspection and testing of pressure receptacles****6.2.2.6.1 Definition**

For the purposes of this section:

*Approval system* means a system for competent authority approval of a body performing periodic inspection and testing of pressure receptacles (hereinafter referred to as “periodic inspection and testing body”), including approval of that body’s quality system.

**6.2.2.6.2 General provisions***Competent authority*

**6.2.2.6.2.1** The competent authority shall establish an approval system for the purpose of ensuring that the periodic inspection and testing of pressure receptacles conform to the provisions of this Code. In instances where the competent authority that approves a body performing periodic inspection and testing of a pressure receptacle is not the competent authority of the country approving the manufacture of the pressure receptacle, the marks of the approval country of periodic inspection and testing shall be indicated in the pressure receptacle mark (see 6.2.2.7). The competent authority of the country of approval for the periodic inspection and testing shall supply, upon request, evidence demonstrating compliance with this approval system, including the records of the periodic inspection and testing, to its counterpart in a country of use. The competent authority of the country of approval may terminate the Approval Certificate referred to in 6.2.2.6.4.1, upon evidence demonstrating non-compliance with the approval system.

**6.2.2.6.2.2** The competent authority may delegate its functions in this approval system, in whole or in part.

**6.2.2.6.2.3** The competent authority shall ensure that a current list of approved periodic inspection and testing bodies and their identity marks is available.

*Periodic inspection and testing body*

**6.2.2.6.2.4** The periodic inspection and testing body shall be approved by the competent authority and shall:

- .1 have a staff with an organizational structure, capable, trained, competent, and skilled, to perform its technical functions satisfactorily;
- .2 have access to suitable and adequate facilities and equipment;
- .3 operate in an impartial manner and be free from any influence which could prevent it from doing so;
- .4 ensure commercial confidentiality;
- .5 maintain clear demarcation between actual periodic inspection and testing body functions and unrelated functions;
- .6 operate a documented quality system in accordance with 6.2.2.6.3;
- .7 apply for approval in accordance with 6.2.2.6.4;
- .8 ensure that the periodic inspections and tests are performed in accordance with 6.2.2.6.5; and
- .9 maintain an effective and appropriate report and record system in accordance with 6.2.2.6.6.

**6.2.2.6.3 Quality system and audit of the periodic inspection and testing body**

**6.2.2.6.3.1** *Quality system.* The quality system shall contain all the elements, requirements and provisions adopted by the periodic inspection and testing body. It shall be documented in a systematic and orderly manner in the form of written policies, procedures and instructions. The quality system shall include:

- .1 a description of the organizational structure and responsibilities;
- .2 the relevant inspection and test, quality control, quality assurance, and process operation instructions that will be used;
- .3 quality records, such as inspection reports, test data, calibration data and certificates;
- .4 management reviews to ensure the effective operation of the quality system arising from the audits performed in accordance with 6.2.2.6.3.2;
- .5 a process for control of documents and their revision;
- .6 a means for control of non-conforming pressure receptacles; and
- .7 training programmes and qualification procedures for relevant personnel.

**6.2.2.6.3.2** *Audit.* The periodic inspection and testing body and its quality system shall be audited in order to determine whether it meets the requirements of this Code to the satisfaction of the competent authority. An audit shall

## Chapter 6.2 – Provisions for the construction and testing of receptacles for gases

be conducted as part of the initial approval process (see 6.2.2.6.4.3). An audit may be required as part of the process to modify an approval (see 6.2.2.6.4.6). Periodic audits shall be conducted, to the satisfaction of the competent authority, to ensure that the periodic inspection and testing body continues to meet the provisions of this Code. The periodic inspection and testing body shall be notified of the results of any audit. The notification shall contain the conclusions of the audit and any corrective actions required.

**6.2.2.6.3.3** *Maintenance of the quality system.* The periodic inspection and testing body shall maintain the quality system as approved in order that it remains adequate and efficient. The periodic inspection and testing body shall notify the competent authority that approved the quality system of any intended changes, in accordance with the process for modification of an approval in 6.2.2.6.4.6.

**6.2.2.6.4** *Approval process for periodic inspection and testing bodies*

*Initial approval*

**6.2.2.6.4.1** A body desiring to perform periodic inspection and testing of pressure receptacles in accordance with a pressure receptacle standard and with this Code shall apply for, obtain, and retain an Approval Certificate issued by the competent authority. This written approval shall, on request, be submitted to the competent authority of a country of use.

**6.2.2.6.4.2** An application shall be made for each periodic inspection and testing body and shall include:

- .1 the name and address of the periodic inspection and testing body and, if the application is submitted by an authorized representative, its name and address;
- .2 the address of each facility performing periodic inspection and testing;
- .3 the name and title of the person(s) responsible for the quality system;
- .4 the designation of the pressure receptacles, the periodic inspection and test methods, and the relevant pressure receptacle standards met by the quality system;
- .5 documentation on each facility, the equipment, and the quality system as specified under 6.2.2.6.3.1;
- .6 the qualifications and training records of the periodic inspection and test personnel; and
- .7 details of any refusal of approval of a similar application by any other competent authority.

**6.2.2.6.4.3** The competent authority shall:

- .1 examine the documentation to verify that the procedures are in accordance with the requirements of the relevant pressure receptacle standards and of this Code; and
- .2 conduct an audit in accordance with 6.2.2.6.3.2 to verify that the inspections and tests are carried out as required by the relevant pressure receptacle standards and by this Code, to the satisfaction of the competent authority.

**6.2.2.6.4.4** After the audit has been carried out with satisfactory results and all applicable requirements of 6.2.2.6.4 have been satisfied, an Approval Certificate shall be issued. It shall include the name of the periodic inspection and testing body, the registered mark, the address of each facility, and the necessary data for identification of its approved activities (e.g. designation of pressure receptacles, periodic inspection and test method and pressure receptacle standards).

**6.2.2.6.4.5** If the periodic inspection and testing body is denied approval, the competent authority shall provide written detailed reasons for such denial.

*Modifications to periodic inspection and testing body approvals*

**6.2.2.6.4.6** Following approval, the periodic inspection and testing body shall notify the issuing competent authority of any modifications to the information submitted under 6.2.2.6.4.2 relating to the initial approval. The modifications shall be evaluated in order to determine whether the requirements of the relevant pressure receptacle standards and of this Code will be satisfied. An audit in accordance with 6.2.2.6.3.2 may be required. The competent authority shall accept or reject these modifications in writing, and an amended Approval Certificate shall be issued as necessary.

**6.2.2.6.4.7** Upon request, the competent authority shall communicate to any other competent authority, information concerning initial approvals, modifications of approvals, and withdrawn approvals.

**6.2.2.6.5** *Periodic inspection and test and certification*

The application of the periodic inspection and test marks to a pressure receptacle shall be considered a declaration that the pressure receptacle complies with the applicable pressure receptacle standards and with the provisions of this Code. The periodic inspection and testing body shall affix the periodic inspection and test marks, including its registered mark, to each approved pressure receptacle (see 6.2.2.7.7). A record certifying that a pressure receptacle has passed the periodic inspection and test shall be issued by the periodic inspection and testing body, before the pressure receptacle is filled.

**Part 6 – Construction and testing of packagings, IBCs, etc.****6.2.2.6.6 Records**

The periodic inspection and testing body shall retain records of pressure receptacle periodic inspection and tests (both passed and failed), including the location of the test facility, for not less than 15 years. The owner of the pressure receptacle shall retain an identical record until the next periodic inspection and test unless the pressure receptacle is permanently removed from service.

**6.2.2.7 Marking of refillable UN pressure receptacles**

**Note:** Marking requirements for UN metal hydride storage systems are given in 6.2.2.9, marking requirements for UN bundles of cylinders are given in 6.2.2.10 and marking requirements for closures are given in 6.2.2.11.

**6.2.2.7.1** Refillable UN pressure receptacle shells and closed cryogenic receptacles shall be marked clearly and legibly with certification, operational and manufacturing marks. These marks shall be permanently affixed (e.g. stamped, engraved, or etched). The marks shall be on the shoulder, top end or neck of the pressure receptacle shell or on a permanently affixed component of the pressure receptacle (e.g. welded collar or corrosion-resistant plate welded on the outer jacket of a closed cryogenic receptacle). Except for the UN packaging symbol, the minimum size of the marks shall be 5 mm for pressure receptacles with a diameter greater than or equal to 140 mm and 2.5 mm for pressure receptacles with a diameter less than 140 mm. The minimum size of the UN packaging symbol shall be 10 mm for pressure receptacles with a diameter greater than or equal to 140 mm and 5 mm for pressure receptacles with a diameter less than 140 mm.

**6.2.2.7.2** The following certification marks shall be applied:

(a) The UN packaging symbol:



This symbol shall not be used for any purpose other than certifying that a packaging, a flexible bulk container, a portable tank or a MEGC complies with the relevant requirements in chapters 6.1, 6.2, 6.3, 6.5, 6.6, 6.7 or 6.9.

(b) The technical standard (e.g. ISO 9809-1) used for design, construction and testing.

**Note:** For acetylene cylinders, the standard ISO 3807 shall also be marked.

(c) The character(s) identifying the country of approval as indicated by the distinguishing sign used on vehicles in international road traffic.\*

**Note:** For the purpose of this mark the country of approval means the country of the competent authority that authorized the initial inspection and test of the individual receptacle at the time of manufacture.

(d) The identity mark or stamp of the inspection body that is registered with the competent authority of the country authorizing the marking.

(e) The date of the initial inspection, the year (four digits) followed by the month (two digits) separated by a slash (i.e. “/”).

**Note:** When an acetylene cylinder is conformity assessed in accordance with 6.2.1.4.4.2 and the inspection bodies for the cylinder shell and the acetylene cylinder are different, their respective marks (d) are required. Only the initial inspection date (e) of the completed acetylene cylinder is required. If the country of approval of the inspection body responsible for the initial inspection and test is different, a second mark (c) shall be applied.

**6.2.2.7.3** The following operational marks shall be applied:

(f) The test pressure in bar, preceded by the letters “PH” and followed by the letters “BAR”.

(g) The mass of the empty pressure receptacle including all permanently attached integral parts (e.g. neck ring, foot ring, etc.) in kilograms, followed by the letters “KG”. This mass shall not include the mass of closure(s), valve protection cap or valve guard, any coating, or porous mass for acetylene. The mass shall be expressed to three significant figures rounded up to the last digit. For cylinders of less than 1 kg, the mass shall be expressed to two significant figures rounded up to the last digit. In the case of pressure receptacles for UN 1001 acetylene, dissolved and UN 3374 acetylene, solvent free, at least one decimal shall be shown after the decimal point and two digits for pressure receptacles of less than 1 kg.

(h) The minimum guaranteed wall thickness of the pressure receptacle in millimetres followed by the letters “MM”. This mark is not required for pressure receptacles with a water capacity less than or equal to 1 L or for composite cylinders or for closed cryogenic receptacles.

\* Distinguishing sign of the State of registration used on motor vehicles and trailers in international road traffic, e.g. in accordance with the Geneva Convention on Road Traffic of 1949 or the Vienna Convention on Road Traffic of 1968.

## Chapter 6.2 – Provisions for the construction and testing of receptacles for gases

- (i) In the case of pressure receptacles for compressed gases, UN 1001 acetylene, dissolved, and UN 3374 acetylene, solvent free, the working pressure in bar, preceded by the letters "PW". In the case of closed cryogenic receptacles, the maximum allowable working pressure preceded by the letters "MAWP".  
**Note:** When a cylinder shell is intended for use as an acetylene cylinder (including the porous material), the working pressure mark is not required until the acetylene cylinder is completed.
  - (j) In the case of pressure receptacles for liquefied gases, refrigerated liquefied gases and dissolved gases, the water capacity in litres expressed to three significant figures rounded down to the last digit, followed by the letter "L". If the value of the minimum or nominal water capacity is an integer, the digits after the decimal point may be neglected.
  - (k) In the case of cylinders for UN 1001 acetylene, dissolved:
    - (i) the tare in kilograms consisting of the total of the mass of the empty cylinder shell, the service equipment (including porous material) not removed during filling, any coating, the solvent and the saturation gas expressed to three significant figures rounded down to the last digit followed by the letters "KG". At least one decimal shall be shown after the decimal point. For pressure receptacles of less than 1 kg, the mass shall be expressed to two significant figures rounded down to the last digit;
    - (ii) the identity of the porous material (e.g. name or trademark); and
    - (iii) the total mass of the filled acetylene cylinder in kilograms followed by the letters "KG".
  - (l) In the case of cylinders for UN 3374 acetylene, solvent free:
    - (i) the tare in kilograms consisting of the total of the mass of the empty cylinder shell, the service equipment (including porous material) not removed during filling and any coating expressed to three significant figures rounded down to the last digit followed by the letters "KG". At least one decimal shall be shown after the decimal point. For pressure receptacles of less than 1 kg, the mass shall be expressed to two significant figures rounded down to the last digit;
    - △ (ii) the identity of the porous material (e.g.: name or trademark); and
    - (iii) the total mass of the filled acetylene cylinder in kilograms followed by the letters "KG".
- **Note:** Acetylene cylinders constructed in accordance with the IMDG Code Amendment 40-20 which are not marked in accordance with 6.2.2.7.3 (k) or (l) applicable in the the IMDG Code Amendment 41-22, may continue to be used until the next periodic inspection and test two years after the coming into force of the IMDG Code Amendment 42-24 where they have to be marked according to the IMDG Code Amendment 42-24 or be taken out of operation.

## 6.2.2.7.4 The following manufacturing marks shall be applied:

- (m) Identification of the cylinder thread (e.g. 25E). This mark is not required for closed cryogenic receptacles.  
**Note:** Information on marks that may be used for identifying threads for cylinders is given in ISO/TR 11364, *Gas cylinders – Compilation of national and international valve stem/gas cylinder neck threads and their identification and marking system*.
- (n) The manufacturer's mark registered by the competent authority. When the country of manufacture is not the same as the country of approval, then the manufacturer's mark shall be preceded by the character(s) identifying the country of manufacture as indicated by the distinguishing sign used on vehicles in international road traffic.\* The country mark and the manufacturer's mark shall be separated by a space or slash.  
**Note:** For acetylene cylinders, if the manufacturer of the acetylene cylinder and the manufacturer of the cylinder shell are different, only the mark of the manufacturer of the completed acetylene cylinder is required.
- (o) The serial number assigned by the manufacturer.
- △ (p) In the case of steel pressure receptacles and composite pressure receptacles with steel liner intended for the transport of gases with a risk of hydrogen embrittlement, the letter "H" showing compatibility of the steel (see ISO 11114-1:2020).
- (q) For composite cylinders and tubes having a limited design life, the letters "FINAL" followed by the design life shown as the year (four digits) followed by the month (two digits) separated by a slash (i.e. "/").
- (r) For composite cylinders and tubes having a limited design life greater than 15 years and for composite cylinders and tubes having non-limited design life, the letters "SERVICE" followed by the date 15 years from the date of manufacture (initial inspection) shown as the year (four digits) followed by the month (two digits) separated by a slash (i.e. "/").  
**Note:** Once the initial design type has passed the service life test programme requirements in accordance with 6.2.2.1.1 Note 2 or 6.2.2.1.2 Note 2, future production no longer requires this initial service life mark.

\* Distinguishing sign of the State of registration used on motor vehicles and trailers in international road traffic, e.g. in accordance with the Geneva Convention on Road Traffic of 1949 or the Vienna Convention on Road Traffic of 1968.



Part 6 – Construction and testing of packagings, IBCs, etc.

The initial service life mark shall be made unreadable on cylinders and tubes of a design type that has met the service life test programme requirements.

6.2.2.7.5 The above marks shall be placed in three groups.

- Manufacturing marks shall be the top grouping and shall appear consecutively in the sequence given in 6.2.2.7.4 except for the marks described in 6.2.2.7.4 (q) and (r) which shall be adjacent to the periodic inspection and test marks of 6.2.2.7.7.
- The operational marks in 6.2.2.7.3 shall be the middle grouping and the test pressure (f) shall be immediately preceded by the working pressure (i) when the latter is required.
- Certification marks shall be the bottom grouping and shall appear in the sequence given in 6.2.2.7.2.

The following is an example of marking a cylinder.

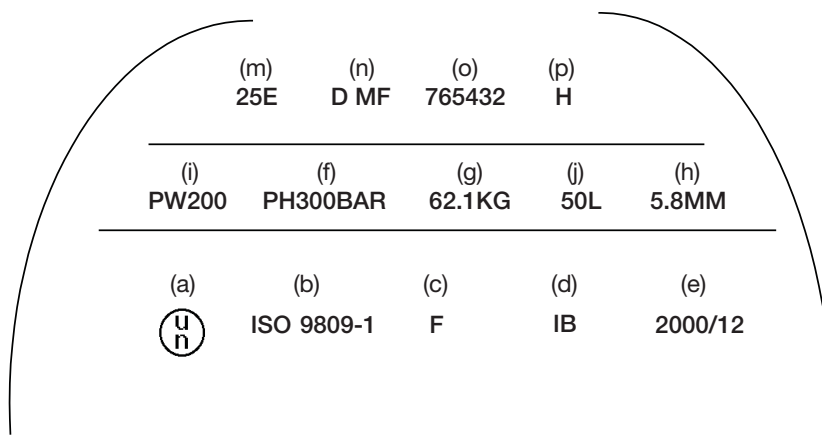

6.2.2.7.6 Other marks are allowed in areas other than the side wall, provided they are made in low-stress areas and are not of a size and depth that will create harmful stress concentrations. In the case of closed cryogenic receptacles, such marks may be on a separate plate attached to the outer jacket. Such marks shall not conflict with required marks.

6.2.2.7.7 In addition to the preceding marks, each refillable pressure receptacle that meets the periodic and test requirements of 6.2.2.4 shall be marked in sequence as follows:

- (a) the character(s) identifying the country authorizing the body performing the periodic inspection and test, as indicated by the distinguishing sign used on vehicles in international road traffic.\* This mark is not required if this body is approved by the competent authority of the country approving manufacture;
- (b) the registered mark of the body authorized by the competent authority for performing periodic inspection and test;
- (c) the date of the periodic inspection and test, the year (two digits) followed by the month (two digits) separated by a slash (i.e. “/”). Four digits may be used to indicate the year.

6.2.2.7.8 The marks in accordance with 6.2.2.7.7 may be engraved on a metallic ring affixed to the cylinder or pressure drum when the valve is installed, and which is removable only by disconnecting the valve from the cylinder or pressure drum.

6.2.2.8 Marking of non-refillable UN cylinders

6.2.2.8.1 Non-refillable UN cylinders shall be marked clearly and legibly with certification and gas or cylinder specific marks. These marks shall be permanently affixed (e.g. stencilled, stamped, engraved, or etched) on the cylinder. Except when stencilled, the marks shall be on the shoulder, top end or neck of the cylinder shell or on a permanently affixed component of the cylinder (e.g. welded collar). Except for the “UN” mark and the “DO NOT REFILL” mark, the minimum size of the marks shall be 5 mm for cylinders with a diameter greater than or equal to 140 mm and 2.5 mm for cylinders with a diameter less than 140 mm. The minimum size of the “UN” mark shall be 10 mm for cylinders with a diameter greater than or equal to 140 mm and 5 mm for cylinders with a diameter less than 140 mm. The minimum size of the “DO NOT REFILL” mark shall be 5 mm.

\* Distinguishing sign of the State of registration used on motor vehicles and trailers in international road traffic, e.g. in accordance with the Geneva Convention on Road Traffic of 1949 or the Vienna Convention on Road Traffic of 1968.

## Chapter 6.2 – Provisions for the construction and testing of receptacles for gases

6.2.2.8.2 The marks listed in 6.2.2.7.2 to 6.2.2.7.4 shall be applied with the exception of (g), (h) and (m). The serial number (o) may be replaced by the batch number. In addition, the words “DO NOT REFILL” in letters of at least 5 mm in height are required.

6.2.2.8.3 The requirements of 6.2.2.7.5 shall apply.

**Note:** Non-refillable cylinders may, on account of their size, substitute a label for these permanent marks.

6.2.2.8.4 Other marks are allowed provided they are made in low-stress areas other than the side wall and are not of a size and depth that will create harmful stress concentrations. Such marks shall not conflict with required marks.

### 6.2.2.9 Marking of UN metal hydride storage systems

6.2.2.9.1 UN metal hydride storage systems shall be marked clearly and legibly with the marks listed below. These marks shall be permanently affixed (e.g. stamped, engraved, or etched) on the metal hydride storage system. The marks shall be on the shoulder, top end or neck of the metal hydride storage system or on a permanently affixed component of the metal hydride storage system. Except for the United Nations packaging symbol, the minimum size of the marks shall be 5 mm for metal hydride storage systems with a smallest overall dimension greater than or equal to 140 mm and 2.5 mm for metal hydride storage systems with a smallest overall dimension less than 140 mm. The minimum size of the United Nations packaging symbol shall be 10 mm for metal hydride storage systems with a smallest overall dimension greater than or equal to 140 mm and 5 mm for metal hydride storage systems with a smallest overall dimension less than 140 mm.

6.2.2.9.2 The following marks shall be applied:

(a) The United Nations packaging symbol:



This symbol shall not be used for any purpose other than certifying that a packaging, a flexible bulk container, a portable tank or a MEGC complies with the relevant requirements in chapters 6.1, 6.2, 6.3, 6.5, 6.6, 6.7 or 6.9.

(b) “ISO 16111” (the technical standard used for design, manufacture and testing).

(c) The character(s) identifying the country of approval as indicated by the distinguishing sign used on vehicles in international road traffic.\*

**Note:** For the purpose of this mark the country of approval means the country of the competent authority that authorized the initial inspection and test of the individual system at the time of manufacture.

(d) The identity mark or stamp of the inspection body that is registered with the competent authority of the country authorizing the marking.

(e) The date of the initial inspection, the year (four digits) followed by the month (two digits) separated by a slash (i.e. “/”).

(f) The test pressure of the receptacle in bar, preceded by the letters “PH” and followed by the letters “BAR”.

(g) The rated charging pressure of the metal hydride storage system in bar, preceded by the letters “RCP” and followed by the letters “BAR”.

(h) The manufacturer’s mark registered by the competent authority. When the country of manufacture is not the same as the country of approval, then the manufacturer’s mark shall be preceded by the character(s) identifying the country of manufacture as indicated by the distinguishing sign used on vehicles in international road traffic.\* The country mark and the manufacturer’s mark shall be separated by a space or slash.

(i) The serial number assigned by the manufacturer.

△ (j) In the case of steel receptacles and composite receptacles with steel liner, the letter “H” showing compatibility of the steel (see ISO 11114-1:2020).

(k) In the case of metal hydride storage systems having limited life, the date of expiry, denoted by the letters “FINAL” followed by the year (four digits) followed by the month (two digits) separated by a slash (i.e. “/”).

The certification marks specified in (a) to (e) above shall appear consecutively in the sequence given. The test pressure (f) shall be immediately preceded by the rated charging pressure (g). The manufacturing marks specified in (h) to (k) above shall appear consecutively in the sequence given.

6.2.2.9.3 Other marks are allowed in areas other than the side wall, provided they are made in low stress areas and are not of a size and depth that will create harmful stress concentrations. Such marks shall not conflict with required marks.



**Part 6 – Construction and testing of packagings, IBCs, etc.**

- 6.2.2.9.4** In addition to the preceding marks, each metal hydride storage system that meets the periodic and test requirements of 6.2.2.4 shall be marked indicating:
- (a) The character(s) identifying the country authorizing the body performing the periodic inspection and test, as indicated by the distinguishing sign used on vehicles in international road traffic.\* This mark is not required if this body is approved by the competent authority of the country approving manufacture;
  - (b) The registered mark of the body authorized by the competent authority for performing periodic inspection and test;
  - (c) The date of the periodic inspection and test, the year (two digits) followed by the month (two digits) separated by a slash (i.e. “/”). Four digits may be used to indicate the year.

The above marks shall appear consecutively in the sequence given.

**6.2.2.10 Marking of UN bundles of cylinders**

**6.2.2.10.1** Individual cylinder shells in a bundle of cylinders shall be marked in accordance with 6.2.2.7. Individual closures in a bundle of cylinders shall be marked in accordance with 6.2.2.11.

**6.2.2.10.2** Refillable UN bundles of cylinders shall be marked clearly and legibly with certification, operational, and manufacturing marks. These marks shall be permanently affixed (e.g. stamped, engraved, or etched) on a plate permanently attached to the frame of the bundle of cylinders. Except for the UN packaging symbol, the minimum size of the marks shall be 5 mm. The minimum size of the UN packaging symbol shall be 10 mm.

**6.2.2.10.3** The following marks shall be applied:

- (a) The certification marks specified in 6.2.2.7.2 (a), (b), (c), (d) and (e).
- (b) The operational marks specified in 6.2.2.7.3 (f), (i), (j) and the total of the mass of the frame of the bundle and all permanently attached parts (cylinder shells and service equipment). Bundles intended for the carriage of UN 1001 acetylene, dissolved and UN 3374 acetylene, solvent free shall bear the tare as specified in clause B.4.2 of ISO 10961:2010.
- (c) The manufacturing marks specified in 6.2.2.7.4 (n), (o) and, where applicable, (p).

**6.2.2.10.4** The marks shall be placed in three groups:

- (a) The manufacturing marks shall be the top grouping and shall appear consecutively in the sequence given in 6.2.2.10.3 (c).
- (b) The operational marks in 6.2.2.10.3 (b) shall be the middle grouping and the operational mark specified in 6.2.2.7.3 (f) shall be immediately preceded by the operational mark specified in 6.2.2.7.3 (i) when the latter is required.
- (c) Certification marks shall be the bottom grouping and shall appear in the sequence given in 6.2.2.10.3 (a).

**6.2.2.11 Marking of closures for refillable UN pressure receptacles**

For closures the following permanent marks shall be applied clearly and legibly (e.g. stamped, engraved or etched):

- .1 manufacturer’s identification mark;
- .2 design standard or design standard designation;
- .3 date of manufacture (year and month or year and week); and
- .4 the identity mark of the inspection body responsible for the initial inspection and test, if applicable.

The valve test pressure shall be marked when it is less than the test pressure which is indicated by the rating of the valve filling connection.

- **Note:** Closures of refillable pressure receptacles manufactured before 1 January 2027 in accordance with the requirements applicable in the IMDG Code Amendment 40-20 which are not marked in accordance with the requirements of 6.2.2.11 applicable in the IMDG Code Amendment 41-22 may continue to be used.

**6.2.3 Provisions for non-UN pressure receptacles**

**6.2.3.1** Pressure receptacles not designed, constructed, inspected, tested and approved according to 6.2.2 shall be designed, constructed, inspected, tested and approved in accordance with a technical code recognized by the competent authority and the general provisions of 6.2.1.

\* Distinguishing sign of the State of registration used on motor vehicles and trailers in international road traffic, e.g. in accordance with the Geneva Convention on Road Traffic of 1949 or the Vienna Convention on Road Traffic of 1968.

## Chapter 6.2 – Provisions for the construction and testing of receptacles for gases

- 6.2.3.2 Pressure receptacles designed, constructed, inspected, tested and approved under the provisions of this section shall not be marked with the UN packaging symbol.
- 6.2.3.3 For metallic cylinders, tubes, pressure drums, bundles of cylinders and salvage pressure receptacles, the construction shall be such that the minimum burst ratio (burst pressure divided by test pressure) is:
- 1.50 for refillable pressure receptacles;
  - 2.00 for non-refillable pressure receptacles.
- 6.2.3.4 Marking shall be in accordance with the requirements of the competent authority of the country of use.
- 6.2.3.5 **Salvage pressure receptacles**
- Note:** These provisions of 6.2.3.5 for salvage pressure receptacles may be applied for new salvage pressure receptacles as from 1 January 2013, unless otherwise authorized, and shall be applied for all new salvage pressure receptacles as from 1 January 2014. Salvage pressure receptacles approved in accordance with national regulations may be used with the approval of the competent authorities of the countries of use.
- 6.2.3.5.1 To permit the safe handling and disposal of the pressure receptacles transported within the salvage pressure receptacle, the design may include equipment not otherwise used for cylinders or pressure drums such as flat heads, quick opening devices and openings in the cylindrical part.
- 6.2.3.5.2 Instructions on the safe handling and use of the salvage pressure receptacle shall be clearly shown in the documentation for the application to the competent authority and shall form part of the approval certificate. In the approval certificate, the pressure receptacles authorized to be transported in a salvage pressure receptacle shall be indicated. A list of the materials of construction of all parts likely to be in contact with the dangerous goods shall also be included.
- 6.2.3.5.3 A copy of the approval certificate shall be delivered by the manufacturer to the owner of a salvage pressure receptacle.
- 6.2.3.5.4 The marking of salvage pressure receptacles according to 6.2.3 shall be determined by the competent authority in taking into account suitable marking provisions of 6.2.2.7 as appropriate. The marking shall include the water capacity and test pressure of the salvage pressure receptacle.
- 6.2.4 **Provisions for aerosol dispensers, small receptacles containing gas (gas cartridges) and fuel cell cartridges containing liquefied flammable gas**
- 6.2.4.1 The internal pressure of aerosol dispensers at 50°C shall not exceed 1.2 MPa (12 bar) when using flammable liquefied gases, 1.32 MPa (13.2 bar) when using non-flammable liquefied gases, and 1.5 MPa (15 bar) when using non-flammable compressed or dissolved gases. In case of a mixture of several gases, the stricter limit shall apply.
- 6.2.4.2 Each filled aerosol dispenser or gas cartridge or fuel cell cartridge shall be subjected to a test in a hot water bath in accordance with 6.2.4.2.1 or an approved water bath alternative in accordance with 6.2.4.2.2.
- 6.2.4.2.1 **Hot water bath test**
- 6.2.4.2.1.1 The temperature of the water bath and the duration of the test shall be such that the internal pressure reaches that which would be reached at 55°C (50°C if the liquid phase does not exceed 95% of the capacity of the aerosol dispenser, gas cartridge or fuel cell cartridge at 50°C). If the contents are sensitive to heat or if the aerosol dispensers, gas cartridges or fuel cell cartridges are made of plastics material which softens at this test temperature, the temperature of the bath shall be set at between 20°C and 30°C but, in addition, one aerosol dispenser, gas cartridge or fuel cell cartridge in 2,000 shall be tested at the higher temperature.
- 6.2.4.2.1.2 No leakage or permanent deformation of an aerosol dispenser, receptacle or fuel cell cartridge may occur, except that a plastic aerosol dispenser, gas cartridge or fuel cell cartridge may be deformed through softening provided that it does not leak.
- 6.2.4.2.2 **Alternative methods**
- With the approval of the competent authority, alternative methods which provide an equivalent level of safety may be used provided that the requirements of 6.2.4.2.2.1 and, as appropriate, 6.2.4.2.2.2 or 6.2.4.2.2.3 are met.
- 6.2.4.2.2.1 **Quality system**
- Aerosol dispenser, gas cartridge or fuel cell cartridge fillers and component manufacturers shall have a quality system. The quality system shall implement procedures to ensure that all aerosol dispensers, gas cartridges or fuel cell cartridges that leak or that are deformed are rejected and not offered for transport.

**Part 6 – Construction and testing of packagings, IBCs, etc.**

The quality system shall include:

- (a) a description of the organizational structure and responsibilities;
- (b) the relevant inspection and test, quality control, quality assurance, and process operation instructions that will be used;
- (c) quality records, such as inspection reports, test data, calibration data and certificates;
- (d) management reviews to ensure the effective operation of the quality system;
- (e) a process for control of documents and their revision;
- (f) a means for control of non-conforming aerosol dispensers, gas cartridges or fuel cell cartridges;
- (g) training programmes and qualification procedures for relevant personnel; and
- (h) procedures to ensure that there is no damage to the final product.

An initial audit and periodic audits shall be conducted to the satisfaction of the competent authority. These audits shall ensure the approved system is and remains adequate and efficient. Any proposed changes to the approved system shall be notified to the competent authority in advance.

**6.2.4.2.2.2 Aerosol dispensers****6.2.4.2.2.2.1 Pressure and leak testing of aerosol dispensers before filling**

Each empty aerosol dispenser shall be subjected to a pressure equal to or in excess of the maximum expected in the filled aerosol dispensers at 55°C (50°C if the liquid phase does not exceed 95% of the capacity of the receptacle at 50°C). This shall be at least two-thirds of the design pressure of the aerosol dispenser. If any aerosol dispenser shows evidence of leakage at a rate equal to or greater than  $3.3 \times 10^{-2}$  mbar·L·s<sup>-1</sup> at the test pressure, distortion or other defect, it shall be rejected.

**6.2.4.2.2.2.2 Testing of the aerosol dispensers after filling**

Prior to filling, the filler shall ensure that the crimping equipment is set appropriately and the specified propellant is used.

Each filled aerosol dispenser shall be weighed and leak tested. The leak detection equipment shall be sufficiently sensitive to detect at least a leak rate of  $2.0 \times 10^{-3}$  mbar·L·s<sup>-1</sup> at 20°C.

Any filled aerosol dispenser which shows evidence of leakage, deformation or excessive mass shall be rejected.

**6.2.4.2.2.3 Gas cartridges and fuel cell cartridges****6.2.4.2.2.3.1 Pressure testing of gas cartridges and fuel cell cartridges**

Each gas cartridge or fuel cell cartridge shall be subjected to a test pressure equal to or in excess of the maximum expected in the filled receptacle at 55°C (50°C if the liquid phase does not exceed 95% of the capacity of the receptacle at 50°C). This test pressure shall be that specified for the gas cartridge or fuel cell cartridge and shall not be less than two thirds the design pressure of the gas cartridge or fuel cell cartridge. If any gas cartridge or fuel cell cartridge shows evidence of leakage at a rate equal to or greater than  $3.3 \times 10^{-2}$  mbar·L·s<sup>-1</sup> at the test pressure or distortion or any other defect, it shall be rejected.

**6.2.4.2.2.3.2 Leak testing gas cartridges and fuel cell cartridges**

Prior to filling and sealing, the filler shall ensure that the closures (if any), and the associated sealing equipment are closed appropriately and the specified gas is used.

Each filled gas cartridge or fuel cell cartridge shall be checked for the correct mass of gas and shall be leak tested. The leak detection equipment shall be sufficiently sensitive to detect at least a leak rate of  $2.0 \times 10^{-3}$  mbar·L·s<sup>-1</sup> at 20°C.

Any gas cartridge or fuel cell cartridge that has gas masses not in conformity with the declared mass limits or shows evidence of leakage or deformation, shall be rejected.

**6.2.4.2.3** With the approval of the competent authority, aerosols and receptacles, small, are not subject to 6.2.4.2.1 and 6.2.4.2.2, if they are required to be sterile but may be adversely affected by water bath testing, provided:

- (a) They contain a non-flammable gas and either
  - (i) contain other substances that are constituent parts of pharmaceutical products for medical, veterinary or similar purposes;
  - (ii) contain other substances used in the production process for pharmaceutical products; or
  - (iii) are used in medical, veterinary or similar applications;

Chapter 6.2 – Provisions for the construction and testing of receptacles for gases

---

- (b) An equivalent level of safety is achieved by the manufacturer's use of alternative methods for leak detection and pressure resistance, such as helium detection and water bathing a statistical sample of at least 1 in 2,000 from each production batch; and
- (c) For pharmaceutical products according to (a)(i) and (iii) above, they are manufactured under the authority of a national health administration. If required by the competent authority, the principles of Good Manufacturing Practice (GMP) established by the World Health Organization (WHO)\* shall be followed.

---

\* Refer to WHO publication: *Quality assurance of pharmaceuticals. A compendium of guidelines and related materials. Volume 2: Good manufacturing practices and inspection.*

## Chapter 6.3

### *Provisions for the construction and testing of packagings for class 6.2 infectious substances of category A (UN 2814 and UN 2900)*

#### 6.3.1 General

6.3.1.1 The provisions of this chapter apply to packagings intended for the transport of infectious substances of category A, UN 2814 and UN 2900.

#### 6.3.2 Provisions for packagings

6.3.2.1 The provisions for packagings in this section are based on packagings, as specified in 6.1.4, currently used. In order to take into account progress in science and technology, there is no objection to the use of packagings having specifications different from those in this chapter provided that they are equally effective, acceptable to the competent authority and able to successfully fulfil the provisions described in 6.3.5. Methods of testing other than those described in the provisions of this Code are acceptable provided they are equivalent.

6.3.2.2 Packagings shall be manufactured and tested under a quality assurance programme which satisfies the competent authority in order to ensure that each packaging meets the provisions of this chapter.

**Note:** ISO 16106:2020, *Transport packages for dangerous goods – Dangerous goods packagings, intermediate bulk containers (IBCs) and large packagings – Guidelines for the application of ISO 9001*, provides acceptable guidance on procedures which may be followed.

6.3.2.3 Manufacturers and subsequent distributors of packagings shall provide information regarding procedures to be followed and a description of the types and dimensions of closures (including required gaskets) and any other components needed to ensure that packages as presented for transport are capable of passing the applicable performance tests of this chapter.

#### 6.3.3 Code for designating types of packagings

6.3.3.1 The codes for designating types of packagings are set out in 6.1.2.7.

6.3.3.2 The letters “U” or “W” may follow the packaging code. The letter “U” signifies a special packaging conforming to the provisions of 6.3.5.1.6. The letter “W” signifies that the packaging, although of the same type as indicated by the code, is manufactured to a specification different from that in 6.1.4 and is considered equivalent under the provisions of 6.3.2.1.

#### 6.3.4 Marking

**Note 1:** The marks indicate that the packaging which bears them correspond to a successfully tested design type and that it complies with the provisions of this chapter which are related to the manufacture, but not to the use, of the packaging.

**Note 2:** The marks are intended to be of assistance to packaging manufacturers, reconditioners, packaging users, carriers and regulatory authorities.

**Note 3:** The marks do not always provide full details of the test levels, etc., and these may need to be taken further into account, e.g. by reference to a test certificate, to test reports or to a register of successfully tested packagings.

6.3.4.1 Each packaging intended for use according to the provisions of this Code shall bear marks which are durable, legible and placed in a location and of such a size relative to the packaging as to be readily visible. For packages with a gross mass of more than 30 kg, the marks or a duplicate thereof shall appear on the top or on a side of the packaging. Letters, numerals and symbols shall be at least 12 mm high, except for packagings of 30 L capacity

or less or of 30 kg maximum net mass, when they shall be at least 6 mm in height and except for packagings of 5 L capacity or less or of 5 kg maximum net mass when they shall be of an appropriate size.

6.3.4.2 A packaging that meets the provisions of this section and of 6.3.5 shall be marked with:

(a) the United Nations packaging symbol: 

This symbol shall not be used for any purpose other than certifying that a packaging, a flexible bulk container, a portable tank or a MEGC complies with the relevant requirements in chapters 6.1, 6.2, 6.3, 6.5, 6.6, 6.7 or 6.9;

- (b) the code designating the type of packaging according to the provisions of 6.1.2;
- (c) the text “CLASS 6.2”;
- (d) the last two digits of the year of manufacture of the packaging;
- (e) the State authorizing the allocation of the mark, the distinguishing sign used on vehicles in international road traffic\*;
- (f) the name of the manufacturer or other identification of the packaging specified by the competent authority; and
- (g) for packagings meeting the provisions of 6.3.5.1.6, the letter “U” shall be inserted immediately following the mark required in (b) above.

6.3.4.3 Marks shall be applied in the sequence shown in 6.3.4.2 (a) to (g); each mark required in these subparagraphs shall be clearly separated, e.g. by a slash or space, so as to be easily identifiable. For examples, see 6.3.4.4.

Any additional markings authorized by a competent authority shall still enable the marks required in 6.3.4.1 to be correctly identified.

6.3.4.4 Example of marking



4G/CLASS 6.2/06 as in 6.3.4.2 (a), (b), (c) and (d)  
S/SP-9989-ERIKSSON as in 6.3.4.2 (e) and (f)

## 6.3.5 Test provisions for packagings

### 6.3.5.1 Performance and frequency of tests

6.3.5.1.1 The design type of each packaging shall be tested as provided in this section in accordance with procedures established by the competent authority.

6.3.5.1.2 Each packaging design type shall successfully pass the tests prescribed in this chapter before being used. A packaging design type is defined by the design, size, material and thickness, manner of construction and packing, but may include various surface treatments. It also includes packagings which differ from the design type only in their lesser design height.

6.3.5.1.3 Tests shall be repeated on production samples at intervals established by the competent authority.

6.3.5.1.4 Tests shall also be repeated after each modification which alters the design, material or manner of construction of a packaging.

6.3.5.1.5 The competent authority may permit the selective testing of packagings that differ only in minor respects from a tested type, such as smaller sizes or lower net mass of primary receptacles; and packagings such as drums and boxes which are produced with small reductions in external dimension(s).

6.3.5.1.6 Primary receptacles of any type may be assembled within a secondary packaging and transported without testing in the rigid outer packaging under the following conditions:

- .1 the rigid outer packaging shall have been successfully tested in accordance with 6.3.5.2.2 with fragile (such as glass) primary receptacles;
- .2 the total combined gross mass of primary receptacles shall not exceed one half of the gross mass of primary receptacles used for the drop test in .1 above;
- .3 the thickness of cushioning between primary receptacles and between primary receptacles and the outside of the secondary packaging shall not be reduced below the corresponding thicknesses in the

\* Distinguishing sign of the State of registration used on motor vehicles and trailers in international road traffic, e.g. in accordance with the Geneva Convention on Road Traffic of 1949 or the Vienna Convention on Road Traffic of 1968.

Part 6 – Construction and testing of packagings, IBCs, etc.

originally tested packaging; and if a single primary receptacle was used in the original test, the thickness of cushioning between primary receptacles shall not be less than the thickness of cushioning between the outside of the secondary packaging and the primary receptacle in the original test. When either fewer or smaller primary receptacles are used (as compared to the primary receptacles used in the drop test), sufficient additional cushioning material shall be used to take up the void spaces;

- .4 the rigid outer packaging shall have successfully passed the stacking test in 6.1.5.6 while empty. The total mass of identical packages shall be based on the combined mass of packagings used in the drop test in .1 above;
- .5 for primary receptacles containing liquids, an adequate quantity of absorbent material to absorb the entire liquid content of the primary receptacles shall be present;
- .6 if the rigid outer packaging is intended to contain primary receptacles for liquids and is not leakproof, or is intended to contain primary receptacles for solids and is not sift-proof, a means of containing any liquid or solid contents in the event of leakage shall be provided in the form of a leakproof liner, plastics bag or other equally effective means of containment; and
- .7 in addition to the marks prescribed in 6.3.4.2 (a) to (f), packagings shall be marked in accordance with 6.3.4.2(g).

6.3.5.1.7 The competent authority may at any time require proof, by tests in accordance with this section, that serially produced packagings meet the provisions of the design type tests.

6.3.5.1.8 Provided the validity of the test results is not affected and with the approval of the competent authority, several tests may be made on one sample.

6.3.5.2 Preparation of packagings for testing

6.3.5.2.1 Samples of each packaging shall be prepared as for transport except that a liquid or solid infectious substance shall be replaced by water or, where conditioning at –18°C is specified, by water containing antifreeze. Each primary receptacle shall be filled to not less than 98% of its capacity.

**Note:** The term “water” includes water/antifreeze solution with a minimum specific gravity of 0.95 for testing at –18°C.

6.3.5.2.2 Tests and number of samples required

Tests required for packaging types

| Type of packaging <sup>a</sup>    | Tests required     |       |                            |                                  |                   |   |                     |  |
|-----------------------------------|--------------------|-------|----------------------------|----------------------------------|-------------------|---|---------------------|--|
|                                   | Primary receptacle |       | Water spray<br>6.3.5.3.5.1 | Cold conditioning<br>6.3.5.3.5.2 | Drop<br>6.3.5.3   | Additional drop<br>6.3.5.3.5.3  | Puncture<br>6.3.5.4 | Stack<br>6.1.5.6   |
|                                   | Plastics           | Other | Number of samples          | Number of samples                | Number of samples | Number of samples   | Number of samples   | Number of samples  |
| Fibreboard box                    | x                  |       | 5                          | 5                                | 10                | Required on one sample when the packaging is intended to contain dry ice. | 2                   | Required on three samples when testing a “U”-marked packaging as defined in 6.3.5.1.6 for specific provisions. |
|                                   |                    | x     | 5                          | 0                                | 5                 |   | 2                   |  |
| Fibreboard drum                   | x                  |       | 3                          | 3                                | 6                 |   | 2                   |  |
|                                   |                    | x     | 3                          | 0                                | 3                 |   | 2                   |  |
| Plastics box                      | x                  |       | 0                          | 5                                | 5                 |   | 2                   |  |
|                                   |                    | x     | 0                          | 5                                | 5                 |   | 2                   |  |
| Plastics drum/jerrican            | x                  |       | 0                          | 3                                | 3                 |   | 2                   |  |
|                                   |                    | x     | 0                          | 3                                | 3                 |   | 2                   |  |
| Boxes of other material           | x                  |       | 0                          | 5                                | 5                 |   | 2                   |  |
|                                   |                    | x     | 0                          | 0                                | 5                 |   | 2                   |  |
| Drums/jerricans of other material | x                  |       | 0                          | 3                                | 3                 | 2   |                     |  |
|                                   |                    | x     | 0                          | 0                                | 3                 | 2   |                     |  |

<sup>a</sup> “Type of packaging” categorizes packagings for test purposes according to the kind of packaging and its material characteristics.

**Note 1:** In instances where a primary receptacle is made of two or more materials, the material most liable to damage determines the appropriate test.

**Note 2:** The materials of the secondary packagings are not taken into consideration when selecting the test or conditioning for the test.





*Explanation for use of the table:*

If the packaging to be tested consists of a fibreboard outer box with a plastics primary receptacle, five samples must undergo the water spray test (see 6.3.5.3.5.1) prior to dropping and another five must be conditioned to  $-18^{\circ}\text{C}$  (see 6.3.5.3.5.2) prior to dropping. If the packaging is to contain dry ice then one further single sample shall be dropped in accordance with 6.3.5.3.5.3.

Packagings prepared as for transport shall be subjected to the tests in 6.3.5.3 and 6.3.5.4. For outer packagings, the headings in the table relate to fibreboard or similar materials whose performance may be rapidly affected by moisture; plastics which may embrittle at low temperature; and other materials such as metal whose performance is not affected by moisture or temperature.

**6.3.5.3 Drop test****6.3.5.3.1 Drop height and target**

Samples shall be subjected to free-fall drops from a height of 9 m onto a non-resilient, horizontal, flat, massive and rigid surface in conformity with 6.1.5.3.4.

**6.3.5.3.2 Number of test samples and drop orientation**

6.3.5.3.2.1 Where the samples are in the shape of a box, five shall be dropped, one in each of the following orientations:

- .1 flat on the base;
- .2 flat on the top;
- .3 flat on the longest side;
- .4 flat on the shortest side; and
- .5 on a corner.

6.3.5.3.2.2 Where the samples are in the shape of a drum or a jerrican, three shall be dropped, one in each of the following orientations:

- .1 diagonally on the top edge, with the centre of gravity directly above the point of impact;
- .2 diagonally on the base edge; and
- .3 flat on the body or side.

6.3.5.3.3 While the sample shall be released in the required orientation, it is accepted that, for aerodynamic reasons, the impact may not take place in that orientation.

6.3.5.3.4 Following the appropriate drop sequence, there shall be no leakage from the primary receptacle(s), which shall remain protected by cushioning/absorbent material in the secondary packaging.

**6.3.5.3.5 Special preparation of test sample for the drop test****6.3.5.3.5.1 Fibreboard – Water spray test**

Fibreboard outer packagings: The sample shall be subjected to a water spray that simulates exposure to rainfall of approximately 5 cm per hour for at least one hour. It shall then be subjected to the test described in 6.3.5.3.1.

**6.3.5.3.5.2 Plastics material – Cold conditioning**

Plastics primary receptacles or outer packagings: The temperature of the test sample and its contents shall be reduced to  $-18^{\circ}\text{C}$  or lower for a period of at least 24 h and within 15 min of removal from that atmosphere the test sample shall be subjected to the test described in 6.3.5.3.1. Where the sample contains dry ice, the conditioning period shall be reduced to 4 hours.

**6.3.5.3.5.3 Packagings intended to contain dry ice – Additional drop test**

Where the packaging is intended to contain dry ice, a test additional to that specified in 6.3.5.3.1 and, when appropriate, in 6.3.5.3.5.1 or 6.3.5.3.5.2 shall be carried out. One sample shall be stored so that all the dry ice dissipates and then that sample shall be dropped in one of the orientations described in 6.3.5.3.2.1 or in 6.3.5.3.2.2, as appropriate; which shall be that most likely to result in failure of the packaging.

**6.3.5.4 Puncture test****6.3.5.4.1 Packagings with a gross mass of 7 kg or less**

Samples shall be placed on a level hard surface. A cylindrical steel rod with a mass of at least 7 kg, a diameter of 38 mm and the impact end edges having a radius not exceeding 6 mm (see below) shall be dropped in a vertical free fall from a height of 1 m, measured from the impact end to the impact surface of a sample. One

**Part 6 – Construction and testing of packagings, IBCs, etc.**

sample shall be placed on its base. A second sample shall be placed in an orientation perpendicular to that used for the first. In each instance, the steel rod shall be aimed to impact the primary receptacle. Following each impact, penetration of the secondary packaging is acceptable, provided that there is no leakage from the primary receptacle(s).

**6.3.5.4.2 Packagings with a gross mass exceeding 7 kg**

Samples shall be dropped on to the end of a cylindrical steel rod. The rod shall be set vertically in a level hard surface. It shall have a diameter of 38 mm and the edges of the upper end a radius not exceeding 6 mm (see below). The rod shall protrude from the surface a distance at least equal to that between the centre of the primary receptacle(s) and the outer surface of the outer packaging with a minimum of 200 mm. One sample shall be dropped with its top face lowermost in a vertical free fall from a height of 1 m, measured from the top of the steel rod. A second sample shall be dropped from the same height in an orientation perpendicular to that used for the first. In each instance, the packaging shall be so orientated that the steel rod would be capable of penetrating the primary receptacle(s). Following each impact, penetration of the secondary packaging is acceptable, provided that there is no leakage from the primary receptacle(s).

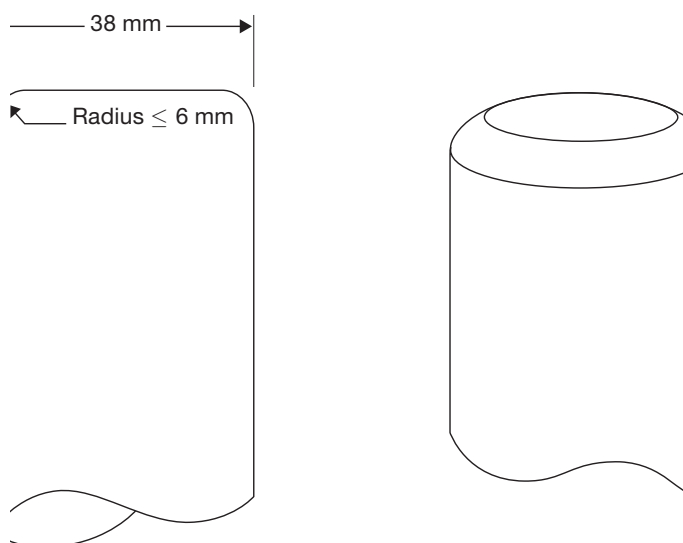
**6.3.5.5 Test report**

**6.3.5.5.1** A written test report containing at least the following particulars shall be drawn up and shall be available to the users of the packaging:

- .1 Name and address of the test facility;
- .2 Name and address of applicant (where appropriate);
- .3 A unique test report identification;
- .4 Date of the test and of the report;
- .5 Manufacturer of the packaging;
- .6 Description of the packaging design type (e.g. dimensions, materials, closures, thickness, etc.), including method of manufacture (e.g. blow moulding) and which may include drawing(s) and/or photograph(s);
- .7 Maximum capacity;
- .8 Test contents;
- .9 Test descriptions and results;
- .10 The test report shall be signed with the name and status of the signatory.

**6.3.5.5.2** The test report shall contain statements that the packaging prepared as for transport was tested in accordance with the appropriate requirements of this chapter and that the use of other packaging methods or components may render it invalid. A copy of the test report shall be available to the competent authority.

## Chapter 6.4

### *Provisions for the construction, testing and approval of packages for radioactive material and for the approval of such material*

**Note:** This chapter includes provisions which apply to the construction, testing and approval of certain packages and material only when transported by air. Whilst these provisions do not apply to packages/material transported by sea, the provisions are reproduced for information/identification purposes, since such packages/material, designed, tested and approved for air transport, may also be transported by sea.

6.4.1 [Reserved]

#### 6.4.2 General provisions

6.4.2.1 The package shall be so designed in relation to its mass, volume and shape that it can be easily and safely transported. In addition, the package shall be so designed that it can be properly secured in or on the conveyance during transport.

6.4.2.2 The design shall be such that any lifting attachments on the package will not fail when used in the intended manner and that, if failure of the attachments shall occur, the ability of the package to meet other provisions of this Code would not be impaired. The design shall take account of appropriate safety factors to cover snatch lifting.

6.4.2.3 Attachments and any other features on the outer surface of the package which could be used to lift it shall be designed either to support its mass in accordance with the provisions of 6.4.2.2 or shall be removable or otherwise rendered incapable of being used during transport.

6.4.2.4 As far as practicable, the packaging shall be so designed that the external surfaces are free from protruding features and can be easily decontaminated.

6.4.2.5 As far as practicable, the outer layer of the package shall be so designed as to prevent the collection and the retention of water.

6.4.2.6 Any features added to the package at the time of transport which are not part of the package shall not reduce its safety.

6.4.2.7 The package shall be capable of withstanding the effects of any acceleration, vibration or vibration resonance which may arise under routine conditions of transport without any deterioration in the effectiveness of the closing devices on the various receptacles or in the integrity of the package as a whole. In particular, nuts, bolts and other securing devices shall be so designed as to prevent them from becoming loose or being released unintentionally, even after repeated use.

6.4.2.8 The design of the package shall take into account ageing mechanisms.

6.4.2.9 The materials of the packaging and any components or structures shall be physically and chemically compatible with each other and with the radioactive contents. Account shall be taken of their behaviour under irradiation.

6.4.2.10 All valves through which the radioactive contents could escape shall be protected against unauthorized operation.

6.4.2.11 The design of the package shall take into account ambient temperatures and pressures that are likely to be encountered in routine conditions of transport.

6.4.2.12 A package shall be so designed that it provides sufficient shielding to ensure that, under routine conditions of transport and with the maximum radioactive contents that the package is designed to contain, the dose rate at any point on the external surface of the package would not exceed the values specified in 2.7.2.4.1.2, 4.1.9.1.11 and 4.1.9.1.12, as applicable, with account taken of 7.1.4.5.3.3 and 7.1.4.5.5.

**Part 6 – Construction and testing of packagings, IBCs, etc.**

6.4.2.13 For radioactive material having other dangerous properties, the package design shall take into account those properties; see 4.1.9.1.5, 2.0.3.1 and 2.0.3.2.

6.4.2.14 Manufacturers and subsequent distributors of packagings shall provide information regarding procedures to be followed and a description of the types and dimensions of closures (including required gaskets) and any other components needed to ensure that packages as presented for transport are capable of passing the applicable performance tests of this chapter.

**6.4.3 Additional provisions for packages transported by air**

6.4.3.1 For packages to be transported by air, the temperature of the accessible surfaces shall not exceed 50°C at an ambient temperature of 38°C with no account taken for insolation.

6.4.3.2 Packages to be transported by air shall be so designed that, if they were exposed to ambient temperatures ranging from –40°C to +55°C, the integrity of containment would not be impaired.

6.4.3.3 Packages containing radioactive material, to be transported by air, shall be capable of withstanding, without loss or dispersal of radioactive contents from the containment system, an internal pressure which produces a pressure differential of not less than maximum normal operating pressure plus 95 kPa.

**6.4.4 Provisions for excepted packages**

An excepted package shall be designed to meet the requirements specified in 6.4.2.1 to 6.4.2.12 and, in addition, the requirements of 6.4.7.2 if it contains fissile material allowed by one of the provisions of sub-paragraphs .1 to .6 of 2.7.2.3.5, and the requirements of 6.4.3 if transported by air.

**6.4.5 Provisions for industrial packages**

6.4.5.1 A Type IP-1 package shall be designed to meet the provisions specified in 6.4.2 and 6.4.7.2, and, in addition, shall meet the provisions of 6.4.3 if carried by air.

6.4.5.2 A package, to be qualified as a Type IP-2 package, shall be designed to meet the provisions for Type IP-1 as specified in 6.4.5.1 and, in addition, if it were subjected to the tests specified in 6.4.15.4 and 6.4.15.5, it would prevent:

- .1 loss or dispersal of the radioactive contents, and
- .2 more than a 20% increase in the maximum dose rate at any external surface of the package.

6.4.5.3 A package, to be qualified as a Type IP-3 package, shall be designed to meet the provisions for Type IP-1 as specified in 6.4.5.1 and, in addition, the provisions specified in 6.4.7.2–6.4.7.15.

**6.4.5.4 Alternative provisions for Type IP-2 and Type IP-3 packages**

6.4.5.4.1 Packages may be used as Type IP-2 package provided that:

- .1 they satisfy the provisions for Type IP-1 specified in 6.4.5.1;
- .2 they are designed to satisfy the provisions for packing group I or II in chapter 6.1 of this Code; and
- .3 when subjected to the tests for UN packing group I or II in chapter 6.1, they would prevent:
  - (i) loss or dispersal of the radioactive contents; and
  - (ii) more than a 20% increase in the maximum dose rate at any external surface of the package.

6.4.5.4.2 Portable tanks may also be used as Type IP-2 or Type IP-3 packages provided that:

- .1 they satisfy the provisions for Type IP-1 specified in 6.4.5.1;
- .2 they are designed to satisfy the provisions of chapter 6.7 of this Code, and are capable of withstanding a test pressure of 265 kPa; and
- .3 they are designed so that any shielding which is provided shall be capable of withstanding the static and dynamic stresses resulting from handling and routine conditions of transport and of preventing more than a 20% increase in the maximum dose rate at any external surface of the portable tanks.

6.4.5.4.3 Tanks, other than portable tanks, may also be used as Type IP-2 or Type IP-3 packages for transporting LSA-I and LSA-II as prescribed in the table under 4.1.9.2.5, provided that:

- .1 they satisfy the provisions of 6.4.5.1;
- .2 they are designed to satisfy the provisions prescribed in regional or national regulations for the transport of dangerous goods and are capable of withstanding a test pressure of 265 kPa; and

## Chapter 6.4 – Construction, testing and approval of packages for radioactive material

- .3 they are designed so that any additional shielding which is provided shall be capable of withstanding the static and dynamic stresses resulting from handling and routine conditions of transport and of preventing more than a 20% increase in the maximum dose rate at any external surface of the tanks.

6.4.5.4.4 Freight containers with the characteristics of a permanent enclosure may also be used as Type IP-2 or Type IP-3 packages provided that:

- .1 the radioactive contents are restricted to solid materials;
- .2 they satisfy the provisions for Type IP-1 specified in 6.4.5.1; and
- .3 they are designed to conform to the standards prescribed in ISO 1496-1:1990(E), *Series 1 Freight Containers – Specifications and Testing – Part 1: General Cargo Containers*, and subsequent amendments 1:1993, 2:1998, 3:2005, 4:2006 and 5:2006, excluding dimensions and ratings. They shall be designed such that, if subjected to the tests prescribed in that document and the accelerations occurring during routine conditions of transport, they would prevent:
  - .1 loss or dispersal of the radioactive contents; and
  - .2 more than a 20% increase in the maximum dose rate at any external surface of the package.

6.4.5.4.5 Metal intermediate bulk containers may also be used as Type IP-2 or Type IP-3 packages provided that:

- .1 they satisfy the provisions for Type IP-1 specified in 6.4.5.1; and
- .2 they are designed to satisfy the provisions of chapter 6.5 of this Code for packing group I or II, and if they were subjected to the tests prescribed in that chapter, but with the drop test conducted in the most damaging orientation, they would prevent:
  - .1 loss or dispersal of the radioactive contents; and
  - .2 more than a 20% increase in the maximum dose rate at any external surface of the package.

## 6.4.6 Provisions for packages containing uranium hexafluoride

6.4.6.1 Packages designed to contain uranium hexafluoride shall meet the requirements which pertain to the radioactive and fissile properties of the material prescribed elsewhere in this Code. Except as allowed in 6.4.6.4, uranium hexafluoride in quantities of 0.1 kg or more shall also be packaged and transported in accordance with ISO 7195:2005, *Nuclear energy – Packaging of uranium hexafluoride (UF<sub>6</sub>) for transport*, and the provisions of 6.4.6.2 to 6.4.6.3.

6.4.6.2 Each package designed to contain 0.1 kg or more of uranium hexafluoride shall be designed so that the package would meet the following provisions:

- .1 withstand, without leakage and without unacceptable stress, as specified in ISO 7195:2005, the structural test as specified in 6.4.21 except as allowed in 6.4.6.4;
- .2 withstand, without loss or dispersal of the uranium hexafluoride, the free drop test specified in 6.4.15.4; and
- .3 withstand, without rupture of the containment system, the thermal test specified in 6.4.17.3 except as allowed in 6.4.6.4.

6.4.6.3 Packages designed to contain 0.1 kg or more of uranium hexafluoride shall not be provided with pressure relief devices.

6.4.6.4 Subject to multilateral approval, packages designed to contain 0.1 kg or more of uranium hexafluoride may be transported if the packages are designed:

- (a) to international or national standards other than ISO 7195:2005, provided an equivalent level of safety is maintained;
- (b) to withstand, without leakage and without unacceptable stress, a test pressure of less than 2.76 MPa as specified in 6.4.21; and/or
- (c) to contain 9000 kg or more of uranium hexafluoride and the packages do not meet the requirement of 6.4.6.2.3.

In all other respects, the provisions of 6.4.6.1 to 6.4.6.3 shall be satisfied.

## 6.4.7 Provisions for Type A packages

6.4.7.1 Type A packages shall be designed to meet the general provisions of 6.4.2, shall meet the provisions of 6.4.3 if carried by air, and shall meet the provisions of 6.4.7.2–6.4.7.17.

6.4.7.2 The smallest overall external dimension of the package shall not be less than 10 cm.

*Part 6 – Construction and testing of packagings, IBCs, etc.*

- 6.4.7.3 The outside of the package shall incorporate a feature, such as a seal, which is not readily breakable and which, while intact, will be evidence that it has not been opened.
- 6.4.7.4 Any tie-down attachments on the package shall be so designed that, under normal and accident conditions of transport, the forces in those attachments shall not impair the ability of the package to meet the provisions of this Code.
- 6.4.7.5 The design of the package shall take into account temperatures ranging from  $-40^{\circ}\text{C}$  to  $+70^{\circ}\text{C}$  for the components of the packaging. Attention shall be given to freezing temperatures for liquids and to the potential degradation of packaging materials within the given temperature range.
- 6.4.7.6 The design and manufacturing techniques shall be in accordance with national or international standards, or other provisions, acceptable to the competent authority.
- 6.4.7.7 The design shall include a containment system securely closed by a positive fastening device which cannot be opened unintentionally or by a pressure which may arise within the package.
- 6.4.7.8 Special form radioactive material may be considered as a component of the containment system.
- 6.4.7.9 If the containment system forms a separate unit of the package, the containment system shall be capable of being securely closed by a positive fastening device which is independent of any other part of the packaging.
- 6.4.7.10 The design of any component of the containment system shall take into account, where applicable, the radiolytic decomposition of liquids and other vulnerable materials and the generation of gas by chemical reaction and radiolysis.
- 6.4.7.11 The containment system shall retain its radioactive contents under a reduction of ambient pressure to 60 kPa.
- 6.4.7.12 All valves, other than pressure relief valves, shall be provided with an enclosure to retain any leakage from the valve.
- 6.4.7.13 A radiation shield which encloses a component of the package specified as a part of the containment system shall be so designed as to prevent the unintentional release of that component from the shield. Where the radiation shield and such component within it form a separate unit, the radiation shield shall be capable of being securely closed by a positive fastening device which is independent of any other packaging structure.
- 6.4.7.14 A package shall be so designed that, if it were subjected to the tests specified in 6.4.15, it would prevent:
  - (a) loss or dispersal of the radioactive contents; and
  - (b) more than a 20% increase in the maximum dose rate at any external surface of the package.
- 6.4.7.15 The design of a package intended for liquid radioactive material shall make provision for ullage to accommodate variations in the temperature of the contents, dynamic effects and filling dynamics.

*Type A packages to contain liquids*

- 6.4.7.16 A Type A package designed to contain liquid radioactive material shall, in addition:
  - .1 be adequate to meet the conditions specified in 6.4.7.14(a) above if the package is subjected to the tests specified in 6.4.16; and
  - .2 either
    - (i) be provided with sufficient absorbent material to absorb twice the volume of the liquid contents. Such absorbent material must be suitably positioned so as to contact the liquid in the event of leakage; or
    - (ii) be provided with a containment system composed of primary inner and secondary outer containment components designed to enclose the liquid contents completely and ensure their retention within the secondary outer containment components even if the primary inner components leak.

*Type A packages to contain gas*

- 6.4.7.17 A Type A package designed for gases shall prevent loss or dispersal of the radioactive contents if the package were subjected to the tests specified in 6.4.16, except for a Type A package designed for tritium gas or for noble gases.

**6.4.8 Provisions for Type B(U) packages**

- 6.4.8.1 Type B(U) packages shall be designed to meet the requirements specified in 6.4.2, the requirements specified in 6.4.3 if carried by air, and of 6.4.7.2 to 6.4.7.15, except as specified in 6.4.7.14(a), and, in addition, the requirements specified in 6.4.8.2 to 6.4.8.15.



Chapter 6.4 – Construction, testing and approval of packages for radioactive material

- 6.4.8.2 A package shall be so designed that, under the ambient conditions specified in 6.4.8.5 and 6.4.8.6, heat generated within the package by the radioactive contents shall not, under normal conditions of transport, as demonstrated by the tests in 6.4.15, adversely affect the package in such a way that it would fail to meet the applicable provisions for containment and shielding if left unattended for a period of one week. Particular attention shall be paid to the effects of heat, which may cause one or more of the following:
- alter the arrangement, the geometrical form or the physical state of the radioactive contents or, if the radioactive material is enclosed in a can or receptacle (for example, clad fuel elements), cause the can, receptacle or radioactive material to deform or melt;
  - lessening of the efficiency of the packaging through differential thermal expansion or cracking or melting of the radiation shielding material;
  - in combination with moisture, accelerate corrosion.
- 6.4.8.3 A package shall be so designed that, under the ambient condition specified in 6.4.8.5 and in the absence of insolation, the temperature of the accessible surfaces of a package shall not exceed 50°C, unless the package is transported under exclusive use.
- 6.4.8.4 Except as required in 6.4.3.1 for a package transported by air, the maximum temperature of any surface readily accessible during transport of a package under exclusive use shall not exceed 85°C in the absence of insolation under the ambient conditions specified in 6.4.8.5. Account may be taken of barriers or screens intended to give protection to persons without the need for the barriers or screens being subject to any test.
- 6.4.8.5 The ambient temperature shall be assumed to be 38°C.
- 6.4.8.6 The solar insolation conditions shall be assumed to be as specified in the table hereunder.

Insolation data

| Case | Form and location of surface                             | Insolation for 12 hours per day (W/m <sup>2</sup> ) |
|------|--|---|
| 1    | Flat surfaces transported horizontally – downward facing | 0   |
| 2    | Flat surfaces transported horizontally – upward facing   | 800   |
| 3    | Surfaces transported vertically                          | 200*  |
| 4    | Other downward-facing (not horizontal) surfaces          | 200*  |
| 5    | All other surfaces                                       | 400*  |

\* Alternatively, a sine function may be used, with an absorption coefficient adopted and the effects of possible reflection from neighbouring objects neglected.

- 6.4.8.7 A package which includes thermal protection for the purpose of satisfying the provisions of the thermal test specified in 6.4.17.3 shall be so designed that such protection will remain effective if the package is subjected to the tests specified in 6.4.15 and 6.4.17.2(a) and (b) or 6.4.17.2(b) and (c), as appropriate. Any such protection on the exterior of the package shall not be rendered ineffective by ripping, cutting, skidding, abrasion or rough handling.
- 6.4.8.8 A package shall be so designed that, if it were subjected to:
- the tests specified in 6.4.15, it would restrict the loss of radioactive contents to not more than  $10^{-6}A_2$  per hour; and
  - the tests specified in 6.4.17.1, 6.4.17.2(b), 6.4.17.3 and 6.4.17.4 and either the test in:
    - 6.4.17.2(c), when the package has a mass not greater than 500 kg, an overall density not greater than 1,000 kg/m<sup>3</sup> based on the external dimensions, and radioactive contents greater than  $1,000A_2$  not as special form radioactive material, or
    - 6.4.17.2(a), for all other packages,
 it would meet the following provisions:
    - retain sufficient shielding to ensure that the dose rate at 1 m from the surface of the package would not exceed 10 mSv/h with the maximum radioactive contents which the package is designed to contain; and
    - restrict the accumulated loss of radioactive contents in a period of one week to not more than  $10A_2$  for krypton-85 and not more than  $A_2$  for all other radionuclides.

Where mixtures of different radionuclides are present, the provisions of 2.7.2.2.4–2.7.2.2.6 shall apply except that for krypton-85 an effective  $A_2(i)$  value equal to  $10A_2$  may be used. For case .1 above, the assessment shall take into account the external non-fixed contamination limits of 4.1.9.1.2.



**Part 6 – Construction and testing of packagings, IBCs, etc.**

- 6.4.8.9 A package for radioactive contents with activity greater than  $10^5 A_2$  shall be so designed that, if it were subjected to the enhanced water immersion test specified in 6.4.18, there would be no rupture of the containment system.
- 6.4.8.10 Compliance with the permitted activity release limits shall depend neither upon filters nor upon a mechanical cooling system.
- 6.4.8.11 A package shall not include a pressure relief system from the containment system which would allow the release of radioactive material to the environment under the conditions of the tests specified in 6.4.15 and 6.4.17.
- 6.4.8.12 A package shall be so designed that, if it were at the maximum normal operating pressure and it were subjected to the tests specified in 6.4.15 and 6.4.17, the level of strains in the containment system would not attain values which would adversely affect the package in such a way that it would fail to meet the applicable provisions.
- 6.4.8.13 A package shall not have a maximum normal operating pressure in excess of a gauge pressure of 700 kPa.
- 6.4.8.14 A package containing low dispersible radioactive material shall be so designed that any features added to the low dispersible radioactive material that are not part of it, or any internal components of the packaging, shall not adversely affect the performance of the low dispersible radioactive material.
- 6.4.8.15 A package shall be designed for an ambient temperature range from  $-40^\circ\text{C}$  to  $+38^\circ\text{C}$ .

**6.4.9 Provisions for Type B(M) packages**

- 6.4.9.1 Type B(M) packages shall meet the provisions for Type B(U) packages specified in 6.4.8.1, except that, for packages to be transported solely within a specified country or solely between specified countries, conditions other than those given in 6.4.7.5, 6.4.8.4 to 6.4.8.6 and 6.4.8.9 to 6.4.8.15 above may be assumed, with the approval of the competent authorities of these countries. The provisions for Type B(U) packages specified in 6.4.8.4 and 6.4.8.9 to 6.4.8.15 shall be met as far as practicable.
- 6.4.9.2 Intermittent venting of Type B(M) packages may be permitted during transport, provided that the operational controls for venting are acceptable to the relevant competent authorities.

**6.4.10 Provisions for Type C packages**

- 6.4.10.1 Type C packages shall be designed to meet the provisions specified in 6.4.2 and 6.4.3, and of 6.4.7.2 to 6.4.7.15, except as specified in 6.4.7.14, and of the provisions specified in 6.4.8.2 to 6.4.8.6, 6.4.8.10 to 6.4.8.15, and, in addition, of 6.4.10.2–6.4.10.4.
- 6.4.10.2 A package shall be capable of meeting the assessment criteria prescribed for tests in 6.4.8.8.2 and 6.4.8.12 after burial in an environment defined by a thermal conductivity of  $0.33 \text{ W/(m}\cdot\text{K)}$  and a temperature of  $38^\circ\text{C}$  in the steady state. Initial conditions for the assessment shall assume that any thermal insulation of the package remains intact, the package is at the maximum normal operating pressure and the ambient temperature is  $38^\circ\text{C}$ .
- 6.4.10.3 A package shall be so designed that, if it were at the maximum normal operating pressure and subjected to:
- (a) the tests specified in 6.4.15, it would restrict the loss of radioactive contents to not more than  $10^{-6} A_2$  per hour; and
  - (b) the test sequences in 6.4.20.1,
    - (i) it would retain sufficient shielding to ensure that the dose rate at 1 m from the surface of the package would not exceed  $10 \text{ mSv/h}$  with the maximum radioactive contents which the package is designed to contain; and
    - (ii) it would restrict the accumulated loss of radioactive contents in a period of 1 week to not more than  $10 A_2$  for krypton-85 and not more than  $A_2$  for all other radionuclides.

Where mixtures of different radionuclides are present, the provisions of 2.7.2.2.4 to 2.7.2.2.6 shall apply except that for krypton-85 an effective  $A_2(i)$  value equal to  $10 A_2$  may be used. For case (a) above, the assessment shall take into account the external contamination limits of 4.1.9.1.2.

- 6.4.10.4 A package shall be so designed that there will be no rupture of the containment system following performance of the enhanced water immersion test specified in 6.4.18.

**6.4.11 Provisions for packages containing fissile material**

- 6.4.11.1 Fissile material shall be transported so as to:
- (a) maintain subcriticality during routine, normal and accident conditions of transport; in particular, the following contingencies shall be considered:
    - (i) water leaking into or out of packages;

## Chapter 6.4 – Construction, testing and approval of packages for radioactive material

- (ii) the loss of efficiency of built-in neutron absorbers or moderators;
  - (iii) rearrangement of the contents either within the package or as a result of loss from the package;
  - (iv) reduction of spaces within or between packages;
  - (v) packages becoming immersed in water or buried in snow; and
  - (vi) temperature changes; and
- (b) meet the provisions:
- (i) of 6.4.7.2 except for unpackaged material when specifically allowed by 2.7.2.3.5.5;
  - (ii) prescribed elsewhere in this Code which pertain to the radioactive properties of the material;
  - (iii) of 6.4.7.3 unless the material is excepted by 2.7.2.3.5;
  - (iv) of 6.4.11.4 to 6.4.11.14, unless the material is excepted by 2.7.2.3.5, 6.4.11.2 or 6.4.11.3.

**6.4.11.2** Packages containing fissile material that meet the provisions of subparagraph (d) and one of the provisions of (a) to (c) below are excepted from the requirements of 6.4.11.4 to 6.4.11.14.

- (a) Packages containing fissile material in any form provided that:
- (i) the smallest external dimension of the package is not less than 10 cm;
  - (ii) the criticality safety index (CSI) of the package is calculated using the following formula:

$$CSI = 50 \times 5 \times \left( \frac{\text{Mass of U-235 in package (g)}}{Z} + \frac{\text{Mass of other fissile nuclides* in package (g)}}{280} \right)$$

\* Plutonium may be of any isotopic composition provided that the amount of Pu-241 is less than that of Pu-240 in the package.

where the values of  $Z$  are taken from table 6.4.11.2;

- (iii) the CSI of any package does not exceed 10.
- (b) Packages containing fissile material in any form provided that:
- (i) the smallest external dimension of the package is not less than 30 cm;
  - (ii) the package, after being subjected to the tests specified in 6.4.15.1 to 6.4.15.6:
    - retains its fissile material contents;
    - preserves the minimum overall outside dimensions of the package to at least 30 cm;
    - prevents the entry of a 10 cm cube;
  - (iii) the CSI of the package is calculated using the following formula:

$$CSI = 50 \times 2 \times \left( \frac{\text{Mass of U-235 in package (g)}}{Z} + \frac{\text{Mass of other fissile nuclides* in package (g)}}{280} \right)$$

\* Plutonium may be of any isotopic composition provided that the amount of Pu-241 is less than that of Pu-240 in the package.

where the values of  $Z$  are taken from table 6.4.11.2.

- (iv) the CSI of any package does not exceed 10;
- (c) Packages containing fissile material in any form provided that:
- (i) the smallest external dimension of the package is not less than 10 cm;
  - (ii) the package, after being subjected to the tests specified in 6.4.15.1 to 6.4.15.6:
    - retains its fissile material contents;
    - preserves the minimum overall outside dimensions of the package to at least 10 cm;
    - prevents the entry of a 10 cm cube.
  - (iii) the CSI of the package is calculated using the following formula:

$$CSI = 50 \times 2 \times \left( \frac{\text{Mass of U-235 in package (g)}}{450} + \frac{\text{Mass of other fissile nuclides* in package (g)}}{280} \right)$$

\* Plutonium may be of any isotopic composition provided that the amount of Pu-241 is less than that of Pu-240 in the package.

- (iv) The total mass of fissile nuclides in any package does not exceed 15 g;
- (d) The total mass of beryllium, hydrogenous material enriched in deuterium, graphite and other allotropic forms of carbon in an individual package shall not be greater than the mass of fissile nuclides in the package except where the total concentration of these materials does not exceed 1 g in any 1,000 g of material. Beryllium incorporated in copper alloys up to 4% in weight of the alloy does not need to be considered.

## Part 6 – Construction and testing of packagings, IBCs, etc.

Table 6.4.11.2 – Values of Z for calculation of criticality safety index in accordance with 6.4.11.2

| Enrichment <sup>a</sup>     | Z     |
|-----------------------------|-------|
| Uranium enriched up to 1.5% | 2,200 |
| Uranium enriched up to 5%   | 850   |
| Uranium enriched up to 10%  | 660   |
| Uranium enriched up to 20%  | 580   |
| Uranium enriched up to 100% | 450   |

<sup>a</sup> If a package contains uranium with varying enrichments of U-235, then the value corresponding to the highest enrichment shall be used for Z.

- 6.4.11.3** Packages containing not more than 1,000 g of plutonium are excepted from the application of 6.4.11.4 to 6.4.11.14 provided that:
- not more than 20% of the plutonium by mass is fissile nuclides;
  - the criticality safety index of the package is calculated using the following formula:
 
$$CSI = 50 \times 2 \times \frac{\text{mass of plutonium (g)}}{1,000}$$
  - if uranium is present with the plutonium, the mass of uranium shall be no more than 1% of the mass of the plutonium.
- 6.4.11.4** Where the chemical or physical form, isotopic composition, mass or concentration, moderation ratio or density, or geometric configuration is not known, the assessments of 6.4.11.8 to 6.4.11.13 shall be performed assuming that each parameter that is not known has the value which gives the maximum neutron multiplication consistent with the known conditions and parameters in these assessments.
- 6.4.11.5** For irradiated nuclear fuel, the assessments of 6.4.11.8 to 6.4.11.13 shall be based on an isotopic composition demonstrated to provide either:
- the maximum neutron multiplication during the irradiation history; or
  - a conservative estimate of the neutron multiplication for the package assessments. After irradiation, but prior to shipment, a measurement shall be performed to confirm the conservatism of the isotopic composition.
- 6.4.11.6** The package, after being subjected to the tests specified in 6.4.15, shall:
- preserve the minimum overall outside dimensions of the package to at least 10 cm; and
  - prevent the entry of a 10 cm cube.
- 6.4.11.7** The package shall be designed for an ambient temperature range of  $-40^{\circ}\text{C}$  to  $+38^{\circ}\text{C}$  unless the competent authority specifies otherwise in the certificate of approval for the package design.
- 6.4.11.8** For a package in isolation, it shall be assumed that water can leak into or out of all void spaces of the package, including those within the containment system. However, if the design incorporates special features to prevent such leakage of water into or out of certain void spaces, even as a result of error, absence of leakage may be assumed in respect of those void spaces. Special features shall include either of the following:
- multiple high-standard water barriers, not less than two of which would remain watertight if the package were subject to the tests prescribed in 6.4.11.13(b), a high degree of quality control in the manufacture, maintenance and repair of packagings and tests to demonstrate the closure of each package before each shipment; or
  - for packages containing uranium hexafluoride only, with maximum enrichment of 5 mass percent uranium-235:
    - packages where, following the tests prescribed in 6.4.11.13(b), there is no physical contact between the valve or the plug and any other component of the packaging other than at its original point of attachment and where, in addition, following the test prescribed in 6.4.17.3, the valves and the plug remain leaktight; and
    - a high degree of quality control in the manufacture, maintenance and repair of packagings coupled with tests to demonstrate closure of each package before each shipment.
- 6.4.11.9** It shall be assumed that the confinement system is closely reflected by at least 20 cm of water or such greater reflection as may additionally be provided by the surrounding material of the packaging. However, when it can be demonstrated that the confinement system remains within the packaging following the tests prescribed in 6.4.11.13(b), close reflection of the package by at least 20 cm of water may be assumed in 6.4.11.10(c).

## Chapter 6.4 – Construction, testing and approval of packages for radioactive material

- 6.4.11.10** The package shall be subcritical under the conditions of 6.4.11.8 and 6.4.11.9 and with the package conditions that result in the maximum neutron multiplication consistent with:
- routine conditions of transport (incident-free);
  - the tests specified in 6.4.11.12(b);
  - the tests specified in 6.4.11.13(b).
- 6.4.11.11** For packages to be transported by air:
- the package shall be subcritical under conditions consistent with the Type C package tests specified in 6.4.20.1 assuming reflection by at least 20 cm of water but no water in-leakage; and
  - in the assessment of 6.4.11.10, use of special features as specified in 6.4.11.8 is allowed provided that leakage of water into or out of the void spaces is prevented when the package is submitted to the Type C package tests specified in 6.4.20.1 followed by the water leakage test specified in 6.4.19.3.
- 6.4.11.12** A number “*N*” shall be derived, such that five times “*N*” packages shall be subcritical for the arrangement and package conditions that provide the maximum neutron multiplication consistent with the following:
- there shall not be anything between the packages, and the package arrangement shall be reflected on all sides by at least 20 cm of water; and
  - the state of the packages shall be their assessed or demonstrated condition if they had been subjected to the tests specified in 6.4.15.
- 6.4.11.13** A number “*N*” shall be derived, such that two times “*N*” packages shall be subcritical for the arrangement and package conditions that provide the maximum neutron multiplication consistent with the following:
- hydrogenous moderation between packages, and the package arrangement reflected on all sides by at least 20 cm of water; and
  - the tests specified in 6.4.15 followed by whichever of the following is the more limiting:
    - the tests specified in 6.4.17.2(b) and either 6.4.17.2(c), for packages having a mass not greater than 500 kg and an overall density not greater than 1000 kg/m<sup>3</sup> based on the external dimensions, or 6.4.17.2(a), for all other packages; followed by the test specified in 6.4.17.3 and completed by the tests specified in 6.4.19.1–6.4.19.3; or
    - the test specified in 6.4.17.4; and
  - where any part of the fissile material escapes from the containment system following the tests specified in 6.4.11.13(b), it shall be assumed that fissile material escapes from each package in the array and all of the fissile material shall be arranged in the configuration and moderation that results in the maximum neutron multiplication with close reflection by at least 20 cm of water.
- 6.4.11.14** The criticality safety index (CSI) for packages containing fissile material shall be obtained by dividing the number 50 by the smaller of the two values of *N* derived in 6.4.11.12 and 6.4.11.13 (i.e.  $CSI = 50/N$ ). The value of the criticality safety index may be zero, provided that an unlimited number of packages is subcritical (i.e. *N* is effectively equal to infinity in both cases).

## 6.4.12 Test procedures and demonstration of compliance

- 6.4.12.1** Demonstration of compliance with the performance standards required in 2.7.2.3.3.1, 2.7.2.3.3.2, 2.7.2.3.4.1, 2.7.2.3.4.2, 2.7.2.3.4.3 and 6.4.2–6.4.11 shall be accomplished by any of the methods listed below or by a combination thereof.
- Performance of tests with specimens representing special form radioactive material, or low dispersible radioactive material or with prototypes or samples of the packaging, where the contents of the specimen or the packaging for the tests shall simulate as closely as practicable the expected range of radioactive contents and the specimen or packaging to be tested shall be prepared as presented for transport.
  - Reference to previous satisfactory demonstrations of a sufficiently similar nature.
  - Performance of tests with models of appropriate scale incorporating those features which are significant with respect to the item under investigation when engineering experience has shown results of such tests to be suitable for design purposes. When a scale model is used, the need for adjusting certain test parameters, such as penetrator diameter or compressive load, shall be taken into account.
  - Calculation, or reasoned argument, when the calculation procedures and parameters are generally agreed to be reliable or conservative.
- 6.4.12.2** After the specimen, prototype or sample has been subjected to the tests, appropriate methods of assessment shall be used to assure that the provisions of this chapter have been fulfilled in compliance with the performance and acceptance standards prescribed in this chapter (see 2.7.2.3.3.1, 2.7.2.3.3.2, 2.7.2.3.4.1, 2.7.2.3.4.2, 2.7.2.3.4.3 and 6.4.2–6.4.11).

Part 6 – Construction and testing of packagings, IBCs, etc.

- 6.4.12.3** All specimens shall be inspected before testing in order to identify and record faults or damage, including the following:
- (a) divergence from the design;
  - (b) defects in manufacture;
  - (c) corrosion or other deterioration; and
  - (d) distortion of features.

The containment system of the package shall be clearly specified. The external features of the specimen shall be clearly identified so that reference may be made simply and clearly to any part of such specimen.

**6.4.13 Testing the integrity of the containment system and shielding and evaluating criticality safety**

After each test or group of tests or sequence of the applicable tests, as appropriate, specified in 6.4.15 to 6.4.21:

- (a) faults and damage shall be identified and recorded;
- (b) it shall be determined whether the integrity of the containment system and shielding has been retained to the extent required in this chapter for the package under test; and
- (c) for packages containing fissile material, it shall be determined whether the assumptions and conditions used in the assessments required by 6.4.11.1 to 6.4.11.14 for one or more packages are valid.

**6.4.14 Target for drop tests**

The target for the drop tests specified in 2.7.2.3.3.5.1, 6.4.15.4, 6.4.16(a), 6.4.17.2 and 6.4.20.2 shall be a flat, horizontal surface of such a character that any increase in its resistance to displacement or deformation upon impact by the specimen would not significantly increase the damage to the specimen.

**6.4.15 Test for demonstrating ability to withstand normal conditions of transport**

**6.4.15.1** The tests are: the water spray test, the free drop test, the stacking test and the penetration test. Specimens of the package shall be subjected to the free drop test, the stacking test and the penetration test, preceded in each case by the water spray test. One specimen may be used for all the tests, provided that the provisions of 6.4.15.2 are fulfilled.

**6.4.15.2** The time interval between the conclusion of the water spray test and the succeeding test shall be such that the water has soaked in to the maximum extent, without appreciable drying of the exterior of the specimen. In the absence of any evidence to the contrary, this interval shall be taken to be two hours if the water spray is applied from four directions simultaneously. No time interval shall elapse, however, if the water spray is applied from each of the four directions consecutively.

**6.4.15.3** Water spray test: The specimen shall be subjected to a water spray test that simulates exposure to rainfall of approximately 5 cm per hour for at least one hour.

**6.4.15.4** Free drop test: The specimen shall drop onto the target so as to suffer maximum damage in respect of the safety features to be tested.

- (a) The height of the drop measured from the lowest point of the specimen to the upper surface of the target, shall be not less than the distance specified in the table hereunder for the applicable mass. The target shall be as defined in 6.4.14.
- (b) For rectangular fibreboard or wood packages not exceeding a mass of 50 kg, a separate specimen shall be subjected to a free drop onto each corner from a height of 0.3 m.
- (c) For cylindrical fibreboard packages not exceeding a mass of 100 kg, a separate specimen shall be subjected to a free drop onto each of the quarters of each rim from a height of 0.3 m.

**Free drop distance for testing packages to normal conditions of transport**

| Package mass (kg)              | Free drop distance (m) |
|--------------------------------|------------------------|
| Package mass < 5,000           | 1.2                    |
| 5,000 ≤ Package mass < 10,000  | 0.9                    |
| 10,000 ≤ Package mass < 15,000 | 0.6                    |
| 15,000 ≤ Package mass          | 0.3                    |



## Chapter 6.4 – Construction, testing and approval of packages for radioactive material

- 6.4.15.5** Stacking test: Unless the shape of the packaging effectively prevents stacking, the specimen shall be subjected, for a period of 24 hours, to a compressive load equal to the greater of the following:
- the equivalent of 5 times the maximum weight of the package; and
  - the equivalent of 13 kPa multiplied by the vertically projected area of the package.

The load shall be applied uniformly to two opposite sides of the specimen, one of which shall be the base on which the package would typically rest.

- 6.4.15.6** Penetration test: The specimen shall be placed on a rigid, flat, horizontal surface which will not move significantly while the test is being carried out.
- A bar of 3.2 cm in diameter with a hemispherical end and a mass of 6 kg shall be dropped and directed to fall, with its longitudinal axis vertical, onto the centre of the weakest part of the specimen, so that, if it penetrates sufficiently far, it will hit the containment system. The bar shall not be significantly deformed by the test performance.
  - The height of the drop of the bar, measured from its lower end to the intended point of impact on the upper surface of the specimen, shall be 1 m.

### 6.4.16 Additional tests for Type A packages designed for liquids and gases

A specimen or separate specimens shall be subjected to each of the following tests unless it can be demonstrated that one test is more severe for the specimen in question than the other, in which case one specimen shall be subjected to the more severe test.

- Free drop test: The specimen shall drop onto the target so as to suffer the maximum damage in respect of containment. The height of the drop measured from the lowest part of the specimen to the upper surface of the target shall be 9 m. The target shall be as defined in 6.4.14.
- Penetration test: The specimen shall be subjected to the test specified in 6.4.15.6 except that the height of drop shall be increased to 1.7 m from the 1 m specified in 6.4.15.6(b).

### 6.4.17 Tests for demonstrating ability to withstand accident conditions of transport

- 6.4.17.1** The specimen shall be subjected to the cumulative effects of the tests specified in 6.4.17.2 and 6.4.17.3, in that order. Following these tests, either this specimen or a separate specimen shall be subjected to the effect(s) of the water immersion test(s) as specified in 6.4.17.4 and, if applicable, 6.4.18.

- 6.4.17.2** Mechanical test: The mechanical test consists of three different drop tests. Each specimen shall be subjected to the applicable drops as specified in 6.4.8.8 or 6.4.11.13. The order in which the specimen is subjected to the drops shall be such that, on completion of the mechanical test, the specimen shall have suffered such damage as will lead to the maximum damage in the thermal test which follows.

- For drop I, the specimen shall drop onto the target so as to suffer the maximum damage, and the height of the drop measured from the lowest point of the specimen to the upper surface of the target shall be 9 m. The target shall be as defined in 6.4.14.
- For drop II, the specimen shall drop onto a bar rigidly mounted perpendicularly on the target so as to suffer the maximum damage. The height of the drop measured from the intended point of impact of the specimen to the upper surface of the bar shall be 1 m. The bar shall be of solid mild steel of circular cross-section,  $(15.0 \pm 0.5)$  cm in diameter and 20 cm long unless a longer bar would cause greater damage, in which case a bar of sufficient length to cause maximum damage shall be used. The upper end of the bar shall be flat and horizontal with its edge rounded off to a radius of not more than 6 mm. The target on which the bar is mounted shall be as described in 6.4.14.
- For drop III, the specimen shall be subjected to a dynamic crush test by positioning the specimen on the target so as to suffer maximum damage by the drop of a 500 kg mass from 9 m onto the specimen. The mass shall consist of a solid mild steel plate 1 m by 1 m and shall fall in a horizontal attitude. The lower face of the steel plate shall have its edges and corners rounded off to a radius of not more than 6 mm. The height of the drop shall be measured from the underside of the plate to the highest point of the specimen. The target on which the specimen rests shall be as defined in 6.4.14.

- 6.4.17.3** Thermal test: The specimen shall be in thermal equilibrium under conditions of an ambient temperature of 38°C, subject to the solar insolation conditions specified in the table under 6.4.8.6 and subject to the design maximum rate of internal heat generation within the package from the radioactive contents. Alternatively, any of these parameters are allowed to have different values prior to and during the test, providing due account is taken of them in the subsequent assessment of package response.

The thermal test shall then consist of:

- exposure of a specimen for a period of 30 minutes to a thermal environment which provides a heat flux at least equivalent to that of a hydrocarbon fuel/air fire in sufficiently quiescent ambient conditions to give a minimum average flame emissivity coefficient of 0.9 and an average temperature of at least 800°C, fully



**Part 6 – Construction and testing of packagings, IBCs, etc.**

engulfing the specimen, with a surface absorptivity coefficient of 0.8 or that value which the package may be demonstrated to possess if exposed to the fire specified, followed by:

- (b) exposure of the specimen to an ambient temperature of 38°C, subject to the solar insolation conditions specified in the table under 6.4.8.6 and subject to the design maximum rate of internal heat generation within the package by the radioactive contents, for a sufficient period to ensure that temperatures in the specimen are decreasing in all parts of the specimen and/or are approaching initial steady-state conditions. Alternatively, any of these parameters are allowed to have different values following cessation of heating, providing due account is taken of them in the subsequent assessment of package response.

During and following the test, the specimen shall not be artificially cooled and any combustion of materials of the specimen shall be permitted to proceed naturally.

- 6.4.17.4 Water immersion test: The specimen shall be immersed under a head of water of at least 15 m for a period of not less than eight hours in the attitude which will lead to maximum damage. For demonstration purposes, an external gauge pressure of at least 150 kPa shall be considered to meet these conditions.

#### 6.4.18 Enhanced water immersion test for Type B(U) and Type B(M) packages containing more than $10^5 A_2$ and Type C packages

Enhanced water immersion test: The specimen shall be immersed under a head of water of at least 200 m for a period of not less than one hour. For demonstration purposes, an external gauge pressure of at least 2 MPa shall be considered to meet these conditions.

#### 6.4.19 Water leakage test for packages containing fissile material

- 6.4.19.1 Packages for which water in-leakage or out-leakage to the extent which results in greatest reactivity has been assumed for purposes of assessment under 6.4.11.8 to 6.4.11.13 shall be excepted from the test.
- 6.4.19.2 Before the specimen is subjected to the water leakage test specified below, it shall be subjected to the tests in 6.4.17.2(b), and either 6.4.17.2(a) or (c) as required by 6.4.11.13, and the test specified in 6.4.17.3.
- 6.4.19.3 The specimen shall be immersed under a head of water of at least 0.9 m for a period of not less than eight hours and in the attitude for which maximum leakage is expected.

#### 6.4.20 Tests for Type C packages

- 6.4.20.1 Specimens shall be subjected to the effects of each of the following test sequences in the orders specified:
- (a) the tests specified in 6.4.17.2(a), 6.4.17.2(c), 6.4.20.2 and 6.4.20.3; and
  - (b) the test specified in 6.4.20.4.
- Separate specimens are allowed to be used for each of the sequences (a) and (b).
- 6.4.20.2 Puncture/tearing test: The specimen shall be subjected to the damaging effects of a vertical, solid probe made of mild steel. The orientation of the package specimen and the impact point on the package surface shall be such as to cause maximum damage at the conclusion of the test sequence specified in 6.4.20.1(a).
- (a) The specimen, representing a package having a mass less than 250 kg, shall be placed on a target and subjected to a probe having a mass of 250 kg falling from a height of 3 m above the intended impact point. For this test, the probe shall be a 20 cm diameter cylindrical bar with the striking end forming a frustum of a right circular cone with the following dimensions: 30 cm height and 2.5 cm in diameter at the top with its edge rounded off to a radius of not more than 6 mm. The target on which the specimen is placed shall be as specified in 6.4.14.
  - (b) For packages having a mass of 250 kg or more, the base of the probe shall be placed on a target and the specimen dropped onto the probe. The height of the drop, measured from the point of impact with the specimen to the upper surface of the probe, shall be 3 m. For this test, the probe shall have the same properties and dimensions as specified in (a) above, except that the length and mass of the probe shall be such as to incur maximum damage to the specimen. The target on which the base of the probe is placed shall be as specified in 6.4.14.
- 6.4.20.3 Enhanced thermal test: The conditions for this test shall be as specified in 6.4.17.3, except that the exposure to the thermal environment shall be for a period of 60 min.
- 6.4.20.4 Impact test: The specimen shall be subject to an impact on a target at a velocity of not less than 90 m/s, at such an orientation as to suffer maximum damage. The target shall be as defined in 6.4.14, except that the target surface may be at any orientation provided that the surface is normal to the specimen path.



### 6.4.21 Tests for packagings designed to contain uranium hexafluoride

Specimens that comprise or simulate packagings designed to contain 0.1 kg or more of uranium hexafluoride shall be tested hydraulically at an internal pressure of at least 1.38 MPa but, when the test pressure is less than 2.76 MPa, the design will require multilateral approval. For retesting packagings, any other equivalent non-destructive testing may be applied, subject to multilateral approval.

### 6.4.22 Approvals of package designs and materials

6.4.22.1 The approval of designs for packages containing 0.1 kg or more of uranium hexafluoride requires that:

- (a) Each design that meets the provisions of 6.4.6.4 shall require multilateral approval;
- (b) Each design that meets the provisions of 6.4.6.1 to 6.4.6.3 shall require unilateral approval by the competent authority of the country of origin of the design, unless multilateral approval is otherwise required by this Code.

6.4.22.2 Each Type B(U) and Type C package design will require unilateral approval, except that:

- (a) a package design for fissile material which is also subject to 6.4.22.4, 6.4.23.7 and 5.1.5.2.1 will require multilateral approval; and
- (b) a Type B(U) package design for low dispersible radioactive material will require multilateral approval.

6.4.22.3 Each Type B(M) package design, including those for fissile material which are also subject to 6.4.22.4, 6.4.23.7 and 5.1.5.2.1 and those for low dispersible radioactive material, will require multilateral approval.

6.4.22.4 Each package design for fissile material which is not excepted by any of the paragraphs 2.7.2.3.5.1 to 2.7.2.3.5.6, 6.4.11.2 and 6.4.11.3 shall require multilateral approval.

6.4.22.5 The design for special form radioactive material will require unilateral approval. The design for low dispersible radioactive material will require multilateral approval (see also 6.4.23.8).

6.4.22.6 The design for a fissile material excepted from "FISSILE" classification in accordance with 2.7.2.3.5.6 shall require multilateral approval.

6.4.22.7 Alternative activity limits for an exempt consignment of instruments or articles in accordance with 2.7.2.2.2.2 shall require multilateral approval.

### 6.4.23 Applications for approval and approvals for radioactive material transport

6.4.23.1 [Reserved]

6.4.23.2 An application for approval of shipment shall include:

- (a) the period of time, related to the shipment, for which the approval is sought;
- (b) the actual radioactive contents, the expected modes of transport, the type of conveyance, and the probable or proposed route; and
- (c) the details of how the precautions and administrative or operational controls referred to in the certificate of approval for the package design, if applicable, issued under 5.1.5.2.1.1.3, 5.1.5.2.1.1.6 or 5.1.5.2.1.1.7, are to be put into effect.

6.4.23.2.1 An application for approval of SCO-III shipments shall include:

- (a) a statement of the respects in which, and of the reasons why, the consignment is considered SCO-III;
- (b) justification for choosing SCO-III by demonstrating that:
  - (i) no suitable packaging currently exists;
  - (ii) designing and/or constructing a packaging or segmenting the object is not practically, technically or economically feasible;
  - (iii) no other viable alternative exists;
- (c) a detailed description of the proposed radioactive contents with reference to their physical and chemical states and the nature of the radiation emitted;
- (d) a detailed statement of the design of the SCO-III, including complete engineering drawings and schedules of materials and methods of manufacture;
- (e) all information necessary to satisfy the competent authority that the requirements of 4.1.9.2.4.5 and the requirements of 7.1.4.5.1, if applicable, are satisfied;
- (f) a transport plan;
- (g) a specification of the applicable management system as required in 1.5.3.1.

**Part 6 – Construction and testing of packagings, IBCs, etc.**

- 6.4.23.3** An application for approval of shipments under special arrangement shall include all the information necessary to satisfy the competent authority that the overall level of safety in transport is at least equivalent to that which would be provided if all the applicable provisions of this Code had been met. The application shall also include:
- (a) a statement of the respects in which, and of the reasons why, the shipment cannot be made in full accordance with the applicable provisions; and
  - (b) a statement of any special precautions or special administrative or operational controls which are to be employed during transport to compensate for the failure to meet the applicable provisions.
- 6.4.23.4** An application for approval of Type B(U) or Type C package design shall include:
- (a) a detailed description of the proposed radioactive contents with reference to their physical and chemical states and the nature of the radiation emitted;
  - (b) a detailed statement of the design, including complete engineering drawings and schedules of materials and methods of manufacture;
  - (c) a statement of the tests which have been done and their results, or evidence based on calculative methods or other evidence that the design is adequate to meet the applicable provisions;
  - (d) the proposed operating and maintenance instructions for the use of the packaging;
  - (e) if the package is designed to have a maximum normal operating pressure in excess of 100 kPa gauge, a specification of the materials of manufacture of the containment system, the samples to be taken, and the tests to be made;
  - (f) if the package is to be used for shipment after storage, a justification of considerations to ageing mechanisms in the safety analysis and within the proposed operating and maintenance instructions;
  - (g) where the proposed radioactive contents are irradiated nuclear fuel, a statement and a justification of any assumption in the safety analysis relating to the characteristics of the fuel and a description of any pre-shipment measurement required by 6.4.11.5(b);
  - (h) any special stowage provisions necessary to ensure the safe dissipation of heat from the package, considering the various modes of transport to be used and type of conveyance or freight container;
  - (i) a reproducible illustration, not larger than 21 cm by 30 cm, showing the make-up of the package;
  - (j) a specification of the applicable management system as required in 1.5.3.1; and
  - (k) for packages which are to be used for shipment after storage, a gap analysis programme describing a systematic procedure for a periodic evaluation of changes of regulations, changes in technical knowledge and changes of the state of the package design during storage.
- 6.4.23.5** An application for approval of a Type B(M) package design shall include, in addition to the information required in 6.4.23.4 for Type B(U) packages:
- (a) a list of the provisions specified in 6.4.7.5, 6.4.8.4 to 6.4.8.6 and 6.4.8.9 to 6.4.8.15 with which the package does not conform;
  - (b) any proposed supplementary operational controls to be applied during transport not regularly provided for in this Code, but which are necessary to ensure the safety of the package or to compensate for the deficiencies listed in (a) above;
  - (c) a statement relative to any restrictions on the mode of transport and to any special loading, carriage, unloading or handling procedures; and
  - (d) a statement of the range of ambient conditions (temperature, solar radiation) which are expected to be encountered during transport and which have been taken into account in the design.
- 6.4.23.6** The application for approval of designs for packages containing 0.1 kg or more of uranium hexafluoride shall include all information necessary to satisfy the competent authority that the design meets the provisions of 6.4.6.1, and a specification of the applicable management system as required in 1.5.3.1.
- 6.4.23.7** An application for a fissile package approval shall include all information necessary to satisfy the competent authority that the design meets the provisions of 6.4.11.1, and a specification of the applicable management system as required in 1.5.3.1.
- 6.4.23.8** An application for approval of design for special form radioactive material and design for low dispersible radioactive material shall include:
- (a) a detailed description of the radioactive material or, if a capsule, the contents; particular reference shall be made to both physical and chemical states;
  - (b) a detailed statement of the design of any capsule to be used;
  - (c) a statement of the tests which have been done and their results, or evidence based on calculations to show that the radioactive material is capable of meeting the performance standards, or other evidence

## Chapter 6.4 – Construction, testing and approval of packages for radioactive material

that the special form radioactive material or low dispersible radioactive material meets the applicable provisions of this Code;

- (d) a specification of the applicable management system as required in 1.5.3.1; and
- (e) any proposed pre-shipment actions for use in the consignment of special form radioactive material or low dispersible radioactive material.

**6.4.23.9** An application for approval of design for fissile material excepted from “FISSILE” classification in accordance with table 2.7.2.1.1, under 2.7.2.3.5.6 shall include:

- (a) a detailed description of the material; particular reference shall be made to both physical and chemical states;
- (b) a statement of the tests that have been carried out and their results, or evidence based on calculation methods to show that the material is capable of meeting the requirements specified in 2.7.2.3.6;
- (c) a specification of the applicable management system as required in 1.5.3.1;
- (d) a statement of specific actions to be taken prior to shipment.

**6.4.23.10** An application for approval of alternative activity limits for an exempt consignment of instruments or articles shall include:

- (a) an identification and detailed description of the instrument or article, its intended uses and the radionuclide(s) incorporated;
- (b) the maximum activity of the radionuclide(s) in the instrument or article;
- (c) maximum external dose rates arising from the instrument or article;
- (d) the chemical and physical forms of the radionuclide(s) contained in the instrument or article;
- (e) details of the construction and design of the instrument or article, particularly as related to the containment and shielding of the radionuclide in routine, normal and accident conditions of transport;
- (f) the applicable management system, including the quality testing and verification procedures to be applied to radioactive sources, components and finished products to ensure that the maximum specified activity of radioactive material or the maximum dose rates specified for the instrument or article are not exceeded, and that the instruments or articles are constructed according to the design specifications;
- (g) the maximum number of instruments or articles expected to be shipped per consignment and annually;
- (h) dose assessments in accordance with the principles and methodologies set out in the *Radiation Protection and Safety of Radiation Sources: International Basic Safety Standards, IAEA Safety Standards Series No. GSR Part 3, IAEA, Vienna (2014)*, including individual doses to transport workers and members of the public and, if appropriate, collective doses arising from routine, normal and accident conditions of transport, based on representative transport scenarios the consignments are subject to.

**6.4.23.11** Each certificate of approval issued by a competent authority shall be assigned an identification mark. The mark shall be of the following generalized type:

**VRI/number/type code**

- (a) Except as provided in 6.4.23.12(b), “VRI” represents the distinguishing sign used on vehicles in international road traffic\* of the country issuing the certificate.
- (b) The number shall be assigned by the competent authority, and shall be unique and specific with regard to the particular design or shipment or alternative activity limit for exempt consignment. The identification mark of the approval of shipment shall be clearly related to the identification mark of the approval of design.
- (c) The following type codes shall be used, in the order listed, to indicate the types of certificate of approval issued:

|      |   |
|------|---|
| AF   | Type A package design for fissile material                    |
| B(U) | Type B(U) package design (“B(U)F” if for fissile material)    |
| B(M) | Type B(M) package design (“B(M)F” if for fissile material)    |
| C    | Type C package design (“CF” if for fissile material)          |
| IF   | industrial package design for fissile material                |
| S    | special form radioactive material                             |
| LD   | low dispersible radioactive material                          |
| FE   | fissile material complying with the requirements of 2.7.2.3.6 |
| T    | shipment  |

\* Distinguishing sign of the State of registration used on motor vehicles and trailers in international road traffic, e.g. in accordance with the Geneva Convention on Road Traffic of 1949 or the Vienna Convention on Road Traffic of 1968.

**Part 6 – Construction and testing of packagings, IBCs, etc.**

- X special arrangement  
AL alternative activity limits for an exempt consignment of instruments or articles.

In the case of package designs for non-fissile or fissile-excepted uranium hexafluoride, where none of the above codes apply, then the following type codes shall be used:

- H(U) unilateral approval  
H(M) multilateral approval.

**6.4.23.12** These identification marks shall be applied as follows:

- (a) each certificate and each package shall bear the appropriate identification marks, comprising the symbols prescribed in 6.4.23.11(a), (b) and (c) above, except that, for packages, only the applicable design type codes shall appear following the second stroke; that is, the “T” or “X” shall not appear in the identification mark on the package. Where the approval of design and the approval of shipment are combined, the applicable type codes do not need to be repeated. For example:

**A/132/B(M)F**: a Type B(M) package design approved for fissile material, requiring multilateral approval, for which the competent authority of Austria has assigned the design number 132 (to be marked on both the package and on the certificate of approval for the package design);

**A/132/B(M)/FT**: the approval of shipment issued for a package bearing the identification mark elaborated above (to be marked on the certificate only);

**A/137/X**: an approval of special arrangement issued by the competent authority of Austria, to which the number 137 has been assigned (to be marked on the certificate only);

**A/139/IF**: an industrial package design for fissile material approved by the competent authority of Austria, to which package design number 139 has been assigned (to be marked on both the package and on the certificate of approval for the package design); and

**A/145/H(U)**: a package design for fissile-excepted uranium hexafluoride approved by the competent authority of Austria, to which package design number 145 has been assigned (to be marked on both the package and on the certificate of approval for the package design);

- (b) where multilateral approval is effected by validation in accordance with 6.4.23.20, only the identification mark issued by the country of origin of the design or shipment shall be used. Where multilateral approval is effected by issue of certificates by successive countries, each certificate shall bear the appropriate identification mark and the package whose design was so approved shall bear all appropriate identification marks. For example:

**A/132/B(M)F**  
**CH/28/B(M)F**

would be the identification mark of a package which was originally approved by Austria and was subsequently approved, by separate certificate, by Switzerland. Additional identification marks would be tabulated in a similar manner on the package;

- (c) the revision of a certificate shall be indicated by a parenthetical expression following the identification mark on the certificate. For example, **A/132/B(M)F (Rev.2)** would indicate revision 2 of the Austrian certificate of approval for the package design; or **A/132/B(M)/F (Rev.0)** would indicate the original issuance of the Austrian certificate of approval for the package design. For original issuances, the parenthetical entry is optional and other words such as ‘original issuance’ may also be used in place of ‘Rev.0’. Certificate revision numbers may only be issued by the country issuing the original certificate of approval;
- (d) additional symbols (as may be necessitated by national provisions) may be added in parentheses to the end of the identification mark. For example, **A/132/B(M)F (SP503)**; and
- (e) it is not necessary to alter the identification mark on the packaging each time that a revision to the design certificate is made. Such re-marking shall be required only in those cases where the revision to the package design certificate involves a change in the letter type codes for the package design following the second stroke.

**6.4.23.13** Each certificate of approval issued by a competent authority for special form radioactive material or low dispersible radioactive material shall include the following information:

- (a) Type of certificate.  
(b) The competent authority identification mark.  
(c) The issue date and an expiry date.  
(d) List of applicable national and international regulations, including the edition of the IAEA *Regulations for the Safe Transport of Radioactive Material* under which the special form radioactive material or low dispersible radioactive material is approved.  
(e) The identification of the special form radioactive material or low dispersible radioactive material.  
(f) A description of the special form radioactive material or low dispersible radioactive material.

## Chapter 6.4 – Construction, testing and approval of packages for radioactive material

- (g) Design specifications for the special form radioactive material or low dispersible radioactive material, which may include references to drawings.
- (h) A specification of the radioactive contents which includes the activities involved and which may include the physical and chemical form.
- (i) A specification of the applicable management system as required in 1.5.3.1.
- (j) Reference to information provided by the applicant relating to specific actions to be taken prior to shipment.
- (k) If deemed appropriate by the competent authority, reference to the identity of the applicant.
- (l) Signature and identification of the certifying official.

**6.4.23.14** Each certificate of approval issued by a competent authority for material excepted from classification as “FISSILE” shall include the following information:

- (a) Type of certificate.
- (b) The competent authority identification mark.
- (c) The issue date and an expiry date.
- (d) List of applicable national and international regulations, including the edition of the IAEA *Regulations for the Safe Transport of Radioactive Material* under which the exception is approved.
- (e) A description of the excepted material.
- (f) Limiting specifications for the excepted material.
- (g) A specification of the applicable management system as required in 1.5.3.1.
- (h) Reference to information provided by the applicant relating to specific actions to be taken prior to shipment.
- (i) If deemed appropriate by the competent authority, reference to the identity of the applicant.
- (j) Signature and identification of the certifying official.
- (k) Reference to documentation that demonstrates compliance with 2.7.2.3.6.

**6.4.23.15** Each certificate of approval issued by a competent authority for a special arrangement shall include the following information:

- (a) Type of certificate.
- (b) The competent authority identification mark.
- (c) The issue date and an expiry date.
- (d) Mode(s) of transport.
- (e) Any restrictions on the modes of transport, type of conveyance, freight container, and any necessary routing instructions.
- (f) List of applicable national and international regulations, including the edition of the IAEA *Regulations for the Safe Transport of Radioactive Material* under which the special arrangement is approved.
- (g) The following statement: “This certificate does not relieve the consignor from compliance with any requirement of the government of any country through or into which the package will be transported.”
- (h) References to certificates for alternative radioactive contents, other competent authority validation, or additional technical data or information, as deemed appropriate by the competent authority.
- (i) Description of the packaging by a reference to the drawings or a specification of the design. If deemed appropriate by the competent authority, a reproducible illustration, not larger than 21 cm by 30 cm, showing the make-up of the package shall also be provided, accompanied by a brief description of the packaging, including materials of manufacture, gross mass, general outside dimensions and appearance.
- (j) A specification of the authorized radioactive contents, including any restrictions on the radioactive contents which might not be obvious from the nature of the packaging. This shall include the physical and chemical forms, the activities involved (including those of the various isotopes, if appropriate), mass in grams (for fissile material or for each fissile nuclide when appropriate), and whether special form radioactive material, low dispersible radioactive material or fissile material excepted under 2.7.2.3.5.6, if applicable.
- (k) Additionally, for packages containing fissile material:
  - (i) a detailed description of the authorized radioactive contents;
  - (ii) the value of the criticality safety index;
  - (iii) reference to the documentation that demonstrates the criticality safety of the package;
  - (iv) any special features, on the basis of which the absence of water from certain void spaces has been assumed in the criticality assessment;



**Part 6 – Construction and testing of packagings, IBCs, etc.**

- (v) any allowance (based on 6.4.11.5(b)) for a change in neutron multiplication assumed in the criticality assessment as a result of actual irradiation experience; and
- (vi) the ambient temperature range for which the special arrangement has been approved.
- (l) A detailed listing of any supplementary operational controls required for preparation, loading, carriage, unloading and handling of the consignment, including any special stowage provisions for the safe dissipation of heat.
- (m) If deemed appropriate by the competent authority, reasons for the special arrangement.
- (n) Description of the compensatory measures to be applied as a result of the shipment being under special arrangement.
- (o) Reference to information provided by the applicant relating to the use of the packaging or specific actions to be taken prior to the shipment.
- (p) A statement regarding the ambient conditions assumed for purposes of design if these are not in accordance with those specified in 6.4.8.5, 6.4.8.6 and 6.4.8.15, as applicable.
- (q) Any emergency arrangements deemed necessary by the competent authority.
- (r) A specification of the applicable management system as required in 1.5.3.1.
- (s) If deemed appropriate by the competent authority, reference to the identity of the applicant and to the identity of the carrier.
- (t) Signature and identification of the certifying official.

**6.4.23.16** Each certificate of approval for a shipment issued by a competent authority shall include the following information:

- (a) Type of certificate.
- (b) The competent authority identification mark(s).
- (c) The issue date and an expiry date.
- (d) List of applicable national and international regulations, including the edition of the IAEA *Regulations for the Safe Transport of Radioactive Material* under which the shipment is approved.
- (e) Any restrictions on the modes of transport, type of conveyance, freight container, and any necessary routing instructions.
- (f) The following statement: “This certificate does not relieve the consignor from compliance with any requirement of the government of any country through or into which the package will be transported.”
- (g) A detailed listing of any supplementary operational controls required for preparation, loading, carriage, unloading and handling of the consignment, including any special stowage provisions for the safe dissipation of heat or maintenance of criticality safety.
- (h) Reference to information provided by the applicant relating to specific actions to be taken prior to shipment.
- (i) Reference to the applicable certificate(s) of approval of design.
- (j) A specification of the actual radioactive contents, including any restrictions on the radioactive contents which might not be obvious from the nature of the packaging. This shall include the physical and chemical forms, the total activities involved (including those of the various isotopes, if appropriate), mass in grams (for fissile material or for each fissile nuclide when appropriate), and whether special form radioactive material, low dispersible radioactive material or fissile material excepted under 2.7.2.3.5.6, if applicable.
- (k) Any emergency arrangements deemed necessary by the competent authority.
- (l) A specification of the applicable management system as required in 1.5.3.1.
- (m) If deemed appropriate by the competent authority, reference to the identity of the applicant.
- (n) Signature and identification of the certifying official.

**6.4.23.17** Each certificate of approval of the design of a package issued by a competent authority shall include the following information:

- (a) Type of certificate.
- (b) The competent authority identification mark.
- (c) The issue date and an expiry date.
- (d) Any restriction on the modes of transport, if appropriate.
- (e) List of applicable national and international regulations, including the edition of the IAEA *Regulations for the Safe Transport of Radioactive Material* under which the design is approved.
- (f) The following statement: “This certificate does not relieve the consignor from compliance with any requirement of the government of any country through or into which the package will be transported.”
- (g) References to certificates for alternative radioactive contents, other competent authority validation, or additional technical data or information, as deemed appropriate by the competent authority.

## Chapter 6.4 – Construction, testing and approval of packages for radioactive material

- (h) A statement authorizing shipment where approval of shipment is required under 5.1.5.1.2, if deemed appropriate.
- (i) Identification of the packaging.
- (j) Description of the packaging by a reference to the drawings or specification of the design. If deemed appropriate by the competent authority, a reproducible illustration, not larger than 21 cm by 30 cm, showing the make-up of the package shall also be provided, accompanied by a brief description of the packaging, including materials of manufacture, gross mass, general outside dimensions and appearance.
- (k) Specification of the design by reference to the drawings.
- (l) A specification of the authorized radioactive content, including any restrictions on the radioactive contents which might not be obvious from the nature of the packaging. This shall include the physical and chemical forms, the activities involved (including those of the various isotopes, if appropriate), mass in grams (for fissile material the total mass of fissile nuclides or the mass for each fissile nuclide, when appropriate) and whether special form radioactive material, low dispersible radioactive material or fissile material excepted under 2.7.2.3.5.6, if applicable.
- (m) A description of the containment system;
- (n) For package designs containing fissile material which require multilateral approval of the package design in accordance with 6.4.22.4:
  - (i) a detailed description of the authorized radioactive contents;
  - (ii) a description of the confinement system;
  - (iii) the value of the criticality safety index;
  - (iv) reference to the documentation that demonstrates the criticality safety of the package;
  - (v) any special features, on the basis of which the absence of water from certain void spaces has been assumed in the criticality assessment;
  - (vi) any allowance (based on 6.4.11.5(b)) for a change in neutron multiplication assumed in the criticality assessment as a result of actual irradiation experience; and
  - (vii) the ambient temperature range for which the package design has been approved.
- (o) For Type B(M) packages, a statement specifying those prescriptions of 6.4.7.5, 6.4.8.4, 6.4.8.5, 6.4.8.6 and 6.4.8.9–6.4.8.15 with which the package does not conform and any amplifying information which may be useful to other competent authorities.
- (p) For package designs subject to 6.4.24.2, a statement specifying those requirements of the current regulations with which the package does not conform.
- (q) For packages containing more than 0.1 kg of uranium hexafluoride, a statement specifying those prescriptions of 6.4.6.4 that apply, if any, and any amplifying information which may be useful to other competent authorities.
- (r) A detailed listing of any supplementary operational controls required for preparation, loading, carriage, unloading and handling of the consignment, including any special stowage provisions for the safe dissipation of heat.
- (s) Reference to information provided by the applicant relating to the use of the packaging or specific actions to be taken prior to shipment.
- (t) A statement regarding the ambient conditions assumed for purposes of design if these are not in accordance with those specified in 6.4.8.5, 6.4.8.6 and 6.4.8.15, as applicable.
- (u) A specification of the applicable management system as required in 1.5.3.1.
- (v) Any emergency arrangements deemed necessary by the competent authority.
- (w) If deemed appropriate by the competent authority, reference to the identity of the applicant.
- (x) Signature and identification of the certifying official.

**6.4.23.18** Each certificate issued by a competent authority for alternative activity limits for an exempt consignment of instruments or articles according to 5.1.5.2.1.4 shall include the following information:

- (a) Type of certificate.
- (b) The competent authority identification mark.
- (c) The issue date and an expiry date.
- (d) List of applicable national and international regulations, including the edition of the IAEA *Regulations for the Safe Transport of Radioactive Material* under which the exemption is approved.
- (e) The identification of the instrument or article.
- (f) A description of the instrument or article.
- (g) Design specifications for the instrument or article.
- (h) A specification of the radionuclide(s), the approved alternative activity limit(s) for the exempt consignment(s) of the instrument(s) or article(s).



**Part 6 – Construction and testing of packagings, IBCs, etc.**

- (i) Reference to documentation that demonstrates compliance with 2.7.2.2.2.2.
- (j) If deemed appropriate by the competent authority, reference to the identity of the applicant.
- (k) Signature and identification of the certifying official.

6.4.23.19 The competent authority shall be informed of the serial number of each packaging manufactured to a design approved under 6.4.22.2, 6.4.22.3, 6.4.22.4 and 6.4.24.2.

6.4.23.20 Multilateral approval may be by validation of the original certificate issued by the competent authority of the country of origin of the design or shipment. Such validation may take the form of an endorsement on the original certificate or the issuance of a separate endorsement, annex, supplement, etc., by the competent authority of the country through or into which the shipment is made.

**6.4.24 Transitional measures for class 7**

**Packages not requiring competent authority approval of design under the 1985, 1985 (as amended 1990), 1996, 1996 (revised), 1996 (as amended 2003), 2005, 2009 and 2012 editions of the IAEA Regulations for the Safe Transport of Radioactive Material**

6.4.24.1 Packages not requiring competent authority approval of design (excepted packages, Type IP-1, Type IP-2, Type IP-3 and Type A packages) shall meet the provisions of this Code in full, except that:

- (a) Packages that meet the requirements of the 1985 or 1985 (as amended 1990) editions of the *IAEA Regulations for the Safe Transport of Radioactive Material*:
  - (i) may continue in transport provided that they were prepared for transport prior to 31 December 2003 and are subject to the requirements of 6.4.24.5, if applicable; or
  - (ii) may continue to be used, provided that all the following conditions are met:
    - they were not designed to contain uranium hexafluoride;
    - the applicable requirements of 1.5.3.1 of this Code are applied;
    - the activity limits and classification in chapter 2.7 of this Code are applied;
    - the requirements and controls for transport in parts 1, 3, 4, 5 and 7 of this Code are applied; and
    - the packaging was not manufactured or modified after 31 December 2003;
- (b) Packages that meet the requirements of the 1996, 1996 (revised), 1996 (as amended 2003), 2005, 2009 or 2012 editions of the *IAEA Regulations for the Safe Transport of Radioactive Material*:
  - (i) may continue in transport provided that they were prepared for transport prior to 31 December 2025 and are subject to the requirements of 6.4.24.5, if applicable; or
  - (ii) may continue to be used, provided that all the following conditions are met:
    - The applicable requirements of 1.5.3.1 of this Code are applied;
    - The activity limits and classification in chapter 2.7 of this Code are applied;
    - The requirements and controls for transport in parts 1, 3, 4, 5 and 7 of this Code are applied; and
    - The packaging was not manufactured or modified after 31 December 2025.

**Package designs approved under the 1985, 1985 (as amended 1990), 1996, 1996 (revised), 1996 (as amended 2003), 2005, 2009 and 2012 editions of the IAEA Regulations for the Safe Transport of Radioactive Material**

6.4.24.2 Packages requiring competent authority approval of the design shall meet this Edition of this Code in full except that:

- (a) Packagings that were manufactured to a package design approved by the competent authority under the provisions of the 1985 or 1985 (as amended 1990) editions of the *IAEA Regulations for the Safe Transport of Radioactive Material* may continue to be used provided that all of the following conditions are met:
  - (i) the package design is subject to multilateral approval;
  - (ii) the applicable requirements of 1.5.3.1 of this Code are applied;
  - (iii) the activity limits and classification in chapter 2.7 of this Code are applied;
  - (iv) the requirements and controls for transport in parts 1, 3, 4, 5 and 7 of this Code are applied;
  - (v) for a package containing fissile material and transported by air, the requirement of 6.4.11.11 is met;
- (b) Packagings that were manufactured to a package design approved by the competent authority under the provisions of the 1996, 1996 (revised), 1996 (as amended 2003), 2005, 2009 or 2012 editions of the *IAEA Regulations for the Safe Transport of Radioactive Material* may continue to be used provided that all of the following conditions are met:
  - (i) the package design is subject to multilateral approval after 31 December 2025;
  - (ii) the applicable requirements of 1.5.3.1 of this Code are applied;

## Chapter 6.4 – Construction, testing and approval of packages for radioactive material

- (iii) the activity limits and material restrictions of chapter 2.7 of this Code are applied;
- (iv) the requirements and controls for transport in parts 1, 3, 4, 5 and 7 of this Code are applied.

6.4.24.3 No new manufacture of packagings to a package design meeting the provisions of the 1985, or 1985 (as amended 1990) editions of the IAEA *Regulations for the Safe Transport of Radioactive Material* shall be permitted to commence.

6.4.24.4 No new manufacture of packagings of a package design meeting the provisions of the 1996, 1996 (revised), 1996 (as amended 2003), 2005, 2009 or 2012 editions of the IAEA *Regulations for the Safe Transport of Radioactive Material* shall be permitted to commence after 31 December 2028.

**Packages excepted from the requirements for fissile materials under the Regulations annexed to the 16th revised edition or the 17th revised edition of the United Nations Recommendations on the Transport of Dangerous Goods (2009 edition of the IAEA Regulations for the Safe Transport of Radioactive Material)**

6.4.24.5 Packages containing fissile material that is excepted from classification as “FISSILE” according to 2.7.2.3.5.1(i) or (iii) of the IMDG Code Amendments 35-10 or 36-12 (paragraphs 417(a)(i) or (iii) of the 2009 edition of the IAEA *Regulations for the Safe Transport of Radioactive Material*) prepared for transport before 31 December 2014 may continue in transport and may continue to be classified as non-fissile or fissile-excepted except that the consignment limits in table 2.7.2.3.5 of these editions shall apply to the conveyance. The consignment shall be transported under exclusive use.

**Special form radioactive material approved under the 1985, 1985 (as amended 1990), 1996, 1996 (revised), 1996 (as amended 2003), 2005, 2009 and 2012 editions of the IAEA Regulations for the Safe Transport of Radioactive Material**

6.4.24.6 Special form radioactive material manufactured to a design which had received unilateral approval by the competent authority under the 1985, 1985 (as amended 1990), 1996, 1996 (revised), 1996 (as amended 2003), 2005, 2009 or 2012 editions of the IAEA *Regulations for the Safe Transport of Radioactive Material* may continue to be used when in compliance with the mandatory management system in accordance with the applicable requirements of 1.5.3.1. There shall be no new manufacture of special form radioactive material to a design that had received unilateral approval by the competent authority under the 1985 or 1985 (as amended 1990) editions of the IAEA *Regulations for the Safe Transport of Radioactive Material*. No new manufacture of special form radioactive material to a design that had received unilateral approval by the competent authority under the 1996, 1996 (revised), 1996 (as amended 2003), 2005, 2009 or 2012 editions of the IAEA *Regulations for the Safe Transport of Radioactive Material* shall be permitted to commence after 31 December 2025.

## Chapter 6.5

### *Provisions for the construction and testing of intermediate bulk containers (IBCs)*

#### 6.5.1 General requirements

##### 6.5.1.1 Scope

6.5.1.1.1 The provisions of this chapter apply to IBCs intended for the transport of certain dangerous substances and materials.

6.5.1.1.2 The requirements for IBCs in 6.5.3 are based on IBCs currently in use. In order to take into account progress in science and technology, there is no objection to the use of IBCs having specifications different from those in 6.5.3 and 6.5.5, provided that they are equally effective, acceptable to the competent authority and able to successfully fulfil the requirements described in 6.5.4 and 6.5.6. Methods of inspection and testing other than those described in this Code are acceptable, provided they are equivalent.

6.5.1.1.3 The construction, equipment, testing, marking and operation of IBCs shall be subject to acceptance by the competent authority of the country in which the IBCs are approved.

6.5.1.1.4 Manufacturers and subsequent distributors of IBCs shall provide information regarding procedures to be followed and a description of the types and dimensions of closures (including required gaskets) and any other components needed to ensure that IBCs as presented for transport are capable of passing the applicable performance tests of this chapter.

##### 6.5.1.2 Definitions

*Body* (for all categories of IBCs other than composite IBCs) means the receptacle proper, including openings and their closures, but does not include service equipment.

*Handling device* (for flexible IBCs) means any sling, loop, eye or frame attached to the body of the IBC or formed from a continuation of the IBC body material.

*Maximum permissible gross mass* means the mass of the IBC and any service or structural equipment together with the maximum net mass.

*Plastics material*, when used in connection with inner receptacles for composite IBCs, is taken to include other polymeric materials such as rubber.

*Protected* (for metal IBCs) means the IBC being provided with additional protection against impact, the protection taking the form of, for example, a multi-layer (sandwich) or double-wall construction or a frame with a metal latticework packaging.

*Service equipment* means filling and discharge devices and, according to the category of IBC, pressure relief or venting, safety, heating and heat-insulating devices and measuring instruments.

*Structural equipment* (for all categories of IBCs other than flexible IBCs) means the reinforcing, fastening, handling, protective or stabilizing members of the body, including the base pallet for composite IBCs with plastics inner receptacle, fibreboard and wooden IBCs.

*Woven plastics* (for flexible IBCs) means a material made from stretched tapes or monofilaments of a suitable plastics material.

##### 6.5.1.3 Categories of IBCs

6.5.1.3.1 *Metal* IBCs consist of a metal body together with appropriate service and structural equipment.

6.5.1.3.2 *Flexible* IBCs consist of a body constituted of film, woven fabric or any other flexible material or combinations thereof, and if necessary an inner coating or liner, together with any appropriate service equipment and handling devices.

6.5.1.3.3 *Rigid plastics* IBCs consist of a rigid plastics body, which may have structural equipment together with appropriate service equipment.

Chapter 6.5 – Construction and testing of intermediate bulk containers (IBCs)

- 6.5.1.3.4 *Composite* IBCs consist of structural equipment in the form of a rigid outer packaging enclosing a plastics inner receptacle together with any service or other structural equipment. The IBC is so constructed that the inner receptacle and outer packaging, once assembled, form, and are used as, an integrated single unit to be filled, stored, transported or emptied as such.
- 6.5.1.3.5 *Fibreboard* IBCs consist of a fibreboard body with or without separate top and bottom caps, if necessary, an inner liner (but no inner packagings) and appropriate service and structural equipment.
- 6.5.1.3.6 *Wooden* IBCs consist of a rigid or collapsible wooden body together with an inner liner (but no inner packagings) and appropriate service and structural equipment.

6.5.1.4 Designatory code system for IBCs

6.5.1.4.1 The code shall consist of two Arabic numerals as specified in .1 followed by one or more capital letters as specified in .2; followed, when specified in an individual section, by an Arabic numeral indicating the category of IBC.

.1

| Type     | For solids, filled or discharged |  | For liquids |
|----------|----------------------------------|--|-------------|
|          | by gravity                       | under pressure of more than 10 kPa (0.1 bar) |             |
| Rigid    | 11                               | 21   | 31          |
| Flexible | 13                               | –  | –           |

.2 Materials

- A Steel (all types and surface treatments)
- B Aluminium
- C Natural wood
- D Plywood
- F Reconstituted wood
- G Fibreboard
- H Plastics material
- L Textile
- M Paper, multiwall
- N Metal (other than steel or aluminium)

6.5.1.4.2 For a composite IBC, two capital letters in Latin characters shall be used in sequence in the second position of the code. The first shall indicate the material of the inner receptacle of the IBC and the second that of the outer packaging of the IBC.

6.5.1.4.3 The following types and codes of IBCs are assigned:

| Material                        | Category   | Code                                 | Paragraph |
|---------------------------------|--|--------------------------------------|-----------|
| <i>Metal</i>                    |  |                                      |           |
| A Steel                         | for solids, filled or discharged by gravity<br>for solids, filled or discharged under pressure<br>for liquids  | 11A<br>21A<br>31A                    | 6.5.5.1   |
| B Aluminium                     | for solids, filled or discharged by gravity<br>for solids, filled or discharged under pressure<br>for liquids  | 11B<br>21B<br>31B                    |           |
| N Other than steel or aluminium | for solids, filled or discharged by gravity<br>for solids, filled or discharged under pressure<br>for liquids  | 11N<br>21N<br>31N                    |           |
| <i>Flexible</i>                 |  |                                      |           |
| H Plastics                      | woven plastics without coating or liner<br>woven plastics, coated<br>woven plastics with liner<br>woven plastics, coated and with liner<br>plastics film | 13H1<br>13H2<br>13H3<br>13H4<br>13H5 | 6.5.5.2   |
| L Textile                       | without coating or liner<br>coated<br>with liner<br>coated and with liner  | 13L1<br>13L2<br>13L3<br>13L4         |           |



Part 6 – Construction and testing of packagings, IBCs, etc.

| Material                                     | Category  | Code   | Paragraph |
|--|---|--|-----------|
| <i>Flexible</i> (continued)<br>M Paper       | multiwall<br>multiwall, water-resistant   | 13M1<br>13M2                                       | 6.5.5.2   |
| H Rigid plastics                             | for solids, filled or discharged by gravity, fitted with structural equipment<br>for solids, filled or discharged by gravity, freestanding<br>for solids, filled or discharged under pressure, fitted with structural equipment<br>for solids, filled or discharged under pressure, freestanding<br>for liquids, fitted with structural equipment<br>for liquids, freestanding  | 11H1<br>11H2<br>21H1<br>21H2<br>31H1<br>31H2       | 6.5.5.3   |
| HZ Composite with plastics inner receptacle* | for solids, filled or discharged by gravity, with rigid plastics inner receptacle<br>for solids, filled or discharged by gravity, with flexible plastics inner receptacle<br>for solids, filled or discharged under pressure, with rigid plastics inner receptacle<br>for solids, filled or discharged under pressure, with flexible plastics inner receptacle<br>for liquids, with rigid plastics inner receptacle<br>for liquids, with flexible plastics inner receptacle | 11HZ1<br>11HZ2<br>21HZ1<br>21HZ2<br>31HZ1<br>31HZ2 | 6.5.5.4   |
| G Fibreboard                                 | for solids, filled or discharged by gravity   | 11G  | 6.5.5.5   |
| <i>Wooden</i><br>C Natural wood              | for solids, filled or discharged by gravity, with inner liner   | 11C  | 6.5.5.6   |
| D Plywood                                    | for solids, filled or discharged by gravity, with inner liner   | 11D  |           |
| F Reconstituted wood                         | for solids, filled or discharged by gravity, with inner liner   | 11F  |           |

\* The code shall be completed by replacing the letter 'Z' by a capital letter in accordance with 6.5.1.4.1.2 to indicate the nature of the material used for the outer packaging.

6.5.1.4.4 The letter 'W' may follow the IBC code. The letter 'W' signifies that the IBC, although of the same type as indicated by the code, is manufactured to a specification different from those in section 6.5.3 and is considered equivalent in accordance with the provisions in 6.5.1.1.2.

## 6.5.2 Marking

### 6.5.2.1 Primary marking

6.5.2.1.1 Each IBC manufactured and intended for use according to these provisions shall bear durable marks which are legible and placed in a location so as to be readily visible. Letters, numbers and symbols shall be at least 12 mm high and shall show:

- .1 the United Nations packaging symbol: 

This symbol shall not be used for any purpose other than certifying that a packaging, a flexible bulk container, a portable tank or a MEGC complies with the relevant requirements in chapters 6.1, 6.2, 6.3, 6.5, 6.6, 6.7 or 6.9. For metal IBCs on which the mark is stamped or embossed, the capital letters "UN" may be applied instead of the symbol;

- .2 the code designating the type of IBC according to 6.5.1.4;
- .3 a capital letter designating the packing group(s) for which the design type has been approved:  
 "X" for packing groups I, II and III (IBCs for solids only);  
 "Y" for packing groups II and III; or  
 "Z" for packing group III only;
- .4 the month and year (last two digits) of manufacture;
- .5 the State authorizing the allocation of the marks, indicated by the distinguishing sign used on vehicles in international road traffic;\*

\* Distinguishing sign of the State of registration used on motor vehicles and trailers in international road traffic, e.g. in accordance with the Geneva Convention on Road Traffic of 1949 or the Vienna Convention on Road Traffic of 1968.

Chapter 6.5 – Construction and testing of intermediate bulk containers (IBCs)





- .6 the name or symbol of the manufacturer and other identifications of the IBC as specified by the competent authority;
- .7 the stacking test load in kilograms. For IBCs not designed for stacking, the figure “0” shall be shown;
- .8 the maximum permissible gross mass in kilograms.

The primary marks required above shall be applied in the sequence of the subparagraphs above. The marks required by 6.5.2.2 and any further mark authorized by a competent authority shall still enable the primary marks to be correctly identified.

Each mark applied in accordance with .1 to .8 and with 6.5.2.2 shall be clearly separated, e.g. by a slash or space, so as to be easily identifiable.

6.5.2.1.2 IBCs manufactured from recycled plastics material as defined in 1.2.1 shall be marked “REC”. For rigid IBCs, this mark shall be placed near the marks prescribed in 6.5.2.1.1. For the inner receptacle of composite IBCs, this mark shall be placed near the marks prescribed in 6.5.2.2.4.

6.5.2.1.3 Examples of marks for various types of IBCs in accordance with .1 to .8 above:

|   |  |   |
|---|--|---|
|    | 11A/Y/02 99/<br>NL/...* 007/<br>5500/1500    | For a metal IBC for solids discharged by gravity and made from steel/ for packing groups II and III/ manufactured in February 1999/ authorized by the Netherlands/ manufactured by . . . *(name of manufacturer) and of a design type to which the competent authority has allocated serial number 007/ the stacking test load in kilograms/ and the maximum permissible gross mass in kilograms. |
|  | 13H3/Z/03 01/<br>F/...* 1713/<br>0/1500      | For a flexible IBC for solids discharged by gravity and made from woven plastics with a liner/ not designed to be stacked.  |
|  | 31H1/Y/04 99/<br>GB/...* 9099/<br>10800/1200 | For a rigid plastics IBC for liquids made from plastics with structural equipment withstanding the stack load.  |
|  | 31HA1/Y/05 01/<br>D/...* 1683/<br>10800/1200 | For a composite IBC for liquids with a rigid plastics inner receptacle and steel outer packaging.   |
|  | 11C/X/01 02/<br>S/...* 9876/<br>3000/910     | For a wooden IBC for solids with an inner liner and authorized for packing group I solids.  |
|  | 11G/Z/06 02/<br>I/...* 962/<br>0/500         | For a fibreboard IBC/ not designed to be stacked.   |
|  | 11D/Y/07 02/<br>E/...* 261/<br>3240/600      | For a plywood IBC with inner liner.   |

6.5.2.1.4 Where an IBC conforms to one or more than one tested IBC design type, including one or more than one tested packaging or large packaging design type, the IBC may bear more than one mark to indicate the relevant performance test requirements that have been met. Where more than one mark appears on an IBC, the marks shall appear in close proximity to one another and each mark shall appear in its entirety.

Part 6 – Construction and testing of packagings, IBCs, etc.

6.5.2.2 Additional marking

6.5.2.2.1 Each IBC shall bear the marks required in 6.5.2.1 and, in addition, the following information, which may appear on a corrosion-resistant plate permanently attached in a place readily accessible for inspection:

**Note:** For metal IBCs, this plate shall be a corrosion-resistant metal plate.

| Additional marks   | Category of IBC |                |           |            |        |
|--|-----------------|----------------|-----------|------------|--------|
|  | Metal           | Rigid plastics | Composite | Fibreboard | Wooden |
| Capacity in litres <sup>a</sup> at 20°C                                      | X               | X              | X         |            |        |
| Tare mass in kg <sup>a</sup>   | X               | X              | X         | X          | X      |
| Test (gauge) pressure, in kPa or bar, <sup>a</sup> if applicable             |                 | X              | X         |            |        |
| Maximum filling/discharge pressure in kPa or bar, <sup>a</sup> if applicable | X               | X              | X         |            |        |
| Body material and its minimum thickness in mm                                | X               |                |           |            |        |
| Date of last leakproofness test, if applicable (month and year)              | X               | X              | X         |            |        |
| Date of last inspection (month and year)                                     | X               | X              | X         |            |        |
| Serial number of the manufacturer  | X               |                |           |            |        |

<sup>a</sup> The unit used shall be indicated.

6.5.2.2.2 The maximum permitted stacking load applicable shall be displayed on a symbol as shown in the figures below. The symbol shall be durable and clearly visible.

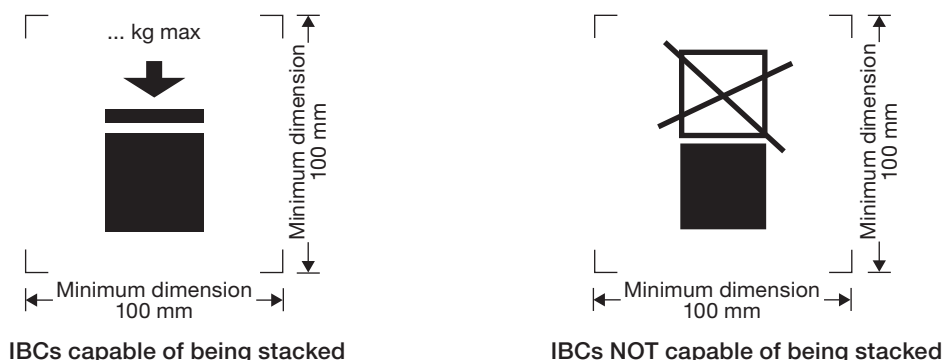

The minimum dimensions shall be 100 mm x 100 mm. The letters and numbers indicating the mass shall be at least 12 mm high. The area within the printer's marks indicated by the dimensional arrows shall be square. Where dimensions are not specified, all features shall be in approximate proportion to those shown. The mass marked above the symbol shall not exceed the load imposed during the design type test (see 6.5.6.6.4) divided by 1.8.

**Note:** The provisions of 6.5.2.2.2 shall apply to all IBCs manufactured, repaired or remanufactured as from 1 January 2011. The provisions of 6.5.2.2.2 of the IMDG Code (amendment 36-12) may continue to be applied to all IBCs manufactured, repaired or remanufactured between 1 January 2011 and 31 December 2016.

6.5.2.2.3 Each flexible IBC may also bear a pictogram or pictograms indicating the recommended lifting methods.

6.5.2.2.4 Inner receptacles that are of composite IBC design type shall be identified by the application of the marks indicated in 6.5.2.1.1.2, .3, .4 where this date is that of the manufacture of the plastics inner receptacle, .5 and .6. The UN packaging symbol shall not be applied. The marks shall be applied in the sequence shown in 6.5.2.1.1. They shall be durable, legible and placed in a location so as to be readily accessible for inspection after assembling the inner receptacle in the outer casing. When the marks on the inner receptacle are not readily accessible for inspection due to the design of the outer casing, a duplicate of the required marks on the inner receptacle shall be placed on the outer casing preceded by the wording "Inner receptacle". This duplicate shall be durable, legible and placed in a location so as to be readily accessible for inspection.



## Chapter 6.5 – Construction and testing of intermediate bulk containers (IBCs)

The date of the manufacture of the plastics inner receptacle may alternatively be marked on the inner receptacle adjacent to the remainder of the marks. In such a case, the date may be waived from the remainder of the marks. An example of an appropriate marking method is:

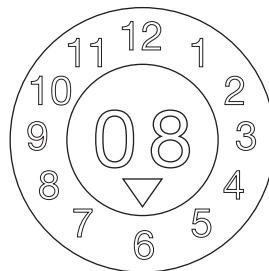

**Note 1:** Other methods that provide the minimum required information in a durable, visible and legible form are also acceptable.

**Note 2:** The date of manufacture of the inner receptacle may be different from the marked date of manufacture (see 6.5.2.1), repair (see 6.5.4.5.3) or remanufacture (see 6.5.2.4) of the composite IBC.

6.5.2.2.5 Where a composite IBC is designed in such a manner that the outer packaging is intended to be dismantled for transport when empty (such as for return of the IBC for re-use to the original consignor), each of the parts intended to be detached when so dismantled shall be marked with the month and year of manufacture and the name or symbol of the manufacturer and other identification of the IBC as specified by the competent authority (see 6.5.2.1.1.6).

#### 6.5.2.3 Conformity to design type

The marks indicate that the IBCs correspond to a successfully tested design type and that the provisions referred to in the certificate have been met.

#### 6.5.2.4 Marking of remanufactured composite IBCs (31HZ1)

The marks specified in 6.5.2.1.1 and 6.5.2.2 shall be removed from the original IBC or made permanently illegible and new marks shall be applied to an IBC remanufactured in accordance with these provisions of this Code.

### 6.5.3 Construction requirements

#### 6.5.3.1 General requirements

6.5.3.1.1 IBCs shall be resistant to or adequately protected from deterioration due to the external environment.

6.5.3.1.2 IBCs shall be so constructed and closed that none of the contents can escape under normal conditions of transport, including the effects of vibration, or by changes in temperature, humidity or pressure.

6.5.3.1.3 IBCs and their closures shall be constructed of materials compatible with their contents, or be protected internally, so that they are not liable:

- .1 to be attacked by the contents so as to make their use dangerous;
- .2 to cause the contents to react or decompose, or form harmful or dangerous compounds with the IBCs.

6.5.3.1.4 Gaskets, where used, shall be made of materials not subject to attack by the contents of an IBC.

6.5.3.1.5 All service equipment shall be so positioned or protected as to minimize the risk of escape of the contents owing to damage during handling and transport.

6.5.3.1.6 IBCs, their attachments and their service and structural equipment shall be designed to withstand, without loss of contents, the internal pressure of the contents and the stresses of normal handling and transport. IBCs intended for stacking shall be designed for stacking. Any lifting or securing features of IBCs shall be of sufficient strength to withstand the normal conditions of handling and transport without gross distortion or failure and shall be so positioned that no undue stress is caused in any part of the IBC.

6.5.3.1.7 Where an IBC consists of a body within a framework, it shall be so constructed that:

- .1 the body does not chafe or rub against the framework so as to cause material damage to the body,
- .2 the body is retained within the framework at all times,
- .3 the items of equipment are fixed in such a way that they cannot be damaged if the connections between body and frame allow relative expansion or movement.

**Part 6 – Construction and testing of packagings, IBCs, etc.**

**6.5.3.1.8** Where a bottom discharge valve is fitted, it shall be capable of being made secure in the closed position and the whole discharge system shall be suitably protected from damage. Valves having lever closures shall be able to be secured against accidental opening and the open or closed position shall be readily apparent. For IBCs containing liquids, a secondary means of sealing the discharge aperture shall also be provided, such as by a blank flange or equivalent device.

**6.5.4 Testing, certification and inspection****6.5.4.1 Quality assurance**

IBCs shall be manufactured, remanufactured, repaired and tested under a quality assurance programme which satisfies the competent authority, in order to ensure that each manufactured, remanufactured or repaired IBC meets the provisions of this chapter.

**Note:** ISO 16106:2020, *Transport packages for dangerous goods – Dangerous goods packagings, intermediate bulk containers (IBCs) and large packagings – Guidelines for the application of ISO 9001*, provides acceptable guidance on procedures which may be followed.

**6.5.4.2 Test provisions**

IBCs shall be subjected to design type tests and, if applicable, to initial and periodic inspections and tests in accordance with 6.5.4.4.

**6.5.4.3 Certification**

In respect of each design type of IBC, a certificate and mark (as in 6.5.2) shall be issued attesting that the design type, including its equipment, meets the test provisions.

**6.5.4.4 Inspection and testing**

**Note:** See also 6.5.4.5 for tests and inspections on repaired IBCs.

**6.5.4.4.1** Every metal, rigid plastics and composite IBC shall be inspected to the satisfaction of the competent authority:

.1 before it is put into service (including after remanufactured), and thereafter at intervals not exceeding five years, with regard to:

- .1 conformity to the design type, including marks;
- .2 internal and external condition; and
- .3 proper functioning of service equipment.

Thermal insulation, if any, need be removed only to the extent necessary for a proper examination of the body of the IBC.

.2 at intervals of not more than two and a half years with regard to:

- .1 external condition; and
- .2 proper functioning of service equipment.

Thermal insulation, if any, need be removed only to the extent necessary for a proper examination of the body of the IBC.

Each IBC shall correspond in all respects to its design type.

**6.5.4.4.2** Every metal, rigid plastics and composite IBC for liquids, or for solids which are filled or discharged under pressure, shall undergo a suitable leakproofness test. This test is part of a quality assurance programme as stipulated in 6.5.4.1 which shows the capability of meeting the appropriate test level indicated in 6.5.6.7.3:

- (a) before it is first used for transport;
- (b) at intervals of not more than two and a half years.

For this test the IBC shall be fitted with the primary bottom closure. The inner receptacle of a composite IBC may be tested without the outer casing, provided the test results are not affected.

**6.5.4.4.3** A report of each inspection and test shall be kept by the owner of the IBC at least until the next inspection or test. The report shall include the results of the inspection and test and shall identify the party performing the inspection and test (see also the marking requirements in 6.5.2.2.1).

**6.5.4.4.4** The competent authority may at any time require proof, by tests in accordance with this chapter, that the IBCs meet the provisions of the design type tests.

## Chapter 6.5 – Construction and testing of intermediate bulk containers (IBCs)

**6.5.4.5 Repaired IBCs**

6.5.4.5.1 When an IBC is impaired as a result of impact (e.g. accident) or any other cause, it shall be repaired or otherwise maintained (see definition of “Routine maintenance of IBCs” in 1.2.1), so as to conform to the design type. The bodies of rigid plastics IBCs and the inner receptacles of composite IBCs that are impaired shall be replaced.

6.5.4.5.2 In addition to any other testing and inspection requirements in this Code, an IBC shall be subjected to the full testing and inspection requirements set out in 6.5.4.4, and the required reports shall be prepared, whenever it is repaired.

6.5.4.5.3 The party performing the tests and inspections after the repair shall durably mark the IBC near the manufacturer’s UN design type marks to show:

- .1 the State in which the tests and inspections were carried out;
- .2 the name or authorized symbol of the party performing the tests and inspections; and
- .3 the date (month, year) of the tests and inspections.

6.5.4.5.4 Tests and inspections performed in accordance with 6.5.4.5.2 may be considered to satisfy the requirements for the 2.5- and 5-year periodic tests and inspections.

**6.5.5 Specific provisions for IBCs****6.5.5.1 Specific provisions for metal IBCs**

6.5.5.1.1 These provisions apply to metal IBCs for the transport of liquids and solids. There are three categories of metal IBCs:

- .1 those for solids which are filled and discharged by gravity (11A, 11B, 11N);
- .2 those for solids which are filled and discharged at a gauge pressure greater than 10 kPa (21A, 21B, 21N); and
- .3 those for liquids (31A, 31B, 31N).

6.5.5.1.2 Bodies shall be made of suitable ductile metal in which the weldability has been fully demonstrated. Welds shall be skilfully made and afford complete safety. Low-temperature performance shall be taken into account when appropriate.

6.5.5.1.3 Care shall be taken to avoid damage by galvanic action due to the juxtaposition of dissimilar metals.

6.5.5.1.4 Aluminium IBCs intended for the transport of flammable liquids shall have no movable parts, such as covers, closures, etc., made of unprotected steel liable to rust, which might cause a dangerous reaction by coming into frictional or percussive contact with the aluminium.

6.5.5.1.5 Metal IBCs shall be made of metals which meet the following provisions:

- .1 For steel, the elongation at fracture, per cent, shall not be less than  $10,000/R_m$  with an absolute minimum of 20%, where  $R_m$  = guaranteed minimum tensile strength of the reference steel to be used, in N/mm<sup>2</sup>.
- .2 For aluminium and aluminium alloys, the elongation at fracture, per cent, shall not be less than  $10,000/6R_m$  with an absolute minimum of 8%.

Specimens used to determine the elongation at fracture shall be taken transversely to the direction of rolling and be so secured that:

$$L_o = 5d, \text{ or}$$

$$L_o = 5.65\sqrt{A}$$

where :

$L_o$  = gauge length of the specimen before the test;

$d$  = diameter; and

$A$  = cross-sectional area of the test specimen.

Part 6 – Construction and testing of packagings, IBCs, etc.

6.5.5.1.6 **Minimum wall thickness**

Metal IBCs with a capacity of more than 1,500 L shall comply with the following minimum wall thickness requirement:

- .1 For a reference steel having a product of  $R_m \times A_o = 10,000$ , the wall thickness shall not be less than:

| Wall thickness ( $T$ ) in mm |                     |                                    |                     |
|------------------------------|---------------------|------------------------------------|---------------------|
| Types 11A, 11B, 11N          |                     | Types 21A, 21B, 21N, 31A, 31B, 31N |                     |
| Unprotected                  | Protected           | Unprotected                        | Protected           |
| $T = C/2,000 + 1.5$          | $T = C/2,000 + 1.0$ | $T = C/1,000 + 1.0$                | $T = C/2,000 + 1.5$ |

where:  $A_o$  = minimum elongation (as a percentage) of the reference steel to be used on fracture under tensile stress (see 6.5.5.1.5).

$C$  = the capacity in litres

- .2 For metals other than the reference steel described in .1, the minimum wall thickness is given by the following equivalence formula:

$$e_1 = \frac{21.4 \times e_0}{\sqrt[3]{R_{m1} \times A_1}}$$

where:

$e_1$  = required equivalent wall thickness of the metal to be used (in mm);

$e_0$  = required minimum wall thickness for the reference steel (in mm);

$R_{m1}$  = guaranteed minimum tensile strength of the metal to be used (in  $N/mm^2$ ) (see .3); and

$A_1$  = minimum elongation (as a percentage) of the metal to be used on fracture under tensile stress (see 6.5.5.1.5).

However, in no case shall the wall thickness be less than 1.5 mm.

- .3 For purposes of the calculation described in .2, the guaranteed minimum tensile strength of the metal to be used ( $R_{m1}$ ) shall be the minimum value according to national or international material standards.

However, for austenitic steels, the specified minimum value for  $R_m$  according to the material standards may be increased by up to 15% when a greater value is attested in the material inspection certificate. When no material standard exists for the material in question, the value of  $R_m$  shall be the minimum value attested in the material inspection certificate.

6.5.5.1.7 **Pressure relief provisions**

IBCs for liquids shall be capable of releasing a sufficient amount of vapour in the event of fire engulfment to ensure that no rupture of the shell will occur. This can be achieved by conventional pressure relief devices or by other constructional means. The start-to-discharge pressure shall not be higher than 65 kPa and no lower than the total gauge pressure experienced in the IBC (i.e. the vapour pressure of the filling substance plus the partial pressure of the air or other inert gases, minus 100 kPa) at 55°C, determined on the basis of a maximum degree of filling as defined in 4.1.1.4. The pressure relief devices shall be fitted in the vapour space.

6.5.5.2 **Specific provisions for flexible IBCs**

- 6.5.5.2.1 These provisions apply to flexible IBCs of the following types:

- 13H1 woven plastics without coating or liner
- 13H2 woven plastics, coated
- 13H3 woven plastics with liner
- 13H4 woven plastics, coated and with liner
- 13H5 plastics film
- 13L1 textile without coating or liner
- 13L2 textile, coated
- 13L3 textile with liner
- 13L4 textile, coated and with liner
- 13M1 paper, multiwall
- 13M2 paper, multiwall, water-resistant.

Flexible IBCs are intended for the transport of solids only.

- 6.5.5.2.2 Bodies of IBCs shall be manufactured from suitable materials. The strength of the material and the construction of a flexible IBC shall be appropriate to its capacity and its intended use.



## Chapter 6.5 – Construction and testing of intermediate bulk containers (IBCs)

- 6.5.5.2.3 All materials used in the construction of flexible IBCs of types 13M1 and 13M2 shall, after complete immersion in water for not less than 24 hours, retain at least 85% of the tensile strength as measured originally on the material conditioned to equilibrium at 67% relative humidity or less.
- 6.5.5.2.4 Seams of IBCs shall be formed by stitching, heat sealing, gluing or any equivalent method. All stitched seam-ends shall be secured.
- 6.5.5.2.5 Flexible IBCs shall provide adequate resistance to ageing and to degradation caused by ultraviolet radiation, by climatic conditions, or by the substance contained within which would thereby render them unsuitable for their intended use.
- 6.5.5.2.6 For plastics flexible IBCs where protection against ultraviolet radiation is required, it shall be provided by the addition of carbon black or other suitable pigments or inhibitors. These additives shall be compatible with the contents and remain effective throughout the life of the body of the IBC. Where use is made of carbon black, pigments or inhibitors other than those used in the manufacture of the tested design type, retesting may be waived if changes in the carbon black content, the pigment content or the inhibitor content do not adversely affect the physical properties of the material of construction.
- 6.5.5.2.7 Additives may be incorporated into the material of the body to improve the resistance to ageing or to serve other purposes, provided that these do not adversely affect the physical or chemical properties of the material.
- 6.5.5.2.8 No material recovered from used receptacles shall be used in the manufacture of IBC bodies. Production residues or scrap from the same manufacturing process may, however, be used. Component parts such as fittings and pallet bases may also be used provided such components have not in any way been damaged in previous use.
- 6.5.5.2.9 When filled, the ratio of height to width shall be not more than 2:1.
- 6.5.5.2.10 The liner shall be made of a suitable material. The strength of the material used and the construction of the liner shall be appropriate to the capacity of the IBC and the intended use. Joints and closures shall be sift-proof and capable of withstanding pressures and impacts liable to occur under normal conditions of handling and transport.
- 6.5.5.3 Specific provisions for rigid plastics IBCs**
- 6.5.5.3.1 These provisions apply to rigid plastics IBCs for the transport of solids or liquids. Rigid plastics IBCs are of the following types:
- |      |   |
|------|---|
| 11H1 | fitted with structural equipment designed to withstand the whole load when IBCs are stacked, for solids which are filled or discharged by gravity     |
| 11H2 | freestanding, for solids which are filled or discharged by gravity  |
| 21H1 | fitted with structural equipment designed to withstand the whole load when IBCs are stacked, for solids which are filled or discharged under pressure |
| 21H2 | freestanding, for solids which are filled or discharged under pressure  |
| 31H1 | fitted with structural equipment designed to withstand the whole load when IBCs are stacked, for liquids  |
| 31H2 | freestanding, for liquids.  |
- 6.5.5.3.2 The body shall be manufactured from suitable plastics material of known specifications and be of adequate strength in relation to its capacity and to the service it is required to perform. Except for recycled plastics material as defined in 1.2.1, no used material other than production residues or regrind from the same manufacturing process may be used. The material shall be adequately resistant to ageing and to degradation caused by the substance contained within or, where relevant, by ultraviolet radiation. Low-temperature performance shall be taken into account when appropriate. Any permeation of the substance contained within shall not constitute a danger under normal conditions of transport.
- 6.5.5.3.3 Where protection against ultraviolet radiation is required, it shall be provided by the addition of carbon black or other suitable pigments or inhibitors. These additives shall be compatible with the contents and remain effective throughout the life of the body of the IBC. Where use is made of carbon black, pigments or inhibitors other than those used in the manufacture of the tested design type, retesting may be waived if changes in the carbon black content, the pigment content or the inhibitor content do not adversely affect the physical properties of the material of construction.
- 6.5.5.3.4 Additives may be incorporated in the material of the body to improve the resistance to ageing or to serve other purposes, provided that these do not adversely affect the physical or chemical properties of the material.

**Part 6 – Construction and testing of packagings, IBCs, etc.****6.5.5.4 Specific provisions for composite IBCs with plastics inner receptacles**

6.5.5.4.1 These provisions apply to composite IBCs for the transport of solids or liquids of the following types:

- 11HZ1 composite IBCs with a rigid plastics inner receptacle, for solids filled or discharged by gravity
- 11HZ2 composite IBCs with a flexible plastics inner receptacle, for solids filled or discharged by gravity
- 21HZ1 composite IBCs with a rigid plastics inner receptacle, for solids filled or discharged under pressure
- 21HZ2 composite IBCs with a flexible plastics inner receptacle, for solids filled or discharged under pressure
- 31HZ1 composite IBCs with a rigid plastics inner receptacle, for liquids
- 31HZ2 composite IBCs with a flexible plastics inner receptacle, for liquids.

This code shall be completed by replacing the letter 'Z' by a capital letter in accordance with 6.5.1.4.1.2 to indicate the nature of the material used for the outer packaging.

6.5.5.4.2 The inner receptacle is not intended to perform a containment function without its outer packaging. A "rigid" inner receptacle is a receptacle which retains its general shape when empty without closures in place and without the benefit of the outer packaging. Any inner receptacle that is not "rigid" is considered to be "flexible".

6.5.5.4.3 The outer packaging normally consists of rigid material formed so as to protect the inner receptacle from physical damage during handling and transport, but is not intended to perform the containment function. It includes the base pallet where appropriate.

6.5.5.4.4 A composite IBC with a fully enclosing outer packaging shall be so designed that the integrity of the inner receptacle may be readily assessed following the leakproofness and hydraulic tests.

6.5.5.4.5 IBCs of type 31HZ2 shall be limited to a capacity of not more than 1,250 L.

6.5.5.4.6 The inner receptacle shall be manufactured from suitable plastics material of known specifications and be of adequate strength in relation to its capacity and to the service it is required to perform. Except for recycled plastics material as defined in 1.2.1, no used material other than production residues or regrind from the same manufacturing process may be used. The material shall be adequately resistant to ageing and to degradation caused by the substance contained and, where relevant, by ultraviolet radiation. Low-temperature performance shall be taken into account when appropriate. Any permeation of the substance contained shall not constitute a danger under normal conditions of transport.

6.5.5.4.7 Where protection against ultraviolet radiation is required, it shall be provided by the addition of carbon black or other suitable pigments or inhibitors. These additives shall be compatible with the contents and remain effective throughout the life of the inner receptacle. Where use is made of carbon black, pigments or inhibitors other than those used in the manufacture of the tested design type, re-testing may be waived if changes in carbon black content, the pigment content or the inhibitor content do not adversely affect the physical properties of the material of construction.

6.5.5.4.8 Additives may be incorporated in the material of the inner receptacle to improve the resistance to ageing or to serve other purposes, provided that these do not adversely affect the physical or chemical properties of the material.

6.5.5.4.9 The inner receptacle of IBCs of type 31HZ2 shall consist of at least three plies of film.

6.5.5.4.10 The strength of the material and the construction of the outer packaging shall be appropriate to the capacity of the composite IBC and its intended use.

6.5.5.4.11 The outer packaging shall be free of any projection that might damage the inner receptacle.

6.5.5.4.12 Outer packagings of steel or aluminium shall be constructed of a suitable metal of adequate thickness.

6.5.5.4.13 Outer packagings of natural wood shall be of well-seasoned wood, commercially dry and free from defects that would materially lessen the strength of any part of the packaging. The tops and bottoms may be made of water-resistant reconstituted wood such as hardboard, particle board or other suitable type.

6.5.5.4.14 Outer packagings of plywood shall be made of well-seasoned rotary-cut, sliced or sawn veneer plywood, commercially dry and free from defects that would materially lessen the strength of the packaging. All adjacent plies shall be glued with water-resistant adhesive. Other suitable materials may be used in conjunction with plywood for the construction of packagings. Packagings shall be firmly nailed or secured to corner posts or ends or be assembled by equally suitable devices.

6.5.5.4.15 The walls of outer packagings of reconstituted wood shall be made of water-resistant reconstituted wood such as hardboard, particle board or other suitable type. Other parts of the packagings may be made of other suitable material.



## Chapter 6.5 – Construction and testing of intermediate bulk containers (IBCs)

- △ 6.5.5.4.16 For fibreboard outer packagings, strong and good-quality solid or double-faced corrugated fibreboard (single or multiwall) shall be used appropriate to the capacity of the packaging and to its intended use. The water resistance of the outer surface shall be such that the increase in mass, as determined in a test carried out over 30 minutes by the Cobb method of determining water absorption, is not greater than 155 g/m<sup>2</sup> – see ISO 535:2014. It shall have proper bending qualities. Fibreboard shall be cut, creased without scoring, and slotted so as to permit assembly without cracking, surface breaks or undue bending. The fluting of corrugated fibreboard shall be firmly glued by water-resistant adhesive to the facings.
- 6.5.5.4.17 The ends of fibreboard outer packagings may have a wooden frame or be entirely of wood. Reinforcements of wooden battens may be used.
- 6.5.5.4.18 Manufacturing joins in the fibreboard outer packagings shall be taped, lapped and glued, or lapped and stitched with metal staples. Lapped joins shall have an appropriate overlap. Where closing is effected by gluing or taping, a water-resistant adhesive shall be used.
- 6.5.5.4.19 Where the outer packagings are of plastics material, the relevant provisions of 6.5.5.4.6 to 6.5.5.4.8 shall apply.
- 6.5.5.4.20 The outer packagings of IBCs of type 31HZ2 shall enclose the inner receptacle on all sides.
- 6.5.5.4.21 Any integral pallet base forming part of the IBC or a detachable pallet shall be suitable for mechanical handling with the IBC filled to its maximum permissible gross mass.
- 6.5.5.4.22 The pallet or integral base shall be designed so as to avoid any protrusion of the base of the IBC that might be liable to damage in handling.
- 6.5.5.4.23 The outer packagings shall be secured to a detachable pallet to ensure stability in handling and transport. Where a detachable pallet is used, its top surface shall be free from sharp protrusions that might damage the IBC.
- 6.5.5.4.24 Strengthening devices such as timber supports to increase stacking performance may be used but shall be external to the inner receptacle.
- 6.5.5.4.25 Where IBCs are intended for stacking, the bearing surfaces shall be such as to distribute the load in a safe manner. Such IBCs shall be designed so that the load is not supported by the inner receptacle.
- 6.5.5.5 Specific provisions for fibreboard IBCs**
- 6.5.5.5.1 These provisions apply to fibreboard IBCs for the transport of solids which are filled or discharged by gravity. Fibreboard IBCs are of the following type: 11G.
- 6.5.5.5.2 Fibreboard IBCs shall not incorporate top lifting devices.
- △ 6.5.5.5.3 The body shall be made of strong and good-quality solid or double-faced corrugated fibreboard (single or multiwall), appropriate to the capacity of the IBC and to its intended use. The water resistance of the outer surface shall be such that the increase in mass, as determined in a test carried out over a period of 30 minutes by the Cobb method of determining water absorption, is not greater than 155 g/m<sup>2</sup> – see ISO 535:2014. It shall have proper bending qualities. Fibreboard shall be cut, creased without scoring, and slotted so as to permit assembly without cracking, surface breaks or undue bending. The fluting of corrugated fibreboard shall be firmly glued to the facings.
- 6.5.5.5.4 The walls, including top and bottom, shall have a minimum puncture resistance of 15 J, measured according to ISO 3036:1975.
- 6.5.5.5.5 Manufacturing joins in the body of IBCs shall be made with an appropriate overlap and shall be taped, glued, stitched with metal staples or fastened by other means at least equally effective. Where joins are effected by gluing or taping, a water-resistant adhesive shall be used. Metal staples shall pass completely through all pieces to be fastened and be formed or protected so that any inner liner cannot be abraded or punctured by them.
- 6.5.5.5.6 The liner shall be made of suitable material. The strength of the material used and the construction of the liner shall be appropriate to the capacity of the IBC and its intended use. Joins and closures shall be sift-proof and capable of withstanding pressure and impacts liable to occur under normal conditions of handling and transport.
- 6.5.5.5.7 Any integral pallet base forming part of the IBC or any detachable pallet shall be suitable for mechanical handling with the IBC filled to its maximum permissible gross mass.
- 6.5.5.5.8 The pallet or integral base shall be designed so as to avoid any protrusion of the base of the IBC that might be liable to damage in handling.
- 6.5.5.5.9 The body shall be secured to any detachable pallet to ensure stability in handling and transport. Where a detachable pallet is used, its top surface shall be free from sharp protrusions that might damage the IBC.



*Part 6 – Construction and testing of packagings, IBCs, etc.*

- 6.5.5.5.10 Strengthening devices such as timber supports to increase stacking performance may be used but shall be external to the liner.
- 6.5.5.5.11 Where IBCs are intended for stacking, the bearing surface shall be such as to distribute the load in a safe manner.
- 6.5.5.6 Specific provisions for wooden IBCs**
- 6.5.5.6.1 These provisions apply to wooden IBCs for the transport of solids which are filled or discharged by gravity. Wooden IBCs are of the following types:
- 11C natural wood with inner liner
  - 11D plywood with inner liner
  - 11F reconstituted wood with inner liner.
- 6.5.5.6.2 Wooden IBCs shall not incorporate top lifting devices.
- 6.5.5.6.3 The strength of the materials used and the method of construction shall be appropriate to the capacity and intended use of the IBC.
- 6.5.5.6.4 Natural wood shall be well seasoned, commercially dry and free from defects that would materially lessen the strength of any part of the IBC. Each part of the IBC shall consist of one piece or be equivalent thereto. Parts are considered equivalent to one piece, when:
- a suitable method of glued assembly, as for instance Lindermann joint, tongue and groove joint, ship lap or rabbet joint is used; or
  - a butt joint with at least two corrugated metal fasteners at each joint is used; or
  - other methods at least equally effective are used.
- 6.5.5.6.5 Bodies of plywood shall be at least three-ply. It shall be made of well-seasoned rotary-cut, sliced or sawn veneer, commercially dry and free from defects that would materially lessen the strength of the body. All adjacent plies shall be glued with water-resistant adhesive. Other suitable materials may be used with plywood for the construction of the body.
- 6.5.5.6.6 Bodies of reconstituted wood shall be made of water-resistant reconstituted wood such as hardboard, particle board or other suitable type.
- 6.5.5.6.7 IBCs shall be firmly nailed or secured to corner posts or ends or be assembled by equally suitable devices.
- 6.5.5.6.8 The liner shall be made of a suitable material. The strength of the material used and the construction of the liner shall be appropriate to the capacity of the IBC and its intended use. Joins and closures shall be sift-proof and capable of withstanding pressure and impacts liable to occur under normal conditions of handling and transport.
- 6.5.5.6.9 Any integral pallet base forming part of the IBC or any detachable pallet shall be suitable for mechanical handling with the IBC filled to its maximum permissible gross mass.
- 6.5.5.6.10 The pallet or integral base shall be designed so as to avoid any protrusion of the base of the IBC that might be liable to damage in handling.
- 6.5.5.6.11 The body shall be secured to any detachable pallet to ensure stability in handling and transport. Where a detachable pallet is used, its top surface shall be free from sharp protrusions that might damage the IBC.
- 6.5.5.6.12 Strengthening devices such as timber supports to increase stacking performance may be used but shall be external to the liner.
- 6.5.5.6.13 Where IBCs are intended for stacking, the bearing surface shall be such as to distribute the load in a safe manner.
- 6.5.6 Test provisions for IBCs**
- 6.5.6.1 Performance and frequency of tests**
- 6.5.6.1.1 Each IBC design type shall successfully pass the tests prescribed in this chapter before being used. An IBC design type is defined by the design, size and material and thickness, manner of construction and means of filling and discharging, but may include various surface treatments; it also includes IBCs which differ from the design type only in their lesser external dimensions.
- 6.5.6.1.2 Tests shall be carried out on IBCs as prepared for transport. IBCs shall be filled as indicated in the relevant section. The substances to be transported in the IBCs may be replaced by other substances except where this would invalidate the results of the tests. For solids, when another substance is used, it shall have the

Chapter 6.5 – Construction and testing of intermediate bulk containers (IBCs)

same physical characteristics (mass, grain size, etc.) as the substance to be transported. It is permissible to use additives, such as bags of lead shot, to achieve the requisite total package gross mass, so long as they are placed so that the test results are not affected.

6.5.6.2 Design type tests

6.5.6.2.1 One IBC of each design type, size, wall thickness and manner of construction shall be submitted to the tests in the order shown in 6.5.6.3.5 and as set out in 6.5.6.4 to 6.5.6.13. These design type tests shall be carried out as required by the competent authority.

6.5.6.2.2 The competent authority may permit the selective testing of IBCs which differ only in minor respects from the tested type, such as with small reductions in external dimensions.

6.5.6.2.3 If detachable pallets are used in the tests, the test report issued in accordance with 6.5.6.14 shall include a technical description of the pallets to be used.

6.5.6.3 Preparation of IBC for testing

6.5.6.3.1 Paper and fibreboard IBCs and composite IBCs with fibreboard outer packagings shall be conditioned for at least 24 hours in an atmosphere having a controlled temperature and relative humidity (r.h.). There are three options, one of which shall be chosen. The preferred atmosphere is 23°C±2°C and 50%±2% r.h. The two other options are 20°C±2°C and 65%±2% r.h. or 27°C±2°C and 65%±2% r.h.

**Note:** Average values shall fall within these limits. Short-term fluctuations and measurement limitations may cause individual measurements to vary by up to ±5% relative humidity without significant impairment of test reproducibility.

6.5.6.3.2 Additional steps shall be taken to ascertain that the plastics material used in the manufacture of rigid plastics IBCs of types 31H1 and 31H2 and composite IBCs of type 31HZ1 and 31HZ2 complies with the provisions of 6.5.5.3.2 to 6.5.5.3.4 and 6.5.5.4.6 to 6.5.5.4.8.

6.5.6.3.3 This may be done, for example, by submitting sample IBCs to a preliminary test extending over a long period, for example six months, during which the samples would remain filled with the substances they are intended to contain or with substances which are known to have at least as severe a stress-cracking, weakening or molecular degradation influence on the plastics materials in question, and after which the samples shall be submitted to the applicable tests listed in the table in 6.5.6.3.5.

6.5.6.3.4 Where the behaviour of the plastics material has been established by other means, the above compatibility test may be dispensed with.

6.5.6.3.5 Design type tests required in sequential order:

| Type of IBC                 | Vibration <sup>f</sup> | Bottom lift      | Top lift <sup>a</sup> | Stacking <sup>b</sup> | Leak-proofness | Hydraulic pressure | Drop             | Tear | Topple | Righting <sup>c</sup> |
|-----------------------------|------------------------|------------------|-----------------------|-----------------------|----------------|--------------------|------------------|------|--------|-----------------------|
| <b>Metal:</b>               |                        |                  |                       |                       |                |                    |                  |      |        |                       |
| 11A, 11B, 11N               | –                      | 1st <sup>a</sup> | 2nd                   | 3rd                   | –              | –                  | 4th <sup>e</sup> | –    | –      | –                     |
| 21A, 21B, 21N               | –                      | 1st <sup>a</sup> | 2nd                   | 3rd                   | 4th            | 5th                | 6th <sup>e</sup> | –    | –      | –                     |
| 31A, 31B, 31N               | 1st                    | 2nd <sup>a</sup> | 3rd                   | 4th                   | 5th            | 6th                | 7th <sup>e</sup> | –    | –      | –                     |
| <b>Flexible<sup>d</sup></b> | –                      | –                | x <sup>c</sup>        | x                     | –              | –                  | x                | x    | x      | x                     |
| <b>Rigid plastics:</b>      |                        |                  |                       |                       |                |                    |                  |      |        |                       |
| 11H1, 11H2                  | –                      | 1st <sup>a</sup> | 2nd                   | 3rd                   | –              | –                  | 4th              | –    | –      | –                     |
| 21H1, 21H2                  | –                      | 1st <sup>a</sup> | 2nd                   | 3rd                   | 4th            | 5th                | 6th              | –    | –      | –                     |
| 31H1, 31H2                  | 1st                    | 2nd <sup>a</sup> | 3rd                   | 4th                   | 5th            | 6th                | 7th              | –    | –      | –                     |
| <b>Composite:</b>           |                        |                  |                       |                       |                |                    |                  |      |        |                       |
| 11HZ1, 11HZ2                | –                      | 1st <sup>a</sup> | 2nd                   | 3rd                   | –              | –                  | 4th <sup>e</sup> | –    | –      | –                     |
| 21HZ1, 21HZ2                | –                      | 1st <sup>a</sup> | 2nd                   | 3rd                   | 4th            | 5th                | 6th <sup>e</sup> | –    | –      | –                     |
| 31HZ1, 31HZ2                | 1st                    | 2nd <sup>a</sup> | 3rd                   | 4th                   | 5th            | 6th                | 7th <sup>e</sup> | –    | –      | –                     |
| <b>Fibreboard</b>           | –                      | 1st              | –                     | 2nd                   | –              | –                  | 3rd              | –    | –      | –                     |
| <b>Wooden</b>               | –                      | 1st              | –                     | 2nd                   | –              | –                  | 3rd              | –    | –      | –                     |

<sup>a</sup> When IBCs are designed for this method of handling.

<sup>b</sup> When IBCs are designed to be stacked.

<sup>c</sup> When IBCs are designed to be lifted from the top or the side.

<sup>d</sup> Required test indicated by “x”; an IBC which has passed one test may be used for other tests, in any order.

<sup>e</sup> Another IBC of the same design may be used for the drop test.

<sup>f</sup> Another IBC of the same design may be used for the vibration test.

**Part 6 – Construction and testing of packagings, IBCs, etc.**

---

**6.5.6.4 Bottom lift test****6.5.6.4.1 Applicability**

For all fibreboard and wooden IBCs and for all types of IBCs which are fitted with means for lifting from the base, as a design type test.

**6.5.6.4.2 Preparation of the IBC for test**

The IBC shall be filled. A load shall be added and evenly distributed. The mass of filled IBC and the load shall be 1.25 times its maximum permissible gross mass.

**6.5.6.4.3 Method of testing**

The IBC shall be raised and lowered twice by a forklift truck with the forks centrally positioned so that the space between them is three quarters of the length of the side of entry (unless the points of entry are fixed). The forks shall penetrate to three quarters of the depth in the direction of entry. The test shall be repeated from each possible direction of entry.

**6.5.6.4.4 Criteria for passing the test**

No permanent deformation which renders the IBC, including the base pallet, if any, unsafe for transport and no loss of contents.

**6.5.6.5 Top lift test****6.5.6.5.1 Applicability**

For all types of IBCs which are designed to be lifted from the top, and for flexible IBCs designed to be lifted from the top or the side, as a design type test.

**6.5.6.5.2 Preparation of the IBC for test**

Metal, rigid plastics and composite IBCs shall be filled. A load shall be added and evenly distributed. The mass of filled IBC and the load shall be twice the maximum permissible gross mass. Flexible IBCs shall be filled with a representative material and then shall be loaded to six times their maximum permissible gross mass, the load being evenly distributed.

**6.5.6.5.3 Method of testing**

Metal and flexible IBCs shall be lifted in the manner for which they are designed until clear of the floor and maintained in that position for a period of five minutes.

Rigid plastics and composite IBCs shall be lifted:

- .1 by each pair of diagonally opposite lifting devices, so that the hoisting forces are applied vertically, for a period of five minutes; and
- .2 by each pair of diagonally opposite lifting devices, so that the hoisting forces are applied towards the centre at 45° to the vertical, for a period of five minutes.

6.5.6.5.4 Other methods of top-lift testing and preparation at least equally effective may be used for flexible IBCs.

**6.5.6.5.5 Criteria for passing the test**

- .1 Metal, rigid plastics and composite IBCs: the IBC remains safe for normal conditions of transport, there is no observable permanent deformation of the IBC, including the base pallet, if any, and no loss of contents.
- .2 Flexible IBCs: no damage to the IBC or its lifting devices which renders the IBC unsafe for transport or handling and no loss of contents.

**6.5.6.6 Stacking test****6.5.6.6.1 Applicability**

For all types of IBCs which are designed to be stacked on each other, as a design type test.

**6.5.6.6.2 Preparation of the IBC for test**

The IBC shall be filled to its maximum permissible gross mass. If the specific gravity of the product being used for testing makes this impracticable, the IBC shall additionally be loaded so that it is tested at its maximum permissible gross mass, the load being evenly distributed.

**6.5.6.6.3 Method of testing**

- .1 The IBC shall be placed on its base on level hard ground and subjected to a uniformly distributed superimposed test load (see 6.5.6.6.4). IBCs shall be subjected to the test load for a period of at least:
  - 5 minutes, for metal IBCs;
  - 28 days at 40°C, for rigid plastics IBCs of types 11H2, 21H2 and 31H2 and for composite IBCs with outer packagings of plastics material which bear the stacking load (i.e. types 11HH1, 11HH2, 21HH1, 21HH2, 31HH1 and 31HH2);
  - 24 hours, for all other types of IBCs.
- .2 The load shall be applied by one of the following methods:
  - one or more IBCs of the same type, filled to the maximum permissible gross mass, stacked on the test IBC;
  - appropriate mass loaded on to either a flat plate or a reproduction of the base of the IBC, which is stacked on the test IBC.

**6.5.6.6.4 Calculation of superimposed test load**

The load to be placed on the IBC shall be 1.8 times the combined maximum permissible gross mass of the number of similar IBCs that may be stacked on top of the IBC during transport.

**6.5.6.6.5 Criteria for passing the test**

- .1 All types of IBCs other than flexible IBCs: no permanent deformation which renders the IBC, including the base pallet, if any, unsafe for transport and no loss of contents.
- .2 Flexible IBCs: no deterioration of the body which renders the IBC unsafe for transport and no loss of contents.

**6.5.6.7 Leakproofness test****6.5.6.7.1 Applicability**

For those types of IBCs used for liquids, or for solids filled or discharged under pressure, as a design type test and a periodic test.

**6.5.6.7.2 Preparation of the IBC for test**

The test shall be carried out before the fitting of any thermal insulation equipment. Vented closures shall either be replaced by similar non-vented closures or the vent shall be sealed.

**6.5.6.7.3 Method of testing and pressure to be applied**

The test shall be carried out for a period of at least 10 minutes, using air at a gauge pressure of not less than 20 kPa (0.2 bar). The airtightness of the IBC shall be determined by a suitable method such as air-pressure differential test or by immersing the IBC in water, or for metal IBCs, by coating the seams and joints with a soap solution. In the latter case, a correction factor shall be applied for the hydrostatic pressure.

**6.5.6.7.4 Criterion for passing the test**

No leakage of air.

**6.5.6.8 Hydraulic pressure test****6.5.6.8.1 Applicability**

For those types of IBCs used for liquids or for solids filled or discharged under pressure, as a design type test.

**6.5.6.8.2 Preparation of the IBC for test**

The test shall be carried out before the fitting of any thermal insulation equipment. Pressure relief devices shall be removed and their apertures plugged, or shall be rendered inoperative.

**6.5.6.8.3 Method of testing**

The test shall be carried out for a period of at least ten minutes, applying a hydraulic pressure of not less than that indicated in 6.5.6.8.4. The IBC shall not be mechanically restrained during the test.

**Part 6 – Construction and testing of packagings, IBCs, etc.****6.5.6.8.4 Pressures to be applied****6.5.6.8.4.1 Metal IBCs:**

- .1 For IBCs of types 21A, 21B and 21N, for packing group I solids, a 250 kPa (2.5 bar) gauge pressure;
- .2 For IBCs of types 21A, 21B, 21N, 31A, 31B and 31N, for packing groups II or III substances, a 200 kPa (2 bar) gauge pressure;
- .3 In addition, for IBCs of types 31A, 31B and 31N, a 65 kPa (0.65 bar) gauge pressure. This test shall be performed before the 200 kPa (2 bar) test.

**6.5.6.8.4.2 Rigid plastics and composite IBCs:**

- .1 For IBCs of types 21H1, 21H2, 21HZ1 and 21HZ2: 75 kPa (0.75 bar) gauge;
- .2 For IBCs of types 31H1, 31H2, 31HZ1 and 31HZ2: whichever is the greater of two values, the first as determined by one of the following methods:
  - the total gauge pressure measured in the IBC (i.e. the vapour pressure of the filling substance and the partial pressure of the air or other inert gases, minus 100 kPa) at 55°C multiplied by a safety factor of 1.5; this total gauge pressure shall be determined on the basis of a maximum degree of filling in accordance with 4.1.1.4 and a filling temperature of 15°C; or
  - 1.75 times the vapour pressure at 50°C of the substance to be transported minus 100 kPa, but with a minimum test pressure of 100 kPa; or
  - 1.5 times the vapour pressure at 55°C of the substance to be transported minus 100 kPa, but with a minimum test pressure of 100 kPa;
 and the second as determined by the following method:
  - twice the static pressure of the substance to be transported, with a minimum of twice the static pressure of water.

**6.5.6.8.5 Criteria for passing the test(s)**

- .1 For IBCs of types 21A, 21B, 21N, 31A, 31B and 31N, when subjected to the test pressure specified in 6.5.6.8.4.1.1 or .2: no leakage;
- .2 For IBCs of types 31A, 31B and 31N, when subjected to the test pressure specified in 6.5.6.8.4.1.3: neither permanent deformation which would render the IBC unsafe for transport nor leakage; and
- .3 For rigid plastics and composite IBCs: no permanent deformation which would render the IBC unsafe for transport and no leakage.

**6.5.6.9 Drop test****6.5.6.9.1 Applicability**

For all types of IBCs, as a design type test.

**6.5.6.9.2 Preparation of the IBC for test**

- .1 Metal IBCs: the IBC shall be filled to not less than 95% of its maximum capacity for solids or 98% of its maximum capacity for liquids. Pressure relief devices shall be rendered inoperative or shall be removed and their apertures sealed.
- .2 Flexible IBCs: the IBC shall be filled to the maximum permissible gross mass, the contents being evenly distributed.
- .3 Rigid plastics and composite IBCs: the IBC shall be filled to not less than 95% of its maximum capacity for solids or 98% of its maximum capacity for liquids. Arrangements provided for pressure relief may be removed and sealed or rendered inoperative. Testing of IBCs shall be carried out when the temperature of the test sample and its contents has been reduced to –18°C or lower. Where test samples of composite IBCs are prepared in this way, the conditioning specified in 6.5.6.3.1 may be waived. Test liquids shall be kept in the liquid state, if necessary by the addition of anti-freeze. This conditioning may be disregarded if the materials in question are of sufficient ductility and tensile strength at low temperatures.
- .4 Fibreboard and wooden IBCs: the IBC shall be filled to not less than 95% of its maximum capacity.

**6.5.6.9.3 Method of testing**

The IBC shall be dropped on its base onto a non-resilient, horizontal, flat, massive and rigid surface in conformity with the requirements of 6.1.5.3.4, in such a manner as to ensure that the point of impact is that part of the base of the IBC considered to be the most vulnerable. IBCs of 0.45 m<sup>3</sup> or less capacity shall also be dropped:

- .1 Metal IBCs: on the most vulnerable part other than the part of the base of the IBC tested in the first drop;
- .2 Flexible IBCs: on the most vulnerable side;

- .3 Rigid plastics, composite, fibreboard and wooden IBCs: flat on a side, flat on the top and on a corner.  
The same IBC or a different IBC of the same design may be used for each drop.

**6.5.6.9.4 Drop height**

For solids and liquids, if the test is performed with the solid or liquid to be transported or with another substance having essentially the same physical characteristics:

| Packing group I | Packing group II | Packing group III |
|-----------------|------------------|-------------------|
| 1.8 m           | 1.2 m            | 0.8 m             |

For liquids, if the test is performed with water:

- (a) where the substances to be transported have a relative density not exceeding 1.2:

| Packing group II | Packing group III |
|------------------|-------------------|
| 1.2 m            | 0.8 m             |

- (b) where the substances to be transported have a relative density exceeding 1.2, the drop heights shall be calculated on the basis of the relative density ( $d$ ) of the substance to be transported rounded up to the first decimal as follows:

| Packing group II | Packing group III |
|------------------|-------------------|
| $d \times 1.0$ m | $d \times 0.67$ m |

**6.5.6.9.5 Criteria for passing the test(s)**

- .1 Metal IBCs: no loss of contents.
- .2 Flexible IBCs: no loss of contents. A slight discharge, such as from closures or stitch holes, upon impact shall not be considered to be a failure of the IBC provided that no further leakage occurs after the IBC has been raised clear of the ground.
- .3 Rigid plastics, composite, fibreboard and wooden IBCs: no loss of contents. A slight discharge from a closure upon impact shall not be considered to be a failure of the IBC provided that no further leakage occurs.
- .4 All IBCs: no damage which renders the IBC unsafe to be transported for salvage or for disposal, and no loss of contents. In addition, the IBC shall be capable of being lifted by an appropriate means until clear of the floor for five minutes.

**Note:** The criterion in 6.5.6.9.5.4 applies to design types for IBCs manufactured as from 1 January 2011.

**6.5.6.10 Tear test**

**6.5.6.10.1 Applicability**

For all types of flexible IBCs, as a design type test.

**6.5.6.10.2 Preparation of the IBC for test**

The IBC shall be filled to not less than 95% of its capacity and to its maximum permissible gross mass, the contents being evenly distributed.

**6.5.6.10.3 Method of testing**

Once the IBC is placed on the ground, a 100 mm knife score, completely penetrating the wall of a wide face, is made at a 45° angle to the principal axis of the IBC, halfway between the bottom surface and the top level of the contents. The IBC shall then be subjected to a uniformly distributed superimposed load equivalent to twice the maximum permissible gross mass. The load shall be applied for at least five minutes. An IBC which is designed to be lifted from the top or the side shall then, after removal of the superimposed load, be lifted until it is clear of the floor and maintained in that position for a period of five minutes.

**6.5.6.10.4 Criterion for passing the test**

The cut shall not propagate more than 25% of its original length.

Part 6 – Construction and testing of packagings, IBCs, etc.

6.5.6.11 Topple test

6.5.6.11.1 *Applicability*

For all types of flexible IBCs, as a design type test.

6.5.6.11.2 *Preparation of the IBC for test*

The IBC shall be filled to not less than 95% of its capacity and to its maximum permissible gross mass, the contents being evenly distributed.

6.5.6.11.3 *Method of testing*

The IBC shall be caused to topple onto any part of its top onto a rigid, non-resilient, smooth, flat and horizontal surface.

6.5.6.11.4 *Topple height*

| Packing group I | Packing group II | Packing group III |
|-----------------|------------------|-------------------|
| 1.8 m           | 1.2 m            | 0.8 m             |

6.5.6.11.5 *Criterion for passing the test*

No loss of contents. A slight discharge, such as from closures or stitch holes, upon impact shall not be considered to be a failure of the IBC provided that no further leakage occurs.

6.5.6.12 Righting test

6.5.6.12.1 *Applicability*

For all flexible IBCs designed to be lifted from the top or side, as a design type test.

6.5.6.12.2 *Preparation of the IBC for test*

The IBC shall be filled to not less than 95% of its capacity and its maximum permissible gross mass, the contents being evenly distributed.

6.5.6.12.3 *Method of testing*

The IBC, lying on its side, shall be lifted at a speed of 0.1 m/s to an upright position, clear of the floor, by one lifting device or by two lifting devices when four are provided.

6.5.6.12.4 *Criterion for passing the test*

No damage to the IBC or its lifting devices which renders the IBC unsafe for transport or handling.

6.5.6.13 Vibration test

6.5.6.13.1 *Applicability*

For all IBCs used for liquids, as a design type test.

**Note:** This test applies to design types for IBCs manufactured as from 1 January 2011.

6.5.6.13.2 *Preparation of the IBC for test*

A sample IBC shall be selected at random and shall be fitted and closed as for transport. The IBC shall be filled with water to not less than 98% of its maximum capacity.

6.5.6.13.3 *Test method and duration*

6.5.6.13.3.1 The IBC shall be placed in the centre of the test machine platform with a vertical sinusoidal, double amplitude (peak-to-peak displacement) of 25 mm ± 5%. If necessary, restraining devices shall be attached to the platform to prevent the specimen from moving horizontally off the platform without restricting vertical movement.

6.5.6.13.3.2 The test shall be conducted for one hour at a frequency that causes part of the base of the IBC to be momentarily raised from the vibrating platform for part of each cycle to such a degree that a metal shim can be completely inserted intermittently at, at least, one point between the base of the IBC and the test platform. The frequency may need to be adjusted after the initial set point to prevent the packaging from going into





resonance. Nevertheless, the test frequency shall continue to allow placement of the metal shim under the IBC as described in this paragraph. The continuing ability to insert the metal shim is essential to passing the test. The metal shim used for this test shall be at least 1.6 mm thick, 50 mm wide, and be of sufficient length to be inserted between the IBC and the test platform a minimum of 100 mm to perform the test.

**6.5.6.13.4** *Criteria for passing the test*

No leakage or rupture shall be observed. In addition, no breakage or failure of structural components, such as broken welds or failed fastenings, shall be observed.

**6.5.6.14** **Test report**

**6.5.6.14.1** A test report containing at least the following particulars shall be drawn up and shall be available to the users of the IBC:

- .1 name and address of the test facility;
- .2 name and address of applicant (where appropriate);
- .3 a unique test report identification;
- .4 date of the test report;
- .5 manufacturer of the IBC;
- .6 description of the IBC design type (such as dimensions, materials, closures, thickness, etc.), including method of manufacture (such as blow-moulding), and which may include drawing(s) and/or photograph(s);
- .7 maximum capacity;
- .8 characteristics of test contents, such as viscosity and relative density for liquids and particle size for solids. For rigid plastics and composite IBCs subject to the hydraulic pressure test in 6.5.6.8, the temperature of the water used;
- .9 test descriptions and results; and
- .10 signature, with the name and status of the signatory.

**6.5.6.14.2** The test report shall contain statements that the IBC, prepared as for transport, was tested in accordance with the appropriate provisions of this chapter and that the use of other packaging methods or components may render it invalid. A copy of the test report shall be available to the competent authority.

## Chapter 6.6

### *Provisions for the construction and testing of large packagings*

#### 6.6.1 General

6.6.1.1 The provisions of this chapter do not apply to:

- class 2, except articles including aerosols;
- class 6.2, except clinical waste of UN 3291;
- class 7 packages containing radioactive material.

6.6.1.2 Large packagings shall be manufactured, tested and remanufactured under a quality-assurance programme which satisfies the competent authority in order to ensure that each manufactured or remanufactured large packaging meets the provisions of this chapter.

**Note:** ISO 16106:2020, *Transport packages for dangerous goods – Dangerous goods packagings, intermediate bulk containers (IBCs) and large packagings – Guidelines for the application of ISO 9001*, provides acceptable guidance on procedures which may be followed.

6.6.1.3 The specific requirements for large packagings in 6.6.4 are based on large packagings currently used. In order to take into account progress in science and technology, there is no objection to the use of large packagings having specifications different from those in 6.6.4 provided they are equally effective, acceptable to the competent authority and able to successfully fulfil the provisions described in 6.6.5. Methods of testing other than those prescribed in this Code are acceptable provided they are equivalent.

6.6.1.4 Manufacturers and subsequent distributors of packagings shall provide information regarding procedures to be followed and a description of the types and dimensions of closures (including required gaskets) and any other components needed to ensure that packages as presented for transport are capable of passing the applicable performance tests of this chapter.

#### 6.6.2 Code for designating types of large packagings

6.6.2.1 The code used for large packagings consists of:

- (a) two Arabic numerals:
  - “50” for rigid large packagings; or
  - “51” for flexible large packagings; and
- (b) capital letters in Latin characters indicating the nature of the material, such as wood, steel, etc. The capital letters used shall be those shown in 6.1.2.6.

6.6.2.2 The letters “T” or “W” may follow the large packaging code. The letter “T” signifies a large salvage packaging conforming to the requirements of 6.6.5.1.9. The letter “W” signifies that the large packaging, although of the same type as indicated by the code, is manufactured to a specification different from those in 6.6.4 and is considered equivalent in accordance with the requirements in 6.6.1.3.

#### 6.6.3 Marking

##### 6.6.3.1 Primary marking

Each large packaging manufactured and intended for the use according to this Code shall bear marks which are durable, legible and placed in a location so as to be readily visible. Letters, numerals and symbols shall be at least 12 mm high and shall show:

- (a) The United Nations packaging symbol:



This symbol shall not be used for any purpose other than certifying that a packaging, a flexible bulk container, a portable tank or a MEGC complies with the relevant requirements in chapters 6.1, 6.2, 6.3, 6.5, 6.6, 6.7 or 6.9. For metal large packagings on which the marks are stamped or embossed, the capital letters “UN” may apply instead of the symbol.

- (b) The code “50” designating a large rigid packaging or “51” for flexible large packagings, followed by the material type in accordance with 6.5.1.4.1.2.
- (c) A capital letter designating the packing group(s) for which the design type has been approved:  
“X” for packing groups I, II and III  
“Y” for packing groups II and III  
“Z” for packing group III only.
- (d) The month and year (last two digits) of manufacture.
- (e) The State authorizing the allocation of the marks, indicated by the distinguishing sign used on vehicles in international road traffic.\*
- (f) The name or symbol of the manufacturer and other identification of the large packagings as specified by the competent authority.
- (g) The stacking test load in kilograms. For large packagings not designed for stacking, the figure “0” shall be shown.
- (h) The maximum permissible gross mass in kilograms.

The primary mark required above shall be applied in the sequence of the subparagraphs. Each mark applied in accordance with subparagraphs (a) to (h) shall be clearly separated, such as by a slash or space, so as to be easily identifiable.

### 6.6.3.2 Examples of marking

|  |                                  |   |
|--|----------------------------------|---|
|  | 50A/X/05 01/N/PQRS<br>2500/1000  | For a large steel packaging suitable for stacking; stacking load: 2,500 kg; maximum gross mass: 1,000 kg.         |
|  | 50AT/Y/05/01/B/PQRS<br>2500/1000 | For a large steel salvage packaging suitable for stacking; stacking load: 2,500 kg; maximum gross mass: 1,000 kg. |
|  | 50H/Y/04 02/D/ABCD 987<br>0/800  | For a large plastics packaging not suitable for stacking; maximum gross mass: 800 kg.                             |
|  | 51H/Z/06 01/S/1999<br>0/500      | For a large flexible packaging not suitable for stacking; maximum gross mass: 500 kg.                             |

6.6.3.3 The maximum permitted stacking load applicable shall be displayed on a symbol as shown in the figures below. The symbol shall be durable and clearly visible.

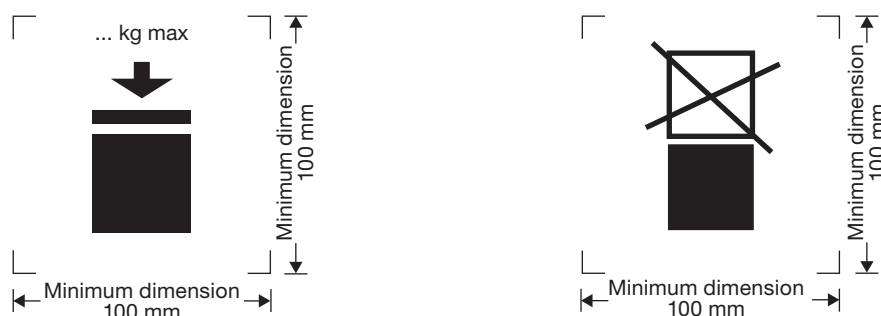

Large packagings capable of being stacked

Large packagings NOT capable of being stacked

The minimum dimensions shall be 100 mm × 100 mm. The letters and numbers indicating the mass shall be at least 12 mm high. The area within the printer’s marks indicated by the dimensional arrows shall be square. Where dimensions are not specified, all features shall be in approximate proportion to those shown. The mass marked above the symbol shall not exceed the load imposed during the design type test (see 6.6.5.3.3.4) divided by 1.8.

\* Distinguishing sign of the State of registration used on motor vehicles and trailers in international road traffic, e.g. in accordance with the Geneva Convention on Road Traffic of 1949 or the Vienna Convention on Road Traffic of 1968.

**Part 6 – Construction and testing of packagings, IBCs, etc.**

**Note:** The provisions of 6.6.3.3 shall apply to all large packagings manufactured, repaired or remanufactured as from 1 January 2015. The provisions of 6.6.3.3 of the IMDG Code (amendment 36-12) may continue to be applied to all large packagings manufactured, repaired or remanufactured between 1 January 2015 and 31 December 2016.

6.6.3.4 Where a large packaging conforms to one or more than one tested large packaging design type, including one or more than one tested packaging or IBC design type, the large packaging may bear more than one mark to indicate the relevant performance test requirements that have been met. Where more than one mark appears on a large packaging, the marks shall appear in close proximity to one another and each mark shall appear in its entirety.

## 6.6.4 Specific provisions for large packagings

### 6.6.4.1 Specific provisions for metal large packagings

- 50A steel
- 50B aluminium
- 50N metal (other than steel or aluminium)

6.6.4.1.1 The large packaging shall be made of suitable ductile metal in which the weldability has been fully demonstrated. Welds shall be skillfully made and afford complete safety. Low-temperature performance shall be taken into account when appropriate.

6.6.4.1.2 Care shall be taken to avoid damage by galvanic action due to the juxtaposition of dissimilar metals.

### 6.6.4.2 Specific provisions for flexible material large packagings

- 51H flexible plastics
- 51M flexible paper

6.6.4.2.1 The large packaging shall be manufactured from suitable materials. The strength of the material and the construction of the flexible large packaging shall be appropriate to its capacity and its intended use.

6.6.4.2.2 All materials used in the construction of flexible large packagings of types 51M shall, after complete immersion in water for not less than 24 hours, retain at least 85% of the tensile strength as measured originally on the material conditioned to equilibrium at 67% relative humidity or less.

6.6.4.2.3 Seams shall be formed by stitching, heat sealing, gluing or any equivalent method. All stitched seam-ends shall be secured.

6.6.4.2.4 Flexible large packagings shall provide adequate resistance to ageing and to degradation caused by ultraviolet radiation or the climatic conditions, or by the substance contained, thereby rendering them appropriate to their intended use.

6.6.4.2.5 For plastics flexible large packagings where protection against ultraviolet radiation is required, it shall be provided by the addition of carbon black or other suitable pigments or inhibitors. These additives shall be compatible with the contents and remain effective throughout the life of the large packaging. Where use is made of carbon black, pigments or inhibitors other than those used in the manufacture of the tested design type, re-testing may be waived if changes in the carbon black content, the pigment content or the inhibitor content do not adversely affect the physical properties of the material of construction.

6.6.4.2.6 Additives may be incorporated into the material of the large packaging to improve the resistance to ageing or to serve other purposes, provided that these do not adversely affect the physical or chemical properties of the material.

6.6.4.2.7 When filled, the ratio of height to width shall be not more than 2:1.

### 6.6.4.3 Specific provisions for plastics large packagings

- 50H rigid plastics

6.6.4.3.1 The large packaging shall be manufactured from suitable plastics material of known specifications and be of adequate strength in relation to its capacity and its intended use. The material shall be adequately resistant to ageing and to degradation caused by the substance contained or, where relevant, by ultraviolet radiation. Low-temperature performance shall be taken into account when appropriate. Any permeation of the substance contained shall not constitute a danger under normal conditions of transport.

6.6.4.3.2 Where protection against ultraviolet radiation is required, it shall be provided by the addition of carbon black or other suitable pigments or inhibitors. These additives shall be compatible with the contents and remain effective throughout the life of the outer packaging. Where use is made of carbon black, pigments or inhibitors

other than those used in the manufacture of the tested design type, re-testing may be waived if changes in the carbon black content, the pigment content or the inhibitor content do not adversely affect the physical properties of the material of construction.

6.6.4.3.3 Additives may be incorporated into the material of the large packaging to improve the resistance to ageing or to serve other purposes, provided that these do not adversely affect the physical or chemical properties of the material.

#### 6.6.4.4 Specific provisions for fibreboard large packagings

50G rigid fibreboard

△ 6.6.4.4.1 Strong and good-quality solid or double-faced corrugated fibreboard (single or multiwall) shall be used, appropriate to the capacity of the large packagings and to their intended use. The water resistance of the outer surface shall be such that the increase in mass, as determined in a test carried out over a period of 30 minutes by the Cobb method of determining water absorption, is not greater than  $155 \text{ g/m}^2$  – see ISO 535:2014. It shall have proper bending qualities. Fibreboard shall be cut, creased without scoring, and slotted so as to permit assembly without cracking, surface breaks or undue bending. The fluting of corrugated fibreboard shall be firmly glued to the facings.

6.6.4.4.2 The walls, including top and bottom, shall have a minimum puncture resistance of 15 J, measured according to ISO 3036:1975.

6.6.4.4.3 Manufacturing joins in the outer packaging of large packagings shall be made with an appropriate overlap and shall be taped, glued, stitched with metal staples or fastened by other means at least equally effective. Where joins are effected by gluing or taping, a water-resistant adhesive shall be used. Metal staples shall pass completely through all pieces to be fastened and be formed or protected so that any inner liner cannot be abraded or punctured by them.

6.6.4.4.4 Any integral pallet base forming part of a large packaging or any detachable pallet shall be suitable for mechanical handling with the large packaging filled to its maximum permissible gross mass.

6.6.4.4.5 The pallet or integral base shall be designed so as to avoid any protrusion of the base of the large packaging that might be liable to damage in handling.

6.6.4.4.6 The body shall be secured to any detachable pallet to ensure stability in handling and transport. Where a detachable pallet is used, its top surface shall be free from sharp protrusions that might damage the large packaging.

6.6.4.4.7 Strengthening devices such as timber supports to increase stacking performance may be used but shall be external to the liner.

6.6.4.4.8 Where large packagings are intended for stacking, the bearing surface shall be such as to distribute the load in a safe manner.

#### 6.6.4.5 Specific provisions for wooden large packagings

50C natural wood

50D plywood

50F reconstituted wood

6.6.4.5.1 The strength of the materials used and the method of construction shall be appropriate to the capacity and intended use of the large packagings.

6.6.4.5.2 Natural wood shall be well seasoned, commercially dry and free from defects that would materially lessen the strength of any part of the large packaging. Each part of the large packaging shall consist of one piece or be equivalent thereto. Parts are considered equivalent to one piece when a suitable method of glued assembly is used, as for instance Lindermann joint, tongue and groove joint, ship lap or rabbet joint, or butt joint with at least two corrugated metal fasteners at each joint, or when other methods at least equally effective are used.

6.6.4.5.3 Large packagings of plywood shall be at least three-ply. They shall be made of well-seasoned rotary-cut, sliced or sawn veneer, commercially dry and free from defects that would materially lessen the strength of the large packaging. All adjacent plies shall be glued with water-resistant adhesive. Other suitable materials may be used with plywood for the construction of the large packaging.

6.6.4.5.4 Large packagings of reconstituted wood shall be made of water-resistant reconstituted wood such as hardboard, particle board or other suitable type.

6.6.4.5.5 Large packagings shall be firmly nailed or secured to corner posts or ends or be assembled by equally suitable devices.

**Part 6 – Construction and testing of packagings, IBCs, etc.**

- 6.6.4.5.6 Any integral pallet base forming part of a large packaging or any detachable pallet shall be suitable for mechanical handling with the large packaging filled to its maximum permissible gross mass.
- 6.6.4.5.7 The pallet or integral base shall be designed so as to avoid any protrusion of the base of the large packaging that might be liable to damage in handling.
- 6.6.4.5.8 The body shall be secured to any detachable pallet to ensure stability in handling and transport. Where a detachable pallet is used, its top surface shall be free from sharp protrusions that might damage the large packaging.
- 6.6.4.5.9 Strengthening devices such as timber supports to increase stacking performance may be used but shall be external to the liner.
- 6.6.4.5.10 Where large packagings are intended for stacking, the bearing surface shall be such as to distribute the load in a safe manner.

**6.6.5 Test provisions for large packagings****6.6.5.1 Performance and frequency of test**

- 6.6.5.1.1 The design type of each large packaging shall be tested as provided in 6.6.5.3 in accordance with procedures established by the competent authority.
- 6.6.5.1.2 Each large packaging design type shall successfully pass the tests prescribed in this chapter before being used. A large packaging design type is defined by the design, size, material and thickness, manner of construction and packing, but may include various surface treatments. It also includes large packagings that differ from the design type only in their lesser design height.
- 6.6.5.1.3 Tests shall be repeated on production samples at intervals established by the competent authority. For such tests on fibreboard large packagings, preparation at ambient conditions is considered equivalent to the provisions of 6.6.5.2.4.
- 6.6.5.1.4 Tests shall also be repeated after each modification which alters the design, material or manner of construction of large packagings.
- 6.6.5.1.5 The competent authority may permit the selective testing of large packagings that differ only in minor respects from a tested type, such as smaller sizes of inner packagings or inner packagings of lower net mass, and large packagings which are produced with small reductions in external dimension(s).
- 6.6.5.1.6 [Reserved]
- Note:** For the conditions for assembling different inner packagings in a large packaging and permissible variations in inner packagings, see 4.1.1.5.1.
- 6.6.5.1.7 The competent authority may at any time require proof, by tests in accordance with this section, that serially produced large packagings meet the provisions of the design type tests.
- 6.6.5.1.8 Provided the validity of the test results is not affected, and with the approval of the competent authority, several tests may be made on one sample.

**6.6.5.1.9 Large salvage packagings**

Large salvage packagings shall be tested and marked in accordance with the provisions applicable to packing group II large packagings intended for the transport of solids or inner packagings, except as follows:

- (a) The test substance used in performing the tests shall be water, and the large salvage packagings shall be filled to not less than 98% of their maximum capacity. It is permissible to use additives, such as bags of lead shot, to achieve the requisite total package mass so long as they are placed so that the test results are not affected. Alternatively, in performing the drop test, the drop height may be varied in accordance with 6.6.5.3.4.4.2(b);
- (b) Large salvage packagings shall, in addition, have been successfully subjected to the leakproofness test at 30 kPa, with the results of this test reflected in the test report required by 6.6.5.4; and
- (c) Large salvage packagings shall be marked with the letter “T” as described in 6.6.2.2.

**6.6.5.2 Preparation for testing**

- 6.6.5.2.1 Tests shall be carried out on large packagings prepared as for transport, including the inner packagings or articles used. Inner packagings shall be filled to not less than 98% of their maximum capacity for liquids or 95% for solids. For large packagings where the inner packagings are designed to carry liquids and solids, separate testing is required for both liquid and solid contents. The substances in the inner packagings or

the articles to be transported in the large packagings may be replaced by other material or articles except where this would invalidate the results of the tests. When other inner packagings or articles are used, they shall have the same physical characteristics (mass, etc.) as the inner packagings or articles to be carried. It is permissible to use additives, such as bags of lead shot, to achieve the requisite total package mass, so long as they are placed so that the test results are not affected.

**6.6.5.2.2** In the drop tests for liquids, when another substance is used, it shall be of similar relative density and viscosity to those of the substance being transported. Water may also be used for the liquid drop test under the conditions in 6.6.5.3.4.4.

**6.6.5.2.3** Large packagings made of plastics materials and large packagings containing inner packagings of plastic materials – other than bags intended to contain solids or articles – shall be drop tested when the temperature of the test sample and its contents has been reduced to  $-18^{\circ}\text{C}$  or lower. This conditioning may be disregarded if the materials in question are of sufficient ductility and tensile strength at low temperatures. Where test samples are prepared in this way, the conditioning in 6.6.5.2.4 may be waived. Test liquids shall be kept in the liquid state by the addition of anti-freeze if necessary.

**6.6.5.2.4** Large packagings of fibreboard shall be conditioned for at least 24 hours in an atmosphere having a controlled temperature and relative humidity (r.h). There are three options, one of which shall be chosen. The preferred atmosphere is  $23^{\circ}\text{C}\pm 2^{\circ}\text{C}$  and  $50\%\pm 2\%$  r.h. The two other options are  $20^{\circ}\text{C}\pm 2^{\circ}\text{C}$  and  $65\%\pm 2\%$  r.h. or  $27^{\circ}\text{C}\pm 2^{\circ}\text{C}$  and  $65\%\pm 2\%$  r.h.

**Note:** Average values shall fall within these limits. Short-term fluctuation and measurement limitations may cause individual measurements to vary by up to  $\pm 5\%$  relative humidity without significant impairment of test reproducibility.

### **6.6.5.3** Test provisions

#### **6.6.5.3.1** *Bottom lift test*

##### **6.6.5.3.1.1** *Applicability*

For all types of large packagings which are fitted with means of lifting from the base, as a design type test.

##### **6.6.5.3.1.2** *Preparation of large packaging for test*

The large packaging shall be filled to 1.25 times its maximum permissible gross mass, the load being evenly distributed.

##### **6.6.5.3.1.3** *Method of testing*

The large packaging shall be raised and lowered twice by a lift truck with the forks centrally positioned and spaced at three quarters of the dimension of the side of entry (unless the points of entry are fixed). The forks shall penetrate to three quarters of the depth in the direction of entry. The test shall be repeated from each possible direction of entry.

##### **6.6.5.3.1.4** *Criteria for passing the test*

No permanent deformation which renders the large packaging unsafe for transport and no loss of contents.

#### **6.6.5.3.2** *Top lift test*

##### **6.6.5.3.2.1** *Applicability*

For types of large packaging which are intended to be lifted from the top and fitted with means of lifting, as a design type test.

##### **6.6.5.3.2.2** *Preparation of large packaging for test*

The large packaging shall be loaded to twice its maximum permissible gross mass. A flexible large packaging shall be loaded to six times its maximum permissible gross mass, the load being evenly distributed.

##### **6.6.5.3.2.3** *Method of testing*

The large packaging shall be lifted in the manner for which it is designed until clear of the floor and maintained in that position for a period of five minutes.

##### **6.6.5.3.2.4** *Criteria for passing the test*

- $\Delta$  .1 All types of large packagings other than flexible: no permanent deformation which renders the large packaging, including the base pallet, if any, unsafe for transport and no loss of contents.
- .2 Flexible large packagings: no damage to the large packaging or its lifting devices which renders the large packaging unsafe for transport or handling and no loss of contents.



Part 6 – Construction and testing of packagings, IBCs, etc.

6.6.5.3.3 **Stacking test**

6.6.5.3.3.1 *Applicability*

For all types of large packaging which are designed to be stacked on each other, as a design type test.

6.6.5.3.3.2 *Preparation of large packaging for test*

The large packaging shall be filled to its maximum permissible gross mass.

6.6.5.3.3.3 *Method of testing*

The large packaging shall be placed on its base on level hard ground and subjected to a uniformly distributed superimposed test load (see 6.6.5.3.3.4) for a period of at least five minutes: for large packaging of wood, fibreboard and plastics materials for a period of 24 hours.

6.6.5.3.3.4 *Calculation of superimposed test load*

The load to be placed on the large packaging shall be 1.8 times the combined maximum permissible gross mass of the number of similar large packagings that may be stacked on top of the large packaging during transport.

6.6.5.3.3.5 *Criteria for passing the test*

- .1 All types of large packagings other than flexible large packagings: no permanent deformation which renders the large packaging, including the base pallet, if any, unsafe for transport and no loss of contents.
- .2 Flexible large packagings: no deterioration of the body which renders the large packaging unsafe for transport and no loss of contents.

6.6.5.3.4 **Drop test**

6.6.5.3.4.1 *Applicability*

For all types of large packaging, as a design type test.

6.6.5.3.4.2 *Preparation of large packaging for testing*

The large packaging shall be filled in accordance with 6.6.5.2.1.

6.6.5.3.4.3 *Method of testing*

The large packaging shall be dropped onto a non-resilient, horizontal, flat, massive and rigid surface in conformity with the requirements of 6.1.5.3.4, in such a manner as to ensure that the point of impact is that part of the base of the large packaging considered to be the most vulnerable.

6.6.5.3.4.4 *Drop height*

**Note:** Large packagings for substances and articles of class 1 shall be tested at the packing group II performance level.

6.6.5.3.4.4.1 For inner packagings containing solid or liquid substances or articles, if the test is performed with the solid, liquid or articles to be transported, or with another substance or article having essentially the same characteristics:

| Packing group I | Packing group II | Packing group III |
|-----------------|------------------|-------------------|
| 1.8 m           | 1.2 m            | 0.8 m             |

6.6.5.3.4.4.2 For inner packagings containing liquids if the test is performed with water:

(a) Where the substances to be transported have a relative density not exceeding 1.2:

| Packing group I | Packing group II | Packing group III |
|-----------------|------------------|-------------------|
| 1.8 m           | 1.2 m            | 0.8 m             |

(b) Where the substances to be transported have a relative density exceeding 1.2, the drop height shall be calculated on the basis of the relative density (*d*) of the substance to be carried, rounded up to the first decimal, as follows:

| Packing group I  | Packing group II | Packing group III |
|------------------|------------------|-------------------|
| $d \times 1.5$ m | $d \times 1.0$ m | $d \times 0.67$ m |



**6.6.5.3.4.5** *Criteria for passing the test*

- 6.6.5.3.4.5.1** The large packaging shall not exhibit any damage liable to affect safety during transport. There shall be no leakage of the filling substance from inner packaging(s) or article(s).
- 6.6.5.3.4.5.2** No rupture is permitted in a large packaging for articles of class 1 which would permit the spillage of loose explosive substances or articles from the large packaging.
- 6.6.5.3.4.5.3** Where a large packaging undergoes a drop test, the sample passes the test if the entire contents are retained even if the closure is no longer sift-proof.

**6.6.5.4** **Certification and test report**

- 6.6.5.4.1** In respect of each design type of large packaging, a certificate and mark (as in 6.6.3) shall be issued attesting that the design type, including its equipment, meets the test provisions.
- 6.6.5.4.2** A test report containing at least the following particulars shall be drawn up and shall be available to the users of the large packaging:
- .1 name and address of the test facility;
  - .2 name and address of applicant (where appropriate);
  - .3 a unique test report identification;
  - .4 date of the test report;
  - .5 manufacturer of the large packaging;
  - .6 description of the large packaging design type (such as dimensions, materials, closures, thickness, etc.) and/or photograph(s);
  - .7 maximum capacity/maximum permissible gross mass;
  - .8 characteristics of test contents, such as types and descriptions of inner packaging or articles used;
  - .9 test descriptions and results;
  - .10 the test report shall be signed with the name and status of the signatory.
- 6.6.5.4.3** The test report shall contain statements that the large packaging prepared as for transport was tested in accordance with the appropriate provisions of this chapter and that the use of other packaging methods or components may render it invalid. A copy of the test report shall be available to the competent authority.

## Chapter 6.7

### *Provisions for the design, construction, inspection and testing of portable tanks and multiple-element gas containers (MEGCs)*

**Note 1:** The provisions of this chapter also apply to road tank vehicles to the extent indicated in chapter 6.8.

**Note 2:** The provisions of this chapter also apply to portable tanks with shells made of fibre-reinforced plastics (FRP) to the extent indicated in chapter 6.10.

#### 6.7.1 Application and general provisions

6.7.1.1 The provisions of this chapter apply to portable tanks intended for the transport of dangerous goods, and to MEGCs intended for the transport of non-refrigerated gases of class 2, by all modes of transport. In addition to the provisions of this chapter, unless otherwise specified, the applicable provisions of the *International Convention for Safe Containers, 1972* (CSC Convention), as amended, shall be fulfilled by any multimodal portable tank or MEGC which meets the definition of a “container” within the terms of that Convention. Additional provisions may apply to offshore portable tanks that are handled in open seas.

6.7.1.1.1 The *International Convention for Safe Containers, 1972* (CSC Convention) does not apply to offshore tank-containers that are handled in open seas. The design and testing of offshore tank-containers shall take into account the dynamic lifting and impact forces that may occur when a tank is handled in open seas in adverse weather and sea conditions. The provisions for such tanks shall be determined by the approving competent authority (see also *Guidelines for the approval of offshore containers handled in open seas* (MSC/Circ.860)).

6.7.1.2 In recognition of scientific and technological advances, the technical provisions of this chapter may be varied by alternative arrangements. These alternative arrangements shall offer a level of safety not less than that given by the provisions of this chapter with respect to the compatibility with substances transported and the ability of the portable tank to withstand impact, loading and fire conditions. For international transport, alternative arrangement portable tanks or MEGCs shall be approved by the applicable competent authorities.

6.7.1.3 When a substance is not assigned a portable tank instruction (T1 to T75) in the Dangerous Goods List in chapter 3.2, interim approval for transport may be issued by the competent authority of the country of origin. The approval shall be included in the documentation of the consignment and contain, as a minimum, the information normally provided in the portable tank instructions and the conditions under which the substance shall be transported. Appropriate measures shall be initiated by the competent authority to include the assignment in the Dangerous Goods List.

#### 6.7.2 Provisions for the design, construction, inspection and testing of portable tanks intended for the transport of substances of class 1 and classes 3 to 9

##### 6.7.2.1 Definitions

For the purposes of this section:

*Design pressure* means the pressure to be used in calculations required by a recognized pressure-vessel code. The design pressure shall be not less than the highest of the following pressures:

- .1 the maximum effective gauge pressure allowed in the shell during filling or discharge; or
- .2 the sum of:
  - .1 the absolute vapour pressure (in bar) of the substance at 65°C (or at the highest temperature during filling, discharge or transport for substances which are filled, discharged or transported over 65°C), minus 1 bar;
  - .2 the partial pressure (in bar) of air or other gases in the ullage space, being determined by a maximum ullage temperature of 65°C and a liquid expansion due to an increase in mean bulk temperature of  $t_r - t_f$  ( $t_f$  = filling temperature, usually 15°C;  $t_r$  = 50°C, maximum mean bulk temperature); and

## Chapter 6.7 – Design, construction, inspection and testing of portable tanks &amp; MEGCs

- .3 a head pressure determined on the basis of the static forces specified in 6.7.2.2.12, but not less than 0.35 bar; or
- .3 two thirds of the minimum test pressure specified in the applicable portable tank instruction in 4.2.5.2.6;

*Design temperature range* for the shell shall be  $-40^{\circ}\text{C}$  to  $50^{\circ}\text{C}$  for substances transported under ambient conditions. For the other substances filled, discharged or transported above  $50^{\circ}\text{C}$ , the design temperature shall not be less than the maximum temperature of the substance during filling, discharge or transport. More severe design temperatures shall be considered for portable tanks subjected to severe climatic conditions;

*Fine grain steel* means steel which has a ferritic grain size of 6 or finer when determined in accordance with ASTM E 112-96 or as defined in EN 10028-3, Part 3;

*Fusible element* means a non-reclosable pressure relief device that is thermally actuated;

*Leakproofness test* means a test using gas, subjecting the shell and its service equipment to an effective internal pressure of not less than 25% of the MAWP;

*Maximum allowable working pressure (MAWP)* means a pressure that shall be not less than the highest of the following pressures measured at the top of the shell while in operating position:

- .1 the maximum effective gauge pressure allowed in the shell during filling or discharge; or
- .2 the maximum effective gauge pressure to which the shell is designed, which shall be not less than the sum of:
  - .1 the absolute vapour pressure (in bar) of the substance at  $65^{\circ}\text{C}$  (or at the highest temperature during filling, discharge or transport for substances which are filled, discharged or transported over  $65^{\circ}\text{C}$ ) minus 1 bar; and
  - .2 the partial pressure (in bar) of air or other gases in the ullage space, being determined by a maximum ullage temperature of  $65^{\circ}\text{C}$  and a liquid expansion due to an increase in mean bulk temperature of  $t_r - t_f$  ( $t_f$  = filling temperature, usually  $15^{\circ}\text{C}$ ;  $t_r$  =  $50^{\circ}\text{C}$ , maximum mean bulk temperature);

*Maximum permissible gross mass (MPGM)* means the sum of the tare mass of the portable tank and the heaviest load authorized for transport;

*Mild steel* means a steel with a guaranteed minimum tensile strength of  $360\text{ N/mm}^2$  to  $440\text{ N/mm}^2$  and a guaranteed minimum elongation at fracture conforming to 6.7.2.3.3.3;

*Offshore portable tank* means a portable tank specially designed for repeated use for transport of dangerous goods to, from and between offshore facilities. An offshore portable tank is designed and constructed in accordance with the *Guidelines for the approval of offshore containers handled in open seas* (MSC/Circ.860).

*Portable tank* means a multimodal tank used for the transport of substances of class 1 and classes 3 to 9. The portable tank includes a shell fitted with service equipment and structural equipment necessary for the transport of dangerous substances. The portable tank shall be capable of being filled and discharged without the removal of its structural equipment. It shall possess stabilizing members external to the shell, and shall be capable of being lifted when full. It shall be designed primarily to be loaded onto a vehicle or ship and shall be equipped with skids, mountings or accessories to facilitate mechanical handling. Road tank-vehicles, rail tank-wagons, non-metallic tanks (except FRP portable tanks, see chapter 6.10), gas cylinders, large receptacles, and intermediate bulk containers (IBCs) are not considered to fall within this definition;

*Reference steel* means a steel with a tensile strength of  $370\text{ N/mm}^2$  and an elongation at fracture of 27%;

*Service equipment* means measuring instruments and filling, discharge, venting, safety, heating, cooling and insulating devices;

*Shell* means the part of the portable tank which retains the substance intended for transport (tank proper), including openings and their closures, but does not include service equipment or external structural equipment;

*Structural equipment* means the reinforcing, fastening, protective and stabilizing members external to the shell;

*Test pressure* means the maximum gauge pressure at the top of the shell during the hydraulic pressure test, equal to not less than 1.5 times the design pressure. The minimum test pressure for portable tanks intended for specific substances is specified in the applicable portable tank instruction in 4.2.5.2.6.

### 6.7.2.2 General design and construction provisions

- 6.7.2.2.1 Shells shall be designed and constructed in accordance with the provisions of a pressure-vessel code recognized by the competent authority. Shells shall be made of metallic materials suitable for forming. The materials shall, in principle, conform to national or international material standards. For welded shells, only a material whose weldability has been fully demonstrated shall be used. Welds shall be skillfully made and

**Part 6 – Construction and testing of packagings, IBCs, etc.**

afford complete safety. When the manufacturing process or the materials make it necessary, the shells shall be suitably heat-treated to guarantee adequate toughness in the weld and in the heat-affected zones. In choosing the material, the design temperature range shall be taken into account with respect to risk of brittle fracture, to stress corrosion cracking and to resistance to impact. When fine grain-steel is used, the guaranteed value of the yield strength shall be not more than 460 N/mm<sup>2</sup> and the guaranteed value of the upper limit of the tensile strength shall be not more than 725 N/mm<sup>2</sup> according to the material specification. Aluminium may only be used as a construction material when indicated in a portable tank special provision assigned to a specific substance in the Dangerous Goods List or when approved by the competent authority. When aluminium is authorized, it shall be insulated to prevent significant loss of physical properties when subjected to a heat load of 110 kW/m<sup>2</sup> for a period of not less than 30 minutes. The insulation shall remain effective at all temperatures less than 649°C and shall be jacketed with a material with a melting point of not less than 700°C. Portable tank materials shall be suitable for the external environment in which they may be transported.

- 6.7.2.2.2 Portable tank shells, fittings, and pipework shall be constructed from materials which are:
- .1 substantially immune to attack by the substance(s) intended to be transported; or
  - .2 properly passivated or neutralized by chemical reaction; or
  - .3 lined with corrosion-resistant material directly bonded to the shell or attached by equivalent means.
- 6.7.2.2.3 Gaskets shall be made of materials not subject to attack by the substance(s) intended to be transported.
- 6.7.2.2.4 When shells are lined, the lining shall be substantially immune to attack by the substance(s) intended to be transported, homogeneous, non-porous, free from perforations, sufficiently elastic and compatible with the thermal expansion characteristics of the shell. The lining of every shell, shell fittings and piping shall be continuous, and shall extend around the face of any flange. Where external fittings are welded to the tank, the lining shall be continuous through the fitting and around the face of external flanges.
- 6.7.2.2.5 Joints and seams in the lining shall be made by fusing the material together or by other equally effective means.
- 6.7.2.2.6 Contact between dissimilar metals which could result in damage by galvanic action shall be avoided.
- 6.7.2.2.7 The materials of the portable tank, including any devices, gaskets, linings and accessories, shall not adversely affect the substance(s) intended to be transported in the portable tank.
- 6.7.2.2.8 Portable tanks shall be designed and constructed with supports to provide a secure base during transport and with suitable lifting and tie-down attachments.
- 6.7.2.2.9 Portable tanks shall be designed to withstand, without loss of contents, at least the internal pressure due to the contents and the static, dynamic and thermal loads during normal conditions of handling and transport. The design shall demonstrate that the effects of fatigue, caused by repeated application of these loads through the expected life of the portable tank, have been taken into account.
- 6.7.2.2.9.1 For portable tanks that are intended for use as offshore tank-containers, the dynamic stresses imposed by handling in open seas shall be taken into account.
- 6.7.2.2.10 A shell which is to be equipped with a vacuum-relief device shall be designed to withstand, without permanent deformation, an external pressure of not less than 0.21 bar above the internal pressure. The vacuum-relief device shall be set to relieve at a vacuum setting not greater than –0.21 bar unless the shell is designed for a higher external overpressure, in which case the vacuum-relief pressure of the device to be fitted shall be not greater than the tank design vacuum pressure. A shell used for the transport of solid substances of packing groups II or III only which do not liquefy during transport may be designed for a lower external pressure, subject to competent authority's approval. In this case, the vacuum-relief device shall be set to relieve at this lower pressure. A shell that is not to be fitted with a vacuum-relief device shall be designed to withstand, without permanent deformation, an external pressure of not less than 0.4 bar above the internal pressure.
- 6.7.2.2.11 Vacuum-relief devices used on portable tanks intended for the transport of substances meeting the flashpoint criteria of class 3, including elevated-temperature substances transported at or above their flashpoint, shall prevent the immediate passage of flame into the shell, or the portable tank shall have a shell capable of withstanding, without leakage, an internal explosion resulting from the passage of flame into the shell.
- 6.7.2.2.12 Portable tanks and their fastenings shall, under the maximum permissible load, be capable of absorbing the following separately applied static forces:
- .1 in the direction of travel: twice the MPGM multiplied by the acceleration due to gravity (g);\*
  - .2 horizontally at right angles to the direction of travel: the MPGM (when the direction of travel is not clearly determined, the forces shall be equal to twice the MPGM) multiplied by the acceleration due to gravity (g);\*

\* For calculation purposes,  $g = 9.81 \text{ m/s}^2$ .

## Chapter 6.7 – Design, construction, inspection and testing of portable tanks &amp; MEGCs

- .3 vertically upwards: the MPGM multiplied by the acceleration due to gravity (g);\* and
- .4 vertically downwards: twice the MPGM (total loading including the effect of gravity) multiplied by the acceleration due to gravity (g).\*
- 6.7.2.2.13** Under each of the forces in 6.7.2.2.12, the safety factor to be observed shall be as follows:
- .1 for metals having a clearly defined yield point, a safety factor of 1.5 in relation to the guaranteed yield strength; or
- .2 for metals with no clearly defined yield point, a safety factor of 1.5 in relation to the guaranteed 0.2% proof strength and, for austenitic steels, the 1% proof strength.
- 6.7.2.2.14** The value of yield strength or proof strength shall be the value according to national or international material standards. When austenitic steels are used, the specified minimum values of yield strength or proof strength according to the material standards may be increased by up to 15% when these greater values are attested in the material inspection certificate. When no material standard exists for the metal in question, the value of yield strength or proof strength used shall be approved by the competent authority.
- 6.7.2.2.15** Portable tanks shall be capable of being electrically earthed when intended for the transport of substances meeting the flashpoint criteria of class 3, including elevated-temperature substances transported above their flashpoint. Measures shall be taken to prevent dangerous electrostatic discharge.
- 6.7.2.2.16** When required for certain substances by the applicable portable tank instruction indicated in column 13 of the Dangerous Goods List, or by a portable tank special provision indicated in column 14 of the Dangerous Goods List, portable tanks shall be provided with additional protection, which may take the form of additional shell thickness or a higher test pressure, the additional shell thickness or higher test pressure being determined in the light of the inherent risks associated with the transport of the substances concerned.
- 6.7.2.2.17** Thermal insulation directly in contact with the shell intended for substances transported at elevated temperature shall have an ignition temperature at least 50°C higher than the maximum design temperature of the tank.
- 6.7.2.3 Design criteria**
- 6.7.2.3.1** Shells shall be of a design capable of being stress-analysed mathematically or experimentally by resistance strain gauges, or by other methods approved by the competent authority.
- 6.7.2.3.2** Shells shall be designed and constructed to withstand a hydraulic test pressure not less than 1.5 times the design pressure. Specific provisions are laid down for certain substances in the applicable portable tank instruction indicated in column 13 of the Dangerous Goods List and described in 4.2.5.2.6 or by a portable tank special provision indicated in column 14 of the Dangerous Goods List and described in 4.2.5.3. The minimum shell thickness shall not be less than that specified for these tanks in 6.7.2.4.1 to 6.7.2.4.10.
- 6.7.2.3.3** For metals exhibiting a clearly defined yield point or characterized by a guaranteed proof strength (0.2% proof strength, generally, or 1% proof strength for austenitic steels), the primary membrane stress  $\sigma$  (sigma) in the shell shall not exceed  $0.75R_e$  or  $0.50R_m$ , whichever is lower, at the test pressure, where:
- $$R_e = \text{yield strength in N/mm}^2, \text{ or } 0.2\% \text{ proof strength or, for austenitic steels, } 1\% \text{ proof strength;}$$
- $$R_m = \text{minimum tensile strength in N/mm}^2.$$
- 6.7.2.3.3.1** The values of  $R_e$  and  $R_m$  to be used shall be the specified minimum values according to national or international material standards. When austenitic steels are used, the specified minimum values for  $R_e$  and  $R_m$  according to the material standards may be increased by up to 15% when these greater values are attested in the material inspection certificate. When no material standard exists for the metal in question, the values of  $R_e$  and  $R_m$  used shall be approved by the competent authority or its authorized body.
- 6.7.2.3.3.2** Steels which have a  $R_e/R_m$  ratio of more than 0.85 are not allowed for the construction of welded shells. The values of  $R_e$  and  $R_m$  to be used in determining this ratio shall be the values specified in the material inspection certificate.
- 6.7.2.3.3.3** Steels used in the construction of shells shall have an elongation at fracture, in %, of not less than  $10,000/R_m$  with an absolute minimum of 16% for fine-grain steels and 20% for other steels. Aluminium and aluminium alloys used in the construction of shells shall have an elongation at fracture, in %, of not less than  $10,000/6R_m$  with an absolute minimum of 12%.
- 6.7.2.3.3.4** For the purpose of determining actual values for materials, it shall be noted that for sheet metal, the axis of the tensile test specimen shall be at right angles (transversely) to the direction of rolling. The permanent elongation at fracture shall be measured on test specimens of rectangular cross-section in accordance with ISO 6892:1998 using a 50 mm gauge length.

\* For calculation purposes,  $g = 9.81 \text{ m/s}^2$ .



**Part 6 – Construction and testing of packagings, IBCs, etc.****6.7.2.4 Minimum shell thickness**

6.7.2.4.1 The minimum shell thickness shall be the greater thickness based on:

- .1 the minimum thickness determined in accordance with the provisions of 6.7.2.4.2 to 6.7.2.4.10;
- .2 the minimum thickness determined in accordance with the recognized pressure-vessel code, including the provisions in 6.7.2.3; and
- .3 the minimum thickness specified in the applicable portable tank instruction indicated in column 13 of the Dangerous Goods List, or by a portable tank special provision indicated in column 14.

6.7.2.4.2 The cylindrical portions, ends (heads) and manhole covers of shells not more than 1.80 m in diameter shall be not less than 5 mm thick in the reference steel or of equivalent thickness in the metal to be used. Shells more than 1.80 m in diameter shall be not less than 6 mm thick in the reference steel or of equivalent thickness in the metal to be used, except that for powdered or granular solid substances of packing group II or III the minimum thickness requirement may be reduced to not less than 5 mm thick in the reference steel or of equivalent thickness in the metal to be used.

6.7.2.4.3 When additional protection against shell damage is provided, portable tanks with test pressures less than 2.65 bar may have the minimum shell thickness reduced, in proportion to the protection provided, as approved by the competent authority. However, shells not more than 1.80 m in diameter shall be not less than 3 mm thick in the reference steel or of equivalent thickness in the metal to be used. Shells more than 1.80 m in diameter shall be not less than 4 mm thick in the reference steel or of equivalent thickness in the metal to be used.

6.7.2.4.4 The cylindrical portions, ends (heads) and manhole covers of all shells shall be not less than 3 mm thick regardless of the material of construction.

6.7.2.4.5 The additional protection referred to in 6.7.2.4.3 may be provided by overall external structural protection, such as suitable “sandwich” construction with the outer sheathing (jacket) secured to the shell, double-wall construction or by enclosing the shell in a complete framework with longitudinal and transverse structural members.

6.7.2.4.6 The equivalent thickness of a metal other than the thickness prescribed for the reference steel in 6.7.2.4.3 shall be determined using the following equation:

$$e_1 = \frac{21.4 \times e_0}{\sqrt[3]{R_{m1} \times A_1}}$$

where:

- $e_1$  = required equivalent thickness (in mm) of the metal to be used;
- $e_0$  = minimum thickness (in mm) of the reference steel specified in the applicable portable tank instruction or by a portable tank special provision indicated in column 13 or 14 of the Dangerous Goods List;
- $R_{m1}$  = guaranteed minimum tensile strength (in N/mm<sup>2</sup>) of the metal to be used (see 6.7.2.3.3);
- $A_1$  = guaranteed minimum elongation at fracture (in %) of the metal to be used according to national or international standards.

6.7.2.4.7 When, in the applicable portable tank instruction in 4.2.5.2.6, a minimum thickness of 8 mm, 10 mm or 12 mm is specified, it shall be noted that these thicknesses are based on the properties of the reference steel and a shell diameter of 1.80 m. When a metal other than mild steel (see 6.7.2.1) is used or the shell has a diameter of more than 1.80 m, the thickness shall be determined using the following equation:

$$e_1 = \frac{21.4 \times e_0 d_1}{1.8 \sqrt[3]{R_{m1} \times A_1}}$$

where:

- $e_1$  = required equivalent thickness (in mm) of the metal to be used;
- $e_0$  = minimum thickness (in mm) of the reference steel specified in the applicable portable tank instruction or by a portable tank special provision indicated in column 13 or 14 of the Dangerous Goods List;
- $d_1$  = diameter of the shell (in m), but not less than 1.80 m;
- $R_{m1}$  = guaranteed minimum tensile strength (in N/mm<sup>2</sup>) of the metal to be used (see 6.7.2.3.3);
- $A_1$  = guaranteed minimum elongation at fracture (in %) of the metal to be used according to national or international standards.

6.7.2.4.8 In no case shall the wall thickness be less than that prescribed in 6.7.2.4.2, 6.7.2.4.3 and 6.7.2.4.4. All parts of the shell shall have a minimum thickness as determined by 6.7.2.4.2 to 6.7.2.4.4. This thickness shall be exclusive of any corrosion allowance.

6.7.2.4.9 When mild steel is used (see 6.7.2.1), calculation using the equation in 6.7.2.4.6 is not required.

6.7.2.4.10 There shall be no sudden change of plate thickness at the attachment of the ends (heads) to the cylindrical portion of the shell.



## Chapter 6.7 – Design, construction, inspection and testing of portable tanks &amp; MEGCs

**6.7.2.5 Service equipment**

- 6.7.2.5.1** Service equipment shall be so arranged as to be protected against the risk of being wrenched off or damaged during handling and transport. When the connection between the frame and the shell allows relative movement between the sub-assemblies, the equipment shall be so fastened as to permit such movement without risk of damage to working parts. The external discharge fittings (pipe sockets, shut-off devices), the internal stop-valve and its seating shall be protected against the danger of being wrenched off by external forces (for example, by using shear sections). The filling and discharge devices (including flanges or threaded plugs) and any protective caps shall be capable of being secured against unintended opening.
- 6.7.2.5.1.1** For offshore tank-containers, where positioning of service equipment and the design and strength of protection for such equipment is concerned, the increased danger of impact damage when handling such tanks in open seas shall be taken into account.
- 6.7.2.5.2** All openings in the shell, intended for filling or discharging the portable tank, shall be fitted with a manually operated stop-valve located as close to the shell as reasonably practicable. Other openings, except for openings leading to venting or pressure relief devices, shall be equipped with either a stop-valve or another suitable means of closure located as close to the shell as reasonably practicable.
- 6.7.2.5.3** All portable tanks shall be fitted with a manhole or other inspection openings of a suitable size to allow for internal inspection and adequate access for maintenance and repair of the interior. Compartmented portable tanks shall have a manhole or other inspection openings for each compartment.
- 6.7.2.5.4** As far as reasonably practicable, external fittings shall be grouped together. For insulated portable tanks, top fittings shall be surrounded by a spill-collection reservoir with suitable drains.
- 6.7.2.5.5** Each connection to a portable tank shall be clearly marked to indicate its function.
- 6.7.2.5.6** Each stop-valve or other means of closure shall be designed and constructed to a rated pressure not less than the MAWP of the shell, taking into account the temperatures expected during transport. All stop-valves with screwed spindles shall close by a clockwise motion of the handwheel. For other stop-valves, the position (open and closed) and direction of closure shall be clearly indicated. All stop-valves shall be designed to prevent unintentional opening.
- 6.7.2.5.7** No moving parts, such as covers, components of closures, etc., shall be made of unprotected corrodible steel when they are liable to come into frictional or percussive contact with aluminium portable tanks intended for the transport of substances meeting the flashpoint criteria of class 3, including elevated-temperature substances transported above their flashpoint.
- 6.7.2.5.8** Piping shall be designed, constructed and installed so as to avoid the risk of damage due to thermal expansion and contraction, mechanical shock and vibration. All piping shall be of a suitable metallic material. Welded pipe joints shall be used wherever possible.
- 6.7.2.5.9** Joints in copper tubing shall be brazed or have an equally strong metal union. The melting point of brazing materials shall be no lower than 525°C. The joints shall not decrease the strength of the tubing, as may happen when cutting threads.
- 6.7.2.5.10** The burst pressure of all piping and pipe fittings shall be not less than the highest of four times the MAWP of the shell or four times the pressure to which it may be subjected in service by the action of a pump or other device (except pressure relief devices).
- 6.7.2.5.11** Ductile metals shall be used in the construction of valves and accessories.
- 6.7.2.5.12** The heating system shall be designed or controlled so that a substance cannot reach a temperature at which the pressure in the tank exceeds its MAWP or causes other hazards (e.g. dangerous thermal decomposition).
- 6.7.2.5.13** The heating system shall be designed or controlled so that power for internal heating elements is not available unless the heating elements are completely submerged. The temperature at the surface of the heating elements for internal heating equipment or the temperature at the shell for external heating equipment shall, in no case, exceed 80% of the auto-ignition temperature (in °C) of the substances carried.
- 6.7.2.5.14** If an electrical heating system is installed inside the tank, it shall be equipped with an earth leakage circuit breaker with a releasing current of less than 100 mA.
- 6.7.2.5.15** Electrical switch cabinets mounted to tanks shall not have a direct connection to the tank interior and shall provide protection of at least the equivalent of IP 56 according to IEC 144 or IEC 529.

**6.7.2.6 Bottom openings**

- 6.7.2.6.1** Certain substances shall not be transported in portable tanks with bottom openings. When the applicable portable tank instruction identified in the Dangerous Goods List and described in 4.2.5.2.6 indicates that bottom openings are prohibited, there shall be no openings below the liquid level of the shell when it is filled

**Part 6 – Construction and testing of packagings, IBCs, etc.**

to its maximum permissible filling limit. When an existing opening is closed, it shall be accomplished by internally and externally welding one plate to the shell.

**6.7.2.6.2** Bottom discharge outlets for portable tanks carrying certain solid, crystallizable or highly viscous substances shall be equipped with not less than two serially fitted and mutually independent shut-off devices. The design of the equipment shall be to the satisfaction of the competent authority or its authorized body and shall include:

- .1 an external stop-valve, fitted as close to the shell as reasonably practicable, and so designed as to prevent any unintended opening through impact or other inadvertent act; and
- .2 a liquid-tight closure at the end of the discharge pipe, which may be a bolted blank flange or a screw cap.

**6.7.2.6.3** Every bottom discharge outlet, except as provided in 6.7.2.6.2, shall be equipped with three serially fitted and mutually independent shut-off devices. The design of the equipment shall be to the satisfaction of the competent authority or its authorized body and include:

- .1 a self-closing internal stop-valve, that is a stop-valve within the shell or within a welded flange or its companion flange, such that:
  - .1 the control devices for the operation of the valve are designed so as to prevent any unintended opening through impact or other inadvertent act;
  - .2 the valve may be operable from above or below;
  - .3 if possible, the setting of the valve (open or closed) shall be capable of being verified from the ground;
  - .4 except for portable tanks having a capacity of not more than 1000 L, it shall be possible to close the valve from an accessible position of the portable tank that is remote from the valve itself; and
  - .5 the valve shall continue to be effective in the event of damage to the external device for controlling the operation of the valve;
- .2 an external stop-valve fitted as close to the shell as reasonably practicable; and
- .3 a liquid-tight closure at the end of the discharge pipe, which may be a bolted blank flange or a screw cap.

**6.7.2.6.4** For a lined shell, the internal stop-valve required by 6.7.2.6.3.1 may be replaced by an additional external stop-valve. The manufacturer shall satisfy the provisions of the competent authority or its authorized body.

**6.7.2.7 Safety relief devices**

**6.7.2.7.1** All portable tanks shall be fitted with at least one pressure relief device. All relief devices shall be designed, constructed and marked to the satisfaction of the competent authority or its authorized body.

**6.7.2.8 Pressure relief devices**

**6.7.2.8.1** Every portable tank with a capacity not less than 1900 L and every independent compartment of a portable tank with a similar capacity shall be provided with one or more pressure relief devices of the spring-loaded type and may in addition have a frangible disc or fusible element in parallel with the spring-loaded devices except when prohibited by reference to 6.7.2.8.3 in the applicable portable tank instruction in 4.2.5.2.6. The pressure relief devices shall have sufficient capacity to prevent rupture of the shell due to over-pressurization or vacuum resulting from filling, from discharging, or from heating of the contents.

**6.7.2.8.2** Pressure relief devices shall be designed to prevent the entry of foreign matter, the leakage of liquid and the development of any dangerous excess pressure.

**6.7.2.8.3** When required for certain substances by the applicable portable tank instruction identified in the Dangerous Goods List and described in 4.2.5.2.6, portable tanks shall have a pressure relief device approved by the competent authority. Unless a portable tank in dedicated service is fitted with an approved relief device constructed of materials compatible with the load, the relief device shall comprise a frangible disc preceding a spring-loaded pressure relief device. When a frangible disc is inserted in series with the required pressure relief device, the space between the frangible disc and the pressure relief device shall be provided with a pressure gauge or suitable tell-tale indicator for the detection of disc rupture, pinholing, or leakage which could cause a malfunction of the pressure relief system. The frangible disc shall rupture at a nominal pressure 10% above the start-to-discharge pressure of the relief device.

**6.7.2.8.4** Every portable tank with a capacity less than 1900 L shall be fitted with a pressure relief device, which may be a frangible disc when this disc complies with the provisions of 6.7.2.11.1. When no spring-loaded pressure relief device is used, the frangible disc shall be set to rupture at a nominal pressure equal to the test pressure. In addition, fusible elements conforming to 6.7.2.10.1 may also be used.

**6.7.2.8.5** When the shell is fitted for pressure discharge, the inlet line shall be provided with a suitable pressure relief device set to operate at a pressure not higher than the MAWP of the shell, and a stop-valve shall be fitted as close to the shell as reasonably practicable.

Chapter 6.7 – Design, construction, inspection and testing of portable tanks & MEGCs

**6.7.2.9 Setting of pressure relief devices**

**6.7.2.9.1** It shall be noted that the pressure relief devices shall operate only in conditions of excessive rise in temperature, since the shell shall not be subject to undue fluctuations of pressure during normal conditions of transport (see 6.7.2.12.2).

**6.7.2.9.2** The required pressure relief device shall be set to start to discharge at a nominal pressure of five sixths of the test pressure for shells having a test pressure of not more than 4.5 bar and 110% of two thirds of the test pressure for shells having a test pressure of more than 4.5 bar. After discharge, the device shall close at a pressure not more than 10% below the pressure at which the discharge starts. The device shall remain closed at all lower pressures. This requirement does not prevent the use of vacuum relief or combination pressure relief and vacuum relief devices.

**6.7.2.10 Fusible elements**

**6.7.2.10.1** Fusible elements shall operate at a temperature between 100°C and 149°C on condition that the pressure in the shell at the fusing temperature will be not more than the test pressure. They shall be placed at the top of the shell with their inlets in the vapour space, and when used for transport safety purposes, they shall not be shielded from external heat. Fusible elements shall not be used on portable tanks with a test pressure which exceeds 2.65 bar unless specified by special provision TP36 in column 14 of the Dangerous Goods List of chapter 3.2. Fusible elements used on portable tanks intended for the transport of elevated-temperature substances shall be designed to operate at a temperature higher than the maximum temperature that will be experienced during transport and shall be to the satisfaction of the competent authority or its authorized body.

**6.7.2.11 Frangible discs**

**6.7.2.11.1** Except as specified in 6.7.2.8.3, frangible discs shall be set to rupture at a nominal pressure equal to the test pressure throughout the design temperature range. Particular attention shall be given to the provisions of 6.7.2.5.1 and 6.7.2.8.3 if frangible discs are used.

**6.7.2.11.2** Frangible discs shall be appropriate for the vacuum pressures which may be produced in the portable tank.

**6.7.2.12 Capacity of pressure relief devices**

**6.7.2.12.1** The spring-loaded pressure relief device required by 6.7.2.8.1 shall have a minimum cross-sectional flow area equivalent to an orifice of 31.75 mm diameter. Vacuum relief devices, when used, shall have a cross-sectional flow area not less than 284 mm<sup>2</sup>.

**6.7.2.12.2** The combined delivery capacity of the pressure relief system (taking into account the reduction of the flow when the portable tank is fitted with frangible discs preceding spring-loaded pressure relief devices or when the spring-loaded pressure relief devices are provided with a device to prevent the passage of the flame), in conditions of complete fire engulfment of the portable tank shall be sufficient to limit the pressure in the shell to 20% above the start-to-discharge pressure of the pressure-limiting device. Emergency pressure relief devices may be used to achieve the full relief capacity prescribed. These devices may be fusible, spring-loaded or frangible disc components, or a combination of spring-loaded and frangible disc devices. The total required capacity of the relief devices may be determined using the formula in 6.7.2.12.2.1 or the table in 6.7.2.12.2.3.

**6.7.2.12.2.1** To determine the total required capacity of the relief devices, which shall be regarded as being the sum of the individual capacities of all the contributing devices, the following formula shall be used:

$$Q = 12.4 \frac{FA^{0.82}}{LC} \sqrt{\frac{ZT}{M}}$$

where:

**Q** = minimum required rate of discharge in cubic metres of air per second (m<sup>3</sup>/s) at standard conditions: 1 bar and 0°C (273 K);

**F** = a coefficient with the following value:

for uninsulated shells,  $F = 1$

for insulated shells,  $F = U(649 - t)/13.6$  but in no case is less than 0.25

where:

$\Delta U$  = heat transfer coefficient of the insulation, in kW·m<sup>-2</sup>·K<sup>-1</sup>, at 38°C;

**t** = actual temperature of the substance during filling (in °C) (when this temperature is unknown, let  $t = 15^\circ\text{C}$ );

The value of **F** given above for insulated shells may be taken provided that the insulation is in conformance with 6.7.2.12.2.4;

Part 6 – Construction and testing of packagings, IBCs, etc.

- A = total external surface area of shell in square metres;
- Z = the gas compressibility factor in the accumulating condition (when this factor is unknown, let Z equal 1.0);
- T = absolute temperature in kelvin (°C + 273) above the pressure relief devices in the accumulating condition;
- L = the latent heat of vaporization of the liquid, in kJ/kg, in the accumulating condition;
- M = molecular mass of the discharged gas;
- C = a constant which is derived from one of the following formulae as a function of the ratio *k* of specific heats:

$$k = \frac{C_p}{C_v}$$

where:

$C_p$  = specific heat at constant pressure; and

$C_v$  = specific heat at constant volume.

When  $k > 1$ :

$$C = \sqrt{k \left( \frac{2}{k+1} \right)^{\frac{k+1}{k-1}}}$$

When  $k = 1$  or  $k$  is unknown:

$$C = \frac{1}{\sqrt{e}} = 0.607$$

where *e* is the mathematical constant 2.7183.

C may also be taken from the following table:

| <i>k</i> | C     | <i>k</i> | C     | <i>k</i> | C     |
|----------|-------|----------|-------|----------|-------|
| 1.00     | 0.607 | 1.26     | 0.660 | 1.52     | 0.704 |
| 1.02     | 0.611 | 1.28     | 0.664 | 1.54     | 0.707 |
| 1.04     | 0.615 | 1.30     | 0.667 | 1.56     | 0.71  |
| 1.06     | 0.620 | 1.32     | 0.671 | 1.58     | 0.713 |
| 1.08     | 0.624 | 1.34     | 0.674 | 1.60     | 0.716 |
| 1.10     | 0.628 | 1.36     | 0.678 | 1.62     | 0.719 |
| 1.12     | 0.633 | 1.38     | 0.681 | 1.64     | 0.722 |
| 1.14     | 0.637 | 1.40     | 0.685 | 1.66     | 0.725 |
| 1.16     | 0.641 | 1.42     | 0.688 | 1.68     | 0.728 |
| 1.18     | 0.645 | 1.44     | 0.691 | 1.70     | 0.731 |
| 1.20     | 0.649 | 1.46     | 0.695 | 2.0      | 0.77  |
| 1.22     | 0.652 | 1.48     | 0.698 | 2.2      | 0.793 |
| 1.24     | 0.656 | 1.50     | 0.701 |          |       |

6.7.2.12.2.2 As an alternative to the formula above, shells designed for the transport of liquids may have their relief devices sized in accordance with the table in 6.7.2.12.2.3. This table assumes an insulation value of  $F = 1$  and shall be adjusted accordingly when the shell is insulated. Other values used in determining this table are:

$$M = 86.7; \quad T = 394 \text{ K}; \quad L = 334.94 \text{ kJ/kg}; \quad C = 0.607; \quad Z = 1$$

6.7.2.12.2.3 Minimum required rate of discharge, *Q*, in cubic metres of air per second at 1 bar and 0°C (273 K):

| A<br>Exposed area<br>(square metres) | Q<br>(cubic metres of<br>air per second) | A<br>Exposed area<br>(square metres) | Q<br>(cubic metres of<br>air per second) |
|--------------------------------------|--|--------------------------------------|--|
| 2                                    | 0.230                                    | 14                                   | 1.132                                    |
| 3                                    | 0.320                                    | 16                                   | 1.263                                    |
| 4                                    | 0.405                                    | 18                                   | 1.391                                    |
| 5                                    | 0.487                                    | 20                                   | 1.517                                    |
| 6                                    | 0.565                                    | 22.5                                 | 1.670                                    |
| 7                                    | 0.641                                    | 25                                   | 1.821                                    |
| 8                                    | 0.715                                    | 27.5                                 | 1.969                                    |
| 9                                    | 0.788                                    | 30                                   | 2.115                                    |
| 10                                   | 0.859                                    | 32.5                                 | 2.258                                    |
| 12                                   | 0.998                                    | 35                                   | 2.400                                    |



| A<br>Exposed area<br>(square metres) | Q<br>(cubic metres of<br>air per second) | A<br>Exposed area<br>(square metres) | Q<br>(cubic metres of<br>air per second) |
|--------------------------------------|--|--------------------------------------|--|
| 37.5                                 | 2.539                                    | 62.5                                 | 3.860                                    |
| 40                                   | 2.677                                    | 65                                   | 3.987                                    |
| 42.5                                 | 2.814                                    | 67.5                                 | 4.112                                    |
| 45                                   | 2.949                                    | 70                                   | 4.236                                    |
| 47.5                                 | 3.082                                    | 75                                   | 4.483                                    |
| 50                                   | 3.215                                    | 80                                   | 4.726                                    |
| 52.5                                 | 3.346                                    | 85                                   | 4.967                                    |
| 55                                   | 3.476                                    | 90                                   | 5.206                                    |
| 57.5                                 | 3.605                                    | 95                                   | 5.442                                    |
| 60                                   | 3.733                                    | 100                                  | 5.676                                    |

6.7.2.12.2.4 Insulation systems, used for the purpose of reducing venting capacity, shall be approved by the competent authority or its authorized body. In all cases, insulation systems approved for this purpose shall:

- (a) remain effective at all temperatures up to 649°C; and
- (b) be jacketed with a material having a melting point of 700°C or greater.

#### 6.7.2.13 Marking of pressure relief devices

6.7.2.13.1 Every pressure relief device shall be clearly and permanently marked with the following:

- .1 the pressure (in bar or kPa) or temperature (in °C) at which it is set to discharge;
- .2 the allowable tolerance at the discharge pressure, for spring-loaded devices;
- .3 the reference temperature corresponding to the rated pressure, for frangible discs;
- .4 the allowable temperature tolerance, for fusible elements;
- .5 the rated flow capacity of the spring-loaded pressure relief devices, frangible discs or fusible elements in standard cubic metres of air per second (m<sup>3</sup>/s); and
- .6 the cross sectional flow areas of the spring-loaded pressure relief devices, frangible discs and fusible elements in mm<sup>2</sup>.

When practicable, the following information shall also be shown:

- .7 the manufacturer's name and relevant catalogue number.

6.7.2.13.2 The rated flow capacity marked on the spring-loaded pressure relief devices shall be determined according to ISO 4126-1:2004 and ISO 4126-7:2004.

#### 6.7.2.14 Connections to pressure relief devices

6.7.2.14.1 Connections to pressure relief devices shall be of sufficient size to enable the required discharge to pass unrestricted to the safety device. No stop-valve shall be installed between the shell and the pressure relief devices except where duplicate devices are provided for maintenance or other reasons and the stop-valves serving the devices actually in use are locked open or the stop-valves are interlocked so that at least one of the duplicate devices is always in use. There shall be no obstruction in an opening leading to a vent or pressure relief device which might restrict or cut off the flow from the shell to that device. Vents or pipes from the pressure relief device outlets, when used, shall deliver the relieved vapour or liquid to the atmosphere in conditions of minimum back-pressure on the relieving devices.

#### 6.7.2.15 Siting of pressure relief devices

6.7.2.15.1 Each pressure relief device inlet shall be situated on top of the shell in a position as near the longitudinal and transverse centre of the shell as reasonably practicable. All pressure relief device inlets shall, under maximum filling conditions, be situated in the vapour space of the shell and the devices shall be so arranged as to ensure the escaping vapour is discharged unrestrictedly. For flammable substances, the escaping vapour shall be directed away from the shell in such a manner that it cannot impinge upon the shell. Protective devices which deflect the flow of vapour are permissible provided the required relief-device capacity is not reduced.

6.7.2.15.2 Arrangements shall be made to prevent access to the pressure relief devices by unauthorized persons and to protect the devices from damage caused by the portable tank overturning.

**Part 6 – Construction and testing of packagings, IBCs, etc.****6.7.2.16 Gauging devices**

6.7.2.16.1 Glass level-gauges and gauges made of other fragile material, which are in direct communication with the contents of the tank, shall not be used.

**6.7.2.17 Portable tank supports, frameworks, lifting and tie-down attachments**

6.7.2.17.1 Portable tanks shall be designed and constructed with a support structure to provide a secure base during transport. The forces specified in 6.7.2.2.12 and the safety factor specified in 6.7.2.2.13 shall be considered in this aspect of the design. Skids, frameworks, cradles or other similar structures are acceptable.

6.7.2.17.2 The combined stresses caused by portable tank mountings (such as cradles, framework, etc.) and portable tank lifting and tie-down attachments shall not cause excessive stress in any portion of the shell. Permanent lifting and tie-down attachments shall be fitted to all portable tanks. Preferably they shall be fitted to the portable tank supports but may be secured to reinforcing plates located on the shell at the points of support.

6.7.2.17.3 In the design of supports and frameworks, the effects of environmental corrosion shall be taken into account.

6.7.2.17.4 Forklift pockets shall be capable of being closed off. The means of closing forklift pockets shall be a permanent part of the framework or permanently attached to the framework. Single-compartment portable tanks with a length less than 3.65 m need not have closed-off forklift pockets provided that:

- .1 the shell, including all the fittings, is well protected from being hit by the forklift blades; and
- .2 the distance between the centres of the forklift pockets is at least half of the maximum length of the portable tank.

6.7.2.17.5 When portable tanks are not protected during transport, according to 4.2.1.2, the shells and service equipment shall be protected against damage to the shell and service equipment resulting from lateral or longitudinal impact or overturning. External fittings shall be protected so as to preclude the release of the shell contents upon impact or overturning of the portable tank on its fittings. Examples of protection include:

- .1 protection against lateral impact, which may consist of longitudinal bars protecting the shell on both sides at the level of the median line;
- .2 protection of the portable tank against overturning, which may consist of reinforcement rings or bars fixed across the frame;
- .3 protection against rear impact, which may consist of a bumper or frame;
- .4 protection of the shell against damage from impact or overturning by use of an ISO frame in accordance with ISO 1496-3:1995.

**6.7.2.18 Design approval**

6.7.2.18.1 The competent authority or its authorized body shall issue a design approval certificate for any new design of a portable tank. This certificate shall attest that a portable tank has been surveyed by that authority, is suitable for its intended purpose and meets the provisions of this chapter and, where appropriate, the provisions for substances provided in chapter 4.2 and in the Dangerous Goods List in chapter 3.2. When a series of portable tanks are manufactured without change in the design, the certificate shall be valid for the entire series. The certificate shall refer to the prototype test report, the substances or group of substances allowed to be transported, the materials of construction of the shell and lining (when applicable) and an approval number. The approval number shall consist of the distinguishing sign or mark of the State in whose territory the approval was granted, indicated by the distinguishing sign used on vehicles in international road traffic\* and a registration number. Any alternative arrangements according to 6.7.1.2 shall be indicated on the certificate. A design approval may serve for the approval of smaller portable tanks made of materials of the same kind and thickness, by the same fabrication techniques and with identical supports, equivalent closures and other appurtenances.

6.7.2.18.2 The prototype test report for the design approval shall include at least the following:

- .1 the results of the applicable framework test specified in ISO 1496-3:1995;
- .2 the results of the initial inspection and test in 6.7.2.19.3; and
- .3 the results of the impact test in 6.7.2.19.1, when applicable.

**6.7.2.19 Inspection and testing**

6.7.2.19.1 Portable tanks meeting the definition of *container* in the *International Convention for Safe Containers, 1972* (CSC Convention), as amended, shall not be used unless they are successfully qualified by subjecting a representative prototype of each design to the Dynamic, Longitudinal Impact Test prescribed in the *Manual*

\* Distinguishing sign of the State of registration used on motor vehicles and trailers in international road traffic, e.g. in accordance with the Geneva Convention on Road Traffic of 1949 or the Vienna Convention on Road Traffic of 1968.



## Chapter 6.7 – Design, construction, inspection and testing of portable tanks &amp; MEGCs

of *Tests and Criteria*, part IV, section 41. This provision only applies to portable tanks which are constructed according to a design approval certificate which has been issued on or after 1 January 2008.

- 6.7.2.19.2** The shell and items of equipment of each portable tank shall be inspected and tested before being put into service for the first time (initial inspection and test) and thereafter at not more than five-year intervals (5-year periodic inspection and test) with an intermediate periodic inspection and test (2.5-year periodic inspection and test) midway between the 5-year periodic inspections and tests. The 2.5-year periodic inspection and test may be performed within 3 months of the specified date. An exceptional inspection and test shall be performed regardless of the date of the last periodic inspection and test when necessary according to 6.7.2.19.7.
- 6.7.2.19.3** The initial inspection and test of a portable tank shall include a check of the design characteristics, an internal and external examination of the portable tank and its fittings with due regard to the substances to be transported, and a pressure test. Before the portable tank is placed into service, a leakproofness test and a test of the satisfactory operation of all service equipment shall also be performed. When the shell and its fittings have been pressure-tested separately, they shall be subjected together after assembly to a leakproofness test.
- 6.7.2.19.4** The 5-year periodic inspection and test shall include an internal and external examination and, as a general rule, a hydraulic pressure test. For tanks only used for the transport of solid substances other than toxic or corrosive substances, which do not liquefy during transport, the hydraulic pressure test may be replaced by a suitable pressure test at 1.5 times MAWP, subject to competent authority approval. Sheathing, thermal insulation and the like shall be removed only to the extent required for reliable appraisal of the condition of the portable tank. When the shell and equipment have been pressure-tested separately, they shall be subjected together after assembly to a leakproofness test.
- 6.7.2.19.4.1** The heating system shall be subject to inspection and tests including pressure tests on heating coils or ducts during the 5-year periodic inspection.
- 6.7.2.19.5** The intermediate 2.5-year periodic inspection and test shall at least include an internal and external examination of the portable tank and its fittings with due regard to the substances intended to be transported, a leakproofness test and a test of the satisfactory operation of all service equipment. Sheathing, thermal insulation and the like shall be removed only to the extent required for reliable appraisal of the condition of the portable tank. For portable tanks dedicated to the transport of a single substance, the 2.5-year internal examination may be waived or substituted by other test methods or inspection procedures specified by the competent authority or its authorized body.
- 6.7.2.19.6** A portable tank may not be filled and offered for transport after the date of expiry of the last 5-year or 2.5-year periodic inspection and test as required by 6.7.2.19.2. However, a portable tank filled prior to the date of expiry of the last periodic inspection and test may be transported for a period not to exceed three months beyond the date of expiry of the last periodic test or inspection. In addition, a portable tank may be transported after the date of expiry of the last periodic test and inspection:
- .1 after emptying but before cleaning, for purposes of performing the next required test or inspection prior to refilling; and
  - .2 unless otherwise approved by the competent authority, for a period not to exceed six months beyond the date of expiry of the last periodic test or inspection, in order to allow the return of dangerous goods for proper disposal or recycling. Reference to this exemption shall be mentioned in the transport document.
- Except as provided for in this paragraph, portable tanks which have missed the timeframe for their scheduled 5-year or 2.5-year periodic inspection and test may only be filled and offered for transport if a new 5-year periodic inspection and test is performed according to 6.7.2.19.4.
- 6.7.2.19.7** The exceptional inspection and test is necessary when the portable tank shows evidence of damaged or corroded areas, or leakage, or other conditions that indicate a deficiency that could affect the integrity of the portable tank. The extent of the exceptional inspection and test shall depend on the amount of damage or deterioration of the portable tank. It shall include at least the 2.5-year periodic inspection and test according to 6.7.2.19.5.
- 6.7.2.19.8** The internal and external examinations shall ensure that:
- .1 the shell is inspected for pitting, corrosion, or abrasions, dents, distortions, defects in welds or any other conditions, including leakage, that might render the portable tank unsafe for transport. The wall thickness shall be verified by appropriate measurement if this inspection indicates a reduction of wall thickness;
  - .2 the piping, valves, heating/cooling system, and gaskets are inspected for corroded areas, defects, or any other conditions, including leakage, that might render the portable tank unsafe for filling, discharge or transport;
  - .3 devices for tightening manhole covers are operative and there is no leakage at manhole covers or gaskets;
  - .4 missing or loose bolts or nuts on any flanged connection or blank flange are replaced or tightened;



**Part 6 – Construction and testing of packagings, IBCs, etc.**

- .5 all emergency devices and valves are free from corrosion, distortion and any damage or defect that could prevent their normal operation. Remote closure devices and self-closing stop-valves shall be operated to demonstrate proper operation;
- .6 linings, if any, are inspected in accordance with criteria outlined by the lining manufacturer;
- .7 required marks on the portable tank are legible and in accordance with the applicable provisions; and
- .8 the framework, supports and arrangements for lifting the portable tank are in a satisfactory condition.

**6.7.2.19.9** The inspections and tests in 6.7.2.19.1, 6.7.2.19.3, 6.7.2.19.4, 6.7.2.19.5 and 6.7.2.19.7 shall be performed or witnessed by an expert approved by the competent authority or its authorized body. When the pressure test is a part of the inspection and test, the test pressure shall be the one indicated on the data plate of the portable tank. While under pressure, the portable tank shall be inspected for any leaks in the shell, piping or equipment.

**6.7.2.19.10** In all cases when cutting, burning or welding operations on the shell have been effected, that work shall be to the approval of the competent authority or its authorized body, taking into account the pressure-vessel code used for the construction of the shell. A pressure test to the original test pressure shall be performed after the work is completed.

**6.7.2.19.11** When evidence of any unsafe condition is discovered, the portable tank shall not be returned to service until it has been corrected and the test is repeated and passed.

**6.7.2.20 Marking**

**6.7.2.20.1** Every portable tank shall be fitted with a corrosion-resistant metal plate permanently attached to the portable tank in a conspicuous place readily accessible for inspection. When for reasons of portable tank arrangements the plate cannot be permanently attached to the shell, the shell shall be marked with at least the information required by the pressure-vessel code. As a minimum, at least the following information shall be marked on the plate by stamping or by any other similar method:

- (a) Owner information
  - (i) Owner's registration number;
- (b) Manufacturing information
  - (i) Country of manufacture;
  - (ii) Year of manufacture;
  - (iii) Manufacturer's name or mark;
  - (iv) Manufacturer's serial number;
- (c) Approval information
  - (i) The United Nations packaging symbol:



This symbol shall not be used for any purpose other than certifying that a packaging, a flexible bulk container, a portable tank or a MEGC complies with the relevant requirements in chapters 6.1, 6.2, 6.3, 6.5, 6.6, 6.7 or 6.9;

- (ii) Approval country;
- (iii) Authorized body for the design approval;
- (iv) Design approval number;
- (v) Letters "AA", if the design was approved under alternative arrangements (see 6.7.1.2);
- (vi) Pressure-vessel code to which the shell is designed;
- (d) Pressures
  - (i) MAWP (in bar gauge or kPa gauge);\*
  - (ii) Test pressure (in bar gauge or kPa gauge);\*
  - (iii) Initial pressure test date (month and year);
  - (iv) Identification mark of the initial pressure test witness;
  - (v) External design pressure<sup>†</sup> (in bar gauge or kPa gauge);\*
  - (vi) MAWP for heating/cooling system (in bar gauge or kPa gauge)\* (when applicable);
- (e) Temperatures
  - (i) Design temperature range (in °C);\*

\* The unit used shall be indicated.

<sup>†</sup> See 6.7.2.2.10.

Chapter 6.7 – Design, construction, inspection and testing of portable tanks & MEGCs

---

- (f) Materials
  - (i) Shell material(s) and material standard reference(s);
  - (ii) Equivalent thickness in reference steel (in mm);\* and
  - (iii) Lining material (when applicable);
- (g) Capacity
  - (i) Tank water capacity at 20°C (in litres);\*  
This indication is to be followed by the symbol “S” when the shell is divided by surge plates into sections of not more than 7,500 L capacity;
  - (ii) Water capacity of each compartment at 20°C (in litres)\* (when applicable, for multi-compartment tanks).  
This indication is to be followed by the symbol “S” when the compartment is divided by surge plates into sections of not more than 7,500 L capacity;
- (h) Periodic inspections and tests
  - (i) Type of the most recent periodic test (2.5-year, 5-year or exceptional);
  - (ii) Date of the most recent periodic test (month and year);
  - (iii) Test pressure (in bar gauge or kPa gauge)\* of the most recent periodic test (if applicable);
  - (iv) Identification mark of the authorized body who performed or witnessed the most recent test.

---

\* The unit used shall be indicated.

Part 6 – Construction and testing of packagings, IBCs, etc.

Figure 6.7.2.20.1 – Example of a plate for marking

|   |                                     |                |                      |
|---|-------------------------------------|----------------|----------------------|
| Owner's registration number   |                                     |                |                      |
| <b>MANUFACTURING INFORMATION</b>  |                                     |                |                      |
| Country of manufacture  |                                     |                |                      |
| Year of manufacture   |                                     |                |                      |
| Manufacturer  |                                     |                |                      |
| Manufacturer's serial number  |                                     |                |                      |
| <b>APPROVAL INFORMATION</b>   |                                     |                |                      |
|            | Approval country                    |                |                      |
|   | Authorized body for design approval |                |                      |
|   | Design approval number              |                | "AA" (if applicable) |
| Shell design code (pressure-vessel code)  |                                     |                |                      |
| <b>PRESSURES</b>  |                                     |                |                      |
| MAWP  |                                     | bar or kPa     |                      |
| Test pressure   |                                     | bar or kPa     |                      |
| Initial pressure test date:   | (mm/yyyy)                           | Witness stamp: |                      |
| External design pressure  |                                     | bar or kPa     |                      |
| MAWP for heating/cooling system (when applicable)   |                                     | bar or kPa     |                      |
| <b>TEMPERATURES</b>   |                                     |                |                      |
| Design temperature range  |                                     | °C to °C       |                      |
| <b>MATERIALS</b>  |                                     |                |                      |
| Shell material(s) and material standard reference(s)  |                                     |                |                      |
| Equivalent thickness in reference steel   |                                     | mm             |                      |
| Lining material (when applicable)   |                                     |                |                      |
| <b>CAPACITY</b>   |                                     |                |                      |
| Tank water capacity at 20°C   |                                     | litres         | "S" (if applicable)  |
| Water capacity of compartment ___ at 20°C<br>(when applicable, for multi-compartment tanks) |                                     | litres         | "S" (if applicable)  |

| PERIODIC INSPECTIONS/TESTS |           |  |            |           |           |  |            |
|----------------------------|-----------|--|------------|-----------|-----------|--|------------|
| Test type                  | Test date | Witness stamp and test pressure <sup>a</sup> |            | Test type | Test date | Witness stamp and test pressure <sup>a</sup> |            |
|                            | (mm/yyyy) |  | bar or kPa |           | (mm/yyyy) |  | bar or kPa |
|                            |           |  |            |           |           |  |            |
|                            |           |  |            |           |           |  |            |
|                            |           |  |            |           |           |  |            |

<sup>a</sup> Test pressure if applicable.

Chapter 6.7 – Design, construction, inspection and testing of portable tanks & MEGCs

- 6.7.2.20.2 The following information shall be durably marked either on the portable tank itself or on a metal plate firmly secured to the portable tank:
- Name of the operator
  - Maximum permissible gross mass (MPGM) . . . . . kg
  - Unladen (tare) mass . . . . . kg
  - Portable tank instruction in accordance with 4.2.5.2.6.

- 6.7.2.20.3 If a portable tank is designed and approved for handling in open seas, the words “OFFSHORE PORTABLE TANK” shall be marked on the identification plate.

**6.7.3 Provisions for the design, construction, inspection and testing of portable tanks intended for the transport of non-refrigerated liquefied gases of class 2**

**Note:** These requirements also apply to portable tanks intended for the transport of chemicals under pressure (UN Nos. 3500, 3501, 3502, 3503, 3504 and 3505).

**6.7.3.1 Definitions**

For the purposes of this section:

*Design pressure* means the pressure to be used in calculations required by a recognized pressure-vessel code. The design pressure shall be not less than the highest of the following pressures:

- .1 the maximum effective gauge pressure allowed in the shell during filling or discharge; or
- .2 the sum of:
  - .1 the maximum effective gauge pressure to which the shell is designed, as defined in .2 of the MAWP definition (see below); and
  - .2 a head pressure determined on the basis of the static forces specified in 6.7.3.2.9, but not less than 0.35 bar;

*Design reference temperature* means the temperature at which the vapour pressure of the contents is determined for the purpose of calculating the MAWP. The design reference temperature shall be less than the critical temperature of the non-refrigerated liquefied gas or liquefied gas propellants of chemicals under pressure intended to be transported to ensure that the gas at all times is liquefied. This value for each portable tank type is as follows:

- .1 shell with a diameter of 1.5 m or less: 65°C;
- .2 shell with a diameter of more than 1.5 m:
  - .1 without insulation or sunshield: 60°C;
  - .2 with sunshield (see 6.7.3.2.12): 55°C; and
  - .3 with insulation (see 6.7.3.2.12): 50°C;

*Design temperature range* for the shell shall be –40°C to 50°C for non-refrigerated liquefied gases transported under ambient conditions. More severe design temperatures shall be considered for portable tanks subjected to severe climatic conditions;

*Filling density* means the average mass of non-refrigerated liquefied gas per litre of shell capacity (kg/L). The filling density is given in portable tank instruction T50 in 4.2.5.2.6;

*Leakproofness test* means a test using gas subjecting the shell and its service equipment to an effective internal pressure of not less than 25% of the MAWP;

*Maximum allowable working pressure (MAWP)* means a pressure that shall be not less than the highest of the following pressures measured at the top of the shell while in operating position, but in no case less than 7 bar:

- .1 the maximum effective gauge pressure allowed in the shell during filling or discharge; or
- .2 the maximum effective gauge pressure to which the shell is designed, which shall be:
  - .1 for a non-refrigerated liquefied gas listed in the portable tank instruction T50 in 4.2.5.2.6, the MAWP (in bar) given in portable tank instruction T50 for that gas;
  - .2 for other non-refrigerated liquefied gases, not less than the sum of:
    - the absolute vapour pressure (in bar) of the non-refrigerated liquefied gas at the design reference temperature minus 1 bar; and
    - the partial pressure (in bar) of air or other gases in the ullage space, being determined by the design reference temperature and the liquid phase expansion due to an increase of the mean bulk temperature of  $t_r - t_f$  ( $t_f$  = filling temperature, usually 15°C;  $t_r$  = 50°C, maximum mean bulk temperature);



**Part 6 – Construction and testing of packagings, IBCs, etc.**

- .3 for chemicals under pressure, the MAWP (in bar) given in T50 portable tank instruction for the liquefied gas portion of the propellants listed in T50 in 4.2.5.2.6.

*Maximum permissible gross mass (MPGM)* means the sum of the tare mass of the portable tank and the heaviest load authorized for transport;

*Mild steel* means a steel with a guaranteed minimum tensile strength of 360 N/mm<sup>2</sup> to 440 N/mm<sup>2</sup> and a guaranteed minimum elongation at fracture conforming to 6.7.3.3.3.3;

*Portable tank* means a multimodal tank having a capacity of more than 450 L used for the transport of non-refrigerated liquefied gases of class 2. The portable tank includes a shell fitted with service equipment and structural equipment necessary for the transport of gases. The portable tank shall be capable of being filled and discharged without the removal of its structural equipment. It shall possess stabilizing members external to the shell, and shall be capable of being lifted when full. It shall be designed primarily to be loaded onto a transport vehicle or ship and shall be equipped with skids, mountings or accessories to facilitate mechanical handling. Road tank-vehicles, rail tank-wagons, non-metallic tanks, intermediate bulk containers (IBCs), gas cylinders and large receptacles are not considered to fall within the definition for portable tanks;

*Reference steel* means a steel with a tensile strength of 370 N/mm<sup>2</sup> and an elongation at fracture of 27%;

*Service equipment* means measuring instruments and filling, discharge, venting, safety and insulating devices;

*Shell* means the part of the portable tank which retains the non-refrigerated liquefied gas intended for transport (tank proper), including openings and their closures, but does not include service equipment or external structural equipment;

*Structural equipment* means reinforcing, fastening, protective and stabilizing members external to the shell;

*Test pressure* means the maximum gauge pressure at the top of the shell during the pressure test.

**6.7.3.2 General design and construction provisions**

- 6.7.3.2.1** Shells shall be designed and constructed in accordance with the provisions of a pressure-vessel code recognized by the competent authority. Shells shall be made of steel suitable for forming. The materials shall, in principle, conform to national or international material standards. For welded shells, only a material whose weldability has been fully demonstrated shall be used. Welds shall be skilfully made and afford complete safety. When the manufacturing process or the materials make it necessary, the shells shall be suitably heat-treated to guarantee adequate toughness in the weld and in the heat-affected zones. In choosing the material, the design temperature range shall be taken into account with respect to risk of brittle fracture, to stress corrosion cracking and to resistance to impact. When fine-grain steel is used, the guaranteed value of the yield strength shall be not more than 460 N/mm<sup>2</sup> and the guaranteed value of the upper limit of the tensile strength shall be not more than 725 N/mm<sup>2</sup>, according to the material specification. Portable tank materials shall be suitable for the external environment in which they may be transported.
- 6.7.3.2.2** Portable tank shells, fittings and pipework shall be constructed of materials which are:
- .1 substantially immune to attack by the non-refrigerated liquefied gas(es) intended to be transported; or
  - .2 properly passivated or neutralized by chemical reaction.
- 6.7.3.2.3** Gaskets shall be made of materials compatible with the non-refrigerated liquefied gas(es) intended to be transported.
- 6.7.3.2.4** Contact between dissimilar metals which could result in damage by galvanic action shall be avoided.
- 6.7.3.2.5** The materials of the portable tank, including any devices, gaskets, and accessories, shall not adversely affect the non-refrigerated liquefied gas(es) intended for transport in the portable tank.
- 6.7.3.2.6** Portable tanks shall be designed and constructed with supports to provide a secure base during transport and with suitable lifting and tie-down attachments.
- 6.7.3.2.7** Portable tanks shall be designed to withstand, without loss of contents, at least the internal pressure due to the contents and the static, dynamic and thermal loads during normal conditions of handling and transport. The design shall demonstrate that the effects of fatigue, caused by repeated application of these loads through the expected life of the portable tank, have been taken into account.
- 6.7.3.2.7.1** For portable tanks that are intended for use as offshore tank-containers, the dynamic stresses imposed by handling in open seas shall be taken into account.
- 6.7.3.2.8** Shells shall be designed to withstand an external pressure of at least 0.4 bar gauge above the internal pressure without permanent deformation. When the shell is to be subjected to a significant vacuum before filling or during discharge, it shall be designed to withstand an external pressure of at least 0.9 bar gauge above the internal pressure and shall be proven at that pressure.

## Chapter 6.7 – Design, construction, inspection and testing of portable tanks &amp; MEGCs

- 6.7.3.2.9 Portable tanks and their fastenings shall, under the maximum permissible load, be capable of absorbing the following separately applied static forces:
- .1 in the direction of travel: twice the MPGM multiplied by the acceleration due to gravity (g);\*
  - .2 horizontally at right angles to the direction of travel: the MPGM (when the direction of travel is not clearly determined, the forces shall be equal to twice the MPGM) multiplied by the acceleration due to gravity (g);\*
  - .3 vertically upwards: the MPGM multiplied by the acceleration due to gravity (g);\* and
  - .4 vertically downwards: twice the MPGM (total loading including the effect of gravity) multiplied by the acceleration due to gravity (g).\*
- 6.7.3.2.10 Under each of the forces in 6.7.3.2.9, the safety factor to be observed shall be as follows:
- .1 for steels having a clearly defined yield point, a safety factor of 1.5 in relation to the guaranteed yield strength; or
  - .2 for steels with no clearly defined yield point, a safety factor of 1.5 in relation to the guaranteed 0.2% proof strength and, for austenitic steels, the 1% proof strength.
- 6.7.3.2.11 The values of yield strength or proof strength shall be the values according to national or international material standards. When austenitic steels are used, the specified minimum values of yield strength and proof strength according to the material standards may be increased by up to 15% when these greater values are attested in the material inspection certificate. When no material standard exists for the steel in question, the value of yield strength or proof strength used shall be approved by the competent authority.
- 6.7.3.2.12 When the shells intended for the transport of non-refrigerated liquefied gases are equipped with thermal insulation, the thermal insulation system shall satisfy the following provisions:
- .1 It shall consist of a shield covering not less than the upper third but not more than the upper half of the surface of the shell and separated from the shell by an air space about 40 mm across; or
  - .2 It shall consist of a complete cladding of adequate thickness of insulating materials, protected so as to prevent the ingress of moisture and damage under normal conditions of transport and so as to provide a thermal conductance of not more than 0.67 W/m·K;
  - .3 When the protective covering is so closed as to be gas-tight, a device shall be provided to prevent any dangerous pressure from developing in the insulating layer in the event of inadequate gas-tightness of the shell or of its items of equipment;
  - .4 The thermal insulation shall not inhibit access to the fittings and discharge devices.
- 6.7.3.2.13 Portable tanks intended for the transport of flammable non-refrigerated liquefied gases shall be capable of being electrically earthed.
- 6.7.3.3 Design criteria**
- 6.7.3.3.1 Shells shall be of a circular cross-section.
- 6.7.3.3.2 Shells shall be designed and constructed to withstand a test pressure not less than 1.3 times the design pressure. The shell design shall take into account the minimum MAWP values provided in portable tank instruction T50 in 4.2.5.2.6 for each non-refrigerated liquefied gas intended for transport. Attention is drawn to the minimum shell thickness provisions for these shells specified in 6.7.3.4.
- 6.7.3.3.3 For steels exhibiting a clearly defined yield point or characterized by a guaranteed proof strength (0.2% proof strength, generally, or 1% proof strength for austenitic steels), the primary membrane stress  $\sigma$  (sigma) in the shell shall not exceed  $0.75R_e$  or  $0.50R_m$ , whichever is lower, at the test pressure, where:
- $$R_e = \text{yield strength in N/mm}^2, \text{ or } 0.2\% \text{ proof strength or, for austenitic steels, } 1\% \text{ proof strength.}$$
- $$R_m = \text{minimum tensile strength in N/mm}^2.$$
- 6.7.3.3.3.1 The values of  $R_e$  and  $R_m$  to be used shall be the specified minimum values according to national or international material standards. When austenitic steels are used, these specified minimum values for  $R_e$  and  $R_m$  according to the material standards may be increased by up to 15% when these greater values are attested in the material inspection certificate. When no material standard exists for the steel in question, the values of  $R_e$  and  $R_m$  used shall be approved by the competent authority or its authorized body.
- 6.7.3.3.3.2 Steels which have a  $R_e/R_m$  ratio of more than 0.85 are not allowed for the construction of welded shells. The values of  $R_e$  and  $R_m$  to be used in determining this ratio shall be the values specified in the material inspection certificate.
- 6.7.3.3.3.3 Steels used in the construction of shells shall have an elongation at fracture, in %, of not less than  $10,000/R_m$  with an absolute minimum of 16% for fine-grain steels and 20% for other steels.
- 6.7.3.3.3.4 For the purpose of determining actual values for materials, it shall be noted that for sheet metal, the axis of the tensile test specimen shall be at right angles (transversely) to the direction of rolling. The permanent

\* For calculation purposes,  $g = 9.81 \text{ m/s}^2$ .

**Part 6 – Construction and testing of packagings, IBCs, etc.**

elongation at fracture shall be measured on test specimens of rectangular cross-section in accordance with ISO 6892:1998 using a 50 mm gauge length.

**6.7.3.4 Minimum shell thickness**

6.7.3.4.1 The minimum shell thickness shall be the greater thickness based on:

- .1 the minimum thickness determined in accordance with the provisions in 6.7.3.4; and
- .2 the minimum thickness determined in accordance with the recognized pressure-vessel code, including the provisions in 6.7.3.3.

In addition, any relevant portable tank special provision indicated in column 14 of the Dangerous Goods List and described in 4.2.5.3 shall be taken into account.

6.7.3.4.2 The cylindrical portions, ends (heads) and manhole covers of shells of not more than 1.80 m in diameter shall be not less than 5 mm thick in the reference steel or of equivalent thickness in the steel to be used. Shells of more than 1.80 m in diameter shall be not less than 6 mm thick in the reference steel or of equivalent thickness in the steel to be used.

6.7.3.4.3 The cylindrical portions, ends (heads) and manhole covers of all shells shall be not less than 4 mm thick regardless of the material of construction.

6.7.3.4.4 The equivalent thickness of a steel other than the thickness prescribed for the reference steel in 6.7.3.4.2 shall be determined using the following formula:

$$e_1 = \frac{21.4 \times e_0}{\sqrt[3]{R_{m1} \times A_1}}$$

where:

- $e_1$  = required equivalent thickness (in mm) of the steel to be used;
- $e_0$  = minimum thickness (in mm) of the reference steel specified in 6.7.3.4.2;
- $R_{m1}$  = guaranteed minimum tensile strength (in N/mm<sup>2</sup>) of the steel to be used (see 6.7.3.3.3);
- $A_1$  = guaranteed minimum elongation at fracture (in %) of the steel to be used according to national or international standards.

6.7.3.4.5 In no case shall the wall thickness be less than that prescribed in 6.7.3.4.1 to 6.7.3.4.3. All parts of the shell shall have a minimum thickness as determined by 6.7.3.4.1 to 6.7.3.4.3. This thickness shall be exclusive of any corrosion allowance.

6.7.3.4.6 When mild steel is used (see 6.7.3.1), calculation using the equation in 6.7.3.4.4 is not required.

6.7.3.4.7 There shall be no sudden change of plate thickness at the attachment of the ends (heads) to the cylindrical portion of the shell.

**6.7.3.5 Service equipment**

6.7.3.5.1 Service equipment shall be so arranged as to be protected against the risk of being wrenched off or damaged during handling and transport. When the connection between the frame and the shell allows relative movement between the sub-assemblies, the equipment shall be so fastened as to permit such movement without risk of damage to working parts. The external discharge fittings (pipe sockets, shut-off devices), the internal stop-valve and its seating shall be protected against the danger of being wrenched off by external forces (for example, by using shear sections). The filling and discharge devices (including flanges or threaded plugs) and any protective caps shall be capable of being secured against unintended opening.

6.7.3.5.1.1 For offshore tank-containers, where positioning of service equipment and the design and strength of protection for such equipment is concerned, the increased danger of impact damage when handling such tanks in open seas shall be taken into account.

6.7.3.5.2 All openings with a diameter of more than 1.5 mm in shells of portable tanks, except openings for pressure relief devices, inspection openings and closed bleed holes, shall be fitted with at least three mutually independent shut-off devices in series, the first being an internal stop-valve, excess flow valve or equivalent device, the second being an external stop-valve and the third being a blank flange or equivalent device.

6.7.3.5.2.1 When a portable tank is fitted with an excess flow valve, the excess flow valve shall be so fitted that its seating is inside the shell or inside a welded flange or, when fitted externally, its mountings shall be designed so that, in the event of impact, its effectiveness shall be maintained. The excess flow valves shall be selected and fitted so as to close automatically when the rated flow specified by the manufacturer is reached. Connections and accessories leading to or from such a valve shall have a capacity for a flow more than the rated flow of the excess flow valve.

6.7.3.5.3 For filling and discharge openings, the first shut-off device shall be an internal stop-valve and the second shall be a stop-valve placed in an accessible position on each discharge and filling pipe.



## Chapter 6.7 – Design, construction, inspection and testing of portable tanks &amp; MEGCs

- 6.7.3.5.4 For filling and discharge bottom openings of portable tanks intended for the transport of flammable and/or toxic non-refrigerated liquefied gases or chemicals under pressure, the internal stop-valve shall be a quick-closing safety device which closes automatically in the event of unintended movement of the portable tank during filling or discharge or fire engulfment. Except for portable tanks having a capacity of not more than 1000 L, it shall be possible to operate this device by remote control.
- 6.7.3.5.5 In addition to filling, discharge and gas pressure equalizing orifices, shells may have openings in which gauges, thermometers and manometers can be fitted. Connections for such instruments shall be made by suitable welded nozzles or pockets and not be screwed connections through the shell.
- 6.7.3.5.6 All portable tanks shall be fitted with manholes or other inspection openings of suitable size to allow for internal inspection and adequate access for maintenance and repair of the interior.
- 6.7.3.5.7 External fittings shall be grouped together so far as reasonably practicable.
- 6.7.3.5.8 Each connection on a portable tank shall be clearly marked to indicate its function.
- 6.7.3.5.9 Each stop-valve or other means of closure shall be designed and constructed to a rated pressure not less than the MAWP of the shell, taking into account the temperatures expected during transport. All stop-valves with a screwed spindle shall close by a clockwise motion of the handwheel. For other stop-valves, the position (open and closed) and direction of closure shall be clearly indicated. All stop-valves shall be designed to prevent unintentional opening.
- 6.7.3.5.10 Piping shall be designed, constructed and installed so as to avoid the risk of damage due to thermal expansion and contraction, mechanical shock and vibration. All piping shall be of suitable metallic material. Welded pipe joints shall be used wherever possible.
- 6.7.3.5.11 Joints in copper tubing shall be brazed or have an equally strong metal union. The melting point of brazing materials shall be no lower than 525°C. The joints shall not decrease the strength of tubing, as may happen when cutting threads.
- 6.7.3.5.12 The burst pressure of all piping and pipe fittings shall be not less than the highest of four times the MAWP of the shell or four times the pressure to which it may be subjected in service by the action of a pump or other device (except pressure relief devices).
- 6.7.3.5.13 Ductile metals shall be used in the construction of valves and accessories.
- 6.7.3.6 Bottom openings**
- 6.7.3.6.1 Certain non-refrigerated liquefied gases shall not be transported in portable tanks with bottom openings when portable tank instruction T50 in 4.2.5.2.6 indicates that bottom openings are not allowed. There shall be no openings below the liquid level of the shell when it is filled to its maximum permissible filling limit.
- 6.7.3.7 Pressure relief devices**
- 6.7.3.7.1 Portable tanks shall be provided with one or more spring-loaded pressure relief devices. The pressure relief devices shall open automatically at a pressure not less than the MAWP and be fully open at a pressure equal to 110% of the MAWP. These devices shall, after discharge, close at a pressure not lower than 10% below the pressure at which discharge starts and shall remain closed at all lower pressures. The pressure relief devices shall be of a type that will resist dynamic forces, including liquid surge. Frangible discs not in series with a spring-loaded pressure relief device are not permitted.
- 6.7.3.7.2 Pressure relief devices shall be designed to prevent the entry of foreign matter, the leakage of gas and the development of any dangerous excess pressure.
- 6.7.3.7.3 Portable tanks intended for the transport of certain non-refrigerated liquefied gases identified in portable tank instruction T50 in 4.2.5.2.6 shall have a pressure relief device approved by the competent authority. Unless a portable tank in dedicated service is fitted with an approved relief device constructed of materials compatible with the load, such device shall comprise a frangible disc preceding a spring-loaded device. The space between the frangible disc and the device shall be provided with a pressure gauge or a suitable tell-tale indicator. This arrangement permits the detection of disc rupture, pinholing or leakage which could cause a malfunction of the pressure relief device. The frangible discs shall rupture at a nominal pressure 10% above the start-to-discharge pressure of the relief device.
- 6.7.3.7.4 In the case of multi-purpose portable tanks, the pressure relief devices shall open at a pressure indicated in 6.7.3.7.1 for the gas having the highest maximum allowable pressure of the gases allowed to be transported in the portable tank.

Part 6 – Construction and testing of packagings, IBCs, etc.

6.7.3.8 Capacity of relief devices

6.7.3.8.1 The combined delivery capacity of the relief devices shall be sufficient that, in the event of total fire engulfment, the pressure (including accumulation) inside the shell does not exceed 120% of the MAWP. Spring-loaded relief devices shall be used to achieve the full relief capacity prescribed. In the case of multi-purpose tanks, the combined delivery capacity of the pressure relief devices shall be taken for the gas which requires the highest delivery capacity of the gases allowed to be transported in portable tanks.

6.7.3.8.1.1 To determine the total required capacity of the relief devices, which shall be regarded as being the sum of the individual capacities of the several devices, the following formula shall be used:

$$Q = 12.4 \frac{FA^{0.82}}{LC} \sqrt{\frac{ZT}{M}}$$

where:

$Q$  = minimum required rate of discharge in cubic metres of air per second ( $m^3/s$ ) at standard conditions: 1 bar and 0°C (273 K);

$F$  = a coefficient with the following value:

for uninsulated shells,  $F = 1$

for insulated shells,  $F = U(649 - t)/13.6$  but in no case is less than 0.25

where:

$\Delta U$  = heat transfer coefficient of the insulation, in  $kW \cdot m^{-2} \cdot K^{-1}$ , at 38°C;

$t$  = actual temperature of the non-refrigerated liquefied gas during filling (in °C) (when this temperature is unknown, let  $t = 15^\circ C$ );

The value of  $F$  given above for insulated shells may be taken provided that the insulation is in conformance with 6.7.3.8.1.2;

$A$  = total external surface area of shell in square metres;

$Z$  = the gas compressibility factor in the accumulating condition (when this factor is unknown, let  $Z$  equal 1.0);

$T$  = absolute temperature in kelvin ( $^\circ C + 273$ ) above the pressure relief devices in the accumulating condition;

$L$  = the latent heat of vaporization of the liquid, in  $kJ/kg$ , in the accumulating condition;

$M$  = molecular mass of the discharged gas;

$C$  = a constant which is derived from one of the following formulae as a function of the ratio  $k$  of specific heats:

$$k = \frac{C_p}{C_v}$$

where:

$C_p$  = specific heat at constant pressure; and

$C_v$  = specific heat at constant volume.

When  $k > 1$ :

$$C = \sqrt{k \left( \frac{2}{k+1} \right)^{\frac{k+1}{k-1}}}$$

When  $k = 1$  or  $k$  is unknown:

$$C = \frac{1}{\sqrt{e}} = 0.607$$

where  $e$  is the mathematical constant 2.7183.

Chapter 6.7 – Design, construction, inspection and testing of portable tanks & MEGCs

C may also be taken from the following table:

| <i>k</i> | <i>C</i> | <i>k</i> | <i>C</i> | <i>k</i> | <i>C</i> |
|----------|----------|----------|----------|----------|----------|
| 1.00     | 0.607    | 1.26     | 0.660    | 1.52     | 0.704    |
| 1.02     | 0.611    | 1.28     | 0.664    | 1.54     | 0.707    |
| 1.04     | 0.615    | 1.30     | 0.667    | 1.56     | 0.71     |
| 1.06     | 0.620    | 1.32     | 0.671    | 1.58     | 0.713    |
| 1.08     | 0.624    | 1.34     | 0.674    | 1.60     | 0.716    |
| 1.10     | 0.628    | 1.36     | 0.678    | 1.62     | 0.719    |
| 1.12     | 0.633    | 1.38     | 0.681    | 1.64     | 0.722    |
| 1.14     | 0.637    | 1.40     | 0.685    | 1.66     | 0.725    |
| 1.16     | 0.641    | 1.42     | 0.688    | 1.68     | 0.728    |
| 1.18     | 0.645    | 1.44     | 0.691    | 1.70     | 0.731    |
| 1.20     | 0.649    | 1.46     | 0.695    | 2.0      | 0.77     |
| 1.22     | 0.652    | 1.48     | 0.698    | 2.2      | 0.793    |
| 1.24     | 0.656    | 1.50     | 0.701    |          |          |

**Note:** This formula applies only to non-refrigerated liquefied gases which have critical temperatures well above the temperature at the accumulating condition. For gases which have critical temperatures near or below the temperature at the accumulating condition, the calculation of the pressure-relief device delivery capacity shall consider further thermodynamic properties of the gas (see, e.g. CGA S-1.2-2003 Pressure Relief Device Standards – Part 2 – Cargo and Portable Tanks for Compressed Gases).

6.7.3.8.1.2 Insulation systems, used for the purpose of reducing the venting capacity, shall be approved by the competent authority or its authorized body. In all cases, insulation systems approved for this purpose shall:

- .1 remain effective at all temperatures up to 649°C; and
- .2 be jacketed with a material having a melting point of 700°C or greater.

6.7.3.9 **Marking of pressure relief devices**

6.7.3.9.1 Every pressure relief device shall be clearly and permanently marked with the following:

- .1 the pressure (in bar or kPa) at which it is set to discharge;
- .2 the allowable tolerance at the discharge pressure, for spring-loaded devices;
- .3 the reference temperature corresponding to the rated pressure, for frangible discs;
- .4 the rated flow capacity of the device in standard cubic metres of air per second (m<sup>3</sup>/s); and
- .5 the cross sectional flow areas of the spring-loaded pressure relief devices and frangible discs in mm<sup>2</sup>.

When practicable, the following information shall also be shown:

- .6 the manufacturer's name and relevant catalogue number.

6.7.3.9.2 The rated flow capacity marked on the pressure relief devices shall be determined according to ISO 4126-1:2004 and ISO 4126-7:2004.

6.7.3.10 **Connections to pressure relief devices**

6.7.3.10.1 Connections to pressure relief devices shall be of sufficient size to enable the required discharge to pass unrestricted to the safety device. No stop-valve shall be installed between the shell and the pressure relief devices except when duplicate devices are provided for maintenance or other reasons and the stop-valves serving the devices actually in use are locked open or the stop-valves are interlocked so that at least one of the duplicate devices is always operable and capable of meeting the provisions of 6.7.3.8. There shall be no obstruction in an opening leading to a vent or pressure relief device which might restrict or cut off the flow from the shell to that device. Vents from the pressure relief devices, when used, shall deliver the relieved vapour or liquid to the atmosphere in conditions of minimum back-pressure on the relieving device.

6.7.3.11 **Siting of pressure relief devices**

6.7.3.11.1 Each pressure relief device inlet shall be situated on top of the shell in a position as near the longitudinal and transverse centre of the shell as reasonably practicable. All pressure relief device inlets shall, under maximum filling conditions, be situated in the vapour space of the shell and the devices shall be so arranged as to ensure that the escaping vapour is discharged unrestrictedly. For flammable non-refrigerated liquefied gases, the escaping vapour shall be directed away from the shell in such a manner that it cannot impinge upon the shell. Protective devices which deflect the flow of vapour are permissible provided the required relief-device capacity is not reduced.



**Part 6 – Construction and testing of packagings, IBCs, etc.**

- 6.7.3.11.2 Arrangements shall be made to prevent access to the pressure relief devices by unauthorized persons and to protect the devices from damage caused by the portable tank overturning.
- 6.7.3.12 **Gauging devices**
- 6.7.3.12.1 Unless a portable tank is intended to be filled by mass, it shall be equipped with one or more gauging devices. Glass level-gauges and gauges made of other fragile material, which are in direct communication with the contents of the shell, shall not be used.
- 6.7.3.13 **Portable tank supports, frameworks, lifting and tie-down attachments**
- 6.7.3.13.1 Portable tanks shall be designed and constructed with a support structure to provide a secure base during transport. The forces specified in 6.7.3.2.9 and the safety factor specified in 6.7.3.2.10 shall be considered in this aspect of the design. Skids, frameworks, cradles or other similar structures are acceptable.
- 6.7.3.13.2 The combined stresses caused by portable tank mountings (such as cradles, frameworks, etc.) and portable tank lifting and tie-down attachments shall not cause excessive stress in any portion of the shell. Permanent lifting and tie-down attachments shall be fitted to all portable tanks. Preferably they shall be fitted to the portable tank supports but may be secured to reinforcing plates located on the shell at the points of support.
- 6.7.3.13.3 In the design of supports and frameworks, the effects of environmental corrosion shall be taken into account.
- 6.7.3.13.4 Forklift pockets shall be capable of being closed off. The means of closing forklift pockets shall be a permanent part of the framework or permanently attached to the framework. Single-compartment portable tanks with a length less than 3.65 m need not have closed-off forklift pockets provided that:
- .1 the shell and all the fittings are well protected from being hit by the forklift blades; and
  - .2 the distance between the centres of the forklift pockets is at least half of the maximum length of the portable tank.
- 6.7.3.13.5 When portable tanks are not protected during transport, according to 4.2.2.3, the shells and service equipment shall be protected against damage to the shell and service equipment resulting from lateral or longitudinal impact or overturning. External fittings shall be protected so as to preclude the release of the shell contents upon impact or overturning of the portable tank on its fittings. Examples of protection include:
- .1 protection against lateral impact, which may consist of longitudinal bars protecting the shell on both sides at the level of the median line;
  - .2 protection of the portable tank against overturning, which may consist of reinforcement rings or bars fixed across the frame;
  - .3 protection against rear impact, which may consist of a bumper or frame;
  - .4 protection of the shell against damage from impact or overturning by use of an ISO frame in accordance with ISO 1496-3:1995.
- 6.7.3.14 **Design approval**
- 6.7.3.14.1 The competent authority or its authorized body shall issue a design approval certificate for any new design of a portable tank. This certificate shall attest that the portable tank has been surveyed by that authority, is suitable for its intended purpose and meets the provisions of this chapter and, when appropriate, the provisions for gases provided in portable tank instruction T50 in 4.2.5.2.6. When a series of portable tanks are manufactured without change in the design, the certificate shall be valid for the entire series. The certificate shall refer to the prototype test report, the gases allowed to be transported, the materials of construction of the shell and an approval number. The approval number shall consist of the distinguishing sign or mark of the State in whose territory the approval was granted, indicated by the distinguishing sign used on vehicles in international road traffic\* and a registration number. Any alternative arrangements according to 6.7.1.2 shall be indicated on the certificate. A design approval may serve for the approval of smaller portable tanks made of materials of the same kind and thickness, by the same fabrication techniques and with identical supports, equivalent closures and other appurtenances.
- 6.7.3.14.2 The prototype test report for the design approval shall include at least the following:
- .1 the results of the applicable framework test specified in ISO 1496-3:1995;
  - .2 the results of the initial inspection and test in 6.7.3.15.3; and
  - .3 the results of the impact test in 6.7.3.15.1, when applicable.
- 6.7.3.15 **Inspection and testing**
- 6.7.3.15.1 Portable tanks meeting the definition of *container* in the *International Convention for Safe Containers, 1972* (CSC Convention), as amended, shall not be used unless they are successfully qualified by subjecting a

\* Distinguishing sign of the State of registration used on motor vehicles and trailers in international road traffic, e.g. in accordance with the Geneva Convention on Road Traffic of 1949 or the Vienna Convention on Road Traffic of 1968.

## Chapter 6.7 – Design, construction, inspection and testing of portable tanks &amp; MEGCs

representative prototype of each design to the Dynamic, Longitudinal Impact Test prescribed in the *Manual of Tests and Criteria*, part IV, section 41. This provision only applies to portable tanks which are constructed according to a design approval certificate which has been issued on or after 1 January 2008.

- 6.7.3.15.2 The shell and items of equipment of each portable tank shall be inspected and tested before being put into service for the first time (initial inspection and test) and thereafter at not more than five-year intervals (5-year periodic inspection and test) with an intermediate periodic inspection and test (2.5-year periodic inspection and test) midway between the 5-year periodic inspections and tests. The 2.5-year periodic inspection and test may be performed within 3 months of the specified date. An exceptional inspection and test shall be performed regardless of the last periodic inspection and test when necessary according to 6.7.3.15.7.
- 6.7.3.15.3 The initial inspection and test of a portable tank shall include a check of the design characteristics, an internal and external examination of the portable tank and its fittings with due regard to the non-refrigerated liquefied gases to be transported, and a pressure test referring to the test pressures according to 6.7.3.3.2. The pressure test may be performed as a hydraulic test or by using another liquid or gas with the agreement of the competent authority or its authorized body. Before the portable tank is placed into service, a leakproofness test and a test of the satisfactory operation of all service equipment shall also be performed. When the shell and its fittings have been pressure-tested separately, they shall be subjected together after assembly to a leakproofness test. All welds subject to full stress level in the shell shall be inspected during the initial test by radiographic, ultrasonic, or another suitable non-destructive test method. This does not apply to the jacket.
- 6.7.3.15.4 The 5-year periodic inspection and test shall include an internal and external examination and, as a general rule, a hydraulic pressure test. Sheathing, thermal insulation and the like shall be removed only to the extent required for reliable appraisal of the condition of the portable tank. When the shell and equipment have been pressure-tested separately, they shall be subjected together after assembly to a leakproofness test.
- 6.7.3.15.5 The intermediate 2.5-year periodic inspection and test shall at least include an internal and external examination of the portable tank and its fittings with due regard to the non-refrigerated liquefied gases intended to be transported, a leakproofness test and a test of the satisfactory operation of all service equipment. Sheathing, thermal insulation and the like shall be removed only to the extent required for reliable appraisal of the condition of the portable tank. For portable tanks intended for the transport of a single non-refrigerated liquefied gas, the 2.5-year internal examination may be waived or substituted by other test methods or inspection procedures specified by the competent authority or its authorized body.
- 6.7.3.15.6 A portable tank may not be filled and offered for transport after the date of expiry of the last 5-year or 2.5-year periodic inspection and test as required by 6.7.3.15.2. However, a portable tank filled prior to the date of expiry of the last periodic inspection and test may be transported for a period not to exceed three months beyond the date of expiry of the last periodic test or inspection. In addition, a portable tank may be transported after the date of expiry of the last periodic test and inspection:
- .1 after emptying but before cleaning, for purposes of performing the next required test or inspection prior to refilling; and
  - .2 unless otherwise approved by the competent authority, for a period not to exceed six months beyond the date of expiry of the last periodic test or inspection, in order to allow the return of dangerous goods for proper disposal or recycling. Reference to this exemption shall be mentioned in the transport document.
- Except as provided for in this paragraph, portable tanks which have missed the timeframe for their scheduled 5-year or 2.5-year periodic inspection and test may only be filled and offered for transport if a new 5-year periodic inspection and test is performed according to 6.7.3.15.4.
- 6.7.3.15.7 The exceptional inspection and test is necessary when the portable tank shows evidence of damaged or corroded areas, or leakage, or other conditions that indicate a deficiency that could affect the integrity of the portable tank. The extent of the exceptional inspection and test shall depend on the amount of damage or deterioration of the portable tank. It shall include at least the 2.5-year inspection and test according to 6.7.3.15.5.
- 6.7.3.15.8 The internal and external examinations shall ensure that:
- .1 the shell is inspected for pitting, corrosion, or abrasions, dents, distortions, defects in welds or any other conditions, including leakage, that might render the portable tank unsafe for transport. The wall thickness shall be verified by appropriate measurement if this inspection indicates a reduction of wall thickness;
  - .2 the piping, valves, and gaskets are inspected for corroded areas, defects, or any other conditions, including leakage, that might render the portable tank unsafe for filling, discharge or transport;
  - .3 devices for tightening manhole covers are operative and there is no leakage at manhole covers or gaskets;
  - .4 missing or loose bolts or nuts on any flanged connection or blank flange are replaced or tightened;
  - .5 all emergency devices and valves are free from corrosion, distortion and any damage or defect that could prevent their normal operation. Remote closure devices and self-closing stop-valves shall be operated to demonstrate proper operation;

**Part 6 – Construction and testing of packagings, IBCs, etc.**

- .6 required marks on the portable tank are legible and in accordance with the applicable provisions; and
- .7 the framework, the supports and the arrangements for lifting the portable tank are in satisfactory condition.

**6.7.3.15.9** The inspections and tests in 6.7.3.15.1, 6.7.3.15.3, 6.7.3.15.4, 6.7.3.15.5 and 6.7.3.15.7 shall be performed or witnessed by an expert approved by the competent authority or its authorized body. When the pressure test is a part of the inspection and test, the test pressure shall be the one indicated on the data plate of the portable tank. While under pressure, the portable tank shall be inspected for any leaks in the shell, piping or equipment.

**6.7.3.15.10** In all cases when cutting, burning or welding operations on the shell have been effected, that work shall be to the approval of the competent authority or its authorized body, taking into account the pressure-vessel code used for the construction of the shell. A pressure test to the original test pressure shall be performed after the work is completed.

**6.7.3.15.11** When evidence of any unsafe condition is discovered, the portable tank shall not be returned to service until it has been corrected and the pressure test is repeated and passed.

**6.7.3.16 Marking**

**6.7.3.16.1** Every portable tank shall be fitted with a corrosion-resistant metal plate permanently attached to the portable tank in a conspicuous place readily accessible for inspection. When for reasons of portable tank arrangements the plate cannot be permanently attached to the shell, the shell shall be marked with at least the information required by the pressure-vessel code. As a minimum, at least the following information shall be marked on the plate by stamping or by any other similar method:

- (a) owner information
  - (i) owner's registration number;
- (b) manufacturing information
  - (i) country of manufacture;
  - (ii) year of manufacture;
  - (iii) manufacturer's name or mark;
  - (iv) manufacturer's serial number;
- (c) approval information
  - (i) the United Nations packaging symbol:



This symbol shall not be used for any purpose other than certifying that a packaging, a flexible bulk container, a portable tank or a MEGC complies with the relevant requirements in chapters 6.1, 6.2, 6.3, 6.5, 6.6, 6.7 or 6.9;

- (ii) approval country;
- (iii) authorized body for the design approval;
- (iv) design approval number;
- (v) letters "AA", if the design was approved under alternative arrangements (see 6.7.1.2);
- (vi) pressure-vessel code to which the shell is designed;
- (d) pressures
  - (i) MAWP (in bar gauge or kPa gauge);\*
  - (ii) test pressure (in bar gauge or kPa gauge);\*
  - (iii) initial pressure test date (month and year);
  - (iv) identification mark of the initial pressure test witness;
  - (v) external design pressure<sup>†</sup> (in bar gauge or kPa gauge);\*
- (e) temperatures
  - (i) design temperature range (in °C);\*
  - (ii) design reference temperature (in °C);\*
- (f) materials
  - (i) shell material(s) and material standard reference(s);
  - (ii) equivalent thickness in reference steel (in mm);\*

\* The unit used shall be indicated.

<sup>†</sup> See 6.7.3.2.8.



Chapter 6.7 – Design, construction, inspection and testing of portable tanks & MEGCs

- (g) capacity
  - (i) tank water capacity at 20°C (in litres);\*
- (h) periodic inspections and tests
  - (i) type of the most recent periodic test (2.5-year, 5-year or exceptional);
  - (ii) date of the most recent periodic test (month and year);
  - (iii) test pressure (in bar gauge or kPa gauge)\* of the most recent periodic test (if applicable);
  - (iv) identification mark of the authorized body who performed or witnessed the most recent test.

Figure 6.7.3.16.1 – Example of a plate for marking

| Owner's registration number  |                                     |  |            |                |           |  |            |
|--|-------------------------------------|--|------------|----------------|-----------|--|------------|
| <b>MANUFACTURING INFORMATION</b>   |                                     |  |            |                |           |  |            |
| Country of manufacture   |                                     |  |            |                |           |  |            |
| Year of manufacture  |                                     |  |            |                |           |  |            |
| Manufacturer   |                                     |  |            |                |           |  |            |
| Manufacturer's serial number   |                                     |  |            |                |           |  |            |
| <b>APPROVAL INFORMATION</b>  |                                     |  |            |                |           |  |            |
|  | Approval country                    |  |            |                |           |  |            |
|  | Authorized body for design approval |  |            |                |           |  |            |
|  | Design approval number              |  |            |                |           | "AA" (if applicable)                         |            |
| Shell design code (pressure-vessel code)   |                                     |  |            |                |           |  |            |
| <b>PRESSURES</b>   |                                     |  |            |                |           |  |            |
| MAWP   |                                     | bar or kPa                                   |            |                |           |  |            |
| Test pressure  |                                     | bar or kPa                                   |            |                |           |  |            |
| Initial pressure test date:  |                                     | (mm/yyyy)                                    |            | Witness stamp: |           |  |            |
| External design pressure   |                                     | bar or kPa                                   |            |                |           |  |            |
| <b>TEMPERATURES</b>  |                                     |  |            |                |           |  |            |
| Design temperature range   |                                     | °C to °C                                     |            |                |           |  |            |
| Design reference temperature   |                                     | °C   |            |                |           |  |            |
| <b>MATERIALS</b>   |                                     |  |            |                |           |  |            |
| Shell material(s) and material standard reference(s)                               |                                     |  |            |                |           |  |            |
| Equivalent thickness in reference steel  |                                     | mm   |            |                |           |  |            |
| <b>CAPACITY</b>  |                                     |  |            |                |           |  |            |
| Tank water capacity at 20°C  |                                     | litres                                       |            |                |           |  |            |
| <b>PERIODIC INSPECTIONS/TESTS</b>  |                                     |  |            |                |           |  |            |
| Test type  | Test date                           | Witness stamp and test pressure <sup>a</sup> |            | Test type      | Test date | Witness stamp and test pressure <sup>a</sup> |            |
|  | (mm/yyyy)                           |  | bar or kPa |                | (mm/yyyy) |  | bar or kPa |
|  |                                     |  |            |                |           |  |            |
|  |                                     |  |            |                |           |  |            |
|  |                                     |  |            |                |           |  |            |

<sup>a</sup> Test pressure if applicable.



**Part 6 – Construction and testing of packagings, IBCs, etc.**

- 6.7.3.16.2 The following information shall be durably marked either on the portable tank itself or on a metal plate firmly secured to the portable tank:
- Name of the operator
  - Name of non-refrigerated liquefied gas(es) permitted for transport
  - Maximum permissible load mass for each non-refrigerated liquefied gas permitted . . . . . kg
  - Maximum permissible gross mass (MPGM) . . . . . kg
  - Unladen (tare) mass . . . . . kg
  - Portable tank instruction in accordance with 4.2.5.2.6.

- 6.7.3.16.3 If a portable tank is designed and approved for handling in open seas, the words “OFFSHORE PORTABLE TANK” shall be marked on the identification plate.

## 6.7.4 Provisions for the design, construction, inspection and testing of portable tanks intended for the transport of refrigerated liquefied gases of class 2

### 6.7.4.1 Definitions

For the purposes of this section:

*Holding time* means the time that will elapse from the establishment of the initial filling condition until the pressure has risen due to heat influx to the lowest set pressure of the pressure-limiting device(s);

*Jacket* means the outer insulation cover or cladding, which may be part of the insulation system;

*Leakproofness test* means a test, using gas, subjecting the shell and its service equipment to an effective internal pressure not less than 90% of the MAWP;

*Maximum allowable working pressure (MAWP)* means the maximum effective gauge pressure permissible at the top of the shell of a filled portable tank in its operating position, including the highest effective pressure during filling and discharge;

*Maximum permissible gross mass (MPGM)* means the sum of the tare mass of the portable tank and the heaviest load authorized for transport;

*Minimum design temperature* means the temperature which is used for the design and construction of the shell, not higher than the lowest (coldest) temperature (service temperature) of the contents during normal conditions of filling, discharge and transport;

*Portable tank* means a thermally insulated multimodal tank having a capacity of more than 450 L fitted with service equipment and structural equipment necessary for the transport of refrigerated liquefied gases. The portable tank shall be capable of being filled and discharged without the removal of its structural equipment. It shall possess stabilizing members external to the tank, and shall be capable of being lifted when full. It shall be designed primarily to be loaded onto a transport vehicle or ship and shall be equipped with skids, mountings or accessories to facilitate mechanical handling. Road tank-vehicles, rail tank-wagons, non-metallic tanks, intermediate bulk containers (IBCs), gas cylinders and large receptacles are not considered to fall within the definition for portable tanks;

*Reference steel* means a steel with a tensile strength of 370 N/mm<sup>2</sup> and an elongation at fracture of 27%;

*Service equipment* means measuring instruments and filling, discharge, venting, safety, pressurizing, cooling and thermal insulation devices;

*Shell* means the part of the portable tank which retains the refrigerated liquefied gas intended for transport, including openings and their closures, but does not include service equipment or external structural equipment;

*Structural equipment* means the reinforcing, fastening, protective and stabilizing members external to the shell;

*Tank* means a construction which normally consists of either:

- (a) a jacket and one or more inner shells where the space between the shell(s) and the jacket is exhausted of air (vacuum insulation) and may incorporate a thermal insulation system; or
- (b) a jacket and an inner shell with an intermediate layer of solid thermally insulating material (such as solid foam);

*Test pressure* means the maximum gauge pressure at the top of the shell during the pressure test.

### 6.7.4.2 General design and construction provisions

- 6.7.4.2.1 Shells shall be designed and constructed in accordance with the provisions of a pressure-vessel code recognized by the competent authority. Shells and jackets shall be made of metallic materials suitable for forming. Jackets shall be made of steel. Non-metallic materials may be used for the attachments and supports between the shell and jacket, provided their material properties at the minimum design temperature are proven to be sufficient. The materials shall, in principle, conform to national or international material

## Chapter 6.7 – Design, construction, inspection and testing of portable tanks &amp; MEGCs

standards. For welded shells and jackets, only materials whose weldability has been fully demonstrated shall be used. Welds shall be skilfully made and afford complete safety. When the manufacturing process or the materials make it necessary, the shell shall be suitably heat-treated to guarantee adequate toughness in the weld and in the heat-affected zones. In choosing the material, the minimum design temperature shall be taken into account with respect to risk of brittle fracture, to hydrogen embrittlement, to stress corrosion cracking and to resistance to impact. When fine-grain steel is used, the guaranteed value of the yield strength shall be not more than 460 N/mm<sup>2</sup> and the guaranteed value of the upper limit of the tensile strength shall be not more than 725 N/mm<sup>2</sup>, in accordance with the material specifications. Portable tank materials shall be suitable for the external environment in which they may be transported.

- 6.7.4.2.2 Any part of a portable tank, including fittings, gaskets and pipe-work, which can be expected normally to come into contact with the refrigerated liquefied gas transported shall be compatible with that refrigerated liquefied gas.
- 6.7.4.2.3 Contact between dissimilar metals which could result in damage by galvanic action shall be avoided.
- 6.7.4.2.4 The thermal insulation system shall include a complete covering of the shell(s) with effective insulating materials. External insulation shall be protected by a jacket so as to prevent the ingress of moisture and other damage under normal transport conditions.
- 6.7.4.2.5 When a jacket is so closed as to be gas-tight, a device shall be provided to prevent any dangerous pressure from developing in the insulation space.
- 6.7.4.2.6 Portable tanks intended for the transport of refrigerated liquefied gases having a boiling point below –182°C at atmospheric pressure shall not include materials which may react with oxygen or oxygen-enriched atmospheres in a dangerous manner when located in parts of the thermal insulation when there is a risk of contact with oxygen or with oxygen-enriched fluid.
- 6.7.4.2.7 Insulating materials shall not deteriorate unduly in service.
- 6.7.4.2.8 A reference holding time shall be determined for each refrigerated liquefied gas intended for transport in a portable tank.
- 6.7.4.2.8.1 The reference holding time shall be determined by a method recognized by the competent authority on the basis of the following:
- .1 the effectiveness of the insulation system, determined in accordance with 6.7.4.2.8.2;
  - .2 the lowest set pressure of the pressure-limiting device(s);
  - .3 the initial filling conditions;
  - .4 an assumed ambient temperature of 30°C;
  - .5 the physical properties of the individual refrigerated liquefied gas intended to be transported.
- 6.7.4.2.8.2 The effectiveness of the insulation system (heat influx in watts) shall be determined by type testing the portable tank in accordance with a procedure recognized by the competent authority. This test shall consist of either:
- .1 a constant-pressure test (for example at atmospheric pressure), when the loss of refrigerated liquefied gas is measured over a period of time; or
  - .2 a closed-system test, when the rise in pressure in the shell is measured over a period of time.
- When performing the constant-pressure test, variations in atmospheric pressure shall be taken into account. When performing either test, corrections shall be made for any variation of the ambient temperature from the assumed ambient temperature reference value of 30°C.
- Note:** For the determination of the actual holding time before each journey, see 4.2.3.7.
- 6.7.4.2.9 The jacket of a vacuum-insulated double-wall tank shall have either an external design pressure not less than 100 kPa (1 bar) gauge pressure calculated in accordance with a recognized technical code or a calculated critical collapsing pressure of not less than 200 kPa (2 bar) gauge pressure. Internal and external reinforcements may be included in calculating the ability of the jacket to resist the external pressure.
- 6.7.4.2.10 Portable tanks shall be designed and constructed with supports to provide a secure base during transport and with suitable lifting and tie-down attachments.
- 6.7.4.2.11 Portable tanks shall be designed to withstand, without loss of contents, at least the internal pressure due to the contents and the static, dynamic and thermal loads during normal conditions of handling and transport. The design shall demonstrate that the effects of fatigue, caused by repeated application of these loads through the expected life of the portable tank, have been taken into account.
- 6.7.4.2.11.1 For tanks that are intended for use as offshore tank-containers, the dynamic stresses imposed by handling in open seas shall be taken into account.

**Part 6 – Construction and testing of packagings, IBCs, etc.**

- 6.7.4.2.12 Portable tanks and their fastenings under the maximum permissible load shall be capable of absorbing the following separately applied static forces:
- .1 in the direction of travel: twice the MPGM multiplied by the acceleration due to gravity (g);\*
  - .2 horizontally at right angles to the direction of travel: the MPGM (when the direction of travel is not clearly determined, the forces shall be equal to twice the MPGM) multiplied by the acceleration due to gravity (g);\*
  - .3 vertically upwards: the MPGM multiplied by the acceleration due to gravity (g);\* and
  - .4 vertically downwards: twice the MPGM (total loading including the effect of gravity) multiplied by the acceleration due to gravity (g).\*
- 6.7.4.2.13 Under each of the forces in 6.7.4.2.12, the safety factor to be observed shall be as follows:
- .1 for materials having a clearly defined yield point, a safety factor of 1.5 in relation to the guaranteed yield strength; or
  - .2 for materials with no clearly defined yield point, a safety factor of 1.5 in relation to the guaranteed 0.2% proof strength or, for austenitic steels, the 1% proof strength.
- 6.7.4.2.14 The values of yield strength or proof strength shall be the values according to national or international material standards. When austenitic steels are used, the specified minimum values according to the material standards may be increased by up to 15% when these greater values are attested in the material inspection certificate. When no material standard exists for the metal in question, or when non-metallic materials are used, the values of yield strength or proof strength shall be approved by the competent authority.
- 6.7.4.2.15 Portable tanks intended for the transport of flammable refrigerated liquefied gases shall be capable of being electrically earthed.
- 6.7.4.3 Design criteria**
- 6.7.4.3.1 Shells shall be of a circular cross-section.
- 6.7.4.3.2 Shells shall be designed and constructed to withstand a test pressure not less than 1.3 times the MAWP. For shells with vacuum insulation, the test pressure shall not be less than 1.3 times the sum of the MAWP and 100 kPa (1 bar). In no case shall the test pressure be less than 300 kPa (3 bar) gauge pressure. Attention is drawn to the minimum shell thickness provisions, specified in 6.7.4.4.2 to 6.7.4.4.7.
- 6.7.4.3.3 For metals exhibiting a clearly defined yield point or characterized by a guaranteed proof strength (0.2% proof strength, generally, or 1% proof strength for austenitic steels), the primary membrane stress  $\sigma$  (sigma) in the shell shall not exceed  $0.75R_e$  or  $0.50R_m$ , whichever is lower, at the test pressure, where:
- $R_e$  = yield strength in N/mm<sup>2</sup>, or 0.2% proof strength or, for austenitic steels, 1% proof strength;
- $R_m$  = minimum tensile strength in N/mm<sup>2</sup>.
- 6.7.4.3.3.1 The values of  $R_e$  and  $R_m$  to be used shall be the specified minimum values according to national or international material standards. When austenitic steels are used, the specified minimum values for  $R_e$  and  $R_m$  according to the material standards may be increased by up to 15% when greater values are attested in the material inspection certificate. When no material standard exists for the metal in question, the values of  $R_e$  and  $R_m$  used shall be approved by the competent authority or its authorized body.
- 6.7.4.3.3.2 Steels which have a  $R_e/R_m$  ratio of more than 0.85 are not allowed for the construction of welded shells. The values of  $R_e$  and  $R_m$  to be used in determining this ratio shall be the values specified in the material inspection certificate.
- 6.7.4.3.3.3 Steels used in the construction of shells shall have an elongation at fracture, in %, of not less than  $10,000/R_m$  with an absolute minimum of 16% for fine-grain steels and 20% for other steels. Aluminium and aluminium alloys used in the construction of shells shall have an elongation at fracture, in %, of not less than  $10,000/6R_m$  with an absolute minimum of 12%.
- 6.7.4.3.3.4 For the purpose of determining actual values for materials, it shall be noted that for sheet metal, the axis of the tensile test specimen shall be at right angles (transversely) to the direction of rolling. The permanent elongation at fracture shall be measured on test specimens of rectangular cross-section in accordance with ISO 6892:1998 using a 50 mm gauge length.
- 6.7.4.4 Minimum shell thickness**
- 6.7.4.4.1 The minimum shell thickness shall be the greater thickness based on:
- .1 the minimum thickness determined in accordance with the provisions in 6.7.4.4.2 to 6.7.4.4.7; and

\* For calculation purposes,  $g = 9.81 \text{ m/s}^2$ .

## Chapter 6.7 – Design, construction, inspection and testing of portable tanks &amp; MEGCs

.2 the minimum thickness determined in accordance with the recognized pressure-vessel code, including the provisions in 6.7.4.3.

6.7.4.4.2 Shells of not more than 1.80 m in diameter shall be not less than 5 mm thick in the reference steel or of equivalent thickness in the metal to be used. Shells of more than 1.80 m in diameter shall be not less than 6 mm thick in the reference steel or of equivalent thickness in the metal to be used.

6.7.4.4.3 Shells of vacuum-insulated tanks of not more than 1.80 m in diameter shall be not less than 3 mm thick in the reference steel or of equivalent thickness in the metal to be used. Such shells of more than 1.80 m in diameter shall be not less than 4 mm thick in the reference steel or of equivalent thickness in the metal to be used.

6.7.4.4.4 For vacuum-insulated tanks, the aggregate thickness of the jacket and the shell shall correspond to the minimum thickness prescribed in 6.7.4.4.2, the thickness of the shell itself being not less than the minimum thickness prescribed in 6.7.4.4.3.

6.7.4.4.5 Shells shall be not less than 3 mm thick regardless of the material of construction.

6.7.4.4.6 The equivalent thickness of a metal other than the thickness prescribed for the reference steel in 6.7.4.4.2 and 6.7.4.4.3 shall be determined using the following equation:

$$e_1 = \frac{21.4 \times e_0}{\sqrt[3]{R_{m1} \times A_1}}$$

where:

$e_1$  = required equivalent thickness (in mm) of the steel to be used;

$e_0$  = minimum thickness (in mm) of the reference steel specified in 6.7.4.4.2 and 6.7.4.4.3;

$R_{m1}$  = guaranteed minimum tensile strength (in N/mm<sup>2</sup>) of the metal to be used (see 6.7.4.3.3);

$A_1$  = guaranteed minimum elongation at fracture (in %) of the metal to be used according to national or international standards.

6.7.4.4.7 In no case shall the wall thickness be less than that prescribed in 6.7.4.4.1 to 6.7.4.4.5. All parts of the shell shall have a minimum thickness as determined by 6.7.4.4.1 to 6.7.4.4.6. This thickness shall be exclusive of any corrosion allowance.

6.7.4.4.8 There shall be no sudden change of plate thickness at the attachment of the ends (heads) to the cylindrical portion of the shell.

#### 6.7.4.5 Service equipment

6.7.4.5.1 Service equipment shall be so arranged as to be protected against the risk of being wrenched off or damaged during handling and transport. When the connection between the frame and the tank or the jacket and the shell allows relative movement, the equipment shall be so fastened as to permit such movement without risk of damage to working parts. The external discharge fittings (pipe sockets, shut-off devices), the stop-valve and its seating shall be protected against the danger of being wrenched off by external forces (for example, by using shear sections). The filling and discharge devices (including flanges or threaded plugs) and any protective caps shall be capable of being secured against unintended opening.

6.7.4.5.1.1 For offshore tank-containers, where positioning of service equipment and the design and strength of protection for such equipment is concerned, the increased danger of impact damage when handling such tanks in open seas shall be taken into account.

6.7.4.5.2 Each filling and discharge opening in portable tanks used for the transport of flammable refrigerated liquefied gases shall be fitted with at least three mutually independent shut-off devices in series, the first being a stop-valve situated as close as reasonably practicable to the jacket, the second being a stop-valve and the third being a blank flange or equivalent device. The shut-off device closest to the jacket shall be a quick-closing device, which closes automatically in the event of unintended movement of the portable tank during filling or discharge or fire engulfment. This device shall also be possible to operate by remote control.

6.7.4.5.3 Each filling and discharge opening in portable tanks used for the transport of non-flammable refrigerated liquefied gases shall be fitted with at least two mutually independent shut-off devices in series, the first being a stop-valve situated as close as reasonably practicable to the jacket, the second a blank flange or equivalent device.

6.7.4.5.4 For sections of piping which can be closed at both ends and where liquid product can be trapped, a method of automatic pressure relief shall be provided to prevent excess pressure build-up within the piping.

6.7.4.5.5 Vacuum-insulated tanks need not have an opening for inspection.

6.7.4.5.6 External fittings shall be grouped together so far as reasonably practicable.

6.7.4.5.7 Each connection on a portable tank shall be clearly marked to indicate its function.

**Part 6 – Construction and testing of packagings, IBCs, etc.**

- 6.7.4.5.8 Each stop-valve or other means of closure shall be designed and constructed to a rated pressure not less than the MAWP of the shell, taking into account the temperature expected during transport. All stop-valves with a screwed spindle shall be closed by a clockwise motion of the handwheel. In the case of other stop-valves, the position (open and closed) and direction of closure shall be clearly indicated. All stop-valves shall be designed to prevent unintentional opening.
- 6.7.4.5.9 When pressure-building units are used, the liquid and vapour connections to that unit shall be provided with a valve as close to the jacket as reasonably practicable to prevent the loss of contents in case of damage to the pressure-building unit.
- 6.7.4.5.10 Piping shall be designed, constructed and installed so as to avoid the risk of damage due to thermal expansion and contraction, mechanical shock and vibration. All piping shall be of a suitable material. To prevent leakage due to fire, only steel piping and welded joints shall be used between the jacket and the connection to the first closure of any outlet. The method of attaching the closure to this connection shall be to the satisfaction of the competent authority or its authorized body. Elsewhere, pipe joints shall be welded when necessary.
- 6.7.4.5.11 Joints in copper tubing shall be brazed or have an equally strong metal union. The melting point of brazing materials shall be no lower than 525°C. The joints shall not decrease the strength of the tubing, as may happen by cutting of threads.
- 6.7.4.5.12 The materials of construction of valves and accessories shall have satisfactory properties at the lowest operating temperature of the portable tank.
- 6.7.4.5.13 The burst pressure of all piping and pipe fittings shall be not less than the highest of four times the MAWP of the shell or four times the pressure to which it may be subjected in service by the action of a pump or other device (except pressure relief devices).
- 6.7.4.6 Pressure relief devices**
- 6.7.4.6.1 Every shell shall be provided with not less than two independent spring-loaded pressure relief devices. The pressure relief devices shall open automatically at a pressure not less than the MAWP and be fully open at a pressure equal to 110% of the MAWP. These devices shall, after discharge, close at a pressure not lower than 10% below the pressure at which discharge starts and shall remain closed at all lower pressures. The pressure relief devices shall be of the type that will resist dynamic forces, including surge.
- 6.7.4.6.2 Shells for non-flammable refrigerated liquefied gases and hydrogen may in addition have frangible discs in parallel with the spring-loaded devices as specified in 6.7.4.7.2 and 6.7.4.7.3.
- 6.7.4.6.3 Pressure relief devices shall be designed to prevent the entry of foreign matter, the leakage of gas and the development of any dangerous excess pressure.
- 6.7.4.6.4 Pressure relief devices shall be approved by the competent authority or its authorized body.
- 6.7.4.7 Capacity and setting of pressure relief devices**
- 6.7.4.7.1 In the case of the loss of vacuum in a vacuum-insulated tank or of loss of 20% of the insulation of a tank insulated with solid materials, the combined capacity of all pressure relief devices installed shall be sufficient so that the pressure (including accumulation) inside the shell does not exceed 120% of the MAWP.
- 6.7.4.7.2 For non-flammable refrigerated liquefied gases (except oxygen) and hydrogen, this capacity may be achieved by the use of frangible discs in parallel with the required safety relief devices. Frangible discs shall rupture at nominal pressure equal to the test pressure of the shell.
- 6.7.4.7.3 Under the circumstances described in 6.7.4.7.1 and 6.7.4.7.2 together with complete fire engulfment, the combined capacity of all pressure relief devices installed shall be sufficient to limit the pressure in the shell to the test pressure.
- 6.7.4.7.4 The required capacity of the relief devices shall be calculated in accordance with a well-established technical code recognized by the competent authority.\*
- 6.7.4.8 Marking of pressure relief devices**
- 6.7.4.8.1 Every pressure relief device shall be plainly and permanently marked with the following:
- .1 the pressure (in bar or kPa) at which it is set to discharge;
  - .2 the allowable tolerance at the discharge pressure, for spring-loaded devices;
  - .3 the reference temperature corresponding to the rated pressure, for frangible discs;

\* See, e.g. CGA S-1.2-2003 *Pressure Relief Device Standards – Part 2 – Cargo and Portable Tanks for Compressed Gases*.



**Chapter 6.7 – Design, construction, inspection and testing of portable tanks & MEGCs**

- .4 the rated flow capacity of the device in standard cubic metres of air per second (m<sup>3</sup>/s); and
- .5 the cross sectional flow areas of the spring-loaded pressure relief devices and frangible discs in mm<sup>2</sup>.

When practicable, the following information shall also be shown:

- .6 the manufacturer's name and relevant catalogue number.

6.7.4.8.2 The rated flow capacity marked on the pressure relief devices shall be determined according to ISO 4126-1:2004 and ISO 4126-7:2004.

**6.7.4.9 Connections to pressure relief devices**

6.7.4.9.1 Connections to pressure relief devices shall be of sufficient size to enable the required discharge to pass unrestricted to the safety device. No stop-valve shall be installed between the shell and the pressure relief devices except when duplicate devices are provided for maintenance or other reasons and the stop-valves serving the devices actually in use are locked open or the stop-valves are interlocked so that the provisions of 6.7.4.7 are always fulfilled. There shall be no obstruction in an opening leading to a vent or pressure relief device which might restrict or cut off the flow from the shell to that device. Pipework to vent the vapour or liquid from the outlet of the pressure relief devices, when used, shall deliver the relieved vapour or liquid to the atmosphere in conditions of minimum back-pressure on the relieving device.

**6.7.4.10 Siting of pressure relief devices**

6.7.4.10.1 Each pressure relief device inlet shall be situated on top of the shell in a position as near the longitudinal and transverse centre of the shell as reasonably practicable. All pressure relief device inlets shall, under maximum filling conditions, be situated in the vapour space of the shell and the devices shall be so arranged as to ensure that the escaping vapour is discharged unrestrictedly. For refrigerated liquefied gases, the escaping vapour shall be directed away from the tank and in such a manner that it cannot impinge upon the tank. Protective devices which deflect the flow of vapour are permissible provided the required relief-device capacity is not reduced.

6.7.4.10.2 Arrangements shall be made to prevent access to the devices by unauthorized persons and to protect the devices from damage caused by the portable tank overturning.

**6.7.4.11 Gauging devices**

6.7.4.11.1 Unless a portable tank is intended to be filled by mass, it shall be equipped with one or more gauging devices. Glass level-gauges and gauges made of other fragile material, which are in direct communication with the contents of the shell, shall not be used.

6.7.4.11.2 A connection for a vacuum gauge shall be provided in the jacket of a vacuum-insulated portable tank.

**6.7.4.12 Portable tank supports, frameworks, lifting and tie-down attachments**

6.7.4.12.1 Portable tanks shall be designed and constructed with a support structure to provide a secure base during transport. The forces specified in 6.7.4.2.12 and the safety factor specified in 6.7.4.2.13 shall be considered in this aspect of the design. Skids, frameworks, cradles or other similar structures are acceptable.

6.7.4.12.2 The combined stresses caused by portable tank mountings (such as cradles, frameworks, etc.) and portable tank lifting and tie-down attachments shall not cause excessive stress in any portion of the tank. Permanent lifting and tie-down attachments shall be fitted to all portable tanks. Preferably they shall be fitted to the portable tank supports but may be secured to reinforcing plates located on the tank at the points of support.

6.7.4.12.3 In the design of supports and frameworks, the effects of environmental corrosion shall be taken into account.

6.7.4.12.4 Forklift pockets shall be capable of being closed off. The means of closing forklift pockets shall be a permanent part of the framework or permanently attached to the framework. Single-compartment portable tanks with a length less than 3.65 m need not have closed-off forklift pockets provided that:

- .1 the tank and all the fittings are well protected from being hit by the forklift blades; and
- .2 the distance between the centres of the forklift pockets is at least half of the maximum length of the portable tank.

6.7.4.12.5 When portable tanks are not protected during transport, according to 4.2.3.3, the shells and service equipment shall be protected against damage to the shell and service equipment resulting from lateral or longitudinal impact or overturning. External fittings shall be protected so as to preclude the release of the shell contents upon impact or overturning of the portable tank on its fittings. Examples of protection include:

- .1 protection against lateral impact, which may consist of longitudinal bars protecting the shell on both sides at the level of the median line;

**Part 6 – Construction and testing of packagings, IBCs, etc.**

- .2 protection of the portable tank against overturning, which may consist of reinforcement rings or bars fixed across the frame;
- .3 protection against rear impact, which may consist of a bumper or frame;
- .4 protection of the shell against damage from impact or overturning by use of an ISO frame in accordance with ISO 1496-3:1995;
- .5 protection of the portable tank from impact or overturning by a vacuum insulation jacket.

**6.7.4.13 Design approval**

6.7.4.13.1 The competent authority or its authorized body shall issue a design approval certificate for any new design of a portable tank. This certificate shall attest that a portable tank has been surveyed by that authority, is suitable for its intended purpose and meets the provisions of this chapter. When a series of portable tanks are manufactured without change in the design, the certificate shall be valid for the entire series. The certificate shall refer to the prototype test report, the refrigerated liquefied gases allowed to be transported, the materials of construction of the shell and jacket and an approval number. The approval number shall consist of the distinguishing sign or mark of the State in whose territory the approval was granted, indicated by the distinguishing sign used on vehicles in international road traffic\* and a registration number. Any alternative arrangements according to 6.7.1.2 shall be indicated on the certificate. A design approval may serve for the approval of smaller portable tanks made of materials of the same kind and thickness, by the same fabrication techniques and with identical supports, equivalent closures and other appurtenances.

6.7.4.13.2 The prototype test report for the design approval shall include at least the following:

- .1 the results of the applicable framework test specified in ISO 1496-3:1995;
- .2 the results of the initial inspection and test in 6.7.4.14.3; and
- .3 the results of the impact test in 6.7.4.14.1, when applicable.

**6.7.4.14 Inspection and testing**

6.7.4.14.1 Portable tanks meeting the definition of *container* in the *International Convention for Safe Containers, 1972* (CSC Convention), as amended, shall not be used unless they are successfully qualified by subjecting a representative prototype of each design to the Dynamic, Longitudinal Impact Test prescribed in the *Manual of Tests and Criteria*, part IV, section 41. This provision only applies to portable tanks which are constructed according to a design approval certificate which has been issued on or after 1 January 2008.

6.7.4.14.2 The tank and items of equipment of each portable tank shall be inspected and tested before being put into service for the first time (initial inspection and test) and thereafter at not more than five-year intervals (5-year periodic inspection and test) with an intermediate periodic inspection and test (2.5-year periodic inspection and test) midway between the 5-year periodic inspections and tests. The 2.5-year periodic inspection and test may be performed within 3 months of the specified date. An exceptional inspection and test shall be performed regardless of the last periodic inspection and test when necessary according to 6.7.4.14.7.

6.7.4.14.3 The initial inspection and test of a portable tank shall include a check of the design characteristics, an internal and external examination of the portable tank shell and its fittings with due regard to the refrigerated liquefied gases to be transported, and a pressure test referring to the test pressures according to 6.7.4.3.2. The pressure test may be performed as a hydraulic test or by using another liquid or gas, with the agreement of the competent authority or its authorized body. Before the portable tank is placed into service, a leakproofness test and a test of the satisfactory operation of all service equipment shall also be performed. When the shell and its fittings have been pressure-tested separately, they shall be subjected together after assembly to a leakproofness test. All welds subject to full stress level shall be inspected during the initial test by radiographic, ultrasonic, or another suitable non-destructive test method. This does not apply to the jacket.

6.7.4.14.4 The 5-year and 2.5-year periodic inspections and tests shall include an external examination of the portable tank and its fittings with due regard to the refrigerated liquefied gases transported, a leakproofness test, a test of the satisfactory operation of all service equipment and a vacuum reading, when applicable. In the case of non-vacuum-insulated tanks, the jacket and insulation shall be removed during the 2.5-year and the 5-year periodic inspections and tests, but only to the extent necessary for a reliable appraisal.

6.7.4.14.5 [Reserved]

6.7.4.14.6 A portable tank may not be filled and offered for transport after the date of expiry of the last 5-year or 2.5-year periodic inspection and test as required by 6.7.4.14.2. However, a portable tank filled prior to the date of expiry of the last periodic inspection and test may be transported for a period not to exceed three months beyond

\* Distinguishing sign of the State of registration used on motor vehicles and trailers in international road traffic, e.g. in accordance with the Geneva Convention on Road Traffic of 1949 or the Vienna Convention on Road Traffic of 1968.



## Chapter 6.7 – Design, construction, inspection and testing of portable tanks &amp; MEGCs

the date of expiry of the last periodic test or inspection. In addition, a portable tank may be transported after the date of expiry of the last periodic test and inspection:

- .1 after emptying but before cleaning, for purposes of performing the next required test or inspection prior to refilling; and
- .2 unless otherwise approved by the competent authority, for a period not to exceed six months beyond the date of expiry of the last periodic test or inspection, in order to allow the return of dangerous goods for proper disposal or recycling. Reference to this exemption shall be mentioned in the transport document.

Except as provided for in this paragraph, portable tanks which have missed the timeframe for their scheduled 5-year or 2.5-year periodic inspection and test may only be filled and offered for transport if a new 5-year periodic inspection and test is performed according to 6.7.4.14.4.

- 6.7.4.14.7** The exceptional inspection and test is necessary when the portable tank shows evidence of damaged or corroded areas, leakage, or any other conditions that indicate a deficiency that could affect the integrity of the portable tank. The extent of the exceptional inspection and test shall depend on the amount of damage or deterioration of the portable tank. It shall include at least the 2.5-year periodic inspection and test according to 6.7.4.14.4.
- 6.7.4.14.8** The internal examination during the initial inspection and test shall ensure that the shell is inspected for pitting, corrosion, or abrasions, dents, distortions, defects in welds or any other conditions that might render the portable tank unsafe for transport.
- 6.7.4.14.9** The external examination shall ensure that:
- .1 the external piping, valves, pressurizing/cooling systems when applicable, and gaskets are inspected for corroded areas, defects, or any other conditions, including leakage, that might render the portable tank unsafe for filling, discharge or transport;
  - .2 there is no leakage at any manhole covers or gaskets;
  - .3 missing or loose bolts or nuts on any flanged connection or blank flange are replaced or tightened;
  - .4 all emergency devices and valves are free from corrosion, distortion and any damage or defect that could prevent their normal operation. Remote closure devices and self-closing stop-valves shall be operated to demonstrate proper operation;
  - .5 required marks on the portable tank are legible and in accordance with the applicable provisions; and
  - .6 the framework, the supports and the arrangements for lifting the portable tank are in satisfactory condition.
- 6.7.4.14.10** The inspections and tests in 6.7.4.14.1, 6.7.4.14.3, 6.7.4.14.4 and 6.7.4.14.7 shall be performed or witnessed by an expert approved by the competent authority or its authorized body. When the pressure test is a part of the inspection and test, the test pressure shall be the one indicated on the data plate of the portable tank. While under pressure, the portable tank shall be inspected for any leaks in the shell, piping or equipment.
- 6.7.4.14.11** In all cases when cutting, burning or welding operations on the shell of a portable tank have been effected, that work shall be to the approval of the competent authority or its authorized body, taking into account the pressure-vessel code used for the construction of the shell. A pressure test to the original test pressure shall be performed after the work is completed.
- 6.7.4.14.12** When evidence of any unsafe condition is discovered, the portable tank shall not be returned to service until it has been corrected and the test is repeated and passed.
- 6.7.4.15** **Marking**
- 6.7.4.15.1** Every portable tank shall be fitted with a corrosion-resistant metal plate permanently attached to the portable tank in a conspicuous place readily accessible for inspection. When for reasons of portable tank arrangements the plate cannot be permanently attached to the shell, the shell shall be marked with at least the information required by the pressure-vessel code. As a minimum, at least the following information shall be marked on the plate by stamping or by any other similar method:
- (a) owner information
    - (i) owner's registration number;
  - (b) manufacturing information
    - (i) country of manufacture;
    - (ii) year of manufacture;
    - (iii) manufacturer's name or mark;
    - (iv) manufacturer's serial number;

**Part 6 – Construction and testing of packagings, IBCs, etc.**

## (c) approval information

- (i) the United Nations packaging symbol:



This symbol shall not be used for any purpose other than certifying that a packaging, a flexible bulk container, a portable tank or a MEGC complies with the relevant requirements in chapters 6.1, 6.2, 6.3, 6.5, 6.6, 6.7 or 6.9;

- (ii) approval country;
  - (iii) authorized body for the design approval;
  - (iv) design approval number;
  - (v) letters “AA”, if the design was approved under alternative arrangements (see 6.7.1.2);
  - (vi) pressure-vessel code to which the shell is designed;
- (d) pressures
- (i) MAWP (in bar gauge or kPa gauge);\*
  - (ii) test pressure (in bar gauge or kPa gauge);\*
  - (iii) initial pressure test date (month and year);
  - (iv) identification mark of the initial pressure test witness;
- (e) temperatures
- (i) minimum design temperature (in °C);\*
- (f) materials
- (i) shell material(s) and material standard reference(s);
  - (ii) equivalent thickness in reference steel (in mm);\*
- (g) capacity
- (i) tank water capacity at 20°C (in litres);\*
- (h) insulation
- (i) either “Thermally insulated” or “Vacuum insulated” (as applicable);
  - (ii) effectiveness of the insulation system (heat influx) (in Watts);\*
- (i) holding times – for each refrigerated liquefied gas permitted to be transported in the portable tank:
- (i) name, in full, of the refrigerated liquefied gas;
  - (ii) reference holding time (in days or hours);\*
  - (iii) initial pressure (in bar gauge or kPa gauge);\*
- △ (iv) maximum allowable mass of gas filled (in kg);\*
- (j) periodic inspections and tests
- (i) type of the most recent periodic test (2.5-year, 5-year or exceptional);
  - (ii) date of the most recent periodic test (month and year);
  - (iii) identification mark of the authorized body who performed or witnessed the most recent test.

\* The unit used shall be indicated.

Chapter 6.7 – Design, construction, inspection and testing of portable tanks & MEGCs

Figure 6.7.4.15.1 – Example of a plate for marking

|   |                                     |               |                  |           |                                      |
|---|-------------------------------------|---------------|------------------|-----------|--------------------------------------|
| Owner's registration number   |                                     |               |                  |           |                                      |
| <b>MANUFACTURING INFORMATION</b>  |                                     |               |                  |           |                                      |
| Country of manufacture  |                                     |               |                  |           |                                      |
| Year of manufacture   |                                     |               |                  |           |                                      |
| Manufacturer  |                                     |               |                  |           |                                      |
| Manufacturer's serial number  |                                     |               |                  |           |                                      |
| <b>APPROVAL INFORMATION</b>   |                                     |               |                  |           |                                      |
|  | Approval country                    |               |                  |           |                                      |
|   | Authorized body for design approval |               |                  |           |                                      |
|   | Design approval number              |               |                  |           | "AA" (if applicable)                 |
| Shell design code (pressure-vessel code)  |                                     |               |                  |           |                                      |
| <b>PRESSURES</b>  |                                     |               |                  |           |                                      |
| MAWP  |                                     |               |                  |           | bar or kPa                           |
| Test pressure   |                                     |               |                  |           | bar or kPa                           |
| Initial pressure test date:   |                                     | (mm/yyyy)     | Witness stamp:   |           |                                      |
| <b>TEMPERATURES</b>   |                                     |               |                  |           |                                      |
| Minimum design temperature  |                                     |               |                  |           | °C                                   |
| <b>MATERIALS</b>  |                                     |               |                  |           |                                      |
| Shell material(s) and material standard reference(s)                              |                                     |               |                  |           |                                      |
| Equivalent thickness in reference steel   |                                     |               |                  |           | mm                                   |
| <b>CAPACITY</b>   |                                     |               |                  |           |                                      |
| Tank water capacity at 20°C   |                                     |               |                  |           | litres                               |
| <b>INSULATION</b>   |                                     |               |                  |           |                                      |
| "Thermally insulated" or "Vacuum insulated" (as applicable)                       |                                     |               |                  |           |                                      |
| Heat influx   |                                     |               |                  |           | Watts                                |
| <b>HOLDING TIMES</b>  |                                     |               |                  |           |                                      |
| △ Refrigerated liquefied gas(es) permitted  | Reference holding time              |               | Initial pressure |           | Maximum allowable mass of gas filled |
|   | days or hours                       |               | bar or kPa       |           | kg                                   |
|   |                                     |               |                  |           |                                      |
|   |                                     |               |                  |           |                                      |
|   |                                     |               |                  |           |                                      |
| <b>PERIODIC INSPECTIONS/TESTS</b>   |                                     |               |                  |           |                                      |
| Test type   | Test date                           | Witness stamp | Test type        | Test date | Witness stamp                        |
|   | (mm/yyyy)                           |               |                  | (mm/yyyy) |                                      |
|   |                                     |               |                  |           |                                      |
|   |                                     |               |                  |           |                                      |
|   |                                     |               |                  |           |                                      |

Part 6 – Construction and testing of packagings, IBCs, etc.

- 6.7.4.15.2 The following information shall be durably marked either on the portable tank itself or on a metal plate firmly secured to the portable tank:
- Name of the owner and the operator
  - Name of the refrigerated liquefied gas being transported (and minimum mean bulk temperature)
  - Maximum permissible gross mass (MPGM) . . . . . kg
  - Unladen (tare) mass . . . . . kg
  - Actual holding time for gas being transported . . . . . days (or hours)
  - Portable tank instruction in accordance with 4.2.5.2.6.

- 6.7.4.15.3 If a portable tank is designed and approved for handling in open seas, the words “OFFSHORE PORTABLE TANK” shall be marked on the identification plate.

**6.7.5 Provisions for the design, construction, inspection and testing of multiple-element gas containers (MEGCs) intended for the transport of non-refrigerated gases**

**6.7.5.1 Definitions**

For the purposes of this section:

*Elements* are cylinders, tubes or bundles of cylinders;

*Leakproofness test* means a test, using gas, subjecting the elements and the service equipment of the MEGC to an effective internal pressure of not less than 20% of the test pressure;

*Manifold* means an assembly of piping and valves connecting the filling and/or discharge openings of the elements;

*Maximum permissible gross mass (MPGM)* means the sum of the tare mass of the MEGC and the heaviest load authorized for transport;

*Service equipment* means measuring instruments and filling, discharge, venting and safety devices;

*Structural equipment* means the reinforcing, fastening, protective and stabilizing members external to the elements.

**6.7.5.2 General design and construction provisions**

- 6.7.5.2.1 The MEGC shall be capable of being filled and discharged without the removal of its structural equipment. It shall possess stabilizing members external to the elements to provide structural integrity for handling and transport. MEGCs shall be designed and constructed with supports to provide a secure base during transport and with lifting and tie-down attachments which are adequate for lifting the MEGC, including when loaded to its maximum permissible gross mass. The MEGC shall be designed to be loaded onto or into a vehicle or ship and shall be equipped with skids, mountings or accessories to facilitate mechanical handling.

- 6.7.5.2.2 MEGCs shall be designed, manufactured and equipped in such a way as to withstand all conditions to which they will be subjected during normal conditions of handling and transport. The design shall take into account the effects of dynamic loading and fatigue.

- 6.7.5.2.3 Elements of an MEGC shall be made of seamless steel or composite construction and be constructed and tested according to chapter 6.2. All of the elements in an MEGC shall be of the same design type.

- 6.7.5.2.4 Elements of MEGCs, fittings and pipework shall be:

- △ .1 compatible with the substances intended to be transported (for gases, see ISO 11114-1:2020 and ISO 11114-2:2021); or
- .2 properly passivated or neutralized by chemical reaction.

- 6.7.5.2.5 Contact between dissimilar metals which could result in damage by galvanic action shall be avoided.

- 6.7.5.2.6 The materials of the MEGC, including any devices, gaskets, and accessories, shall not adversely affect the gases intended for transport in the MEGC.

- 6.7.5.2.7 MEGCs shall be designed to withstand, without loss of contents, at least the internal pressure due to the contents, and the static, dynamic and thermal loads during normal conditions of handling and transport. The design shall demonstrate that the effects of fatigue, caused by repeated application of these loads through the expected life of the multiple-element gas container, have been taken into account.



## Chapter 6.7 – Design, construction, inspection and testing of portable tanks &amp; MEGCs

- 6.7.5.2.8 MEGCs and their fastenings shall, under the maximum permissible load, be capable of withstanding the following separately applied static forces:
- .1 in the direction of travel: twice the MPGM multiplied by the acceleration due to gravity (g);\*
  - .2 horizontally at right angles to the direction of travel: the MPGM (when the direction of travel is not clearly determined, the forces shall be equal to twice the MPGM) multiplied by the acceleration due to gravity (g);\*
  - .3 vertically upwards: the MPGM multiplied by the acceleration due to gravity (g);\* and
  - .4 vertically downwards: twice the MPGM (total loading including the effect of gravity) multiplied by the acceleration due to gravity (g).\*
- 6.7.5.2.9 Under the forces defined above, the stress at the most severely stressed point of the elements shall not exceed the values given in either the relevant standards of 6.2.2.1 or, if the elements are not designed, constructed and tested according to those standards, in the technical code or standard recognized or approved by the competent authority of the country of use (see 6.2.3.1).
- 6.7.5.2.10 Under each of the forces in 6.7.5.2.8, the safety factor for the framework and fastenings to be observed shall be as follows:
- .1 for steels having a clearly defined yield point, a safety factor of 1.5 in relation to the guaranteed yield strength; or
  - .2 for steels with no clearly defined yield point, a safety factor of 1.5 in relation to the guaranteed 0.2% proof strength and, for austenitic steels, the 1% proof strength.
- 6.7.5.2.11 MEGCs intended for the transport of flammable gases shall be capable of being electrically earthed.
- 6.7.5.2.12 The elements shall be secured in a manner that prevents undesired movement in relation to the structure and the concentration of harmful localized stresses.
- 6.7.5.3 Service equipment**
- 6.7.5.3.1 Service equipment shall be configured or designed to prevent damage that could result in the release of the pressure receptacle contents during normal conditions of handling and transport. When the connection between the frame and the elements allows relative movement between the sub-assemblies, the equipment shall be so fastened as to permit such movement without damage to working parts. The manifolds, the discharge fittings (pipe sockets, shut-off devices), and the stop-valves shall be protected from being wrenched off by external forces. Manifold piping leading to shut-off valves shall be sufficiently flexible to protect the valves and the piping from shearing, or releasing the pressure receptacle contents. The filling and discharge devices (including flanges or threaded plugs) and any protective caps shall be capable of being secured against unintended opening.
- 6.7.5.3.2 Each element intended for the transport of gases of class 2.3 shall be fitted with a valve. The manifold for liquefied gases of class 2.3 shall be so designed that the elements can be filled separately and be kept isolated by a valve capable of being sealed. For the transport of gases of class 2.1, the elements shall be divided into groups of not more than 3,000 L each isolated by a valve.
- 6.7.5.3.3 For filling and discharge openings of the MEGC, two valves in series shall be placed in an accessible position on each discharge and filling pipe. One of the valves may be a non-return valve. The filling and discharge devices may be fitted to a manifold. For sections of piping which can be closed at both ends and where a liquid product can be trapped, a pressure relief valve shall be provided to prevent excessive pressure build-up. The main isolation valves on an MEGC shall be clearly marked to indicate their directions of closure. Each stop-valve or other means of closure shall be designed and constructed to withstand a pressure equal to or greater than 1.5 times the test pressure of the MEGC. All stop-valves with screwed spindles shall close by a clockwise motion of the handwheel. For other stop-valves, the positions (open and closed) and direction of closure shall be clearly indicated. All stop-valves shall be designed and positioned to prevent unintentional opening. Ductile metals shall be used in the construction of valves or accessories.
- 6.7.5.3.4 Piping shall be designed, constructed and installed so as to avoid damage due to expansion and contraction, mechanical shock and vibration. Joints in tubing shall be brazed or have an equally strong metal union. The melting point of brazing materials shall be no lower than 525°C. The rated pressure of the service equipment and of the manifold shall be not less than two thirds of the test pressure of the elements.
- 6.7.5.4 Pressure relief devices**
- 6.7.5.4.1 The elements of MEGCs used for the transport of UN 1013 carbon dioxide and UN 1070 nitrous oxide shall be divided into groups of not more than 3,000 L each isolated by a valve. Each group shall be fitted with one

\* For calculation purposes,  $g = 9.81 \text{ m/s}^2$ .

**Part 6 – Construction and testing of packagings, IBCs, etc.**

or more pressure relief devices. If so required by the competent authority of the country of use, MEGCs for other gases shall be fitted with pressure relief devices as specified by that competent authority.

**6.7.5.4.2** When pressure relief devices are fitted, every element or group of elements of an MEGC that can be isolated shall then be fitted with one or more pressure relief devices. Pressure relief devices shall be of a type that will resist dynamic forces, including liquid surge, and shall be designed to prevent the entry of foreign matter, the leakage of gas and the development of any dangerous excess pressure.

**6.7.5.4.3** MEGCs used for the transport of certain non-refrigerated gases identified in instruction T50 in 4.2.5.2.6 may have a pressure relief device as required by the competent authority of the country of use. Unless an MEGC in dedicated service is fitted with an approved pressure relief device constructed of materials compatible with the load, such a device shall comprise a frangible disc preceding a spring-loaded device. The space between the frangible disc and the spring-loaded device may be equipped with a pressure gauge or a suitable tell-tale indicator. This arrangement permits the detection of disc rupture, pinholing or leakage which could cause a malfunction of the pressure relief device. The frangible disc shall rupture at a nominal pressure 10% above the start-to-discharge pressure of the spring-loaded device.

**6.7.5.4.4** In the case of multi-purpose MEGCs used for the transport of low-pressure liquefied gases, the pressure relief devices shall open at a pressure as specified in 6.7.3.7.1 for the gas having the highest maximum allowable working pressure of the gases allowed to be transported in the MEGC.

**6.7.5.5 Capacity of pressure relief devices**

**6.7.5.5.1** The combined delivery capacity of the pressure relief devices when fitted shall be sufficient that, in the event of complete fire engulfment of the MEGC, the pressure (including accumulation) inside the elements does not exceed 120% of the set pressure of the pressure relief device. The formula provided in CGA S-1.2-2003 *Pressure Relief Device Standards, Part 2, Cargo and Portable Tanks for Compressed Gases* shall be used to determine the minimum total flow capacity for the system of pressure relief devices. CGA S-1.1-2003 *Pressure Relief Device Standards, Part 1, Cylinders for Compressed Gases* may be used to determine the relief capacity of individual elements. Spring-loaded pressure relief devices may be used to achieve the full relief capacity prescribed in the case of low-pressure liquefied gases. In the case of multi-purpose MEGCs, the combined delivery capacity of the pressure relief devices shall be taken for the gas which requires the highest delivery capacity of the gases allowed to be transported in the MEGC.

**6.7.5.5.2** To determine the total required capacity of the pressure relief devices installed on the elements for the transport of liquefied gases, the thermodynamic properties of the gas shall be considered (see, for example, CGA S-1.2-2003 *Pressure Relief Device Standards, Part 2, Cargo and Portable Tanks for Compressed Gases* for low-pressure liquefied gases and CGA S-1.1-2003 *Pressure Relief Device Standards, Part 1, Cylinders for Compressed Gases* for high-pressure liquefied gases).

**6.7.5.6 Marking of pressure relief devices**

**6.7.5.6.1** Pressure relief devices shall be clearly and permanently marked with the following:

- (a) the manufacturer's name and relevant catalogue number;
- (b) the set pressure and/or the set temperature;
- (c) the date of the last test; and
- (d) the cross sectional flow areas of the spring-loaded pressure relief devices and frangible discs in mm<sup>2</sup>.

**6.7.5.6.2** The rated flow capacity marked on spring-loaded pressure relief devices for low-pressure liquefied gases shall be determined according to ISO 4126-1:2004 and ISO 4126-7:2004.

**6.7.5.7 Connections to pressure relief devices**

**6.7.5.7.1** Connections to pressure relief devices shall be of sufficient size to enable the required discharge to pass unrestricted to the pressure relief device. No stop-valve shall be installed between the element and the pressure relief devices, except when duplicate devices are provided for maintenance or other reasons, and the stop-valves serving the devices actually in use are locked open, or the stop-valves are interlocked so that at least one of the duplicate devices is always operable and capable of meeting the requirements of 6.7.5.5. There shall be no obstruction in an opening leading to or leaving from a vent or pressure relief device which might restrict or cut off the flow from the element to that device. The opening through all piping and fittings shall have at least the same flow area as the inlet of the pressure relief device to which it is connected. The nominal size of the discharge piping shall be at least as large as that of the pressure relief device outlet. Vents from the pressure relief devices, when used, shall deliver the relieved vapour or liquid to the atmosphere in conditions of minimum back-pressure on the relieving device.



## Chapter 6.7 – Design, construction, inspection and testing of portable tanks &amp; MEGCs

**6.7.5.8 Siting of pressure relief devices**

**6.7.5.8.1** Each pressure relief device shall, under maximum filling conditions, be in communication with the vapour space of the elements for the transport of liquefied gases. The devices, when fitted, shall be so arranged as to ensure that the escaping vapour is discharged upwards and unrestrictedly so as to prevent any impingement of escaping gas or liquid upon the MEGC, its elements or personnel. For flammable, pyrophoric and oxidizing gases, the escaping gas shall be directed away from the element in such a manner that it cannot impinge upon the other elements. Heat-resistant protective devices which deflect the flow of gas are permissible provided the required pressure relief device capacity is not reduced.

**6.7.5.8.2** Arrangements shall be made to prevent access to the pressure relief devices by unauthorized persons and to protect the devices from damage caused by the MEGC overturning.

**6.7.5.9 Gauging devices**

**6.7.5.9.1** When an MEGC is intended to be filled by mass, it shall be equipped with one or more gauging devices. Level-gauges made of glass or other fragile material shall not be used.

**6.7.5.10 MEGC supports, frameworks, lifting and tie-down attachments**

**6.7.5.10.1** MEGCs shall be designed and constructed with a support structure to provide a secure base during transport. The forces specified in 6.7.5.2.8 and the safety factor specified in 6.7.5.2.10 shall be considered in this aspect of the design. Skids, frameworks, cradles or other similar structures are acceptable.

**6.7.5.10.2** The combined stresses caused by element mountings (e.g. cradles, frameworks, etc.) and MEGC lifting and tie-down attachments shall not cause excessive stress in any element. Permanent lifting and tie-down attachments shall be fitted to all MEGCs. In no case shall mountings or attachments be welded onto the elements.

**6.7.5.10.3** In the design of supports and frameworks, the effects of environmental corrosion shall be taken into account.

**6.7.5.10.4** When MEGCs are not protected during transport, according to 4.2.4.3, the elements and service equipment shall be protected against damage resulting from lateral or longitudinal impact or overturning. External fittings shall be protected so as to preclude the release of the elements' contents upon impact or overturning of the MEGC on its fittings. Particular attention shall be paid to the protection of the manifold. Examples of protection include:

- .1 protection against lateral impact, which may consist of longitudinal bars;
- .2 protection against overturning, which may consist of reinforcement rings or bars fixed across the frame;
- .3 protection against rear impact, which may consist of a bumper or frame;
- .4 protection of the elements and service equipment against damage from impact or overturning by use of an ISO frame in accordance with the relevant provisions of ISO 1496-3:1995.

**6.7.5.11 Design approval**

**6.7.5.11.1** The competent authority or its authorized body shall issue a design approval certificate for any new design of an MEGC. This certificate shall attest that the MEGC has been surveyed by that authority, is suitable for its intended purpose and meets the requirements of this chapter, the applicable provisions for gases of chapter 4.1 and of packing instruction P200. When a series of MEGCs are manufactured without change in the design, the certificate shall be valid for the entire series. The certificate shall refer to the prototype test report, the materials of construction of the manifold, the standards to which the elements are made and an approval number. The approval number shall consist of the distinguishing sign or mark of the country granting the approval, indicated by the distinguishing sign used on vehicles in international road traffic\* and a registration number. Any alternative arrangements according to 6.7.1.2 shall be indicated on the certificate. A design approval may serve for the approval of smaller MEGCs made of materials of the same type and thickness, by the same fabrication techniques and with identical supports, equivalent closures and other appurtenances.

**6.7.5.11.2** The prototype test report for the design approval shall include at least the following:

- .1 the results of the applicable framework test specified in ISO 1496-3:1995;
- .2 the results of the initial inspection and test specified in 6.7.5.12.3;
- .3 the results of the impact test specified in 6.7.5.12.1; and
- .4 certification documents verifying that the cylinders and tubes comply with the applicable standards.

\* Distinguishing sign of the State of registration used on motor vehicles and trailers in international road traffic, e.g. in accordance with the Geneva Convention on Road Traffic of 1949 or the Vienna Convention on Road Traffic of 1968.



**Part 6 – Construction and testing of packagings, IBCs, etc.****6.7.5.12 Inspection and testing**

- 6.7.5.12.1** MEGCs meeting the definition of *container* in the *International Convention for Safe Containers, 1972* (CSC Convention), as amended, shall not be used unless they are successfully qualified by subjecting a representative prototype of each design to the Dynamic, Longitudinal Impact Test prescribed in the *Manual of Tests and Criteria*, part IV, section 41. This provision only applies to MEGCs which are constructed according to a design approval certificate which has been issued on or after 1 January 2008.
- 6.7.5.12.2** The elements and items of equipment of each MEGC shall be inspected and tested before being put into service for the first time (initial inspection and test). Thereafter, MEGCs shall be inspected at no more than five-year intervals (5-year periodic inspection). An exceptional inspection and test shall be performed, regardless of the last periodic inspection and test, when necessary according to 6.7.5.12.5.
- 6.7.5.12.3** The initial inspection and test of an MEGC shall include a check of the design characteristics, an external examination of the MEGC and its fittings with due regard to the gases to be transported, and a pressure test performed at the test pressures according to packing instruction P200. The pressure test of the manifold may be performed as a hydraulic test or by using another liquid or gas with the agreement of the competent authority or its authorized body. Before the MEGC is placed into service, a leakproofness test and a test of the satisfactory operation of all service equipment shall also be performed. When the elements and their fittings have been pressure-tested separately, they shall be subjected together after assembly to a leakproofness test.
- 6.7.5.12.4** The 5-year periodic inspection and test shall include an external examination of the structure, the elements and the service equipment in accordance with 6.7.5.12.6. The elements and the piping shall be tested at the periodicity specified in packing instruction P200 and in accordance with the provisions described in 6.2.1.6. When the elements and equipment have been pressure-tested separately, they shall be subjected together after assembly to a leakproofness test.
- 6.7.5.12.5** An exceptional inspection and test is necessary when the MEGC shows evidence of damaged or corroded areas, leakage, or other conditions that indicate a deficiency that could affect the integrity of the MEGC. The extent of the exceptional inspection and test shall depend on the amount of damage or deterioration of the MEGC. It shall include at least the examinations required under 6.7.5.12.6.
- 6.7.5.12.6** The examinations shall ensure that:
- .1 the elements are inspected externally for pitting, corrosion, abrasions, dents, distortions, defects in welds or any other conditions, including leakage, that might render the MEGC unsafe for transport;
  - .2 the piping, valves, and gaskets are inspected for corroded areas, defects, and other conditions, including leakage, that might render the MEGC unsafe for filling, discharge or transport;
  - .3 missing or loose bolts or nuts on any flanged connection or blank flange are replaced or tightened;
  - .4 all emergency devices and valves are free from corrosion, distortion and any damage or defect that could prevent their normal operation. Remote closure devices and self-closing stop-valves shall be operated to demonstrate proper operation;
  - .5 required marks on the MEGC are legible and in accordance with the applicable requirements; and
  - .6 the framework, the supports and the arrangements for lifting the MEGC are in satisfactory condition.
- 6.7.5.12.7** The inspections and tests in 6.7.5.12.1, 6.7.5.12.3, 6.7.5.12.4 and 6.7.5.12.5 shall be performed or witnessed by a body authorized by the competent authority. When the pressure test is a part of the inspection and test, the test pressure shall be the one indicated on the data plate of the MEGC. While under pressure, the MEGC shall be inspected for any leaks in the elements, piping or equipment.
- 6.7.5.12.8** When evidence of any unsafe condition is discovered, the MEGC shall not be returned to service until it has been corrected and the applicable tests and verifications are passed.

**6.7.5.13 Marking**

- 6.7.5.13.1** Every MEGC shall be fitted with a corrosion-resistant metal plate permanently attached to the MEGC in a conspicuous place readily accessible for inspection. The metal plate shall not be affixed to the elements. The elements shall be marked in accordance with chapter 6.2. As a minimum, at least the following information shall be marked on the plate by stamping or by any other similar method:
- (a) owner information
    - (i) owner's registration number;
  - (b) manufacturing information
    - (i) country of manufacture;
    - (ii) year of manufacture;
    - (iii) manufacturer's name or mark;

Chapter 6.7 – Design, construction, inspection and testing of portable tanks & MEGCs

- (iv) manufacturer's serial number;
- (c) approval information
  - (i) the United Nations packaging symbol:



This symbol shall not be used for any purpose other than certifying that a packaging, a flexible bulk container, a portable tank or a MEGC complies with the relevant requirements in chapters 6.1, 6.2, 6.3, 6.5, 6.6, 6.7 or 6.9;

- (ii) approval country;
  - (iii) authorized body for the design approval;
  - (iv) design approval number;
  - (v) letters "AA", if the design was approved under alternative arrangements (see 6.7.1.2);
- (d) pressures
  - (i) test pressure (in bar gauge);\*
  - (ii) initial pressure test date (month and year);
  - (iii) identification mark of the initial pressure test witness;
- (e) temperatures
  - (i) design temperature range (in °C);\*
- (f) elements/capacity
  - (i) number of elements;
  - (ii) total water capacity (in litres);\*
- (g) periodic inspections and tests
  - (i) type of the most recent periodic test (5-year or exceptional);
  - (ii) date of the most recent periodic test (month and year);
  - (iii) identification mark of the authorized body who performed or witnessed the most recent test.

\* The unit used shall be indicated.

Part 6 – Construction and testing of packagings, IBCs, etc.

Figure 6.7.5.13.1 – Example of a plate for marking

|   |                                     |                |           |           |                      |          |
|---|-------------------------------------|----------------|-----------|-----------|----------------------|----------|
| Owner's registration number   |                                     |                |           |           |                      |          |
| <b>MANUFACTURING INFORMATION</b>  |                                     |                |           |           |                      |          |
| Country of manufacture  |                                     |                |           |           |                      |          |
| Year of manufacture   |                                     |                |           |           |                      |          |
| Manufacturer  |                                     |                |           |           |                      |          |
| Manufacturer's serial number  |                                     |                |           |           |                      |          |
| <b>APPROVAL INFORMATION</b>   |                                     |                |           |           |                      |          |
|  | Approval country                    |                |           |           |                      |          |
|   | Authorized body for design approval |                |           |           |                      |          |
|   | Design approval number              |                |           |           | "AA" (if applicable) |          |
| <b>PRESSURES</b>  |                                     |                |           |           |                      |          |
| Test pressure   |                                     |                |           |           |                      | bar      |
| Initial pressure test date:   | (mm/yyyy)                           | Witness stamp: |           |           |                      |          |
| <b>TEMPERATURES</b>   |                                     |                |           |           |                      |          |
| Design temperature range  |                                     |                |           |           |                      | °C to °C |
| <b>ELEMENTS/CAPACITY</b>  |                                     |                |           |           |                      |          |
| Number of elements  |                                     |                |           |           |                      |          |
| Total water capacity  |                                     |                |           |           |                      | litres   |
| <b>PERIODIC INSPECTIONS/TESTS</b>   |                                     |                |           |           |                      |          |
| Test type   | Test date                           | Witness stamp  | Test type | Test date | Witness stamp        |          |
|   | (mm/yyyy)                           |                |           | (mm/yyyy) |                      |          |
|   |                                     |                |           |           |                      |          |
|   |                                     |                |           |           |                      |          |
|   |                                     |                |           |           |                      |          |

6.7.5.13.2 The following information shall be durably marked on a metal plate firmly secured to the MEGC:

- Name of the operator
- Maximum permissible load mass . . . . . kg
- Working pressure at 15°C: . . . . . bar gauge
- Maximum permissible gross mass (MPGM) . . . . . kg
- Unladen (tare) mass . . . . . kg

6

## Chapter 6.8

### *Provisions for road tank vehicles and road gas elements vehicles*

#### 6.8.1 General

##### 6.8.1.1 Tank and elements support frameworks, fitting and tie-down attachments\*

6.8.1.1.1 Road tank vehicles and road gas elements vehicles shall be designed and manufactured with supports to provide a secure base during transport and with suitable tie-down attachments. The tie-down attachments shall be located on the tank or elements support, or vehicle structure in such a manner that the suspension system is not left in free play.

6.8.1.1.2 Tanks shall be carried only on vehicles whose fastenings are capable, in conditions of maximum permissible loading of the tanks, of absorbing the forces specified in 6.7.2.2.12, 6.7.3.2.9 and 6.7.4.2.12.

#### 6.8.2 Road tank vehicles for long international voyages for substances of classes 3 to 9

##### 6.8.2.1 Design and construction

6.8.2.1.1 A road tank vehicle for long international voyages shall be fitted with a tank complying with the provisions of chapters 4.2 and 6.7 and shall comply with the relevant provisions for tank supports, frameworks, lifting and tie-down attachments,\* except for the provisions for forklift pockets, and in addition comply with the provisions of 6.8.1.1.1.

##### 6.8.2.2 Approval, testing and marking

6.8.2.2.1 For approval, testing and marking of the tank, see 6.7.2.

6.8.2.2.2 The tank supports and tie-down attachments\* of vehicles for long international voyages shall be included in the visual external inspection provided for in 6.7.2.19.

6.8.2.2.3 The vehicle of a road tank vehicle shall be tested and inspected in accordance with the road transport provisions of the competent authority of the country in which the vehicle is operated.

#### 6.8.3 Road tank vehicles and road gas elements vehicles for short international voyages

##### 6.8.3.1 Road tank vehicles for substances of classes 3 to 9 (IMO type 4)

###### 6.8.3.1.1 *General provisions*

6.8.3.1.1.1 An IMO type 4 tank shall comply with either:

- .1 the provisions of 6.8.2; or
- .2 the provisions of 6.8.3.1.2 and 6.8.3.1.3.

###### 6.8.3.1.2 *Design and construction*

6.8.3.1.2.1 An IMO type 4 tank shall comply with the provisions of 6.7.2, with the exception of:

- .1 6.7.2.3.2; however, they shall have been subjected to a test pressure not less than that specified according to the appropriate tank instruction assigned to the substance;

\* See also resolution MSC.479(102) of 11 November 2020, *Revised guidelines for securing arrangements for the transport of road vehicles on ro-ro ships*.

**Part 6 – Construction and testing of packagings, IBCs, etc.**

- .2 6.7.2.4; however, the thickness of cylindrical portions and ends in reference steel shall be:
    - .1 not more than 2 mm thinner than the thickness specified according to the appropriate tank instruction assigned to the substance;
    - .2 subject to an absolute minimum thickness of 4 mm of reference steel; and
    - .3 for other materials, subject to an absolute minimum thickness of 3 mm;
  - .3 6.7.2.2.13; however, the safety factor shall be not less than 1.3;
  - .4 6.7.2.2.1 to 6.7.2.2.7; however, the materials of construction shall comply with the provisions of the competent authority for road transport;
  - .5 6.7.2.5.1; however, the protection of valves and accessories shall comply with the provisions of the competent authority for road transport;
  - .6 6.7.2.5.3; however, IMO type 4 tanks shall be provided with manholes or other openings in the tank which comply with the provisions of the competent authority for road transport;
  - .7 6.7.2.5.2 and 6.7.2.5.4; however, tank nozzles and external fittings shall comply with the provisions of the competent authority for road transport;
  - .8 6.7.2.6; however, IMO type 4 tanks with bottom openings shall not be used for substances for which bottom openings are not permitted in the appropriate tank instruction assigned to the substance. In addition, existing openings and hand inspection holes shall be either closed by bolted flanges mounted both internally and externally, fitted with product-compatible gaskets, or by welding as specified in 6.7.2.6.1. The closing of openings and hand inspection holes shall be approved by the competent authority for sea transport;
  - .9 6.7.2.7 to 6.7.2.15; however, IMO type 4 tanks shall be fitted with pressure relief devices of the type required according to the appropriate tank instruction assigned to the substance. The devices shall be acceptable to the competent authority for the road transport for the substances to be transported. The start-to-discharge pressure of the spring-loaded pressure relief devices shall in no case be less than the maximum allowable working pressure, nor greater than 25% above that pressure; and
  - .10 6.7.2.17; however, tank supports on permanently attached IMO type 4 tanks shall comply with the provisions of the competent authority for road transport.
- 6.8.3.1.2.2 For IMO type 4 tanks, the maximum effective gauge pressure developed by the substances to be transported shall not exceed the maximum allowable working pressure of the tank.
- 6.8.3.1.3 **Approval, testing and marking**
- 6.8.3.1.3.1 IMO type 4 tanks shall be approved for road transport by the competent authority.
- 6.8.3.1.3.2 The competent authority for sea transport shall issue additionally, in respect of an IMO type 4 tank, a certificate attesting compliance with the relevant design, construction and equipment provisions of this subsection and the special provisions for certain substances, as applicable.
- 6.8.3.1.3.3 IMO type 4 tanks shall be periodically tested and inspected in accordance with the provisions of the competent authority for road transport.
- 6.8.3.1.3.4 An IMO type 4 tank shall be marked in accordance with 6.7.2.20. However, where the marking required by the competent authority for road transport is substantially in agreement with that of 6.7.2.20, it will be sufficient to endorse the metal plate attached to the IMO type 4 tank with “IMO 4”.
- 6.8.3.1.3.5 IMO type 4 tanks which are not permanently attached to the chassis shall be marked “IMO type 4” in letters at least 32 mm high.
- 6.8.3.2 **Road tank vehicles for non-refrigerated liquefied gases of class 2 (IMO type 6)**
- 6.8.3.2.1 **General provisions**
- 6.8.3.2.1.1 An IMO type 6 tank shall comply with either:
  - .1 the provisions of 6.7.3; or
  - .2 the provisions of 6.8.3.2.2 and 6.8.3.2.3.
- 6.8.3.2.1.2 For an IMO type 6 tank, the design temperature range is defined in 6.7.3.1. The temperature to be taken is to be agreed by the competent authority for road transport.
- 6.8.3.2.2 **Design and construction**
- 6.8.3.2.2.1 An IMO type 6 tank shall comply with the provisions of 6.7.3, with the exception of:
  - .1 the safety factor of 1.5 in 6.7.3.2.10; however, the safety factor shall not be less than 1.3;

## Chapter 6.8 – Provisions for road tank vehicles and road gas elements vehicles

- .2 6.7.3.5.7;
  - .3 6.7.3.6.1, if bottom openings are approved by the competent authority for sea transport;
  - .4 6.7.3.7.1; however, the devices shall open at a pressure not less than the MAWP and be fully open at a pressure not exceeding the test pressure of the tank;
  - .5 6.7.3.8, if the delivery capacity of the pressure relief devices is approved by the competent authorities for sea and road transport;
  - .6 the location of the pressure relief device inlets in 6.7.3.11.1, which need not be in the longitudinal centre of the shell;
  - .7 the provisions for forklift pockets; and
  - .8 6.7.3.13.5.
- 6.8.3.2.2.2 If the landing legs of an IMO type 6 tank are to be used as support structure, the loads specified in 6.7.3.2.9 shall be taken into account in their design and method of attachment. Any bending stress induced in the shell as a result of this manner of support shall also be included in the design calculations.
- 6.8.3.2.2.3 Securing arrangements (tie-down attachments) shall be fitted to the tank support structure and the towing vehicle of an IMO type 6 tank. Semi-trailers unaccompanied by a towing vehicle shall be accepted for shipment only if the trailer supports and the securing arrangements and the position of stowage are agreed by the competent authority for sea transport, unless the approved Cargo Securing Manual includes this arrangement.
- 6.8.3.2.3 **Approval, testing and marking**
- 6.8.3.2.3.1 IMO type 6 tanks shall be approved for road transport by the competent authority for road transport.
- 6.8.3.2.3.2 The competent authority for sea transport shall issue additionally, in respect of an IMO type 6 tank, a certificate attesting compliance with the relevant design, construction and equipment provisions of this chapter and, where appropriate, the special provisions for the gases listed in the Dangerous Goods List. The certificate shall list the gases allowed to be transported.
- 6.8.3.2.3.3 An IMO type 6 tank shall be periodically tested and inspected in accordance with the provisions of the competent authority for road transport.
- 6.8.3.2.3.4 An IMO type 6 tank shall be marked in accordance with 6.7.3.16. However, where the marking required by the competent authority for road transport is substantially in agreement with that of 6.7.3.16.1, it will be sufficient to endorse the metal plate attached to the IMO type 6 tank with "IMO 6".
- 6.8.3.3 **Road tank vehicles for refrigerated liquefied gases of class 2 (IMO type 8)**
- 6.8.3.3.1 **General provisions**
- 6.8.3.3.1.1 An IMO type 8 tank shall comply with either:
- .1 the provisions of 6.7.4; or
  - .2 the provisions of 6.8.3.3.2 and 6.8.3.3.3.
- 6.8.3.3.1.2 An IMO type 8 tank shall not be offered for transport by sea in a condition that would lead to venting during the voyage under normal conditions of transport.
- 6.8.3.3.2 **Design and construction**
- 6.8.3.3.2.1 An IMO type 8 tank shall comply with the provisions of 6.7.4, with the exception:
- .1 that aluminium jackets may be used, with the approval of the competent authority for sea transport;
  - .2 that IMO type 8 tanks may have a shell thickness less than 3 mm, subject to the approval of the competent authority for sea transport;
  - .3 that for IMO type 8 tanks used for non-flammable refrigerated gases, one of the valves may be replaced by a frangible disc. The frangible disc shall rupture at a nominal pressure equal to the test pressure;
  - .4 of the provisions of 6.7.4.7.3 for the combined capacity of all pressure relief devices under complete fire-engulfment conditions;
  - .5 of the safety factor of 1.5 in 6.7.4.2.13; however, the safety factor shall not be less than 1.3;
  - .6 of 6.7.4.8; and
  - .7 of the provisions for forklift pockets.
- 6.8.3.3.2.2 If the landing legs of an IMO type 8 tank are to be used as support structure, the loads agreed as in 6.7.4.2.12 shall be taken into account in their design and method of attachment. Bending stress induced in the shell as a result of this manner of support shall be included in design calculations.

**Part 6 – Construction and testing of packagings, IBCs, etc.**

- 6.8.3.3.2.3 Securing arrangements (tie-down attachments) shall be fitted to the tank support structure and the towing vehicle of an IMO type 8 tank. Semi-trailers unaccompanied by a towing vehicle shall be accepted for shipment only if the trailer supports and the securing arrangements and the position of stowage are agreed by the competent authority for sea transport, unless the approved Cargo Securing Manual includes this arrangement.
- 6.8.3.3.3 **Approval, testing and marking**
- 6.8.3.3.3.1 IMO type 8 tanks shall be approved for road transport by the competent authority for road transport.
- 6.8.3.3.3.2 The competent authority for sea transport shall issue additionally, in respect of an IMO type 8 tank, a certificate attesting compliance with the relevant design, construction and equipment provisions of this subsection and, where appropriate, the special tank type provisions for the gases in the Dangerous Goods List. The certificate shall list the gases allowed to be transported.
- 6.8.3.3.3.3 IMO type 8 tanks shall be periodically tested and inspected in accordance with the provisions of the competent authority for road transport.
- 6.8.3.3.3.4 IMO type 8 tanks shall be marked in accordance with 6.7.4.15. However, where the marking required by the competent authority for road transport is substantially in agreement with that of 6.7.4.15.1, it will be sufficient to endorse the metal plate attached to the IMO type 8 tank with “IMO 8”; the reference to holding time may be omitted.
- 6.8.3.4 **Road gas elements vehicles for compressed gases of class 2 (IMO Type 9)**
- 6.8.3.4.1 **General provisions**
- 6.8.3.4.1.1 An IMO type 9 tank shall comply with the provisions of 6.8.3.4.2 and 6.8.3.4.3.
- 6.8.3.4.1.2 An IMO type 9 tank shall not be offered for transport by sea in a condition that would lead to venting during the voyage under normal conditions of transport.
- 6.8.3.4.2 **Design and construction**
- 6.8.3.4.2.1 An IMO type 9 tank shall comply with the provisions of 6.7.5 with the exception that the horizontal forces at right angles to the direction of travel shall be the MPGM multiplied by the acceleration due to gravity (g);\* and that the inspection and testing shall be in accordance with the competent authority where the road gas elements vehicle is approved.
- 6.8.3.4.2.2 If the landing legs of an IMO type 9 tank are to be used as support structure, the loads specified in 6.7.5.2.8 shall be taken into account in their design and method of attachment. Any bending stress induced in the shell or the elements as a result of this manner of support shall also be included in the design calculations.
- 6.8.3.4.2.3 Securing arrangements (tie-down attachments) shall be fitted to the road gas elements vehicle support structure and the towing vehicle of an IMO type 9 tank. Semi-trailers unaccompanied by a towing vehicle shall be accepted for shipment only if the trailer supports and the securing arrangements and the position of stowage are agreed by the competent authority for sea transport, unless the approved Cargo Securing Manual includes this arrangement.
- 6.8.3.4.3 **Approval, testing and marking**
- 6.8.3.4.3.1 IMO type 9 tanks shall be approved for road transport by the competent authority for road transport.
- 6.8.3.4.3.2 The competent authority for sea transport shall issue additionally, in respect of an IMO type 9 tank, a certificate attesting compliance with the relevant design, construction and equipment provisions of this chapter and, where appropriate, the special provisions for the gases listed in the Dangerous Goods List. The certificate shall list the gases allowed to be transported.
- 6.8.3.4.3.3 An IMO type 9 tank shall be periodically tested and inspected in accordance with the provisions of the competent authority for road transport where the road gas elements vehicle is approved.
- 6.8.3.4.3.4 An IMO type 9 tank shall be marked in accordance with 6.7.5.13, as applicable. However, where the marking required by the competent authority for road transport is substantially in agreement with that of 6.7.5.13.1, it will be sufficient to endorse the metal plate attached to the IMO type 9 tank with “IMO 9”.

\* For calculation purposes,  $g = 9.81 \text{ m/s}^2$ .



## Chapter 6.9

### *Provisions for the design, construction, inspection and testing of bulk containers*

**Note:** Sheeted bulk containers (BK1) shall not be used for sea transport, except as indicated in 4.3.3.

#### 6.9.1 Definitions

For the purposes of this section:

*Closed bulk container* means a totally closed bulk container having a rigid roof, sidewalls, end walls and floor (including hopper-type bottoms), including bulk containers with an opening roof, or side or end wall that can be closed during transport. Closed bulk container may be equipped with openings to allow for the exchange of vapours and gases with air and which prevent, under normal conditions of transport, the release of solid contents as well as the penetration of rain and splash water.

*Flexible bulk container* means a flexible container with a capacity not exceeding 15 m<sup>3</sup> and includes liners and attached handling devices and service equipment.

*Sheeted bulk container* means an open-top bulk container with rigid bottom (including hopper-type bottom), side and end walls and a non-rigid covering.

#### 6.9.2 Application and general provisions

6.9.2.1 Bulk containers and their service and structural equipment shall be designed and constructed to withstand, without loss of contents, the internal pressure of the contents and the stresses of normal handling and transport.

6.9.2.2 Where a discharge valve is fitted, it shall be capable of being made secure in the closed position and the whole discharge system shall be suitably protected from damage. Valves having lever closures shall be able to be secured against unintended opening and the open or closed position shall be readily apparent.

##### 6.9.2.3 Code for designating types of bulk container

The following table indicates the codes to be used for designating types of bulk containers:

| Types of bulk container | Code |
|-------------------------|------|
| Sheeted bulk container  | BK1  |
| Closed bulk container   | BK2  |
| Flexible bulk container | BK3  |

6.9.2.4 In order to take account of progress in science and technology, the use of alternative arrangements which offer at least equivalent safety as provided by the provisions of this chapter may be considered by the competent authority.

#### 6.9.3 Provisions for the design, construction, inspection and testing of freight containers used as BK1 or BK2 bulk containers

##### 6.9.3.1 Design and construction provisions

6.9.3.1.1 The general design and construction provisions in this section are deemed to be met if the bulk container complies with the requirements of ISO 1496-4:1991, *Series 1 freight containers – Specification and testing – Part 4: Non-pressurized containers for dry bulk*, and the container is siftproof.

6.9.3.1.2 Freight containers designed and tested in accordance with ISO 1496-1:1990, *Series 1 freight containers – Specification and testing – Part 1: General cargo containers for general purposes*, shall be equipped with

**Part 6 – Construction and testing of packagings, IBCs, etc.**

operational equipment which is, including its connection to the freight container, designed to strengthen the end walls and to improve the longitudinal restraint as necessary to comply with the test requirements of ISO 1496-4:1991, as relevant.

**6.9.3.1.3** Bulk containers shall be siftproof. Where a liner is used to make the container siftproof, it shall be made of a suitable material. The strength of the material used for, and the construction of, the liner shall be appropriate to the capacity of the container and its intended use. Joins and closures of the liner shall withstand pressures and impacts liable to occur under normal conditions of handling and transport. For ventilated bulk containers, any liner shall not impair the operation of ventilating devices.

**6.9.3.1.4** The operational equipment of bulk containers designed to be emptied by tilting shall be capable of withstanding the total filling mass in the tilted orientation.

**6.9.3.1.5** Any movable roof or side or end wall or roof section shall be fitted with locking devices with securing devices designed to show the locked state to an observer at ground level.

**6.9.3.2 Service equipment**

**6.9.3.2.1** Filling and discharge devices shall be so constructed and arranged as to be protected against the risk of being wrenched off or damaged during transport and handling. The filling and discharge devices shall be capable of being secured against unintended opening. The open and closed position and direction of closure shall be clearly indicated.

**6.9.3.2.2** Seals of openings shall be so arranged as to avoid any damage by the operation, filling and emptying of the bulk container.

**6.9.3.2.3** Where ventilation is required, bulk containers shall be equipped with means of air exchange, either by natural convection, e.g. by openings, or active elements, e.g. fans. The ventilation shall be designed to prevent negative pressures in the container at all times. Ventilating elements of bulk containers for the transport of flammable substances or substances emitting flammable gases or vapours shall be designed so as not to be a source of ignition.

**6.9.3.3 Inspection and testing**

**6.9.3.3.1** Freight containers used, maintained and qualified as bulk containers in accordance with the requirements of this section shall be tested and approved in accordance with the *International Convention for Safe Containers, 1972* (CSC Convention), as amended.

**6.9.3.3.2** Freight containers used and qualified as bulk containers shall be inspected periodically according to that Convention.

**6.9.3.4 Marking**

**6.9.3.4.1** Freight containers used as bulk containers shall be marked with a Safety Approval Plate in accordance with the *International Convention for Safe Containers, 1972* (CSC Convention).

**6.9.4 Provisions for the design, construction and approval of BK1 or BK2 bulk containers other than freight containers**

**6.9.4.1** Bulk containers covered in this section include skips, offshore bulk containers, bulk bins, swap bodies, trough-shaped containers, roller containers, and load compartments of vehicles.

**6.9.4.2** These bulk containers shall be designed and constructed so as to be strong enough to withstand the shocks and loadings normally encountered during transport, including, as applicable, transshipment between modes of transport.

**6.9.4.3** Load compartments of vehicles shall comply with the requirements of, and be acceptable to, the competent authority responsible for land transport of the dangerous goods to be transported in bulk.

**6.9.4.4** These bulk containers shall be approved by the competent authority and the approval shall include the code for designating types of bulk containers in accordance with 6.9.2.3 and the provisions for inspection and testing, as appropriate.

**6.9.4.5** Where it is necessary to use a liner in order to retain the dangerous goods, it shall meet the provisions of 6.9.3.1.3.

6.9.4.6 The following statement shall be shown on the transport document:

“Bulk container BK(x) approved by the competent authority of ...”.

**Note:** “(x)” shall be replaced with “1” or “2”, as appropriate.

## 6.9.5 Requirements for the design, construction, inspection and testing of flexible bulk containers BK3

### 6.9.5.1 Design and construction requirements

6.9.5.1.1 Flexible bulk containers shall be sift-proof.

6.9.5.1.2 Flexible bulk containers shall be completely closed to prevent the release of contents.

6.9.5.1.3 Flexible bulk containers shall be waterproof.

6.9.5.1.4 Parts of the flexible bulk container which are in direct contact with dangerous goods:

- (a) shall not be affected or significantly weakened by those dangerous goods;
- (b) shall not cause a dangerous effect, e.g. catalysing a reaction or reacting with the dangerous goods; and
- (c) shall not allow permeation of the dangerous goods that could constitute a danger under normal conditions of transport.

### 6.9.5.2 Service equipment and handling devices

6.9.5.2.1 Filling and discharge devices shall be so constructed as to be protected against damage during transport and handling. The filling and discharge devices shall be capable of being secured against unintended opening.

6.9.5.2.2 Slings of the flexible bulk container, if fitted, shall withstand pressure and dynamic forces which can appear in normal conditions of handling and transport.

6.9.5.2.3 The handling devices shall be strong enough to withstand repeated use.

### 6.9.5.3 Inspection and testing

6.9.5.3.1 Each flexible bulk container design type shall successfully pass the tests prescribed in this chapter before being used.

6.9.5.3.2 Tests shall also be repeated after each modification of design type which alters the design, material or manner of construction of a flexible bulk container.

6.9.5.3.3 Tests shall be carried out on flexible bulk containers prepared as for transport. Flexible bulk containers shall be filled to the maximum mass at which they may be used and the contents shall be evenly distributed. The substances to be transported in the flexible bulk container may be replaced by other substances except where this would invalidate the results of the tests. When another substance is used it shall have the same physical characteristics (mass, grain size, etc.) as the substance to be transported. It is permissible to use additives, such as bags of lead shot, to achieve the requisite total mass of the flexible bulk container, so long as they are placed so that the test results are not affected.

6.9.5.3.4 Flexible bulk containers shall be manufactured and tested under a quality assurance programme which satisfies the competent authority, in order to ensure that each manufactured flexible bulk container meets the requirements of this chapter.

#### 6.9.5.3.5 *Drop test*

##### 6.9.5.3.5.1 *Applicability*

For all types of flexible bulk containers, as a design type test.

##### 6.9.5.3.5.2 *Preparation for testing*

The flexible bulk container shall be filled to its maximum permissible gross mass.

6.9.5.3.5.3 The flexible bulk container shall be dropped onto a target surface that is non-resilient and horizontal. The target surface shall be:

- (a) integral and massive enough to be immovable;
- (b) flat with a surface kept free from local defects capable of influencing the test results;
- (c) rigid enough to be non-deformable under test conditions and not liable to become damaged by the tests; and

*Part 6 – Construction and testing of packagings, IBCs, etc.*

(d) sufficiently large to ensure that the test flexible bulk container falls entirely upon the surface.

Following the drop, the flexible bulk container shall be restored to the upright position for observation.

6.9.5.3.5.4 Drop height shall be:

Packing group III: 0.8 m

6.9.5.3.5.5 Criteria for passing the test:

- (a) there shall be no loss of contents. A slight discharge, e.g. from closures or stitch holes, upon impact shall not be considered to be a failure of the flexible bulk container provided that no further leakage occurs after the container has been restored to the upright position;
- (b) there shall be no damage which renders the flexible bulk container unsafe to be transported for salvage or for disposal.

6.9.5.3.6 **Top lift test**

6.9.5.3.6.1 *Applicability*

For all types of flexible bulk containers as a design type test.

6.9.5.3.6.2 *Preparation for testing*

Flexible bulk containers shall be filled to six times the maximum net mass, the load being evenly distributed.

6.9.5.3.6.3 A flexible bulk container shall be lifted in the manner for which it is designed until clear of the floor and maintained in that position for a period of five minutes.

6.9.5.3.6.4 Criteria for passing the test: there shall be no damage to the flexible bulk container or its lifting devices which renders the flexible bulk container unsafe for transport or handling, and no loss of contents.

6.9.5.3.7 **Topple test**

6.9.5.3.7.1 *Applicability*

For all types of flexible bulk containers as a design type test.

6.9.5.3.7.2 *Preparation for testing*

The flexible bulk container shall be filled to its maximum permissible gross mass.

6.9.5.3.7.3 A flexible bulk container shall be toppled onto any part of its top by lifting the side furthest from the drop edge upon a target surface that is non-resilient and horizontal. The target surface shall be:

- (a) integral and massive enough to be immovable;
- (b) flat with a surface kept free from local defects capable of influencing the test results;
- (c) rigid enough to be non-deformable under test conditions and not liable to become damaged by the tests; and
- (d) sufficiently large to ensure that the test flexible bulk container falls entirely upon the surface.

6.9.5.3.7.4 For all flexible bulk containers, the topple height is specified as follows:

Packing group III: 0.8 m

6.9.5.3.7.5 Criterion for passing the test: there shall be no loss of contents. A slight discharge, e.g. from closures or stitch holes, upon impact shall not be considered to be a failure of the flexible bulk container provided that no further leakage occurs.

6.9.5.3.8 **Righting test**

6.9.5.3.8.1 *Applicability*

For all types of flexible bulk containers designed to be lifted from the top or side, as a design type test.

6.9.5.3.8.2 *Preparation for testing*

The flexible bulk container shall be filled to not less than 95% of its capacity and to its maximum permissible gross mass.

6.9.5.3.8.3 The flexible bulk container, lying on its side, shall be lifted at a speed of at least 0.1 m/s to an upright position, clear of the floor, by no more than half of the lifting devices.

6.9.5.3.8.4 Criterion for passing the test: there shall be no damage to the flexible bulk container or its lifting devices which renders the flexible bulk container unsafe for transport or handling.

**6.9.5.3.9 Tear test****6.9.5.3.9.1 Applicability**

For all types of flexible bulk containers as a design type test.

**6.9.5.3.9.2 Preparation for testing**

The flexible bulk container shall be filled to its maximum permissible gross mass.

**6.9.5.3.9.3** With the flexible bulk container placed on the ground, a 300 mm cut shall be made, completely penetrating all layers of the flexible bulk container on a wall of a wide face. The cut shall be made at a 45° angle to the principal axis of the flexible bulk container, halfway between the bottom surface and the top level of the contents. The flexible bulk container shall then be subjected to a uniformly distributed superimposed load equivalent to twice the maximum gross mass. The load must be applied for at least fifteen minutes. A flexible bulk container which is designed to be lifted from the top or the side shall, after removal of the superimposed load, be lifted clear of the floor and maintained in that position for a period of fifteen minutes.

**6.9.5.3.9.4** Criterion for passing the test: the cut shall not propagate more than 25% of its original length.

**6.9.5.3.10 Stacking test****6.9.5.3.10.1 Applicability**

For all types of flexible bulk containers as a design type test.

**6.9.5.3.10.2 Preparation for testing**

The flexible bulk container shall be filled to its maximum permissible gross mass.

**6.9.5.3.10.3** The flexible bulk container shall be subjected to a force applied to its top surface that is four times the design load-carrying capacity for 24 h.

**6.9.5.3.10.4** Criterion for passing the test: there shall be no loss of contents during the test or after removal of the load.

**6.9.5.4 Test report**

**6.9.5.4.1** A test report containing at least the following particulars shall be drawn up and shall be available to the users of the flexible bulk container:

- .1 name and address of the test facility;
- .2 name and address of applicant (where appropriate);
- .3 unique test report identification;
- .4 date of the test report;
- .5 manufacturer of the flexible bulk container;
- .6 description of the flexible bulk container design type (e.g. dimensions, materials, closures, thickness, etc.) and/or photograph(s);
- .7 maximum capacity/maximum permissible gross mass;
- .8 characteristics of test contents, e.g. particle size for solids;
- .9 test descriptions and results;
- .10 the test report shall be signed with the name and status of the signatory.

**6.9.5.4.2** The test report shall contain statements that the flexible bulk container prepared as for transport was tested in accordance with the appropriate provisions of this chapter and that the use of other containment methods or components may render it invalid. A copy of the test report shall be available to the competent authority.

**6.9.5.5 Marking**

**6.9.5.5.1** Each flexible bulk container manufactured and intended for use according to these provisions shall bear marks that are durable, legible and placed in a location so as to be readily visible. Letters, numerals and symbols shall be at least 24 mm high and shall show:

- (a) the United Nations packaging symbol:



This symbol shall not be used for any purpose other than certifying that a packaging, a flexible bulk container, a portable tank or a MEGC complies with the relevant requirements in chapters 6.1, 6.2, 6.3, 6.5, 6.6, 6.7 or 6.9;

*Part 6 – Construction and testing of packagings, IBCs, etc.*

---

- (b) the code BK3;
- (c) a capital letter designating the packing group(s) for which the design type has been approved:  
Z for packing group III only;
- (d) the month and year (last two digits) of manufacture;
- (e) the character(s) identifying the country authorizing the allocation of the mark; as indicated by the distinguishing signs used on vehicles in international road traffic\*;
- (f) the name or symbol of the manufacturer and other identification of the flexible bulk container as specified by the competent authority;
- (g) the stacking test load in kg;
- (h) the maximum permissible gross mass in kg.

Marks shall be applied in the sequence shown in (a) to (h); each mark, required in these subparagraphs, shall be clearly separated, e.g. by a slash or space and presented in a way that ensures that all of the parts of the mark are easily identified.

**6.9.5.5.2** Example of marking



BK3/Z/11 09  
RUS/NTT/MK-14-10  
56000/14000

---

\* Distinguishing sign of the State of registration used on motor vehicles and trailers in international road traffic, e.g. in accordance with the Geneva Convention on Road Traffic of 1949 or the Vienna Convention on Road Traffic of 1968.

## Chapter 6.10

### *Provisions for the design, construction, inspection and testing of portable tanks with shells made of fibre-reinforced plastics (FRP) materials*

#### 6.10.1 Application and general requirements

- 6.10.1.1 The requirements of section 6.10.2 apply to portable tanks with an FRP shell intended for the transport of dangerous goods of classes or divisions 1, 3, 5.1, 6.1, 6.2, 8 and 9 by all modes of transport. In addition to the requirements of this chapter, unless otherwise specified, the applicable requirements of the *International Convention for Safe Containers, 1972* (CSC Convention), as amended, shall be fulfilled by any multimodal portable tank with FRP shell which meets the definition of a “container” within the terms of that Convention.
- 6.10.1.2 The provisions of this chapter do not apply to offshore portable tanks.
- 6.10.1.3 The provisions of chapter 4.2 and section 6.7.2 apply to FRP portable tank shells except for those concerning the use of metal materials for the construction of a portable tank shell and additional provisions stated in this chapter.
- 6.10.1.4 In recognition of scientific and technological advances, the technical requirements of this chapter may be varied by alternative arrangements. These alternative arrangements shall offer a level of safety not less than that given by the provisions of this chapter with respect to compatibility with substances transported and the ability of the FRP portable tank to withstand impact, loading and fire conditions. For international transport, alternative arrangement FRP portable tanks shall be approved by the applicable competent authorities.

#### 6.10.2 Provisions for the design, construction, inspection and testing of FRP portable tanks

##### 6.10.2.1 Definitions

For the purposes of this section, the definitions of 6.7.2.1 apply except for definitions related to metal materials (“Fine grain steel”, “Mild steel” and “Reference steel”) for the construction of the shell of a portable tank.

Additionally, the following definitions apply to portable tanks with an FRP shell:

*External layer* means the part of the shell which is directly exposed to the atmosphere.

*Fibre-reinforced plastic (FRP)* means material consisting of fibrous and/or particulate reinforcement contained within a thermoset or thermoplastic polymer (matrix).

*Filament winding* means a process for constructing FRP structures in which continuous reinforcements (filament, tape, or other), either previously impregnated with a matrix material or impregnated during winding, are placed over a rotating mandrel. Generally, the shape is a surface of revolution and may include ends (heads).

*FRP shell* means a closed part of cylindrical shape with an interior volume intended for transport of chemical substances.

*FRP tank* means a portable tank constructed with an FRP shell and ends (heads), service equipment, safety relief devices and other installed equipment.

*Glass transition temperature (T<sub>g</sub>)* means a characteristic value of the temperature range over which the glass transition takes place.

*Hand layup* means a process for moulding reinforced plastics in which reinforcement and resin are placed on a mould.

*Liner* means a layer on the inner surface of an FRP shell preventing contact with the dangerous goods being transported.



**Part 6 – Construction and testing of packagings, IBCs, etc.**

*Mat* means a fibre reinforcement made of random, chopped or twisted fibres bonded together as sheets of various length and thickness.

*Parallel shell sample* means an FRP specimen, which must be representative of the shell, constructed in parallel to the shell construction if it is not possible to use cut-outs from the shell itself. The parallel shell sample may be flat or curved.

*Representative sample* means a sample cut out from the shell.

*Resin infusion* means an FRP construction method by which dry reinforcement is placed into a matched mould, single-sided mould with vacuum bag, or otherwise, and liquid resin is supplied to the part through the use of external applied pressure at the inlet and/or application of full or partial vacuum pressure at the vent.

*Structural layer* means FRP layers of a shell required to sustain the design loads.

*Veil* means a thin mat with high absorbency used in FRP product plies where polymeric matrix surplus fraction content is required (surface evenness, chemical resistance, leakage-proof, etc.).

**6.10.2.2 General design and construction provisions**

**6.10.2.2.1** The provisions of 6.7.1 and 6.7.2.2 apply to FRP portable tanks. For areas of the shell that are made from FRP, the following provisions of chapter 6.7 are exempt: 6.7.2.2.1, 6.7.2.2.9.1, 6.7.2.2.13 and 6.7.2.2.14. Shells shall be designed and constructed in accordance with the requirements of a pressure vessel code, applicable to FRP materials, recognized by the competent authority.

In addition, the following requirements apply.

**6.10.2.2.2 Manufacturer's quality system**

**6.10.2.2.2.1** The quality system shall contain all the elements, requirements and provisions adopted by the manufacturer. It shall be documented in a systematic and orderly manner in the form of written policies, procedures and instructions.

**6.10.2.2.2.2** The contents shall in particular include adequate descriptions of:

- .1 the organizational structure and responsibilities of personnel with regard to design and product quality;
- .2 the design control and design verification techniques, processes and procedures that will be used when designing the portable tanks;
- .3 the relevant manufacturing, quality control, quality assurance and process operation instructions that will be used;
- .4 quality records, such as inspection reports, test data and calibration data;
- .5 management reviews to ensure the effective operation of the quality system arising from the audits in accordance with 6.10.2.2.2.4;
- .6 the process describing how customer requirements are met;
- .7 the process for control of documents and their revision;
- .8 the means for control of non-conforming portable tanks, purchased components, in-process and final materials; and
- .9 the training programmes and qualification procedures for relevant personnel.

**6.10.2.2.2.3** Under the quality system, the following minimum requirements shall be met for each FRP portable tank manufactured:

- .1 use of an inspection and test plan (ITP);
- .2 visual inspections;
- .3 verification of fibre orientation and mass fraction by means of a documented control process;
- .4 verification of fibre and resin quality and characteristics by means of certificates or other documentation;
- .5 verification of liner quality and characteristics by means of certificates or other documentation;
- .6 verification of whichever is applicable of formed thermoplastic resin characteristic or degree of cure of thermoset resin, by direct or indirect means (e.g. Barcol test or differential scanning calorimetry) to be determined in accordance with 6.10.2.7.1.2.8, or by creep testing of a representative sample or parallel shell specimen in accordance with 6.10.2.7.1.2.5 for a period of 100 hours;
- .7 documentation of whichever is applicable of thermoplastic resin forming processes or thermoset resin cure and post-cure processes; and
- .8 retention and archiving of shell samples for future inspection and shell verification (e.g. from manhole cut-out) for a period of five years.

#### 6.10.2.2.2.4 *Audit of the quality system*

The quality system shall be initially assessed to determine whether it meets the provisions in 6.10.2.2.2.1 to 6.10.2.2.2.3 to the satisfaction of the competent authority.

The manufacturer shall be notified of the results of the audit. The notification shall contain the conclusions of the audit and any corrective actions required.

Periodic audits shall be carried out, to the satisfaction of the competent authority, to ensure that the manufacturer maintains and applies the quality system. Reports of the periodic audits shall be provided to the manufacturer.

#### 6.10.2.2.2.5 *Maintenance of the quality system*

The manufacturer shall maintain the quality system as approved in order that it remains adequate and efficient.

The manufacturer shall notify the competent authority that approved the quality system of any intended changes. The proposed changes shall be evaluated to determine whether the amended quality system will still satisfy the provisions in 6.10.2.2.2.1 to 6.10.2.2.2.3.

#### 6.10.2.2.3 *FRP Shells*

6.10.2.2.3.1 FRP shells shall have a secure connection with structural elements of the portable tank frame. FRP shell supports and attachments to the frame shall cause no local stress concentrations exceeding the design allowables of the shell structure in accordance with the provisions stated in this chapter for all operating and test conditions.

6.10.2.2.3.2 Shells shall be made of suitable materials, capable of operating within a minimum design temperature range of  $-40^{\circ}\text{C}$  to  $+50^{\circ}\text{C}$ , unless temperature ranges are specified for specific more severe climatic or operating conditions (e.g. heating elements), by the competent authority of the country where the transport operation is being performed.

6.10.2.2.3.3 If a heating system is installed, it shall comply with 6.7.2.5.12 to 6.7.2.5.15 and with the following provisions:

- .1 the maximum operating temperature of the heating elements integrated or connected to the shell shall not exceed the maximum design temperature of the tank;
- .2 the heating elements shall be designed, controlled and utilized so that the temperature of the carried substance cannot exceed the maximum design temperature of the tank or a value at which the internal pressure exceeds MAWP; and
- .3 structures of the tank and its heating elements shall allow examination of the shell with respect to possible effects of overheating.

6.10.2.2.3.4 Shells shall consist of the following elements:

- liner;
- structural layer; and
- external layer.

**Note:** The elements may be combined if all applicable functional criteria are met.

6.10.2.2.3.5 The liner is the inner element of the shell designed as the primary barrier to provide for the long-term chemical resistance in relation to the substances to be carried, to prevent any dangerous reaction with the contents or the formation of dangerous compounds and any substantial weakening of the structural layer owing to the diffusion of products through the liner. Chemical compatibility shall be verified in accordance with 6.10.2.7.1.3.

The liner may be an FRP liner or a thermoplastic liner.

6.10.2.2.3.6 FRP liners shall consist of the following two components:

- .1 Surface layer (“gel-coat”): adequate resin rich surface layer, reinforced with a veil, compatible with the resin and contents. This layer shall have a maximum fibre mass content of 30% and have a minimum thickness of 0.25 mm and a maximum thickness of 0.60 mm.
- .2 Strengthening layer(s): layer or several layers with a minimum thickness of 2 mm, containing a minimum of  $900\text{ g/m}^2$  of glass mat or chopped fibres with a mass content in glass of not less than 30% unless equivalent safety is demonstrated for a lower glass content.

6.10.2.2.3.7 If the liner consists of thermoplastic sheets, they shall be welded together in the required shape, using a qualified welding procedure and personnel. Welded liners shall have a layer of electrically conductive media placed against the non-liquid contact surface of the welds to facilitate spark testing. Durable bonding between liners and the structural layer shall be achieved by the use of an appropriate method.

**Part 6 – Construction and testing of packagings, IBCs, etc.**

---

**6.10.2.2.3.8** The structural layer shall be designed to withstand the design loads according to 6.7.2.2.12, 6.10.2.2.3.1, 6.10.2.3.2, 6.10.2.3.4 and 6.10.2.3.6.

**6.10.2.2.3.9** The external layer of resin or paint shall provide adequate protection of the structural layers of the tank from environmental and service exposure, including UV radiation and salt fog, and occasional splash exposure to cargoes.

**6.10.2.2.3.10 Resins**

The processing of the resin mixture shall be carried out in compliance with the recommendations of the supplier. These resins can be:

- unsaturated polyester resins;
- vinyl ester resins;
- epoxy resins;
- phenolic resins; and
- thermoplastic resins.

The resin heat distortion temperature (HDT), determined in accordance with 6.10.2.7.1.1 shall be at least 20°C higher than the maximum design temperature of the shell as defined in 6.10.2.2.3.2, but shall in any case not be lower than 70°C.

**6.10.2.2.3.11 Reinforcement material**

The reinforcement material of the structural layers shall be selected such that they meet the requirements of the structural layer.

For the liner glass fibres of at a minimum type C or ECR according to ISO 2078:1993 + Amd 1:2015 shall be used. Thermoplastic veils may only be used for the liner when their compatibility with the intended contents has been demonstrated.

**6.10.2.2.3.12 Additives**

Additives necessary for the treatment of the resin, such as catalysts, accelerators, hardeners and thixotropic substances as well as materials used to improve the tank, such as fillers, colours, pigments, etc. shall not cause weakening of the material, taking into account lifetime and temperature expectancy of the design.

**6.10.2.2.3.13** FRP shells, their attachments and their service and structural equipment shall be designed to withstand the loads mentioned in 6.7.2.2.12, 6.10.2.2.3, 6.10.2.3.2, 6.10.2.3.4 and 6.10.2.3.6 without loss of contents (other than quantities of gas escaping through any degassing vents) during the design lifetime.

**6.10.2.2.3.14 Special provisions for the carriage of substances with a flashpoint of not more than 60°C**

**6.10.2.2.3.14.1** FRP tanks used for the carriage of flammable liquids with a flashpoint of not more than 60°C shall be constructed to ensure the elimination of static electricity from the various component parts to avoid the accumulation of dangerous charges.

**6.10.2.2.3.14.2** The electrical surface resistance of the inside and outside of the shell as established by measurements shall not be higher than  $10^9 \Omega$ . This may be achieved by the use of additives in the resin or interlaminar conducting sheets, such as metal or carbon network.

**6.10.2.2.3.14.3** The discharge resistance to earth as established by measurements shall not be higher than  $10^7 \Omega$ .

**6.10.2.2.3.14.4** All components of the shell shall be electrically connected to each other and to the metal parts of the service and structural equipment of the tank and, when applicable, to the vehicle. The electrical resistance between components and equipment in contact with each other shall not exceed 10  $\Omega$ .

**6.10.2.2.3.14.5** The electrical surface-resistance and discharge resistance shall be measured initially on each manufactured tank or a specimen of the shell in accordance with the procedure recognized by the competent authority. In the event of damage to the shell, requiring repair, the electrical resistance shall be re-measured.

**6.10.2.2.3.15** The tank shall be designed to withstand, without significant leakage, the effects of a full engulfment in fire for 30 minutes as specified by the test requirements in 6.10.2.7.1.5. Testing may be waived with the agreement of the competent authority, where sufficient proof can be provided by tests with comparable tank designs.

**6.10.2.2.3.16 Construction process for FRP shells**

**6.10.2.2.3.16.1** Filament winding, hand layup, resin infusion or other appropriate composite production processes shall be used for construction of FRP shells.

## Chapter 6.10 – Provisions for portable tanks with shells made of FRP materials

6.10.2.2.3.16.2 The weight of the fibre reinforcement shall conform to that set forth in the procedure specification with a tolerance of +10% and –0%. One or more of the fibre types specified in 6.10.2.2.3.11 and in the procedure specification shall be used for reinforcement of shells.

6.10.2.2.3.16.3 The resin system shall be one of the resin systems specified in 6.10.2.2.3.10. No filler, pigment, or dye additions shall be used which will interfere with the natural colour of the resin except as permitted by the procedure specification.

### 6.10.2.3 Design criteria

6.10.2.3.1 FRP shells shall be of a design capable of being stress-analysed mathematically or experimentally by resistance strain gauges, or by other methods approved by the competent authority.

6.10.2.3.2 FRP shells shall be designed and constructed to withstand the test pressure. Specific provisions are laid down for certain substances in the applicable portable tank instruction indicated in column 13 of the Dangerous Goods List and described in 4.2.5, or by a portable tank special provision indicated in column 14 of the Dangerous Goods List and described in 4.2.5.3. The minimum wall thickness of the FRP shell shall not be less than that specified in 6.10.2.4.

6.10.2.3.3 At the specified test pressure the maximum tensile relative deformation measured in mm/mm in the shell shall not result in the formation of microcracks, and therefore not be greater than the first measured point of elongation based fracture or damage of the resin, measured during tensile tests prescribed under 6.10.2.7.1.2.3.

6.10.2.3.4 For internal test pressure, external design pressure specified in 6.7.2.2.10, static loads specified in 6.7.2.2.12 and static gravity loads caused by the contents with the maximum density specified for the design and at maximum filling degree, failure criteria (FC) in the longitudinal direction, circumferential direction, and any other in-plane direction of the composite layup shall not exceed the following value:

$$FC \leq \frac{1}{K}$$

where:

$$K = K_0 \times K_1 \times K_2 \times K_3 \times K_4 \times K_5$$

where:

$K$  shall have a minimum value of 4.

$K_0$  is a strength factor. For the general design the value for  $K_0$  shall be equal to or more than 1.5. The value of  $K_0$  shall be multiplied by a factor of two, unless the shell is provided with protection against damage consisting of a complete metal skeleton including longitudinal and transverse structural members.

$K_1$  is a factor related to the deterioration in the material properties due to creep and ageing. It shall be determined by the formula:

$$K_1 = \frac{1}{\alpha\beta}$$

where “ $\alpha$ ” is the creep factor and “ $\beta$ ” is the ageing factor determined in accordance with 6.10.2.7.1.2.5 and .6, respectively. When used in calculation, factors  $\alpha$  and  $\beta$  shall be between 0 and 1.

Alternatively, a conservative value of  $K_1 = 2$  may be applied for the purpose of undertaking the numerical validation exercise in 6.10.2.3.4 (this does not remove the need to perform testing to determine  $\alpha$  and  $\beta$ ).

$K_2$  is a factor related to the service temperature and the thermal properties of the resin, determined by the following equation, with a minimum value of 1:  $K_2 = 1.25 - 0.0125(\text{HDT} - 70)$  where HDT is the heat distortion temperature of the resin, in °C.

$K_3$  is a factor related to the fatigue of the material; the value of  $K_3 = 1.75$  shall be used unless otherwise agreed with the competent authority. For the dynamic design as outlined in 6.7.2.2.12 the value of  $K_3 = 1.1$  shall be used.

$K_4$  is a factor related to resin curing and has the following values:

1.0 where curing is carried out in accordance with an approved and documented process, and the quality system described under 6.10.2.2.2 includes verification of degree of cure for each FRP portable tank using a direct measurement approach, such as differential scanning calorimetry (DSC) determined via ISO 11357-2:2016, as per 6.10.2.7.1.2.8.1.

1.1 where thermoplastic resin forming or thermoset resin curing is carried out in accordance with an approved and documented process, and the quality system described under 6.10.2.2.2 includes verification of whichever is applicable, formed thermoplastic resin characteristics or degree of cure of thermoset resin, for each FRP portable tank using an indirect measurement approach as per 6.10.2.7.1.2.8, such as Barcol testing via

Part 6 – Construction and testing of packagings, IBCs, etc.

ASTM D2583:2013-03 or EN 59:2016, HDT via ISO 75-1:2013, thermo-mechanical analysis (TMA) via ISO 11359-1:2014, or dynamic thermo-mechanical analysis (DMA) via ISO 6721-11:2019.

1.5 in other cases.

$K_5$  is a factor related to the portable tank instruction in 4.2.5.2.6:

1.0 for T1 to T19.

1.33 for T20.

1.67 for T21 to T22.

A design validation exercise using numerical analysis and a suitable composite failure criterion is to be undertaken to verify that the stresses in the plies in the shell are below the allowables. Suitable composite failure criteria include, but are not limited to, Tsai-Wu, Tsai-Hill, Hashin, Yamada-Sun, Strain Invariant Failure Theory, Maximum Strain or Maximum Stress. Other relations for the strength criteria are allowed upon agreement with the competent authority. The method and results of this design validation exercise are to be submitted to the competent authority.

The allowables are to be determined using experiments to derive parameters required by the chosen failure criteria combined with factor of safety  $K$ , the strength values measured as per 6.10.2.7.1.2.3, and the maximum elongation strain criteria prescribed in 6.10.2.3.5. The analysis of joints is to be undertaken in accordance with the allowables determined in 6.10.2.3.7 and the strength values measured as per 6.10.2.7.1.2.7. Buckling is to be considered in accordance with 6.10.2.3.6. Design of openings and metallic inclusions is to be considered in accordance with 6.10.2.3.8.

6.10.2.3.5 At any of the stresses as defined in 6.7.2.2.12 and 6.10.2.3.4, the resulting elongation in any direction shall not exceed the value indicated in the following table or one tenth of the elongation at fracture of the resin determined by ISO 527 2:2012, whichever is lower.

Examples of known limits are presented in the table below.

| Type of resin                     | Maximum strain in tension (%) |
|-----------------------------------|-------------------------------|
| Unsaturated polyester or phenolic | 0.2                           |
| Vinylester                        | 0.25                          |
| Epoxy                             | 0.3                           |
| Thermoplastic                     | See 6.10.2.3.3                |

6.10.2.3.6 For the external design pressure, the minimum safety factor for linear buckling analysis of the shell shall be as defined in the applicable pressure vessel code but not less than three.

6.10.2.3.7 The adhesive bondlines and/or overlay laminates used in the joints, including the end joints, connection between the equipment and shell, the joints of the surge plates and the partitions with the shell shall be capable of withstanding the loads of 6.7.2.2.12, 6.10.2.2.3.1, 6.10.2.3.2, 6.10.2.3.4 and 6.10.2.3.6. In order to avoid concentrations of stresses in the overlay lamination, the applied taper shall not be steeper than 1:6. The shear strength between the overlay laminate and the tank components to which it is bonded shall not be less than:

$$\tau = y \frac{Q}{l} \leq \frac{\tau_R}{K}$$

where:

$\tau_R$  is the interlaminar shear strength according to ISO 14130:1997 and Cor 1:2003;

$Q$  is the load per unit width of the interconnection;

$K$  is the safety factor determined as per 6.10.2.3.4;

$l$  is the length of the overlay laminate;

$y$  is the notch factor relating average joint stress to peak joint stress at failure initiation location.

Other calculation methods for the joints are allowed following approval with the competent authority.

6.10.2.3.8 Metallic flanges and their closures are permitted to be used in FRP shells, under design provisions of 6.7.2. Openings in the FRP shell shall be reinforced to provide at least the same safety factors against the static and dynamic stresses as specified in 6.7.2.2.12, 6.10.2.3.2, 6.10.2.3.4 and 6.10.2.3.6 as that for the shell itself. The number of openings shall be minimized. The axis ratio of oval-shaped openings shall be not more than 2.

If metallic flanges or componentry are integrated into the FRP shell using bonding, then the characterization method stated in 6.10.2.3.7 shall apply to the joint between the metal and FRP. If the metallic flanges or componentry are fixed in an alternative fashion, e.g. threaded fastener connections, then the appropriate provisions of the relevant pressure vessel standard shall apply.



## Chapter 6.10 – Provisions for portable tanks with shells made of FRP materials

6.10.2.3.9 Check calculations of the strength of the shell shall be performed by finite element method simulating the shell layouts, joints within FRP shell, joints between the FRP shell and the container frame, and openings. Treatment of singularities shall be undertaken using an appropriate method according to the applicable pressure vessel code.

#### 6.10.2.4 Minimum wall thickness of the shell

6.10.2.4.1 Minimum thickness of the FRP shell shall be confirmed by check calculations of the strength of the shell considering strength provisions given in 6.10.2.3.4.

6.10.2.4.2 Minimum thickness of the FRP shell structural layers shall be determined in accordance with 6.10.2.3.4; however, in any case the minimum thickness of the structural layers shall be at least 3 mm.

#### 6.10.2.5 Equipment components for portable tanks with FRP shell

Service equipment, bottom openings, pressure relief devices, gauging devices, supports, frameworks, lifting and tie-down attachments of portable tanks shall meet the provisions of 6.7.2.5 to 6.7.2.17. If any other metallic features are required to be integrated into the FRP shell, then the provisions of 6.10.2.3.8 shall apply.

#### 6.10.2.6 Design approval

6.10.2.6.1 Design approval of FRP portable tanks shall be as per 6.7.2.18 provisions. The following additional provisions apply to FRP portable tanks.

6.10.2.6.2 The prototype test report for the purpose of the design approval shall additionally include the following:

- .1 results of the material tests used for FRP shell fabrication in accordance with 6.10.2.7.1 provisions;
- .2 results of the ball drop test in accordance with the provisions of 6.10.2.7.1.4; and
- .3 results of the fire resistance test in accordance with the provisions of 6.10.2.7.1.5.

6.10.2.6.3 A service life inspection programme shall be established, which shall be a part of the operation manual, to monitor the condition of the tank at periodic inspections. The inspection programme shall focus on the critical stress locations identified in the design analysis performed under 6.10.2.3.4. The inspection method shall take into account the potential damage mode at the critical stress location (e.g. tensile stress or interlaminar stress). The inspection shall be a combination of visual and non-destructive testing (e.g. acoustic emissions, ultrasonic evaluation, thermographic). For heating elements, the service life inspection programme shall allow an examination of the shell or its representative locations to take into account the effects of overheating.

6.10.2.6.4 A representative prototype tank shall be subjected to tests as specified below. For this purpose, service equipment may be replaced by other items if necessary.

6.10.2.6.4.1 The prototype shall be inspected for compliance with the design type specification. This shall include an internal and external inspection and measurement of the main dimensions.

6.10.2.6.4.2 The prototype, equipped with strain gauges at all locations of high strain, as identified by the design validation exercise in accordance with 6.10.2.3.4, shall be subjected to the following loads and the strain shall be recorded:

- .1 Filled with water to the maximum filling degree. The measuring results shall be used to calibrate the design calculations according to 6.10.2.3.4.
- .2 Filled with water to the maximum filling degree and subjected to static loads in all three directions mounted by the base corner castings without additional mass applied external to the shell. For comparison with the design calculation according to 6.10.2.3.4 the strains recorded shall be extrapolated in relation to the quotient of the accelerations required in 6.7.2.2.12 and measured.
- .3 Filled with water and subjected to the specified test pressure. Under this load, the shell shall exhibit no visual damage or leakage. The stress corresponding to the measured strain level shall not exceed the minimum factor of safety calculated in 6.10.2.3.4 under any of these loading conditions.

#### 6.10.2.7 Additional provisions applicable to FRP portable tanks

##### 6.10.2.7.1 Material testing

##### 6.10.2.7.1.1 Resins

Resin tensile elongation shall be determined in accordance with ISO 527-2:2012. The heat distortion temperature (HDT) of the resin shall be determined in accordance with ISO 75-1:2013.



**Part 6 – Construction and testing of packagings, IBCs, etc.****6.10.2.7.1.2 Shell samples**

Prior to testing, all coatings shall be removed from the samples. If shell samples are not possible then parallel shell samples may be used. The tests shall cover:

- .1 Thickness of the laminates of the central shell wall and the ends.
- .2 Mass content and composition of composite reinforcement by ISO 1172:1996 or ISO 14127:2008, as well as orientation and arrangement of reinforcement layers.
- .3 Tensile strength, elongation at fracture and modulus of elasticity according to ISO 527-4:1997 or ISO 527-5:2009 for the circumferential and longitudinal directions of the shell. For areas of the FRP shell, tests shall be performed on representative laminates in accordance with ISO 527-4:1997 or ISO 527-5:2009, to permit evaluation of the suitability of safety factor ( $K$ ). A minimum of six specimens per measure of tensile strength shall be used, and the tensile strength shall be taken as the average minus two standard deviations.
- .4 Bending deflection and strength shall be established by the three-point or four-point bending test according to ISO 14125:1998 + Amd 1:2011 using a sample with a minimum width of 50 mm and a support distance of at least 20 times the wall thickness. A minimum of five specimens shall be used.
- .5 Creep factor  $\alpha$  shall be determined by taking the average result of at least two specimens with the configuration described in .4, subject to creep in three-point or four-point bending, at the maximum design temperature nominated under 6.10.2.2.3.2, for a period of 1,000 hours. The following test is to be undertaken for each specimen:
  - .1 Place specimen into bending apparatus, unloaded, in oven set to maximum design temperature and allow to acclimatize for a period of not less than 60 minutes.
  - .2 Load specimen bending in accordance with ISO 14125:1998 + Amd 1:2011 at flexural stress equal to the strength determined in .4 divided by four. Maintain mechanical load at maximum design temperature without interruption for not less than 1,000 hours;
  - .3 Measure the initial deflection six minutes after full load application in sub-paragraph .2 above. Specimen shall remain loaded in test rig.
  - .4 Measure the final deflection 1,000 hours after full load application in sub-paragraph .2 above.
  - .5 Calculate the creep factor  $\alpha$  by dividing the initial deflection from sub-paragraph .3 above by the final deflection from sub-paragraph .4 above.
- .6 Ageing factor  $\beta$  shall be determined by taking the average result of at least two specimens with the configuration described in .4, subject to loading in static three-point or four-point bending, in conjunction with immersion in water at the maximum design temperature nominated under 6.10.2.2.3.2 for a period of 1,000 hours. The following test is to be undertaken for each specimen:
  - .1 Prior to testing or conditioning, specimens shall be dried in an oven at 80°C for a period of 24 hours.
  - .2 The specimen shall be loaded in three-point or four-point bending at ambient temperature, in accordance with ISO 14125:1998 + Amd 1:2011, at the flexural stress level equal to the strength determined in .4 divided by four. Measure the initial deflection six minutes after full load application. Remove specimen from test rig.
  - .3 Immerse unloaded specimen in water at the maximum design temperature for a period of not less than 1,000 hours without interruption to the water conditioning period. When the conditioning period has lapsed, remove specimens, keep damp at ambient temperature, and complete sub-paragraph .4 below within three days.
  - .4 The specimen shall be subject to a second round of static loading, in a manner identical to sub-paragraph .2 above. Measure the final deflection six minutes after full load application. Remove specimen from test rig.
  - .5 Calculate the ageing factor  $\beta$  by dividing the initial deflection from sub-paragraph .2 above by the final deflection from sub-paragraph .4.
- .7 The interlaminar shear strength of the joints shall be measured by testing representative samples in accordance with ISO 14130:1997.
- .8 The efficiency of whichever is applicable of thermoplastic resin forming characteristics or thermoset resin cure and post-cure processes for laminates are to be determined using one or more of the following methods:
  - .1 direct measurement of formed thermoplastic resin characteristics or thermoset resin degree of cure: glass transition temperature ( $T_g$ ) or melting temperature ( $T_m$ ) determined using differential scanning calorimetry (DSC) via ISO 11357-2:2016; or
  - .2 indirect measurement of formed thermoplastic resin characteristics or thermoset resin degree of cure:
    - HDT via ISO 75-1:2013;
    - $T_g$  or  $T_m$  using thermo-mechanical analysis (TMA) via ISO 11359-1:2014;
    - dynamic thermo-mechanical analysis (DMA) via ISO 6721-11:2019;
    - Barcol testing via ASTM D2583:2013-03 or EN 59:2016.



## Chapter 6.10 – Provisions for portable tanks with shells made of FRP materials

**6.10.2.7.1.3** The chemical compatibility of the liner and chemical contact surfaces of service equipment with the substances to be carried shall be demonstrated by one of the following methods. This demonstration shall account for all aspects of the compatibility of the materials of the shell and its equipment with the substances to be carried, including chemical deterioration of the shell, initiation of critical reactions of the contents and dangerous reactions between both.

- .1 In order to establish any deterioration of the shell, representative samples taken from the shell, including any liners with welds, shall be subjected to the chemical compatibility test according to EN 977:1997 for a period of 1,000 hours at 50°C or the maximum temperature at which a particular substance is approved for transport. Compared with a virgin sample, the loss of strength and elasticity modulus measured by the bending test according to EN 978:1997 shall not exceed 25%. Cracks, bubbles, pitting effects as well as separation of layers and liners and roughness shall not be acceptable.
- .2 Certified and documented data of positive experiences on the compatibility of filling substances in question with the materials of the shell with which they come into contact at given temperatures, times and other relevant service conditions.
- .3 Technical data published in relevant literature, standards or other sources, acceptable to the competent authority.
- .4 Upon agreement with the competent authority other methods of chemical compatibility verification may be used.

**6.10.2.7.1.4** *Ball drop test as per EN 976-1:1997*

The prototype shall be subjected to the ball drop test according to EN 976-1:1997, No. 6.6. No visible damage inside or outside the tank shall occur.

**6.10.2.7.1.5** *Fire resistance test*

**6.10.2.7.1.5.1** A representative prototype tank with its service and structural equipment in place and filled to 80% of its maximum capacity with water, shall be exposed to a full engulfment in fire for 30 minutes, caused by an open heating oil pool fire or any other type of fire with the same effect. The fire shall be equivalent to a theoretical fire with a flame temperature of 800°C, emissivity of 0.9 and to the tank a heat transfer coefficient of 10 W/(m<sup>2</sup>K) and surface absorptivity of 0.8. A minimum net heat flux of 75 kW/m<sup>2</sup> shall be calibrated according to ISO 21843:2018. The dimensions of the pool shall exceed those of the tank by at least 50 cm to each side and the distance between fuel level and tank shall be between 50 cm and 80 cm. The rest of the tank below liquid level, including openings and closures, shall remain leakproof except for drips.

**6.10.2.8** **Inspection and testing**

**6.10.2.8.1** Inspection and testing of portable FRP tanks shall be carried out as per provisions of 6.7.2.19. In addition, welded thermoplastic liners shall be spark tested under a suitable standard, after pressure tests performed in accordance with the periodic inspections specified in 6.7.2.19.4.

**6.10.2.8.2** In addition, the initial and periodic inspections shall follow the service life inspection programme and any associated inspection methods per 6.10.2.6.3.

**6.10.2.8.3** The initial inspection and test shall verify that construction of the tank is made in accordance with the quality system required by 6.10.2.2.2.

**6.10.2.8.4** Additionally, during inspection of the shell the position of the areas heated by heating elements shall be indicated or marked, be available on design drawings or shall be made visible by a suitable technique (e.g. infrared). Examination of the shell shall take into account the effects of overheating, corrosion, erosion, overpressure and mechanical overloading.

**6.10.2.9** **Retention of samples**

Shell samples (e.g. from manhole cut-out) for each tank manufactured shall be maintained for future inspection and shell verification for a period of five years from the date of the initial inspection and test and until successful completion of the required 5-year periodic inspection.

**6.10.2.10** **Marking**

**6.10.2.10.1** The requirements of 6.7.2.20.1 apply to portable tanks with an FRP shell except those of 6.7.2.20.1(f)(ii).

**6.10.2.10.2** The information required in 6.7.2.20.1(f)(i) shall be “Shell structural material: Fibre-reinforced plastic”, the reinforcement fibre e.g. “Reinforcement: E-glass”, and resin e.g. “Resin: Vinyl Ester”.

**6.10.2.10.3** Requirements of provision 6.7.2.20.2 apply to portable tank with an FRP shell.





# **PART 7**

## **PROVISIONS CONCERNING TRANSPORT OPERATIONS**



# Chapter 7.1

## General stowage provisions

### 7.1.1 Introduction

This chapter contains the general provisions for the stowage of dangerous goods in all types of ships. Specific provisions applicable to, containerships, ro-ro ships, general cargo ships and barge-carrying ships, are stipulated in chapters 7.4 to 7.7.

### 7.1.2 Definitions

**Note 1:** The term “magazine” is no longer used in the context of the IMDG Code. A magazine that is not a fixed part of the ship shall meet the provisions for a closed cargo transport unit for class 1 (see 7.1.2). A magazine that is a fixed part of the ship such as compartment, below deck area or hold shall meet the provisions of 7.6.2.4.

**Note 2:** Cargo holds cannot be interpreted as closed cargo transport units.

*Clear of living quarters* means that packages or cargo transport units shall be stowed a minimum distance of 3 m from accommodation, air intakes, machinery spaces and other enclosed work areas.

*Closed cargo transport unit for class 1* means a unit which fully encloses the contents by permanent structures, can be secured to the ship’s structure and is, except for division 1.4, structurally serviceable as defined in this section. Cargo transport units with fabric sides or tops are not closed cargo transport units. The floor of any closed cargo transport unit shall either be constructed of wood, close-boarded, or so arranged that goods are stowed on sparred gratings, wooden pallets or dunnage.

*Combustible material* means material which may or may not be dangerous goods but which is easily ignited and supports combustion. Examples of combustible materials include wood, paper, straw, vegetable fibres, products made from such materials, coal, lubricants, and oils. This definition does not apply to packaging material or dunnage.

*Potential sources of ignition* means, but is not limited to, open fires, machinery exhausts, galley uptakes, electrical outlets and electrical equipment including those on refrigerated or heated cargo transport units unless they are of certified safe type.\*

*Protected from sources of heat* means that packages and cargo transport units shall be stowed at least 2.4 m from heated ship structures, where the surface temperature is liable to exceed 55°C. Examples of heated structures are steam pipes, heating coils, top or side walls of heated fuel and cargo tanks, and bulkheads of machinery spaces. In addition, packages not loaded inside a cargo transport unit and stowed on deck shall be shaded from direct sunlight. The surface of a cargo transport unit can heat rapidly when in direct sunlight in nearly windless conditions and the cargo may also become heated. Depending on the nature of the goods in the cargo transport unit and the planned voyage precautions shall be taken to ensure that exposure to direct sunlight is reduced.

*Stowage* means the proper placement of dangerous goods on board a ship in order to ensure safety and environmental protection during transport.

*Stowage on deck* means stowage on the weather deck. For open ro-ro cargo spaces see 7.5.2.6.

*Stowage under deck* means any stowage that is not on the weather deck. For hatchless containerships see 7.4.2.1.

*Structurally serviceable for class 1* means the cargo transport unit shall not have major defects in its structural components, e.g. top and bottom rails, top and bottom end rails, door sill and header, floor cross-members, corner posts, and corner fittings in a freight container. Major defects are: dents or bends in the structural

\* For cargo spaces, refer to SOLAS II-2/19.3.2 and for refrigerated or heated cargo transport units refer to recommendations published by the International Electrotechnical Commission, in particular IEC 60079.

Part 7 – Provisions concerning transport operations

members greater than 19 mm in depth, regardless of length; cracks or breaks in structural members; more than one splice (e.g. a lapped splice) in top or bottom end rails or door headers; more than two splices in any one top or bottom side rail or any splice in a door sill or corner post; door hinges and hardware that are seized, twisted, broken, missing or otherwise inoperative; gaskets and seals that do not seal; or, for freight containers, any distortion of the overall configuration great enough to prevent proper alignment of handling equipment, mounting and securing on chassis or vehicle, or insertion into ship's cells. In addition, deterioration in any component of the cargo transport unit, regardless of the material of construction, such as rusted-out metal in sidewalls or disintegrated fibreglass, is unacceptable. Normal wear, however, including oxidation (rust), slight dents and scratches and other damage that does not affect serviceability or the weathertight integrity of the units, is acceptable.

**7.1.3 Stowage categories**

**7.1.3.1 Stowage categories for class 1**

Dangerous goods of class 1 other than division 1.4, compatibility group S, packed in limited quantities shall be stowed as indicated in column 16a of the Dangerous Goods List in accordance with one of the categories specified below.

|                            |                       |  |
|----------------------------|-----------------------|--|
| <b>Stowage category 01</b> | Cargo ships           | On deck in closed cargo transport unit or under deck   |
|                            | (up to 12 passengers) |  |
|                            | Passenger ships       | On deck in closed cargo transport unit or under deck   |
| <b>Stowage category 02</b> | Cargo ships           | On deck in closed cargo transport unit or under deck   |
|                            | (up to 12 passengers) |  |
|                            | Passenger ships       | On deck in closed cargo transport unit or under deck in closed cargo transport unit in accordance with 7.1.4.4.6 |
| <b>Stowage category 03</b> | Cargo ships           | On deck in closed cargo transport unit or under deck   |
|                            | (up to 12 passengers) |  |
|                            | Passenger ships       | Prohibited except if in accordance with 7.1.4.4.6  |
| <b>Stowage category 04</b> | Cargo ships           | On deck in closed cargo transport unit or under deck in closed cargo transport unit                              |
|                            | (up to 12 passengers) |  |
|                            | Passenger ships       | Prohibited except if in accordance with 7.1.4.4.6  |
| <b>Stowage category 05</b> | Cargo ships           | On deck only in closed cargo transport unit  |
|                            | (up to 12 passengers) |  |
|                            | Passenger ships       | Prohibited except if in accordance with 7.1.4.4.6  |

**7.1.3.2 Stowage categories for classes 2 to 9**

Dangerous goods of classes 2 to 9 and division 1.4, compatibility group S, packed in limited quantities shall be stowed as indicated in column 16a of the Dangerous Goods List in accordance with one of the categories specified below:

**Stowage category A**

|   |   |                       |
|---|---|-----------------------|
| Cargo ships or passenger ships carrying a number of passengers limited to not more than 25 or to 1 passenger per 3 m of overall length, whichever is the greater number | } | ON DECK OR UNDER DECK |
| Other passenger ships in which the limiting number of passengers transported is exceeded  |   |                       |

**Stowage category B**

|   |   |                       |
|---|---|-----------------------|
| Cargo ships or passenger ships carrying a number of passengers limited to not more than 25 or to 1 passenger per 3 m of overall length, whichever is the greater number | } | ON DECK OR UNDER DECK |
| Other passenger ships in which the limiting number of passengers transported is exceeded  |   |                       |

**Stowage category C**

|   |   |              |
|---|---|--------------|
| Cargo ships or passenger ships carrying a number of passengers limited to not more than 25 or to 1 passenger per 3 m of overall length, whichever is the greater number | } | ON DECK ONLY |
| Other passenger ships in which the limiting number of passengers transported is exceeded  |   | ON DECK ONLY |

**Stowage category D**

|   |   |              |
|---|---|--------------|
| Cargo ships or passenger ships carrying a number of passengers limited to not more than 25 or to 1 passenger per 3 m of overall length, whichever is the greater number | } | ON DECK ONLY |
| Other passenger ships in which the limiting number of passengers transported is exceeded  |   | PROHIBITED   |

**Stowage category E**

|   |   |                       |
|---|---|-----------------------|
| Cargo ships or passenger ships carrying a number of passengers limited to not more than 25 or to 1 passenger per 3 m of overall length, whichever is the greater number | } | ON DECK OR UNDER DECK |
| Other passenger ships in which the limiting number of passengers transported is exceeded  |   | PROHIBITED            |

**7.1.4 Special stowage provisions**

**7.1.4.1 Stowage of empty uncleaned packagings, including IBCs and large packagings**

Notwithstanding the stowage provisions given in the Dangerous Goods List, empty uncleaned packagings, including IBCs and large packagings, which shall be stowed *on deck only* when full may be stowed *on deck or under deck* in a mechanically ventilated cargo space. However, empty uncleaned pressure receptacles which carry a label of class 2.3 shall be stowed *on deck only* (see also 4.1.1.11) and waste aerosols shall only be stowed according to column 16a of the Dangerous Goods List.

**7.1.4.2 Stowage of marine pollutants and infectious substances of UN 2814, UN 2900 and UN 3549**

Where stowage is permitted *on deck or under deck*, *under deck* stowage is preferred. Where stowage *on deck only* is required, preference shall be given to stowage on well-protected decks or to stowage inboard in sheltered areas of exposed decks.

**7.1.4.3 Stowage of limited quantities and excepted quantities**

For the stowage of limited quantities and excepted quantities see chapters 3.4 and 3.5.

**7.1.4.4 Stowage of goods of class 1**

**7.1.4.4.1** In cargo ships of 500 gross tons or over and passenger ships constructed before 1 September 1984 and in cargo ships of less than 500 gross tons constructed before 1 February 1992, goods of class 1 with the exception of division 1.4, compatibility group S, shall be stowed *on deck only*, unless otherwise approved by the Administration.

**7.1.4.4.2** Goods of class 1 with the exception of division 1.4 shall be stowed not less than a horizontal distance of 12 m from living quarters, life-saving appliances\* and areas where the ship's passengers can access without any authorization or limitation.

**7.1.4.4.3** Goods of class 1 with the exception of division 1.4 shall not be positioned closer to the ship's side than a distance equal to one eighth of the beam or 2.4 m, whichever is the lesser.

**7.1.4.4.4** Goods of class 1 shall not be stowed within a horizontal distance of 6 m from potential sources of ignition.

**7.1.4.4.5 Transport to or from offshore oil platforms, mobile offshore drilling units and other offshore installations**

Notwithstanding the stowage category indicated in column 16a of the Dangerous Goods List, UN 0124 JET PERFORATING GUNS, CHARGED, and UN 0494 JET PERFORATING GUNS, CHARGED, transported to or from offshore oil platforms, mobile offshore drilling units and other offshore installations may be stowed on deck in offshore well tool pallets, cradles or baskets provided that:

- .1 initiation devices shall be segregated from each other and from any jet perforating guns in accordance with the provisions of 7.2.7, and from any other dangerous goods in accordance with the provisions of 7.2.4 and 7.6.3.2, unless otherwise approved by the competent authority;

\* Refer to the *Unified interpretation on 7.1.4.4.2 of the IMDG Code* on the issue of "life-saving appliances" (MSC.1/Circ.1626).



Part 7 – Provisions concerning transport operations

- .2 jet perforating guns shall be securely held in place during transport;
- .3 each shaped charge affixed to any gun shall not contain more than 112 g of explosives;
- .4 each shaped charge, if not completely enclosed in glass or metal, shall be fully protected by a metal cover following installation in the gun;
- .5 both ends of jet perforating guns shall be protected by means of steel end caps allowing for pressure release in the event of fire;
- .6 the total explosive content shall not exceed 95 kg per well tool pallet, cradle or basket; and
- .7 where more than one well tool pallet, cradle or basket is stowed "on deck", a minimum horizontal distance of 3 m shall be observed between them.

7.1.4.4.6 **Stowage on passenger ships**

7.1.4.4.6.1 Goods in division 1.4, compatibility group S, may be transported in any amount on passenger ships. No other goods of class 1 may be transported on passenger ships except:

- .1 goods in compatibility groups C, D and E and articles in compatibility group G, if the total net explosive mass does not exceed 10 kg per ship and if they are transported in closed cargo transport units *on deck or under deck*;
- .2 articles in compatibility group B, if the total net explosive mass does not exceed 10 kg per ship and if they are transported *on deck only* in closed cargo transport units.

7.1.4.4.7 Alternative arrangements to those prescribed in chapter 7.1 for class 1 may be approved by the Administration.

7.1.4.5 **Stowage of goods of class 7**

7.1.4.5.1 The total activity in a single cargo space of a sea going vessel for transport of LSA material or SCO in Type IP 1, Type IP 2, Type IP 3 packaging or unpackaged shall not exceed the limits shown in the table hereunder. For SCO-III, the limits in the table hereunder may be exceeded provided that the transport plan contains precautions which are to be employed during transport to obtain an overall level of safety at least equivalent to that which would be provided if the limits had been applied.

**Conveyance activity limits for LSA material and SCO  
in industrial packages or unpackaged**

| Nature of material  | Activity limit for a seagoing vessel |
|---|--------------------------------------|
| LSA I   | No limit                             |
| LSA II and LSA III non-combustible solids                           | No limit                             |
| LSA II and LSA III combustible solids,<br>and all liquids and gases | 100A <sub>2</sub>                    |
| SCO   | 100A <sub>2</sub>                    |

7.1.4.5.2 Provided that its average surface heat flux does not exceed 15 W/m<sup>2</sup> and that the immediately surrounding cargo is not in sacks or bags, a package or overpack may be transported or stored among packaged general cargo without any special stowage provisions except as may be specifically required by the competent authority in an applicable certificate of approval.

7.1.4.5.3 Loading of freight containers and accumulation of packages, overpacks and freight containers shall be controlled as follows:

- .1 Except under the condition of exclusive use, the total number of packages, overpacks and freight containers aboard a single conveyance shall be so limited that the total sum of the transport indexes aboard the conveyance does not exceed the values shown in the table hereunder. For consignments of LSA I material there shall be no limit on the sum of the transport indexes.

TI limits for freight containers and conveyances not under exclusive use

| Type of freight container or conveyance         | Limit on total sum of transport indexes in a freight container or aboard a conveyance |
|---|---|
| Freight container                               |   |
| Small freight container                         | 50  |
| Large freight container                         | 50  |
| Vehicle   | 50  |
| Inland water-way vessel (barge)                 | 50  |
| Seagoing vessel <sup>a</sup>                    |   |
| 1 <i>Hold, compartment or defined deck area</i> |   |
| Packages, overpacks, small freight containers   | 50  |
| Large freight containers (closed containers)    | 200   |
| 2 <i>Total vessel</i>                           |   |
| Packages, overpacks, small freight containers   | 200   |
| Large freight containers (closed containers)    | No limit  |

<sup>a</sup> Packages or overpacks transported in or on a vehicle which are in accordance with the provisions of 7.1.4.5.5 may be transported by vessels provided that they are not removed from the vehicle at any time while on board the ship.

- .2 Where a consignment is transported under exclusive use, there shall be no limit on the sum of the transport indexes aboard a single conveyance.
- .3 The dose rate under routine conditions of transport shall not exceed 2 mSv/h at any point on the external surface of the vehicle or freight container, and 0.1 mSv/h at 2 m from the external surface of the vehicle or freight container, except for consignments transported under exclusive use by road or rail for which the dose rate limits around the vehicle are set forth in 7.1.4.5.5.2 and 7.1.4.5.5.3.
- .4 The total sum of the criticality safety indexes in a freight container and aboard a conveyance shall not exceed the values shown in the table hereunder.

CSI limits for freight containers and conveyances containing fissile material

| Type of freight container or conveyance         | Limit on total sum of criticality safety indexes in a freight container or aboard a conveyance |                       |
|---|--|-----------------------|
|   | Not under exclusive use  | Under exclusive use   |
| Freight container                               |  |                       |
| Small freight container                         | 50   | n.a.                  |
| Large freight container                         | 50   | 100                   |
| Vehicle   | 50   | 100                   |
| Inland water-way vessel (barge)                 | 50   | 100                   |
| Seagoing vessel <sup>a</sup>                    |  |                       |
| 1 <i>Hold, compartment or defined deck area</i> |  |                       |
| Packages, overpacks, small freight containers   | 50   | 100                   |
| Large freight containers (closed containers)    | 50   | 100                   |
| 2 <i>Total vessel</i>                           |  |                       |
| Packages, overpacks, small freight containers   | 200 <sup>b</sup>   | 200 <sup>c</sup>      |
| Large freight containers (closed containers)    | No limit <sup>b</sup>  | No limit <sup>c</sup> |

<sup>a</sup> Packages or overpacks transported in or on a vehicle which are in accordance with the provisions of 7.1.4.5.5 may be transported by ships provided that they are not removed from the vehicle at any time while on board the ship. In that case, the entries under the heading “under exclusive use” apply.

<sup>b</sup> The consignment shall be so handled and stowed that the total sum of CSIs in any group does not exceed 50, and that each group is handled and stowed so as to maintain a spacing of at least 6 m from other groups.

<sup>c</sup> The consignment shall be so handled and stowed that the total sum of CSIs in any group does not exceed 100, and that each group is handled and stowed so as to maintain a spacing of at least 6 m from other groups. The intervening space between groups may be occupied by other cargo.

- 7.1.4.5.4 Any package or overpack having either a transport index greater than 10, or any consignment having a criticality safety index greater than 50, shall be transported only under exclusive use.

**Part 7 – Provisions concerning transport operations**

- 7.1.4.5.5 For consignments under exclusive use, the dose rate shall not exceed:
- .1 10 mSv/h at any point on the external surface of any package or overpack, and may only exceed 2 mSv/h provided that:
    - .1 the vehicle is equipped with an enclosure which, during routine conditions of transport, prevents the access of unauthorized persons to the interior of the enclosure, and
    - .2 provisions are made to secure the package or overpack so that its position within the vehicle enclosure remains fixed during routine conditions of transport, and
    - .3 there is no loading or unloading during the shipment;
  - .2 2 mSv/h at any point on the outer surfaces of the vehicle, including the upper and lower surfaces, or, in the case of an open vehicle, at any point on the vertical planes projected from the outer edges of the vehicle, on the upper surface of the load, and on the lower external surface of the vehicle; and
  - .3 0.1 mSv/h at any point 2 m from the vertical planes represented by the outer lateral surfaces of the vehicle, or, if the load is transported in an open vehicle, at any point 2 m from the vertical planes projected from the outer edges of the vehicle.
- 7.1.4.5.6 In the case of road vehicles, no persons other than the driver and assistants shall be permitted in vehicles carrying packages, overpacks or freight containers bearing category II-YELLOW or III-YELLOW labels.
- 7.1.4.5.7 Packages or overpacks having a surface dose rate greater than 2 mSv/h, unless being transported in or on a vehicle under exclusive use in accordance with the table under 7.1.4.5.3, footnote (a), shall not be transported by ship except under special arrangement.
- 7.1.4.5.8 The transport of consignments by means of a special use ship which, by virtue of its design or by reason of its being chartered, is dedicated to the purpose of carrying radioactive material shall be excepted from the provisions specified in 7.1.4.5.3 provided that the following conditions are met:
- .1 a radiation protection programme for the shipment shall be approved by the Administration and, when requested, by the competent authority at each port of call;
  - .2 stowage arrangements shall be predetermined for the whole voyage, including any consignments to be loaded at ports of call en route; and
  - .3 the loading, transport and unloading of the consignments shall be supervised by persons qualified in the transport of radioactive material.
- 7.1.4.5.9 Any conveyance and equipment used regularly for the transport of radioactive material shall be periodically checked to determine the level of contamination. The frequency of such checks shall be related to the likelihood of contamination and the extent to which radioactive material is transported.
- 7.1.4.5.10 Except as provided in 7.1.4.5.11, any conveyance, or equipment or part thereof, which has become contaminated above the limits specified in 4.1.9.1.2 in the course of the transport of radioactive material, or which shows a dose rate in excess of 5  $\mu$ Sv/h at the surface, shall be decontaminated as soon as possible by a qualified person and shall not be re-used unless the following conditions are fulfilled:
- .1 the non-fixed contamination shall not exceed the limits specified in 4.1.9.1.2;
  - .2 the dose rate resulting from the fixed contamination shall not exceed 5  $\mu$ Sv/h at the surface.
- 7.1.4.5.11 A freight container or conveyance dedicated to the transport of unpackaged radioactive material under exclusive use shall be excepted from the provisions of 4.1.9.1.4 and 7.1.4.5.10 solely with regard to its internal surfaces and only for as long as it remains under that specific exclusive use.
- 7.1.4.5.12 Where a consignment is undeliverable, the consignment shall be placed in a safe location and the appropriate competent authority shall be informed as soon as possible and a request made for instructions on further action.
- 7.1.4.5.13 Radioactive material shall be segregated sufficiently from crew and passengers. The following values for dose shall be used for the purpose of calculating segregation distances or dose rates:
- .1 for crew in regularly occupied working areas, a dose of 5 mSv in a year;
  - .2 for passengers, in areas where the passengers have regular access, a dose of 1 mSv in a year, taking account of the exposures expected to be delivered by all other relevant sources and practices under control.
- 7.1.4.5.14 Category II-YELLOW or III-YELLOW packages or overpacks shall not be transported in spaces occupied by passengers, except those exclusively reserved for couriers specially authorized to accompany such packages or overpacks.

- 7.1.4.5.15 Any group of packages, overpacks and freight containers containing fissile material stored in transit in any one storage area shall be so limited that the total sum of the criticality safety indexes in the group does not exceed 50. Each group shall be stored so as to maintain a spacing of at least 6 m from other such groups.
- 7.1.4.5.16 Where the total sum of the criticality safety indexes on board a conveyance or in a freight container exceeds 50, as permitted in the table under 7.1.4.5.3.4, storage shall be such as to maintain a spacing of at least 6 m from other groups of packages, overpacks or freight containers containing fissile material or other conveyances carrying radioactive material.
- 7.1.4.5.17 Any departure from the provisions in 7.1.4.5.15 and 7.1.4.5.16 shall be approved by the Administration and, when requested, by the competent authority at each port of call.
- 7.1.4.5.18 The segregation requirements specified in 7.1.4.5.13 may be established in one of the following two ways:
- by following the segregation table for persons (table 7.1.4.5.18) in respect of living quarters or spaces regularly occupied by persons.
  - by demonstration that, for the following indicated exposure times, the direct measurement of the dose rate in regularly occupied spaces and living quarters is less than:  
  
*for the crew:*  
0.0070 mSv/h up to 700 h in a year, or  
0.0018 mSv/h up to 2750 h in a year; and  
  
*for the passengers:*  
0.0018 mSv/h up to 550 h in a year,  
taking into account any relocation of cargo during the voyage. In all cases, the measurements of dose rate must be made and documented by a suitably qualified person.
- 7.1.4.6 **Stowage of dangerous goods under temperature control**
- 7.1.4.6.1 When stowage arrangements are made, it shall be borne in mind that it may become necessary to take the appropriate emergency action, such as jettisoning or flooding of the container with water, and the temperature needs to be monitored in accordance to 7.3.7. If, during transport, the control temperature is exceeded, an alerting procedure shall be initiated involving either repair of the refrigeration machinery or an increase in the cooling capacity (such as by adding liquid or solid refrigerants). If an adequate cooling capacity is not restored, emergency procedures shall be started.
- 7.1.4.7 **Stowage of stabilized dangerous goods**
- For substances, for which the word “STABILIZED” is added as part of the proper shipping name of the substances in accordance with 3.1.2.6, Stowage Category D and SW1 shall apply.

Part 7 – Provisions concerning transport operations

Table 7.1.4.5.18 – CLASS 7 – Radioactive material  
Segregation table for persons

| Sum of transport indices (TI)       | Segregation distance of radioactive material from passengers and crew |                                |  |                                       |
|-------------------------------------|---|--------------------------------|--|---------------------------------------|
|                                     | General cargo ship <sup>1</sup>                                       |                                | Ferry, etc. <sup>2</sup>   | Offshore support vessel <sup>3</sup>  |
|                                     | Break bulk (m)  | Containers (TEUs) <sup>4</sup> |  |                                       |
| Up to 10                            | 6   | 1                              | Stow at bow or stern furthest from living quarters and regularly occupied work areas | Stow at stern or at platform midpoint |
| More than 10 but not more than 20   | 8   | 1                              | as above   | as above                              |
| More than 20 but not more than 50   | 13  | 2                              | as above   | not applicable                        |
| More than 50 but not more than 100  | 18  | 3                              | as above   | not applicable                        |
| More than 100 but not more than 200 | 26  | 4                              | as above   | not applicable                        |
| More than 200 but not more than 400 | 36  | 6                              | as above   | not applicable                        |

<sup>1</sup> General cargo, break bulk or ro-ro containership of 150 m minimum length.

<sup>2</sup> Ferry or cross channel, coastal and inter-island ship of 100 m minimum length.

<sup>3</sup> Offshore support vessel of 50 m minimum length (in this case the practical maximum sum of TIs carried is 20).

<sup>4</sup> TEU means "20 ft Equivalent Unit" (this is equivalent to a standard freight container of 6 m nominal length).

### 7.1.5 Stowage codes

The stowage codes given in column 16a of the Dangerous Goods List are as specified below:

| Stowage code | Description   |
|--------------|---|
| SW1          | Protected from sources of heat.   |
| SW2          | Clear of living quarters.   |
| SW3          | Shall be transported under temperature control.   |
| SW4          | Surface ventilation is required to assist in removing any residual solvent vapour.  |
| SW5          | If under deck, stow in a mechanically ventilated space.   |
| SW6          | When stowed under deck, mechanical ventilation shall be in accordance with SOLAS regulation II-2/19 (II-2/54) for flammable liquids with flashpoint below 23°C c.c.   |
| SW7          | As approved by the competent authorities of the countries involved in the shipment.   |
| SW8          | Ventilation may be required. The possible need to open hatches in case of fire to provide maximum ventilation and to apply water in an emergency, and the consequent risk to the stability of the ship through flooding of the cargo spaces, shall be considered before loading.  |
| SW9          | Provide a good through ventilation for bagged cargo. Double strip stowage is recommended. The illustration in 7.6.2.7.2.3 shows how this can be achieved. During the voyage regular temperature readings shall be taken at varying depths in the hold and recorded. If the temperature of the cargo exceeds the ambient temperature and continues to increase, ventilation shall be closed down.  |
| SW10         | Unless carried in closed cargo transport units, bales shall be properly covered by tarpaulins or the like. Cargo spaces shall be clean, dry and free from oil or grease. Ventilator cowls leading into the cargo space shall have sparking-preventing screens. All other openings, entrances and hatches leading to the cargo space shall be securely closed. During temporary interruption of loading, when the hatch remains uncovered, a fire-watch shall be kept. During loading or discharge, smoking in the vicinity shall be prohibited and fire-fighting appliances kept ready for immediate operation. |

| Stowage code | Description  |
|--------------|--|
| SW11         | Cargo transport units shall be shaded from direct sunlight. Packages in cargo transport units shall be stowed so as to allow for adequate air circulation throughout the cargo.  |
| SW12         | Taking account of any supplementary requirements specified in the transport documents.   |
| SW13         | Taking account of any supplementary requirements specified in the competent authority approval certificate(s).   |
| SW14         | Category A only if the special stowage provisions of 7.4.1.4 and 7.6.2.8.4 are complied with.  |
| SW15         | For metal drums, stowage category B.   |
| SW16         | For unit loads in open cargo transport units, stowage category B.  |
| SW17         | Category E, for closed cargo transport unit and pallet boxes only. Ventilation may be required. The possible need to open hatches in case of fire to provide maximum ventilation and to apply water in an emergency, and the consequent risk to the stability of the ship through flooding of the cargo space, shall be considered before loading. |
| SW18         | Category A, when transported in accordance with P650.  |
| SW19         | For batteries transported in accordance with special provisions 376 or 377, category C, unless transported on a short international voyage.  |
| SW20         | For uranyl nitrate hexahydrate solution stowage, category D applies.   |
| SW21         | For uranium metal pyrophoric and thorium metal pyrophoric stowage, category D applies.   |
| SW22         | For AEROSOLS with a maximum capacity of 1 L: category A.<br>For AEROSOLS with a capacity above 1 L: category B.<br>For WASTE AEROSOLS or WASTE GAS CARTRIDGES: category C, clear of living quarters.   |
| SW23         | When transported in BK3 bulk container, see 7.6.2.12 and 7.7.3.9.  |
| SW24         | For special stowage provisions, see 7.4.1.3 and 7.6.2.7.2.   |
| SW25         | For special stowage provisions, see 7.6.2.7.3.   |
| SW26         | For special stowage provisions, see 7.4.1.4 and 7.6.2.11.1.1.  |
| SW27         | For special stowage provisions, see 7.6.2.7.2.1.   |
| SW28         | As approved by the competent authority of the country of origin.   |
| SW29         | For engines or machinery containing fuels with flashpoint equal or greater than 23°C, stowage Category A.  |
| SW30         | For special stowage provisions, see 7.1.4.4.5.   |
| SW31         | Stow away from potential sources of ignition, as determined in 7.4.2.3.2 or 7.5.2.8 or 7.6.2.2.2, as applicable.   |

## 7.1.6 Handling codes

The handling codes given in column 16a of the Dangerous Goods List are as specified below:

| Handling code | Description  |
|---------------|--|
| H1            | Keep as dry as reasonably practicable.   |
| H2            | Keep as cool as reasonably practicable.  |
| H3            | During transport, it should be stowed (or kept) in a cool ventilated place.  |
| H4            | If cleaning of cargo spaces has to be carried out at sea, the safety procedures followed and standard of equipment used shall be at least as effective as those employed as industry best practice in a port. Until such cleaning is undertaken, the cargo spaces in which the asbestos has been carried shall be closed and access to those spaces shall be prohibited. |
| H5            | Avoid handling the packaging or large packaging or keep handling to a minimum. Inform the appropriate public health authority or veterinary authority where persons or animals may have been exposed.  |

## Chapter 7.2

### *General segregation provisions*

---

#### 7.2.1 Introduction

This chapter contains the general provisions for the segregation of goods which are mutually incompatible.

Additional segregation provisions are given in:

- 7.3 Consigning operations concerning the packing and use of cargo transport units (CTUs) and related provisions;
- 7.4 Stowage and segregation on containerships;
- 7.5 Stowage and segregation on roll-on/roll-off ships;
- 7.6 Stowage and segregation on general cargo ships; and
- 7.7 Shipborne barges on barge-carrying ships.

#### 7.2.2 Definition

##### 7.2.2.1 Segregation

*Segregation* is the process of separating two or more substances or articles which are considered mutually incompatible when their packing or stowage together may result in undue hazards in case of leakage or spillage, or any other accident.

However, as the extent of the hazard arising may vary, the segregation arrangements required may also vary as appropriate. Segregation is obtained by maintaining certain distances between incompatible dangerous goods or by requiring the presence of one or more steel bulkheads or decks between them, or a combination thereof. Intervening spaces between such dangerous goods may be filled with other cargo compatible with the dangerous substances or articles in question.

##### 7.2.2.2 Segregation terms

The following segregation terms that are used throughout this Code are defined in other chapters of this part as they apply to packing cargo transport units and segregation on board different ship types:

- .1 "away from";
- .2 "separated from";
- .3 "separated by a complete compartment or hold from";
- .4 "separated longitudinally by an intervening complete compartment or hold from".

Segregation terms such as "away from class ..." that are used in the Dangerous Goods List, "class ..." is deemed to include:

- .1 all substances within "class ..."; and
- .2 all substances for which a subsidiary hazard label of "class ..." is required.

#### 7.2.3 Segregation provisions

7.2.3.1 To determine the segregation requirements between two or more dangerous goods, the segregation provisions, including the segregation table (7.2.4) and column 16b of the Dangerous Goods List shall be consulted, see also the annex to this chapter. In case of conflicting provisions, the provisions of column 16b of the Dangerous Goods List, always take precedence.

7.2.3.2 Whenever a segregation term applies (see 7.2.2.2), the goods are:

- .1 not permitted to be packed in the same outer packaging; and
- .2 not permitted to be transported in the same cargo transport unit except as provided in 7.2.6 and 7.3.4.

For "limited quantities" and "excepted quantities" see chapters 3.4 and 3.5.



**7.2.3.3** Where the provisions of this Code indicate a single secondary hazard (one subsidiary hazard label), the segregation provisions applicable to that hazard shall take precedence where they are more stringent than those of the primary hazard. The segregation provisions corresponding to a subsidiary hazard of class 1 are those for class 1 division 1.3.

**7.2.3.4** The segregation provisions for substances, materials or articles having more than two hazards (two or more subsidiary hazard labels) are given in column 16b of the Dangerous Goods List.

For example:

In the Dangerous Goods List entry for BROMINE CHLORIDE, class 2.3, UN 2901, subsidiary hazards 5.1 and 8, the following particular segregation is specified:

“SG6 (segregation as for class 5.1), and SG19 (stow “separated from” class 7).”

## 7.2.4 Segregation table

The general provisions for segregation between the various classes of dangerous goods are shown in the “segregation table” given below.

Since the properties of substances, materials or articles within each class may vary greatly, the Dangerous Goods List shall always be consulted for particular provisions for segregation as, in the case of conflicting provisions, these take precedence over the general provisions.

Segregation shall also take account of a single subsidiary hazard label.

| CLASS   | 1.1<br>1.2<br>1.5 | 1.3<br>1.6 | 1.4 | 2.1 | 2.2 | 2.3 | 3 | 4.1 | 4.2 | 4.3 | 5.1 | 5.2 | 6.1 | 6.2 | 7 | 8 | 9 |
|---|-------------------|------------|-----|-----|-----|-----|---|-----|-----|-----|-----|-----|-----|-----|---|---|---|
| Explosives 1.1, 1.2, 1.5  | *                 | *          | *   | 4   | 2   | 2   | 4 | 4   | 4   | 4   | 4   | 4   | 2   | 4   | 2 | 4 | X |
| Explosives 1.3, 1.6   | *                 | *          | *   | 4   | 2   | 2   | 4 | 3   | 3   | 4   | 4   | 4   | 2   | 4   | 2 | 2 | X |
| Explosives 1.4  | *                 | *          | *   | 2   | 1   | 1   | 2 | 2   | 2   | 2   | 2   | 2   | X   | 4   | 2 | 2 | X |
| Flammable gases 2.1   | 4                 | 4          | 2   | X   | X   | X   | 2 | 1   | 2   | 2   | 2   | 2   | X   | 4   | 2 | 1 | X |
| Non-toxic, non-flammable gases 2.2  | 2                 | 2          | 1   | X   | X   | X   | 1 | X   | 1   | X   | X   | 1   | X   | 2   | 1 | X | X |
| Toxic gases 2.3   | 2                 | 2          | 1   | X   | X   | X   | 2 | X   | 2   | X   | X   | 2   | X   | 2   | 1 | X | X |
| Flammable liquids 3   | 4                 | 4          | 2   | 2   | 1   | 2   | X | X   | 2   | 2   | 2   | 2   | X   | 3   | 2 | X | X |
| Flammable solids, self-reactive substances, solid desensitized explosives and polymerizing substances 4.1 | 4                 | 3          | 2   | 1   | X   | X   | X | X   | 1   | X   | 1   | 2   | X   | 3   | 2 | 1 | X |
| Substances liable to spontaneous combustion 4.2   | 4                 | 3          | 2   | 2   | 1   | 2   | 2 | 1   | X   | 1   | 2   | 2   | 1   | 3   | 2 | 1 | X |
| Substances which, in contact with water, emit flammable gases 4.3   | 4                 | 4          | 2   | 2   | X   | X   | 2 | X   | 1   | X   | 2   | 2   | X   | 2   | 2 | 1 | X |
| Oxidizing substances (agents) 5.1   | 4                 | 4          | 2   | 2   | X   | X   | 2 | 1   | 2   | 2   | X   | 2   | 1   | 3   | 1 | 2 | X |
| Organic peroxides 5.2   | 4                 | 4          | 2   | 2   | 1   | 2   | 2 | 2   | 2   | 2   | 2   | X   | 1   | 3   | 2 | 2 | X |
| Toxic substances 6.1  | 2                 | 2          | X   | X   | X   | X   | X | X   | 1   | X   | 1   | 1   | X   | 1   | X | X | X |
| Infectious substances 6.2   | 4                 | 4          | 4   | 4   | 2   | 2   | 3 | 3   | 3   | 2   | 3   | 3   | 1   | X   | 3 | 3 | X |
| Radioactive material 7  | 2                 | 2          | 2   | 2   | 1   | 1   | 2 | 2   | 2   | 2   | 1   | 2   | X   | 3   | X | 2 | X |
| Corrosive substances 8  | 4                 | 2          | 2   | 1   | X   | X   | X | 1   | 1   | 1   | 2   | 2   | X   | 3   | 2 | X | X |
| Miscellaneous dangerous substances and articles 9   | X                 | X          | X   | X   | X   | X   | X | X   | X   | X   | X   | X   | X   | X   | X | X | X |

The numbers and symbols in the table have the following meanings:

- 1 – “away from”
- 2 – “separated from”
- 3 – “separated by a complete compartment or hold from”
- 4 – “separated longitudinally by an intervening complete compartment or hold from”
- X – the Dangerous Goods List has to be consulted to verify whether there are specific segregation provisions
- \* – see 7.2.7.1 of this chapter for the segregation provisions between class 1 substances or articles

**Part 7 – Provisions concerning transport operations****7.2.5 Segregation groups**

7.2.5.1 For the purpose of segregation, dangerous goods having certain similar chemical properties have been grouped together in segregation groups as listed in 7.2.5.2. The entries allocated to these segregation groups are listed in 3.1.4.4 and are identified by a segregation group code in column 16b of the Dangerous Goods List.

7.2.5.2 The segregation group codes given in column 16b of the Dangerous Goods List are as specified below:

| Segregation Group Code | Segregation Group | Description   |
|------------------------|-------------------|---|
| SGG1                   | 1                 | acids   |
| SGG2                   | 2                 | ammonium compounds  |
| SGG3                   | 3                 | bromates  |
| SGG4                   | 4                 | chlorates   |
| SGG5                   | 5                 | chlorites   |
| SGG6                   | 6                 | cyanides  |
| SGG7                   | 7                 | heavy metals and their salts (including their organometallic compounds) |
| SGG8                   | 8                 | hypochlorites   |
| SGG9                   | 9                 | lead and its compounds  |
| SGG10                  | 10                | liquid halogenated hydrocarbons   |
| SGG11                  | 11                | mercury and mercury compounds   |
| SGG12                  | 12                | nitrites and their mixtures   |
| SGG13                  | 13                | perchlorates  |
| SGG14                  | 14                | permanganates   |
| SGG15                  | 15                | powdered metals   |
| SGG16                  | 16                | peroxides   |
| SGG17                  | 17                | azides  |
| SGG18                  | 18                | alkalis   |

7.2.5.3 It is recognized that not all substances, mixtures, solutions or preparations falling within a segregation group are listed in the IMDG Code by name. These are shipped under N.O.S. entries. Although these N.O.S. entries are not themselves listed in the segregation groups (see 3.1.4.4), the consignor shall decide whether inclusion under the segregation group is appropriate and, if so, shall mention that fact in the transport document (see 5.4.1.5.11).

7.2.5.4 The segregation groups in this Code do not cover substances which fall outside the classification criteria of this Code. It is recognized that some non-hazardous substances have similar chemical properties as substances listed in the segregation groups. A consignor or the person responsible for packing the goods into a cargo transport unit who does have knowledge of the chemical properties of such non-dangerous goods may decide to implement the segregation requirements of a related segregation group on a voluntary basis.

**7.2.6 Special segregation provisions and exemptions**

△ 7.2.6.1 Notwithstanding 7.2.3.3 and 7.2.3.4, substances of the same class may be stowed together without regard to segregation required by secondary hazards (subsidiary hazard label(s)), provided that the substances do not react dangerously with each other and do not cause:

- .1 combustion and/or evolution of considerable heat;
- .2 evolution of flammable, toxic or asphyxiant gases;
- .3 the formation of corrosive substances; or
- .4 the formation of unstable substances.

**7.2.6.2** Where the Dangerous Goods List specifies that “segregation as for class ...” applies, the segregation provisions applicable to that class in 7.2.4 shall be applied. However, for the purposes of interpreting 7.2.6.1, which permits substances of the same class to be stowed together provided they do not react dangerously with each other, the segregation provisions of the class as represented by the primary hazard class in the Dangerous Goods List shall be applied.

For example:

UN 2965 – BORON TRIFLUORIDE DIMETHYL ETHERATE, class 4.3

The Dangerous Goods List entry specifies “SG5 (segregation as for class 3), SG8 (stow “away from” class 4.1), SG13 (stow “away from” class 8), SG25 (stow “separated from” goods of classes 2.1 and 3) and SG26 (in addition: from goods of classes 2.1 and 3 when stowed on deck of a containership a minimum distance of two container spaces athwartship shall be maintained, when stowed on ro-ro ships a distance of 6m athwartship shall be maintained.)”.

For the purposes of establishing the segregation provisions applicable in 7.2.4, the class 3 column shall be consulted.

This substance may be stowed together with other class 4.3 substances where they do not react dangerously with each other, see 7.2.6.1.

**7.2.6.3** No segregation needs to be applied:

- .1 between dangerous goods of different classes which comprise the same substance but vary only in their water content, such as sodium sulphide in classes 4.2 and 8 or for class 7 if the difference is due to quantity only;
- .2 between dangerous goods which belong to a group of substances of different classes but for which scientific evidence exists that they do not react dangerously when in contact with each other. Substances within the same table 7.2.6.3.1, 7.2.6.3.2 or 7.2.6.3.3 are compatible with one another; and
- .3 to substances within the table 7.2.6.3.4, except that due regard shall continue to be taken of the dangerous reactions specified in the provisions of 7.2.6.1.1 to 7.2.6.1.4.

Table 7.2.6.3.1

| UN   | Proper shipping name   | Class | Subsidiary hazard(s) | Packing group |
|------|--|-------|----------------------|---------------|
| 2014 | HYDROGEN PEROXIDE, AQUEOUS SOLUTION with not less than 20% but not more than 60% hydrogen peroxide (stabilized as necessary) | 5.1   | 8                    | II            |
| 2984 | HYDROGEN PEROXIDE, AQUEOUS SOLUTION with not less than 8% but less than 20% hydrogen peroxide (stabilized as necessary)      | 5.1   |                      | III           |
| 3105 | ORGANIC PEROXIDE TYPE D, LIQUID (peroxyacetic acid, type D, stabilized)  | 5.2   | 8                    |               |
| 3107 | ORGANIC PEROXIDE TYPE E, LIQUID (peroxyacetic acid, type E, stabilized)  | 5.2   | 8                    |               |
| 3109 | ORGANIC PEROXIDE TYPE F, LIQUID (peroxyacetic acid, type F, stabilized)  | 5.2   | 8                    |               |
| 3149 | HYDROGEN PEROXIDE AND PEROXYACETIC ACID, MIXTURE with acid(s), water and not more than 5% peroxyacetic acid, STABILIZED      | 5.1   | 8                    | II            |

Table 7.2.6.3.2

| UN   | Proper shipping name  | Class | Subsidiary hazard(s) | Packing group |
|------|-----------------------|-------|----------------------|---------------|
| 1295 | TRICHLOROSILANE       | 4.3   | 3/8                  | I             |
| 1818 | SILICON TETRACHLORIDE | 8     | –                    | II            |
| 2189 | DICHLOROSILANE        | 2.3   | 2.1/8                | –             |

## Part 7 – Provisions concerning transport operations

Table 7.2.6.3.3

| UN   | Proper shipping name  | Class | Subsidiary hazard(s) | Packing group |
|------|---|-------|----------------------|---------------|
| 3391 | ORGANOMETALLIC SUBSTANCE, SOLID, PYROPHORIC                   | 4.2   |                      | I             |
| 3392 | ORGANOMETALLIC SUBSTANCE, LIQUID, PYROPHORIC                  | 4.2   |                      | I             |
| 3393 | ORGANOMETALLIC SUBSTANCE, SOLID, PYROPHORIC, WATER-REACTIVE   | 4.2   | 4.3                  | I             |
| 3394 | ORGANOMETALLIC SUBSTANCE, LIQUID, PYROPHORIC, WATER-REACTIVE  | 4.2   | 4.3                  | I             |
| 3395 | ORGANOMETALLIC SUBSTANCE, SOLID, WATER-REACTIVE               | 4.3   |                      | I, II, III    |
| 3396 | ORGANOMETALLIC SUBSTANCE, SOLID, WATER REACTIVE, FLAMMABLE    | 4.3   | 4.1                  | I, II, III    |
| 3397 | ORGANOMETALLIC SUBSTANCE, SOLID, WATER REACTIVE, SELF-HEATING | 4.3   | 4.2                  | I, II, III    |
| 3398 | ORGANOMETALLIC SUBSTANCE, LIQUID, WATER REACTIVE              | 4.3   |                      | I, II, III    |
| 3399 | ORGANOMETALLIC SUBSTANCE, LIQUID, WATER REACTIVE, FLAMMABLE   | 4.3   | 3                    | I, II, III    |
| 3400 | ORGANOMETALLIC SUBSTANCE, SOLID, SELF-HEATING                 | 4.2   |                      | II, III       |

Table 7.2.6.3.4

| UN*  | Proper shipping name   | Class | Subsidiary hazard(s) | Packing group |
|------|--|-------|----------------------|---------------|
| 1325 | FLAMMABLE SOLID, ORGANIC, N.O.S. with a technical name as listed in 2.5.3.2.4 under "exempt" | 4.1   | None                 | II, III       |
| 3101 | ORGANIC PEROXIDE TYPE B, LIQUID  | 5.2   | 1 and/or 8           | –             |
| 3102 | ORGANIC PEROXIDE TYPE B, SOLID   | 5.2   | 1 and/or 8           | –             |
| 3103 | ORGANIC PEROXIDE TYPE C, LIQUID  | 5.2   | None or 8            | –             |
| 3104 | ORGANIC PEROXIDE TYPE C, SOLID   | 5.2   | None or 8            | –             |
| 3105 | ORGANIC PEROXIDE TYPE D, LIQUID  | 5.2   | None or 8            | –             |
| 3106 | ORGANIC PEROXIDE TYPE D, SOLID   | 5.2   | None or 8            | –             |
| 3107 | ORGANIC PEROXIDE TYPE E, LIQUID  | 5.2   | None or 8            | –             |
| 3108 | ORGANIC PEROXIDE TYPE E, SOLID   | 5.2   | None or 8            | –             |
| 3109 | ORGANIC PEROXIDE TYPE F, LIQUID  | 5.2   | None or 8            | –             |
| 3110 | ORGANIC PEROXIDE TYPE F, SOLID   | 5.2   | None or 8            | –             |
| 3111 | ORGANIC PEROXIDE TYPE B, LIQUID, TEMPERATURE CONTROLLED                                      | 5.2   | 1 and/or 8           | –             |
| 3112 | ORGANIC PEROXIDE TYPE B, SOLID, TEMPERATURE CONTROLLED                                       | 5.2   | 1 and/or 8           | –             |
| 3113 | ORGANIC PEROXIDE TYPE C, LIQUID, TEMPERATURE CONTROLLED                                      | 5.2   | None or 8            | –             |
| 3114 | ORGANIC PEROXIDE TYPE C, SOLID, TEMPERATURE CONTROLLED                                       | 5.2   | None or 8            | –             |
| 3115 | ORGANIC PEROXIDE TYPE D, LIQUID, TEMPERATURE CONTROLLED                                      | 5.2   | None or 8            | –             |
| 3116 | ORGANIC PEROXIDE TYPE D, SOLID, TEMPERATURE CONTROLLED                                       | 5.2   | None or 8            | –             |
| 3117 | ORGANIC PEROXIDE TYPE E, LIQUID, TEMPERATURE CONTROLLED                                      | 5.2   | None or 8            | –             |

| UN*  | Proper shipping name                                    | Class | Subsidiary hazard(s) | Packing group |
|------|---|-------|----------------------|---------------|
| 3118 | ORGANIC PEROXIDE TYPE E, SOLID, TEMPERATURE CONTROLLED  | 5.2   | None or 8            | –             |
| 3119 | ORGANIC PEROXIDE TYPE F, LIQUID, TEMPERATURE CONTROLLED | 5.2   | None or 8            | –             |
| 3120 | ORGANIC PEROXIDE TYPE F, SOLID, TEMPERATURE CONTROLLED  | 5.2   | None or 8            | –             |

\* Except for substances with the technical name PEROXYACETIC ACID.

7.2.6.4 Notwithstanding table 7.2.6.3.4, due regard shall continue to be taken of the dangerous reactions specified in the provisions of 7.2.6.1.1 to 7.2.6.1.4.

7.2.6.5 Notwithstanding the provisions of 7.2.5, substances of class 8, packing group II or III, that would otherwise be required to be segregated from one another due to the provisions pertaining to segregation groups as identified by an entry in column 16b of the Dangerous Goods List indicating “away from” or “separated from” “acids” or “away from” or “separated from” “alkalis”, may be transported in the same cargo transport unit, whether in the same packaging or not, provided:

- .1 the substances comply with the provisions of 7.2.6.1;
- .2 the package does not contain more than 30 L for liquids or 30 kg for solids;
- .3 the transport document includes the statement required by 5.4.1.5.11.3; and
- .4 a copy of the test report that verifies that the substances do not react dangerously with each other shall be provided if requested by the competent authority.

## 7.2.7 Segregation of goods of class 1

### 7.2.7.1 Segregation between goods of class 1

7.2.7.1.1 Goods of class 1 may be stowed within the same compartment or hold, or closed cargo transport unit as indicated in 7.2.7.1.4. In other cases, they shall be stowed in separate compartments or holds, or closed cargo transport units.

7.2.7.1.2 When goods requiring different stowage arrangements are permitted by 7.2.7.1.4 to be transported in the same compartment or hold, or closed cargo transport unit, the appropriate stowage arrangement shall conform to the most stringent provisions for the entire load.

7.2.7.1.3 Where a mixed load of different divisions is transported within the same compartment or hold, or closed cargo transport unit, the entire load shall be treated as if belonging to the hazard division in the order 1.1 (most dangerous), 1.5, 1.2, 1.3, 1.6 and 1.4 (least dangerous) and the stowage arrangement shall conform to the most stringent provisions for the entire load.

#### 7.2.7.1.4 Permitted mixed stowage for goods of class 1

| Compatibility group | A | B | C              | D              | E              | F | G              | H | J | K | L              | N              | S              |
|---------------------|---|---|----------------|----------------|----------------|---|----------------|---|---|---|----------------|----------------|----------------|
| A                   | X |   |                |                |                |   |                |   |   |   |                |                |                |
| B                   |   | X |                |                |                |   |                |   |   |   |                |                | X              |
| C                   |   |   | X              | X <sup>6</sup> | X <sup>6</sup> |   | X <sup>1</sup> |   |   |   |                | X <sup>4</sup> | X              |
| D                   |   |   | X <sup>6</sup> | X              | X <sup>6</sup> |   | X <sup>1</sup> |   |   |   |                | X <sup>4</sup> | X              |
| E                   |   |   | X <sup>6</sup> | X <sup>6</sup> | X              |   | X <sup>1</sup> |   |   |   |                | X <sup>4</sup> | X              |
| F                   |   |   |                |                |                | X |                |   |   |   |                |                | X              |
| G                   |   |   | X <sup>1</sup> | X <sup>1</sup> | X <sup>1</sup> |   | X              |   |   |   |                |                | X              |
| H                   |   |   |                |                |                |   |                | X |   |   |                |                | X              |
| J                   |   |   |                |                |                |   |                |   | X |   |                |                | X              |
| K                   |   |   |                |                |                |   |                |   |   | X |                |                | X              |
| L                   |   |   |                |                |                |   |                |   |   |   | X <sup>2</sup> |                |                |
| N                   |   |   | X <sup>4</sup> | X <sup>4</sup> | X <sup>4</sup> |   |                |   |   |   |                | X <sup>3</sup> | X <sup>5</sup> |
| S                   |   | X | X              | X              | X              | X | X              | X | X | X |                | X <sup>5</sup> | X              |

“X” indicates that goods of the corresponding compatibility groups may be stowed in the same compartment, hold, or closed cargo transport unit.

Part 7 – Provisions concerning transport operations

**Notes**

- <sup>1</sup> Explosive articles in compatibility group G (other than fireworks) may be stowed with explosive articles of compatibility groups C, D and E provided no explosive substances are transported in the same compartment or hold, or closed cargo transport unit.
- <sup>2</sup> A consignment of one type in compatibility group L shall only be stowed with a consignment of the same type within compatibility group L.
- <sup>3</sup> Different types of articles of Division 1.6, compatibility group N, may only be transported together when it is proven that there is no additional risk of sympathetic detonation between the articles. Otherwise they shall be treated as division 1.1.
- <sup>4</sup> When articles of compatibility group N are transported with articles or substances of compatibility groups C, D or E, the goods of compatibility group N shall be treated as compatibility group D.
- <sup>5</sup> When articles of compatibility group N are transported together with articles or substances of compatibility group S, the entire load shall be treated as compatibility group N.
- <sup>6</sup> Any combination of articles in compatibility groups C, D and E shall be treated as compatibility group E. Any combination of substances in compatibility groups C and D shall be treated as the most appropriate compatibility group shown in 2.1.2.3, taking into account the predominant characteristics of the combined load. This overall classification code shall be displayed on any label or placard placed on a unit load or closed cargo transport unit as prescribed in 5.2.2.2.2.

**7.2.7.1.5** Closed cargo transport units carrying different goods of class 1 do not require segregation from each other provided 7.2.7.1.4 authorizes the goods to be transported together. Where this is not permitted, closed cargo transport unit shall be “separated from” one another.

**7.2.7.2 Segregation from goods of other classes**

**7.2.7.2.1** Notwithstanding the segregation provisions of this chapter, AMMONIUM NITRATE (UN 1942), AMMONIUM NITRATE BASED FERTILIZER (UN 2067), alkali metal nitrates (e.g. UN 1486) and alkaline earth metal nitrates (e.g. UN 1454) may be stowed together with blasting explosives (except EXPLOSIVE, BLASTING, TYPE C, UN 0083) provided the aggregate is treated as blasting explosives under class 1.

**Note:** Alkali metal nitrates include caesium nitrate (UN 1451), lithium nitrate (UN 2722), potassium nitrate (UN 1486), rubidium nitrate (UN 1477) and sodium nitrate (UN 1498). Alkaline earth metal nitrates include barium nitrate (UN 1446), beryllium nitrate (UN 2464), calcium nitrate (UN 1454), magnesium nitrate (UN 1474) and strontium nitrate (UN 1507).

**7.2.8 Segregation codes**

The segregation codes given in column 16b of the Dangerous Goods List are as specified below:

| Segregation code | Description  |
|------------------|--|
| SG1              | For packages carrying a subsidiary hazard label of class 1, segregation as for class 1, division 1.3. However, in relation to goods of class 1, segregation as for the primary hazard. |
| SG2              | Segregation as for class 1.2G.   |
| SG3              | Segregation as for class 1.3G.   |
| SG4              | Segregation as for class 2.1.  |
| SG5              | Segregation as for class 3.  |
| SG6              | Segregation as for class 5.1.  |
| SG7              | Stow “away from” class 3.  |
| SG8              | Stow “away from” class 4.1.  |
| SG9              | Stow “away from” class 4.3.  |
| SG10             | Stow “away from” class 5.1.  |
| SG11             | Stow “away from” class 6.2.  |
| SG12             | Stow “away from” class 7.  |
| SG13             | Stow “away from” class 8.  |
| SG14             | Stow “separated from” class 1 except for division 1.4S.  |
| SG15             | Stow “separated from” class 3.   |
| SG16             | Stow “separated from” class 4.1.   |
| SG17             | Stow “separated from” class 5.1.   |
| SG18             | Stow “separated from” class 6.2.   |
| SG19             | Stow “separated from” class 7.   |
| SG20             | Stow “away from” SGG1 – acids.   |
| SG21             | Stow “away from” SGG18 – alkalis.  |

## Chapter 7.2 – General segregation provisions

| Segregation code | Description   |
|------------------|---|
| SG22             | Stow “away from” ammonium salts.  |
| SG23             | Stow “away from” animal or vegetable oils.  |
| SG24             | Stow “away from” SGG17 – azides.  |
| SG25             | Stow “separated from” goods of classes 2.1 and 3.   |
| SG26             | In addition: from goods of classes 2.1 and 3 when stowed on deck of a containership a minimum distance of two container spaces athwartship shall be maintained, when stowed on ro-ro ships a distance of 6 m athwartship shall be maintained. |
| SG27             | Stow “separated from” explosives containing chlorates or perchlorates.  |
| SG28             | Stow “separated from” SGG2 – ammonium compounds and explosives containing ammonium compounds or salts.  |
| SG29             | Segregation from foodstuffs as in 7.3.4.2.2, 7.6.3.1.2 or 7.7.3.7.  |
| SG30             | Stow “away from” SGG7 – heavy metals and their salts.   |
| SG31             | Stow “away from” SGG9 – lead and its compounds.   |
| SG32             | Stow “away from” SGG10 – liquid halogenated hydrocarbons.   |
| SG33             | Stow “away from” SGG15 – powdered metals.   |
| SG34             | When containing ammonium compounds, “separated from” SGG4 – chlorates or SGG13 – perchlorates and explosives containing chlorates or perchlorates.  |
| SG35             | Stow “separated from” SGG1 – acids.   |
| SG36             | Stow “separated from” SGG18 – alkalis.  |
| SG37             | Stow “separated from” ammonia.  |
| SG38             | Stow “separated from” SGG2 – ammonium compounds.  |
| SG39             | Stow “separated from” SGG2 – ammonium compounds other than AMMONIUM PERSULPHATE (UN 1444).  |
| SG40             | Stow “separated from” SGG2 – ammonium compounds other than mixtures of ammonium persulphates and/or potassium persulphates and/or sodium persulphates.  |
| SG41             | Stow “separated from” animal or vegetable oil.  |
| SG42             | Stow “separated from” SGG3 – bromates.  |
| SG43             | Stow “separated from” bromine.  |
| SG44             | Stow “separated from” CARBON TETRACHLORIDE (UN 1846).   |
| SG45             | Stow “separated from” SGG4 – chlorates.   |
| SG46             | Stow “separated from” chlorine.   |
| SG47             | Stow “separated from” SGG5 – chlorites.   |
| SG48             | Stow “separated from” combustible material (particularly liquids).  |
| SG49             | Stow “separated from” SGG6 – cyanides.  |
| SG50             | Segregation from foodstuffs as in 7.3.4.2.1, 7.6.3.1.2 or 7.7.3.6.  |
| SG51             | Stow “separated from” SGG8 – hypochlorites.   |
| SG52             | Stow “separated from” iron oxide.   |
| SG53             | Shall not be stowed together with combustible material in the same cargo transport unit.  |
| SG54             | Stow “separated from” SGG11 – mercury and mercury compounds.  |
| SG55             | Stow “separated from” mercury salts.  |
| SG56             | Stow “separated from” SGG12 – nitrites.   |
| SG57             | Stow “separated from” odour-absorbing cargoes.  |
| SG58             | Stow “separated from” SGG13 – perchlorates.   |
| SG59             | Stow “separated from” SGG14 – permanganates.  |
| SG60             | Stow “separated from” SGG16 – peroxides.  |
| SG61             | Stow “separated from” SGG15 – powdered metals.  |
| SG62             | Stow “separated from” sulphur.  |



## Part 7 – Provisions concerning transport operations

| Segregation code | Description  |
|------------------|--|
| SG63             | Stow “separated longitudinally by an intervening complete compartment or hold from” class 1.   |
| SG64             | [Reserved]   |
| SG65             | Stow “separated by a complete compartment or hold from” class 1 except for division 1.4.   |
| SG66             | [Reserved]   |
| SG67             | Stow “separated from” division 1.4 and “separated longitudinally by an intervening complete compartment or hold from” divisions 1.1, 1.2, 1.3, 1.5 and 1.6 except from explosives of compatibility group J.  |
| SG68             | If flashpoint 60°C c.c. or below, segregation as for class 3 but “away from” class 4.1.  |
| SG69             | For AEROSOLS with a maximum capacity of 1 L: segregation as for class 9.<br>Stow “separated from” class 1 except for division 1.4.<br>For AEROSOLS with a capacity above 1 L: segregation as for the appropriate subdivision of class 2.<br>For WASTE AEROSOLS: segregation as for the appropriate subdivision of class 2. |
| SG70             | For arsenic sulphides, “separated from” SGG1 – acids.  |
| SG71             | Within the appliance, to the extent that the dangerous goods are integral parts of the complete life-saving appliance, there is no need to apply the provisions on segregation of substances in chapter 7.2.   |
| SG72             | See tables in 7.2.6.3.   |
| SG73             | [Reserved]   |
| SG74             | Segregation as for 1.4G.   |
| SG76             | Segregation as for class 7.  |
| SG77             | Segregation as for class 8. However, in relation to class 7, no segregation needs to be applied.   |
| SG78             | Stow “separated longitudinally by an intervening complete compartment or hold from” division 1.1, 1.2, and 1.5.  |

Annex  
Segregation flow chart

The use of this chart is not mandatory and is provided for information purposes only.

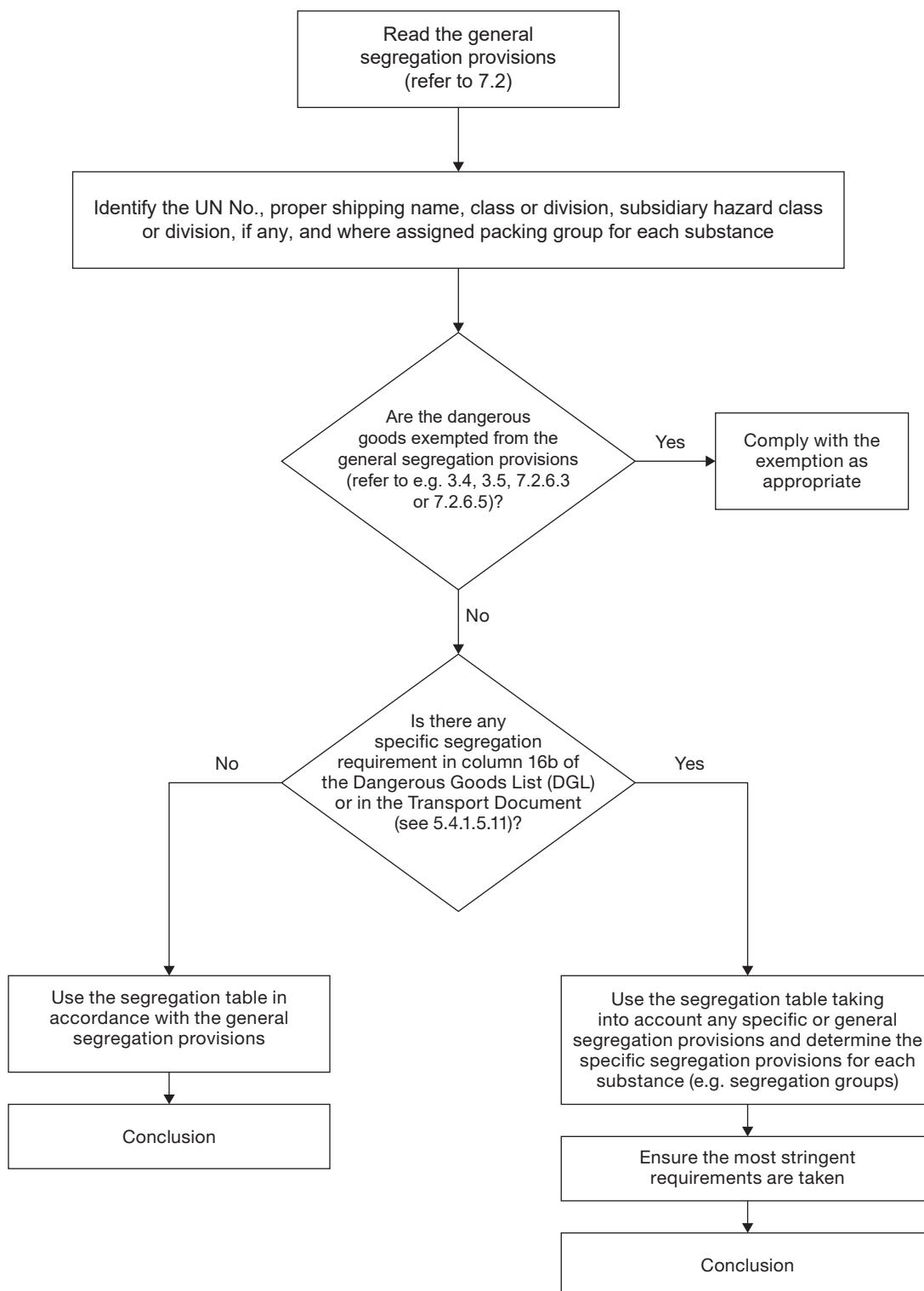

## Part 7 – Provisions concerning transport operations

### Examples

The following examples only illustrate the process of segregation. Subsequent additional provisions of this Code may apply (e.g. 7.3.4).

- 1 Segregation of 300 kg of celluloid, scrap (UN 2002) in one drum and 200 L of epibromohydrin (UN 2558) in one drum.
  - .1 According to the Dangerous Goods List, UN 2002 is class 4.2, PG III, and UN 2558 is class 6.1, PG I and has a subsidiary hazard of class 3.
  - .2 Neither are exempted by 3.4, 3.5, 7.2.6.3 or 7.2.6.5.
  - .3 There are no specific segregation requirements for these substances in column 16b of the Dangerous Goods List.
  - .4 According to the segregation table given in 7.2.4 for classes 4.2 and 6.1, the intersecting box shows number 1, whereas for classes 4.2 and 3, the intersecting box shows a number 2. The value 2 is the more stringent, therefore the substances are required to be “separated from” one another.
- 2 Segregation of 50 kg of potassium perchlorate (UN 1489) in one drum and 50 kg of nickel cyanide (UN 1653) in one drum.
  - .1 According to the Dangerous Goods List, UN 1489 is class 5.1, PG II and UN 1653 is class 6.1, PG II.
  - .2 Neither are exempted by 3.4, 3.5, 7.2.6.3 or 7.2.6.5.
  - .3 For UN 1489, column 16b of the Dangerous Goods List states “SG38” (“separated from” ammonium compounds other than AMMONIUM PERSULPHATE (UN 1444)) and “SG49” (“separated from” cyanides).
  - .4 For UN 1653, column 16b of the Dangerous Goods List states “SG35” (“separated from” acids).
  - .5 According to the segregation table given in 7.2.4 for classes 5.1 and 6.1, the intersecting box shows an “1”.
  - .6 According to the segregation groups in section 3.1.4, UN 1653 is listed in group 6 (cyanides).
  - .7 Therefore, the substances are required to be “separated from” one another.
- 3 Segregation of 10 kg of acetone (UN 1090) in one box and 20 kg of ethyldichlorosilane (UN 1183) in another box.
  - .1 According to the Dangerous Goods List, UN 1090 is class 3, PG II.
  - .2 According to the Dangerous Goods List, UN 1183 is class 4.3, PG I and has subsidiary hazards of classes 3 and 8.
  - .3 Neither are exempted by 3.4, 3.5, 7.2.6.3 or 7.2.6.5.
  - .4 UN 1090 has no specific segregation requirements in column 16b.
  - .5 For UN 1183, column 16b of the Dangerous Goods List states “SG5” (segregation as for class 3), “SG8” (“away from” class 4.1), “SG13” (“away from” class 8), “SG25” (“separated from” goods of classes 2.1 and 3) and “SG26” (in addition: from goods of classes 2.1 and 3 when stowed on deck of a containership a minimum distance of two container spaces athwartship shall be maintained, when stowed on ro-ro ships a distance of 6 m athwartship shall be maintained).
  - .6 According to the segregation table given in 7.2.4, the intersecting box shows an “X” for classes 3 and 3, but as UN 1183 is required to be “separated from” class 3, the substances are required to be “separated from” one another. In addition, when these substances are stowed on deck of a containership a minimum distance of two container spaces athwartship shall be maintained, and when they are stowed on ro-ro ships a distance of 6 m athwartship shall be maintained.
- 4 Segregation of 10 kg of adhesives (UN 1133, PG III) in limited quantities and 40 kg of beryllium nitrate (UN 2464) in the same freight container.
  - .1 According to the Dangerous Goods List, UN 1133 is class 3, PG III.
  - .2 According to the Dangerous Goods List, UN 2464 is class 5.1, PG II and has a subsidiary hazard of class 6.1.
  - .3 According to section 3.4, UN 1133 in limited quantities is exempted from the segregation provisions of part 7.
  - .4 Therefore, no segregation requirements shall apply.

## Chapter 7.3

---

### *Consigning operations concerning the packing and use of cargo transport units (CTUs) and related provisions*

#### 7.3.1 Introduction

This chapter contains the provisions appropriate to those responsible for the consignment operations in the dangerous goods transport supply chain, including provisions relating to packing of dangerous goods into cargo transport units.

#### 7.3.2 General provisions for cargo transport units

7.3.2.1 Packages containing dangerous goods shall only be loaded in cargo transport units that are strong enough to withstand the shocks and loadings normally encountered during transport, having regard to the conditions to be expected during the anticipated journey. The cargo transport unit shall be constructed in such a way as to prevent the loss of contents. Where appropriate, the cargo transport unit shall be fitted with devices to facilitate securing and handling of the dangerous goods. The cargo transport units shall be adequately maintained.

7.3.2.2 Unless otherwise specified, the applicable provisions of the *International Convention for Safe Containers, 1972* (CSC Convention), as amended, shall be followed for the use of any cargo transport unit which meets the definition of a “container” within the terms of that Convention.

7.3.2.3 The *International Convention for Safe Containers, 1972* (CSC Convention) does not apply to offshore containers that are handled in open seas. The design and testing of offshore containers shall take into account the dynamic lifting and impact forces that may occur when a container is handled in open seas in adverse weather and sea conditions. The requirements for such containers shall be determined by the approving competent authority. Such provisions should be based on the *Guidelines for the approval of offshore containers handled in open seas* (MSC/Circ.860). Such containers shall be clearly marked with the words “OFFSHORE CONTAINER” on the safety approval plate.

#### 7.3.3 Packing of cargo transport units\*

7.3.3.1 Prior to the use of a cargo transport unit it shall be checked to ensure that it is apparently fit for its intended purpose.†

7.3.3.2 The interior and exterior of a cargo transport unit shall be inspected prior to loading to ensure that there is no damage that could affect its integrity or that of the packages to be loaded in it.

7.3.3.3 Packages shall be examined and any found to be damaged, leaking or sifting shall not be packed into a cargo transport unit. Care shall be taken to see that excessive water, snow, ice or foreign matter adhering to packages is removed before packing into a cargo transport unit. Whenever the handling provision “keep as dry as reasonably practicable” (H1) is assigned in column 16a of the Dangerous Goods List, the cargo transport unit including any contained goods, securing or packing materials shall be kept as dry as reasonably practicable.

7.3.3.4 Drums containing dangerous goods shall always be stowed in an upright position unless otherwise authorized by the competent authority.

7.3.3.5 Cargo transport units shall be loaded in accordance with 7.3.4, so that incompatible dangerous or other goods are segregated. Specific loading instructions such as orientation arrows, not to be double stacked, keep dry or temperature control requirements shall be met. Liquid dangerous goods shall be loaded below dry dangerous goods whenever possible.

\* See CTU Code.

† For safety approval plates and maintenance and examination of containers see *International Convention for Safe Containers, 1972* (CSC Convention), as amended, annex I, regulations 1 and 2 (see 1.1.2.3).

**Part 7 – Provisions concerning transport operations**

- 7.3.3.6** Packages containing dangerous goods and unpackaged dangerous articles shall be secured by suitable means capable of restraining the goods (such as fastening straps, sliding slatboards, adjustable brackets) in the cargo transport unit in a manner that will prevent any movement during transport which would change the orientation of the packages or cause them to be damaged. When dangerous goods are transported with other goods (e.g. heavy machinery or crates), all goods shall be securely fixed or packed in the cargo transport units so as to prevent the release of dangerous goods. Movement of packages may also be prevented by filling any voids by the use of dunnage or by blocking and bracing. Where restraints such as banding or straps are used, these shall not be over-tightened to cause damage or deformation of the package or the securing points (such as D-rings) within the cargo transport unit. The packages shall be packed in such a way that there will be a minimum likelihood of damage to fittings during transport. Such fittings on packages shall be adequately protected. Where restraints such as banding or straps with integral container fittings are used, care should be taken to ensure that the Maximum Securing Load (*MSL*) of the fittings is not exceeded.
- 7.3.3.7** Packages shall not be stacked unless designed for that purpose. Where packages of different stacking designs are to be loaded together, consideration shall be given to their compatibility for stacking with each other. Where necessary, stacked packages shall be prevented from damaging the package below by the use of load bearing devices.
- 7.3.3.8** Cargo shall be entirely contained within the cargo transport unit without overhang or projections. Oversized machinery (such as tractors and vehicles) may overhang or project outside of the cargo transport unit provided that the dangerous goods integral to the machinery cannot leak or spill outside of the cargo transport unit.
- 7.3.3.9** During loading and unloading, packages containing dangerous goods shall be protected from being damaged. Particular attention shall be paid to the handling of packages during their preparation for transport, the type of cargo transport unit to be used for their carriage and to the method of loading or unloading, so that accidental damage is not caused through dragging or mishandling. Packages that appear to be leaking or damaged so that the contents may escape shall not be accepted for transport. If a package is found to be damaged so that the contents leak, the damaged package shall not be transported but moved to a safe place in accordance with instructions given by a competent authority or a designated responsible person who is familiar with the dangerous goods, the risks involved and the measures that should be taken in an emergency.
- Note 1:** Additional operational requirements for the transport of packagings and IBCs are provided in the special packing provisions for packagings and IBCs (see chapter 4.1).
- 7.3.3.10** When a dangerous goods consignment forms only part of the load of a cargo transport unit, it should, whenever possible, be packed adjacent to the doors with marks and labels visible, so as to be accessible in the event of an emergency or to facilitate inspection.
- 7.3.3.11** If the doors of a cargo transport unit are locked, the means of locking shall be such that, in cases of emergency, the doors can be opened without delay.
- 7.3.3.12** When venting is required, venting devices shall be kept clear and operable.
- 7.3.3.13** Cargo transport units containing dangerous goods shall be marked and placarded according to chapter 5.3. Irrelevant marks, labels, placards, orange panels, signs and marine pollutant marks shall be removed, masked or otherwise obliterated before packing a cargo transport unit.
- △ **7.3.3.14** Cargo transport units shall be packed so that the cargo is uniformly distributed.\*
- 7.3.3.15** If goods of class 1 are packed, the cargo transport unit shall comply with the definition in 7.1.2 for closed cargo transport unit for class 1.
- 7.3.3.16** If goods of class 7 are packed, the transport index and, if applicable, the criticality safety index, shall be limited according to 7.1.4.5.3.
- 7.3.3.17** Those responsible for the packing of dangerous goods into a cargo transport unit shall provide a “container/vehicle packing certificate” (see 5.4.2). This document is not required for tanks.
- 7.3.3.18** Flexible bulk containers are not allowed to be transported in cargo transport units (see 4.3.4).

**7.3.4 Segregation provisions within cargo transport units**

- 7.3.4.1** Dangerous goods which have to be segregated from each other according to the provisions in chapter 7.2 shall not be transported in the same cargo transport unit with the exception of dangerous goods which shall be segregated “away from” each other which may be transported in the same cargo transport unit with the approval of the competent authority. In such cases an equivalent standard of safety shall be maintained.

\* Refer to the CTU Code.

#### 7.3.4.2 Segregation in relation to foodstuffs

7.3.4.2.1 Dangerous goods having a primary or subsidiary hazard of classes 2.3, 6.1, 6.2, 7 (with the exception of UN 2908, 2909, 2910 and 2911), 8 and dangerous goods for which it is referred to in segregation code SG29 or SG50 in column 16b of the Dangerous Goods List shall not be transported together with foodstuffs (see 1.2.1) in the same cargo transport unit.

7.3.4.2.2 Notwithstanding the provisions in 7.3.4.2.1, the following dangerous goods may be transported with foodstuffs provided that they are not loaded within 3 m from foodstuffs:

- .1 dangerous goods of packing group III of classes 6.1 and 8;
- .2 dangerous goods of packing group II of class 8; and
- .3 any other dangerous goods of packing group III with a subsidiary hazard of classes 6.1 or 8; and
- .4 dangerous goods having a reference to 7.3.4.2.2 in column 16b of the Dangerous Goods List.

#### 7.3.5 Tracking and monitoring equipment

When security devices, beacons or other tracking or monitoring equipment are used, they shall be securely installed to the cargo transport unit and shall be of a certified safe type\* for the dangerous goods that will be carried within the cargo transport unit.

#### 7.3.6 Opening and unloading cargo transport units

7.3.6.1 Cargo transport units shall be approached with caution. Before opening the doors, the nature of the contents and the possibility that leakages may have caused an unsafe condition, concentration of toxic or flammable vapours, or an oxygen-enriched or oxygen-depleted atmosphere, shall be considered.

7.3.6.2 After a cargo transport unit carrying dangerous goods has been unpacked or unloaded, precautions shall be taken to ensure that there is no contamination likely to make the cargo transport unit dangerous.

7.3.6.3 After unpacking or unloading corrosive substances, particular attention shall be paid to cleaning, as residues may be highly corrosive to the metal structures.

7.3.6.4 When the cargo transport unit offers no further hazard, the dangerous goods placards and other marks related to dangerous goods shall be removed, masked or otherwise obliterated.

#### 7.3.7 Cargo transport units under temperature control

##### 7.3.7.1 Preamble

7.3.7.1.1 If the temperature of certain substances (such as organic peroxides and polymerizing or self-reactive substances) exceeds a value which is typical of the substance as packaged for transport, a self-accelerating decomposition or polymerization possibly of explosive violence, may result. To prevent such decomposition or polymerization, it is necessary to control the temperature of such substances during transport. Other substances not requiring temperature control for safety reasons may be transported under controlled temperature conditions for commercial reasons.

7.3.7.1.2 The provisions for the temperature control of certain specified substances are based on the assumption that the temperature in the immediate surroundings of the cargo does not exceed 55°C during transport and attains this value for a relatively short time only during each period of 24 h.

\* Refer to the Recommendations published by the International Electrotechnical Commission, in particular, to publication IEC 60079.

**Part 7 – Provisions concerning transport operations**

**7.3.7.2 General provisions**

**7.3.7.2.1** Where a number of packages containing self-reactive substances, organic peroxides and polymerizing substances are loaded in a closed cargo transport unit, the total quantity of substance, the type and number of packages and the stacking arrangement shall not create an explosion hazard.

**7.3.7.2.2** These provisions apply to certain self-reactive substances when required by 2.4.2.3.4, and certain organic peroxides when required by 2.5.3.4.1 and certain polymerizing substances when required by 2.4.2.5.2 or special provision 386 of chapter 3.3 which may only be transported under conditions where the temperature is controlled.

**7.3.7.2.3** These provisions also apply to the transport of substances for which:

- .1 the proper shipping name as indicated in column 2 of the Dangerous Goods List of chapter 3.2 or according to 3.1.2.6 contains the words “TEMPERATURE CONTROLLED”; and
- .2 the self-accelerating decomposition temperature (SADT) or the self-accelerating polymerization temperature (SAPT) determined for the substance (with or without chemical stabilization) as offered for transport is:
  - .1 50°C or less for single packagings and IBCs; or
  - .2 45°C or less for portable tanks.

When chemical inhibition is not used to stabilize a reactive substance which may generate dangerous amounts of heat and gas, or vapour, under normal transport conditions, these substances need to be transported under temperature control. These provisions do not apply to substances which are stabilized by the addition of chemical inhibitors such that the SADT or the SAPT is greater than that prescribed in paragraphs 7.3.7.2.3.2.1 or 7.3.7.2.3.2.2.

**7.3.7.2.4** In addition, if a self-reactive substance or organic peroxide or a substance the proper shipping name of which contains the word “STABILIZED” and which is not normally required to be transported under temperature control is transported under conditions where the temperature may exceed 55°C, it may require temperature control.

**7.3.7.2.5** The “control temperature” is the maximum temperature at which the substance can be safely transported. In the event of loss of temperature control, it may be necessary to implement emergency procedures. The “emergency temperature” is the temperature at which such procedures shall be implemented.

**7.3.7.2.6 Derivation of control and emergency temperatures**

| Type of receptacle        | SADT <sup>a</sup> /SAPT <sup>a</sup>           | Control temperature  | Emergency temperature   |
|---------------------------|--|--|---|
| Single packagings and IBC | 20°C or less<br>over 20°C to 35°C<br>over 35°C | 20°C below SADT/SAPT<br>15°C below SADT/SAPT<br>10°C below SADT/SAPT | 10°C below SADT/SAPT<br>10°C below SADT/SAPT<br>5°C below SADT/SAPT |
| Portable tanks            | ≤ 45°C   | 10°C below SADT/SAPT   | 5°C below SADT/SAPT   |

<sup>a</sup> i.e. the SADT/SAPT of the substance as packed for transport.

**7.3.7.2.7** The control and emergency temperatures are derived using the table in 7.3.7.2.6 from the self-accelerating decomposition temperature (SADT) or from the self-accelerating polymerization temperature (SAPT) which are defined as the lowest temperatures at which self-accelerating decomposition or self-accelerating polymerization may occur with a substance in the packaging, IBC or portable tank as used in transport. An SADT or SAPT shall be determined in order to decide if a substance shall be subjected to temperature control during transport. Provisions for the determination of the SADT and SAPT are given in 2.4.2.3.4, 2.5.3.4.2 and 2.4.2.5.2 for self-reactive substances, organic peroxides and polymerizing substances and mixtures, respectively.

**7.3.7.2.8** Control and emergency temperatures, where appropriate, are provided for currently assigned self-reactive substances in 2.4.2.3.2.3 and for currently assigned organic peroxide formulations in 2.5.3.2.4.

**7.3.7.2.9** The actual transport temperature may be lower than the control temperature but shall be selected so as to avoid dangerous separation of phases.

**7.3.7.3 Transport under temperature control**

**7.3.7.3.1** Prior to the use of cargo transport unit, the refrigeration system shall be subjected to a thorough inspection and a test to ensure that all parts are functioning properly.

**7.3.7.3.2** Refrigerant gas shall only be replaced in accordance with the manufacturer’s operating instructions for the refrigeration system. Prior to filling replacement refrigerant gas, a certificate of analysis from the supplier shall be obtained and checked to confirm that the gas meets refrigeration system specifications. In addition,



## Chapter 7.3 – Consigning operations concerning the packing and use of CTUs

if concerns about the integrity of the supplier and/or the refrigerant gas supply chain give rise to suspicion of contamination of the gas, the replacement refrigerant gas shall be checked for possible contamination prior to use. If the refrigerant gas is found to be contaminated, it shall not be used, the cylinder shall be plainly marked "CONTAMINATED", the cylinder shall be sealed and sent for recycling or disposal, and notification shall be given to the refrigerant gas supplier and authorized distributor and competent authority(ies) of the countries in which the supplier and distributor reside, as appropriate. The date of last refrigerant replacement shall be included in the maintenance record of the refrigeration system.

**Note:** Contamination can be checked by using flame halide lamp tests, gas sniffer tube tests or gas chromatography. Replacement refrigerant gas cylinders may be marked with the test result and the date of testing.

- 7.3.7.3.3 When a cargo transport unit is to be filled with packages containing substances having different control temperatures, all packages shall be pre-cooled to avoid exceeding the lowest control temperature.
- 7.3.7.3.3.1 In the event that non-temperature-controlled substances are transported in the same cargo transport unit as temperature controlled substances, the package(s) containing substances that require refrigeration shall be stowed in such a way as to be readily accessible from the door(s) of the cargo transport unit.
- 7.3.7.3.3.2 If substances with different control temperatures are loaded in the cargo transport unit, the substances with the lowest control temperature shall be stowed in the most readily accessible position from the doors of the cargo transport unit.
- 7.3.7.3.3.3 The door(s) shall be capable of being opened readily in case of emergency so that the package(s) can be removed. The carrier shall be informed about the location of the different substances within the unit. The cargo shall be secured to prevent packages from falling when the door(s) is (are) opened. The packages shall be securely stowed so as to allow for adequate air circulation throughout the cargo.
- 7.3.7.3.4 The master shall be provided with operating instructions for the refrigeration system, procedures to be followed in the event of loss of control and instructions for regular monitoring of operating temperatures. Spare parts shall be carried for the systems described in 7.3.7.4.2.3, 7.3.7.4.2.4 and 7.3.7.4.2.5 so that they are available for emergency use should the refrigeration system malfunction during transport.
- 7.3.7.3.5 In cases where it may not be possible to carry specific substances according to the general provisions, full details of the proposed method of shipment shall be submitted to the competent authority concerned for approval.
- 7.3.7.4 **Methods of temperature control**
- 7.3.7.4.1 The suitability of a particular means of temperature control for transport depends on a number of factors. Among those to be considered are:
- .1 the control temperature(s) of the substance(s) to be transported;
  - .2 the difference between the control temperature and the anticipated ambient temperature conditions;
  - .3 the effectiveness of the thermal insulation of the cargo transport unit. The overall heat transfer coefficient shall not be more than 0.4 W/(m<sup>2</sup>·K) for cargo transport units and 0.6 W/(m<sup>2</sup>·K) for tanks; and
  - .4 the duration of the voyage.
- 7.3.7.4.2 Suitable methods for preventing the control temperature being exceeded are, in order of increasing capability:
- .1 thermal insulation, provided that the initial temperature of the substance is sufficiently below the control temperature;
  - .2 thermal insulation with a cooling method, provided that:
    - an adequate quantity of non-flammable coolant (such as liquid nitrogen or solid carbon dioxide), allowing a reasonable margin for delay, is carried;
    - liquid oxygen or air is not used as a coolant;
    - there is a uniform cooling effect even when most of the coolant has been consumed; and
    - the need to ventilate the cargo transport unit before entering is clearly indicated by a warning on the door(s) (see 5.5.3);
  - .3 single mechanical refrigeration, provided that the unit is thermally insulated and, for substances with a flashpoint lower than the sum of the emergency temperature plus 5°C, explosion proof electrical fittings are used within the cooling compartment to prevent ignition of flammable vapours from the substances;

**Part 7 – Provisions concerning transport operations**

- .4 combined mechanical refrigeration system and cooling method, provided that:
    - the two systems are independent of one another; and
    - the provisions of 7.3.7.4.2.2 and 7.3.7.4.2.3 are met;
  - .5 dual mechanical refrigeration system, provided that:
    - apart from the integral power supply unit, the two systems are independent of one another;
    - each system alone is capable of maintaining adequate temperature control; and
    - for substances with a flashpoint lower than the sum of the emergency temperature plus 5°C, explosion proof electrical fittings are used within the coolant compartment to prevent ignition of flammable vapours from the substances.
- 7.3.7.4.3** The refrigeration equipment and its controls shall be readily and safely accessible and all electrical connections weatherproof. Inside the cargo transport unit, the temperature shall be measured continuously. The measurement shall be taken in the air space of the unit, using two measuring devices independent of each other. The type and place of the measuring devices shall be selected so that their results are representative of the actual temperature in the cargo. At least one of the two measurements shall be recorded in such a manner that temperature changes are easily detectable. The temperature shall be checked every four to six hours and logged.
- 7.3.7.4.4** If substances are transported with a control temperature less than +25°C, the cargo transport unit shall be equipped with a visible and audible alarm effectively set at no higher than the control temperature. The alarms shall work independently from the power supply of the refrigeration system.
- 7.3.7.4.5** If an electrical supply is necessary for the cargo transport unit to operate the refrigeration or heating equipment, it shall be ensured that the correct connecting plugs are fitted. For under deck stowage, plugs shall, as a minimum, be of an IP 55 enclosure in accordance with IEC Publication 60529, with the specification for electrical equipment of temperature class T4 and explosion group IIB. However, when stowed on deck, these plugs shall be of an IP 56 enclosure in accordance with IEC Publication 60529.
- 7.3.7.5 Special provisions for self-reactive substances, organic peroxides and polymerizing substances**
- 7.3.7.5.1** For self-reactive substances (class 4.1) identified by UN Nos. 3231 and 3232 and organic peroxides (class 5.2) identified by UN Nos. 3111 and 3112, one of the following methods of temperature control described in 7.3.7.4.2 shall be used:
- .1 the methods referred to under 7.3.7.4.2.4 or 7.3.7.4.2.5; or
  - .2 the method referred to under 7.3.7.4.2.3 when the maximum ambient temperature to be expected during transport is at least 10°C below the control temperature.
- 7.3.7.5.2** For self-reactive substances (class 4.1) identified by UN Nos. 3233 to 3240, organic peroxides (class 5.2) identified by UN Nos. 3113 to 3120 and polymerizing substances identified by UN Nos. 3533 and 3534 or for those substances where the words “TEMPERATURE CONTROLLED” are added as part of the proper shipping name in accordance with 3.1.2.6.2, one of the following methods shall be used:
- .1 the methods referred to under 7.3.7.4.2.4 or 7.3.7.4.2.5;
  - .2 the method referred to under 7.3.7.4.2.3 when the maximum ambient temperature to be expected during transport does not exceed the control temperature by more than 10°C; or
  - .3 for short international voyages only (see 1.2.1), the methods referred to under 7.3.7.4.2.1 and 7.3.7.4.2.2 when the maximum ambient temperature to be expected during transport is at least 10°C below the control temperature.
- 7.3.7.6 Special provisions for flammable gases or liquids having a flashpoint less than 23°C c.c. transported under temperature control**
- 7.3.7.6.1** When flammable gases or liquids having a flashpoint less than 23°C c.c. are packed or loaded in a cargo transport unit equipped with a refrigerating or heating system, the cooling or heating equipment shall comply with 7.3.7.4.
- 7.3.7.6.2** When flammable liquids having a flashpoint less than 23°C c.c. and not requiring temperature control for safety reasons are transported under temperature control conditions for commercial reasons, explosion proof electrical fittings are required except when the substances are pre-cooled to and transported at a control temperature of at least 10°C below the flashpoint. In case of failure of a non-explosion proof refrigerating system, the system shall be disconnected from the power supply. It shall not be reconnected if the temperature has risen to a temperature less than 10°C below the flashpoint.
- 7.3.7.6.3** When flammable gases not requiring temperature control for safety reasons are transported under temperature control conditions for commercial reasons, explosion proof electrical fittings are required.

**7.3.7.7 Special provisions for vehicles transported on ships**

Insulated, refrigerated and mechanically refrigerated vehicles shall conform to the provisions of 7.3.7.4 and 7.3.7.5 as appropriate. In addition, the refrigerating appliance of a mechanically refrigerated vehicle shall be capable of operating independently of the engine used to propel the vehicle.

**7.3.7.8 Approval**

The competent authority may approve that less stringent means of temperature control may be used or that artificial refrigeration may be dispensed with under conditions of transport such as short international voyages or low ambient temperatures.

**7.3.8 Loading of cargo transport units on board ships**

Before loading, cargo transport units used for the transport of dangerous goods shall be examined for external signs of damage, leakage or sifting of contents. Any cargo transport unit found to be damaged, leaking or sifting shall not be loaded on to a ship until repairs have been effected or damaged packages have been removed.

## Chapter 7.4

### *Stowage and segregation on containerships*

**Note:** To facilitate familiarization with these requirements and to support training of relevant personnel, illustrations applicable to the segregation requirements on containerships are given in MSC.1/Circ.1440.

#### 7.4.1 Introduction

7.4.1.1 The provisions of this chapter apply to the stowage and segregation of containers which meet the definition of a container within the terms of the *International Convention for Safe Containers, 1972* (CSC Convention), as amended, which are transported on deck and in the cargo holds of containerships or on deck and in the cargo holds of other types of ships provided that these stowage positions are properly fitted to give a permanent stowage of containers during transport.

7.4.1.2 For ships carrying containers in conventional cargo spaces not properly fitted for the permanent stowage of containers the provisions of chapter 7.6 apply.

7.4.1.3 For stowage of FISH MEAL, UNSTABILIZED (UN 1374), FISH MEAL, STABILIZED (UN 2216) and KRILL MEAL (UN 3497) in containers, the provisions of 7.6.2.7.2.2 also apply.

7.4.1.4 For stowage of AMMONIUM NITRATE (UN 1942), AMMONIUM NITRATE BASED FERTILIZER (UN 2067 AND 2071) in containers, the applicable provisions of 7.6.2.8.4 and 7.6.2.11.1 also apply.

#### 7.4.2 Stowage requirements

##### 7.4.2.1 Provisions for hatchless containerships

Dangerous goods shall only be transported in or vertically above hatchless container holds if:

- .1 the dangerous goods are permitted for under deck stowage as specified in the Dangerous Goods List; and
- .2 the hatchless container hold is in full compliance with the provisions of regulation II-2/19 of SOLAS, as amended, or regulation II-2/54 of SOLAS, as amended by the resolutions indicated in II-2/1.2.1, as applicable.

##### 7.4.2.2 Provisions for ships with partially weathertight hatchway covers

###### 7.4.2.2.1 Provisions for partially weathertight hatchway covers with effective gutterbars\*

7.4.2.2.1.1 Partially weathertight hatchway covers fitted with *effective gutterbars*\* can be regarded as “resistant to fire and liquid” for the purpose of stowage and segregation of containers containing dangerous goods on containerships fitted with such hatchway covers. Additionally segregation requirements shall be in accordance with the requirements in paragraph 7.4.3.2.

7.4.2.2.1.2 When “not in the same vertical line unless separated by a deck” is required, containers containing dangerous goods shall not be stowed in any tier directly above a *clear gap*\* unless the cargo hold complies with the relevant requirements for the class and flashpoint of the dangerous goods in regulation II-2/19 of SOLAS 74, as amended, or regulation II-2/54 of SOLAS, as amended by resolutions indicated in II-2/1.2.1, as applicable. Additionally, containers containing incompatible dangerous goods shall not be stowed within the relevant *sensitive vertical lines*\* under deck.

###### 7.4.2.2.2 Provisions for partially weathertight hatchway covers without effective gutterbars\*

7.4.2.2.2.1 Where hatchway covers are *not fitted with effective gutterbars*, containers containing dangerous goods shall not be stowed on such hatchway covers, unless the cargo hold complies with the relevant requirements

\* For definitions and details see MSC/Circ.1087 found in the IMDG Code Supplement.

for the class and flashpoint of the dangerous goods in regulation II-2/19 of SOLAS 74, as amended, or regulation II-2/54 of SOLAS, as amended by the resolutions indicated in II-2/1.2.1, as applicable.

7.4.2.2.2.2 Where hatchway covers are not fitted with *effective gutterbars*,\* the following applies where stowage “not in the same vertical line” is required in 7.4.3.3.

7.4.2.2.2.3 When containers containing dangerous goods are stowed on deck, containers containing incompatible dangerous goods shall not be stowed within the relevant *sensitive vertical lines*\* of any *clear gap*\* on either side of the hatchway cover below deck.

7.4.2.2.2.4 When containers containing dangerous goods are stowed below deck within the relevant sensitive vertical lines of a clear gap, containers with incompatible dangerous goods shall not be stowed on the hatches above the hold.\*

#### 7.4.2.3 Provisions for containers with flammable gases and highly flammable liquids

7.4.2.3.1 In cargo ships of 500 gross tons or over and passenger ships constructed before 1 September 1984, and in cargo ships of less than 500 gross tons constructed before 1 February 1992, containers with flammable gases or with flammable liquids having a flashpoint of less than 23°C c.c, shall be stowed on deck only, unless otherwise approved by the Administration.

7.4.2.3.2 A container with flammable gases or flammable liquids having a flashpoint of less than 23°C c.c transported on deck shall be stowed at least 2.4 m horizontally and projected vertically away from any potential source of ignition.

7.4.2.3.3 A container under temperature control that is not of a certified safe type shall not be stowed under deck together with containers containing flammable gases or with liquids having a flashpoint of less than 23°C c.c.

#### 7.4.2.4 Ventilation provisions

7.4.2.4.1 In cargo ships of 500 gross tons or over and passenger ships constructed before 1 September 1984, and in cargo ships of less than 500 gross tons constructed before 1 February 1992, containers with the following dangerous goods may be stowed under deck only if the cargo space is equipped with mechanical ventilation and if under deck stowage is permitted in the Dangerous Goods List:

- dangerous goods of class 2.1;
- dangerous goods of class 3 with a flashpoint of less than 23°C c.c.;
- dangerous goods of class 4.3;
- dangerous goods of class 6.1 with a subsidiary hazard of class 3;
- dangerous goods of class 8 with a subsidiary hazard of class 3; and
- dangerous goods to which a specific stowage requirement requiring mechanical ventilation in column 16a of the Dangerous Goods List is assigned.

Otherwise containers shall be stowed on deck only.

7.4.2.4.2 The capacity of the mechanical ventilation (number of air changes per hour) shall be to the satisfaction of the Administration.

### 7.4.3 Segregation requirements

#### 7.4.3.1 Definition and application

7.4.3.1.1 *Container space* means a distance of not less than 6 m fore and aft or not less than 2.4 m athwartships.

7.4.3.1.2 The provisions for segregation between containers on board containerships with closed cargo holds and on board hatchless containerships are given in the tables in 7.4.3.2 and 7.4.3.3, respectively.

\* For definitions and details see MSC/Circ.1087 found in the IMDG Code Supplement.

Part 7 – Provisions concerning transport operations

7.4.3.2 Table of segregation of containers on board container ships with closed cargo holds

| Segregation requirement   | Vertical  |   | Horizontal                          |   |                                     |                                     |                                     |                                     |
|---|---|---|-------------------------------------|---|-------------------------------------|-------------------------------------|-------------------------------------|-------------------------------------|
|   | Closed versus closed                                      | Open versus open  | Closed versus closed                |   | Open versus open                    |                                     | Open versus open                    |                                     |
|   |   |   | On deck                             | Under deck  | On deck                             | Under deck                          | On deck                             | Under deck                          |
| "Away from"<br>.1   | One on top of the other permitted                         | Open on top of closed permitted                           | No restriction                      | No restriction  | No restriction                      | No restriction                      | One container space                 | One container space or one bulkhead |
|   | Otherwise as for "open versus open"                       | Not in the same vertical line unless segregated by a deck | No restriction                      | No restriction  | No restriction                      | No restriction                      | One container space                 | One container space                 |
| "Separated from"<br>.2  | Not in the same vertical line unless segregated by a deck | As for "open versus open"                                 | One container space                 | One container space or one bulkhead                   | One container space                 | One container space or one bulkhead | One container space                 | One bulkhead                        |
|   |   |   | One container space                 | One container space                                   | One container space                 | Two container spaces                | Two container spaces                | One bulkhead                        |
| "Separated by a complete compartment or hold from"<br>.3                              | Not in the same vertical line unless segregated by a deck | As for "open versus open"                                 | One container space                 | One container space                                   | One container space                 | One container space                 | Two container spaces                | Two bulkheads                       |
|   |   |   | Two container spaces                | One bulkhead  | One container space                 | One bulkhead                        | Three container spaces              | Two bulkheads                       |
| "Separated longitudinally by an intervening complete compartment or hold from"<br>.4* | Prohibited  | Prohibited  | Minimum horizontal distance of 24 m | One bulkhead and minimum horizontal distance of 24 m* | Minimum horizontal distance of 24 m | Two bulkheads                       | Minimum horizontal distance of 24 m | Two bulkheads                       |
|   |   |   | Prohibited                          | Prohibited  | Prohibited                          | Prohibited                          | Prohibited                          | Prohibited                          |

\* Containers not less than 6 m from intervening bulkhead.

**Note:** All bulkheads and decks shall be resistant to fire and liquids.

7.4.3.3 Table of segregation of containers on board hatchless containerships

| Segregation requirement  | Vertical                          |   |                               | Horizontal  |   |  |   |   |                                     |
|--|-----------------------------------|---|-------------------------------|---|---|--|---|---|-------------------------------------|
|  | Closed versus closed              | Closed versus open  | Open versus open              | Closed versus closed  |   | Closed versus open                                   |   | Open versus open  |                                     |
|  |                                   |   |                               | On deck   | Under deck  | On deck  | Under deck  | On deck   | Under deck                          |
| "Away from"<br>.1  | One on top of the other permitted | Open on top of closed permitted otherwise as for "open versus open" |                               | No restriction  | No restriction  | No restriction                                       | No restriction  | One container space   | One container space or one bulkhead |
| "Separated from"<br>.2   |                                   |   |                               | No restriction  | No restriction  | One container space or one bulkhead                  | One container space   | One container space   | One container space                 |
| "Separated by a complete compartment or hold from"<br>.3                             | Not in the same vertical line     | As for "open versus open"   | Not in the same vertical line | One container space   | One container space   | One container space                                  | Two container spaces  | Two container spaces and not in or above same hold                | Two bulkheads                       |
| "Separated longitudinally by an intervening complete compartment or hold from"<br>.4 |                                   | Prohibited  |                               | Two container spaces and not in or above same hold                | Two container spaces and not in or above same hold                | One bulkhead   | One bulkhead  | Three container spaces and not in or above same hold              | Two bulkheads                       |
|  |                                   |   |                               | Minimum horizontal distance of 24 m and not in or above same hold | Minimum horizontal distance of 24 m and not in or above same hold | One bulkhead and minimum horizontal distance of 24 m | Minimum horizontal distance of 24 m and not in or above same hold | Minimum horizontal distance of 24 m and not in or above same hold | Two bulkheads                       |
|  |                                   |   |                               | Prohibited  | Prohibited  | Prohibited   | Prohibited  | Prohibited  | Prohibited                          |

\* Containers not less than 6 m from intervening bulkhead.

**Note:** All bulkheads and decks shall be resistant to fire and liquids.



## Chapter 7.5

### *Stowage and segregation on ro-ro ships*

**Note:** To facilitate familiarization with these requirements and to support training of relevant personnel, illustrations applicable to the segregation requirements on ro-ro ships are given in MSC.1/Circ.1440.

#### 7.5.1 Introduction

7.5.1.1 The provisions of this chapter apply to the stowage and segregation of cargo transport units which are transported in ro-ro cargo spaces.

7.5.1.2 For ro-ro ships which incorporate stowage positions which are properly fitted to give a permanent stowage of containers during transport, the provisions of chapter 7.4 apply for containers carried in these spaces.

7.5.1.3 For ro-ro ships which incorporate conventional cargo spaces, the provisions of chapter 7.6 apply in these spaces.

7.5.1.4 In case more than one container is loaded on the same chassis in a ro-ro cargo space, the segregation of chapter 7.4 applies between the containers.

#### 7.5.2 Stowage provisions

7.5.2.1 Loading and unloading operations on each ro-ro cargo space shall take place under the supervision of either a working party consisting of officers and other crew members or responsible persons appointed by the master.

7.5.2.2 During the voyage, access to such spaces by passengers and other unauthorized persons shall only be permitted when such persons are accompanied by an authorized crew member.

7.5.2.3 All doors leading directly to these spaces shall be securely closed during the voyage and notices or signs prohibiting entrance to such spaces shall be conspicuously displayed.

7.5.2.4 The transport of dangerous goods shall be prohibited in any ro-ro cargo space in which the foregoing provisions cannot be met.

7.5.2.5 Closing arrangements for the openings between ro-ro cargo spaces and machinery and accommodation spaces shall be such as to avoid the possibility of dangerous vapours and liquids entering such spaces. Such openings shall normally be kept securely closed when dangerous cargo is on board, except to permit access by authorized persons or for emergency use.

7.5.2.6 Dangerous goods required to be carried on deck only shall not be carried in closed ro-ro cargo spaces, but may be carried in open ro-ro cargo spaces when authorized by the Administration.

7.5.2.7 Flammable gases or liquids having a flashpoint of less than 23°C c.c. shall not be stowed in a closed ro-ro cargo space or special category space on a passenger ship unless:

- the design, construction and equipment of the space comply with the provisions of regulation II-2/19 of SOLAS, as amended, or regulation II-2/54 of SOLAS, as amended by the resolutions indicated in II-2/1.2.1, as applicable, and the ventilation system is operated to maintain at least six air changes per hour; or
- the ventilation system of the space is operated to maintain at least ten air changes per hour and non-certified safe electrical systems in the space are capable of being isolated by means other than removal of fuses in the event of failure of the ventilation system or any other circumstance likely to cause accumulation of flammable vapours.

Otherwise stowage is restricted to *on deck only*.

7.5.2.8 Cargo transport units with flammable gases or liquids having a flashpoint of less than 23°C c.c. and transported on deck shall be stowed at least 3 m from any potential sources of ignition.

- 7.5.2.9 Mechanically operated refrigeration or heating equipment fitted to any cargo transport unit shall not be operated during the voyage when stowed in a closed ro-ro cargo space or a special category space on a passenger ship.
- 7.5.2.10 Electrically operated refrigeration or heating equipment fitted to any cargo transport unit stowed in a closed ro-ro cargo space or special category space on a passenger ship shall not be operated when flammable gases or liquids having a flashpoint of less than 23°C c.c. are present in the cargo transport unit or in the same space, unless:
- the design, construction and equipment of the space comply with the provisions of regulation II-2/19 of SOLAS, as amended, or regulation II-2/54 of SOLAS, as amended by the resolutions indicated in II-2/1.2.1, as applicable; or
  - the ventilation system of the space is operated to maintain at least ten air changes per hour and all electrical systems in the space are capable of being isolated by means other than removal of fuses in the event of ventilation failure or other circumstance likely to cause accumulation of flammable vapours;
  - and, in either case, the refrigeration or heating equipment of the cargo transport unit shall comply with paragraph 7.3.7.6.
- 7.5.2.11 In ships the keel of which was laid before 1 September 1984 and for which regulation II-2/20 of SOLAS, as amended, or regulations II-2/37 and 38 of SOLAS, as amended by the resolutions indicated in II-2/1.2.1, are not applicable to a closed ro-ro cargo space, mechanical ventilation shall be provided to the satisfaction of the Administration. The ventilation fans shall be operating at all times when vehicles are in such spaces.
- 7.5.2.12 If continuous ventilation is impracticable in a closed ro-ro cargo space other than a special category space on a passenger ship, ventilation fans shall be operated daily for a limited period, as weather permits. In any case, prior to discharge, the fans shall be operated for a reasonable period. The ro-ro cargo space shall be proved gas-free at the end of the period. When the ventilation is not continuous, electrical systems which are not certified safe shall be isolated.
- 7.5.2.13 The master of a ship carrying dangerous goods in ro-ro cargo spaces shall ensure that, during loading and unloading operations and during the voyage, regular inspections of these spaces are made by an authorized crew member or responsible person in order to achieve early detection of any hazard.

### 7.5.3 Segregation provisions

7.5.3.1 The provisions for segregation between cargo transport units onboard ro-ro ships are given in the table in 7.5.3.2.

7.5.3.2 Table of segregation of cargo transport units on board ro-ro ships

| Segregation requirement  | Horizontal   |                      |  |                    |                                       |                  |                               |
|--|--------------|----------------------|--|--------------------|---------------------------------------|------------------|-------------------------------|
|  |              | Closed versus closed |  | Closed versus open |                                       | Open versus open |                               |
|  |              | On deck              | Under deck                                 | On deck            | Under deck                            | On deck          | Under deck                    |
| “Away from”<br>.1  | Fore and aft | No restriction       | No restriction                             | No restriction     | No restriction                        | At least 3 m     | At least 3 m                  |
|  | Athwartships | No restriction       | No restriction                             | No restriction     | No restriction                        | At least 3 m     | At least 3 m                  |
| “Separated from”<br>.2   | Fore and aft | At least 6 m         | At least 6 m or one bulkhead               | At least 6 m       | At least 6 m or one bulkhead          | At least 6 m     | At least 12 m or one bulkhead |
|  | Athwartships | At least 3 m         | At least 3 m or one bulkhead               | At least 3 m       | At least 6 m or one bulkhead          | At least 6 m     | At least 12 m or one bulkhead |
| “Separated by a complete compartment or hold from”<br>.3                             | Fore and aft | At least 12 m        | At least 24 m + deck                       | At least 24 m      | At least 24 m + deck                  | At least 36 m    | Two decks or two bulkheads    |
|  | Athwartships | At least 12 m        | At least 24 m + deck                       | At least 24 m      | At least 24 m + deck                  | Prohibited       | Prohibited                    |
| “Separated longitudinally by an intervening complete compartment or hold from”<br>.4 | Fore and aft | At least 36 m        | Two bulkheads or at least 36 m + two decks | At least 36 m      | At least 48 m including two bulkheads | At least 48 m    | Prohibited                    |
|  | Athwartships | Prohibited           | Prohibited                                 | Prohibited         | Prohibited                            | Prohibited       | Prohibited                    |

**Note:** All bulkheads and decks shall be resistant to fire and liquid.

## Chapter 7.6

### *Stowage and segregation on general cargo ships*

#### 7.6.1 Introduction

- 7.6.1.1 The provisions of this chapter apply to the stowage and segregation of dangerous goods stowed in the conventional way on board general cargo ships. They apply also to containers which are transported in conventional cargo spaces, including cargo spaces on the weather deck, not properly fitted to give a permanent stowage of the containers during transport.
- 7.6.1.2 For ships carrying containers in stowage positions which are properly fitted for the permanent stowage of containers the provisions of chapter 7.4 apply.

#### 7.6.2 Stowage and handling provisions

##### 7.6.2.1 Provisions for all classes

- 7.6.2.1.1 The minimum stacking height for testing packagings intended to contain dangerous goods in accordance with chapter 6.1 is 3 m. For IBCs and large packagings, the stacking test load shall be determined in accordance with 6.5.6.6.4 and 6.6.5.3.3.4 respectively.
- 7.6.2.1.2 Drums containing dangerous goods shall always be stowed in an upright position unless otherwise authorized by the competent authority.
- 7.6.2.1.3 The stowage of dangerous goods shall be so arranged as to ensure clear walkways and access to all facilities necessary for the safe working of the ship. When dangerous goods are stowed on deck, hydrants, sounding pipes and the like and access thereto shall be kept free and clear of such goods.
- 7.6.2.1.4 Fibreboard packagings, paper bags and other packages susceptible to water damage shall be stowed *under deck* or, if they are stowed on deck, they shall be so protected that at no time are they exposed to weather or to seawater.
- 7.6.2.1.5 Portable tanks shall not be overstowed by other cargo unless they are designed for that purpose or unless they are protected to the satisfaction of the competent authority.
- 7.6.2.1.6 Cargo spaces and decks shall be clean and dry as relevant to the hazards of the dangerous goods to be carried. In order to reduce the risk of ignition, the space shall be free of dust from other cargoes, such as grain or coal dust.
- 7.6.2.1.7 Packages and cargo transport units found to be damaged, leaking or sifting shall not be loaded on a general cargo ship. Care shall be taken to ensure that excessive water, snow, ice or foreign matter adhering to packages and cargo transport units shall be removed before loading.
- 7.6.2.1.8 Packages and cargo transport units and any other goods shall be adequately braced and secured for the voyage.\* Packages shall be loaded in such a way that there will be a minimum likelihood of damage to them and to any fittings during transport. Fittings on packages or portable tanks shall be adequately protected.

##### 7.6.2.2 Provisions for flammable gases and highly flammable liquids

- 7.6.2.2.1 In cargo ships of 500 gross tons or over and passenger ships constructed before 1 September 1984, and in cargo ships of less than 500 gross tons constructed before 1 February 1992, flammable gases or flammable liquids having a flashpoint of less than 23°C c.c., shall be stowed on deck only, unless otherwise approved by the Administration.
- 7.6.2.2.2 Flammable gases or liquids having a flashpoint less than 23°C c.c. transported on deck shall be stowed at least 3 m from any potential source of ignition.

\* Refer to regulation VII/5 of SOLAS, as amended.

**7.6.2.3 Ventilation provisions**

7.6.2.3.1 In cargo ships of 500 gross tons or over and passenger ships constructed before 1 September 1984, and in cargo ships of less than 500 gross tons constructed before 1 February 1992, the following dangerous goods, may be stowed *under deck* only if the cargo space is equipped with mechanical ventilation and if under deck stowage is permitted in the Dangerous Goods List:

- dangerous goods of class 2.1;
- dangerous goods of class 3 with a flashpoint of less than 23°C c.c.;
- dangerous goods of class 4.3;
- dangerous goods of class 6.1 with a subsidiary hazard of class 3;
- dangerous goods of class 8 with a subsidiary hazard of class 3, and
- dangerous goods to which a specific stowage requirement requiring mechanical ventilation in column 16a of the Dangerous Goods List is assigned.

Otherwise containers shall be stowed on deck only.

7.6.2.3.2 The capacity of the mechanical ventilation (number of air changes per hour) shall be to the satisfaction of the Administration.

**7.6.2.4 Provisions for class 1**

7.6.2.4.1 All compartments or holds and cargo transport units shall be locked or suitably secured in order to prevent unauthorized access. The means of locking and securing shall be such that, in the case of emergency, access can be gained without delay.

7.6.2.4.2 Loading and unloading procedures and equipment used should be of such a nature that sparks are not produced, in particular where the floors of the cargo compartment are not constructed of close-boarded wood. All cargo handlers should be briefed by the shipper or receiver of the potential risks and necessary precautions, prior to commencing the handling of explosives. In the event of the contents of packages being affected by water whilst on board, immediate advice shall be sought from the shipper; pending this advice, handling of the packages shall be avoided.

**7.6.2.4.3 Segregation on deck**

When goods in different compatibility groups are transported on deck, they shall be stowed not less than 6 m apart unless their mixed stowage is allowed according to 7.2.7.

**7.6.2.4.4 Segregation in single hold ships**

In a single hold ship, dangerous goods of class 1 shall be segregated in accordance with 7.2.7 except that:

- .1 Goods in Division 1.1 or 1.2 of compatibility group B may be stowed in the same hold as substances of compatibility group D provided:
  - the net explosives mass of goods of compatibility group B does not exceed 50 kg; and
  - such goods are stowed in a closed cargo transport unit which is stowed at least 6 m from the substances of compatibility group D.
- .2 Goods in Division 1.4 of compatibility group B may be stowed in the same hold as substances of compatibility group D provided they are separated either by a distance of at least 6 m or by a steel division.

7.6.2.4.5 In the event that a package containing goods of class 1 is found to be suffering from breakage or leakage expert advice should be obtained for its safe handling and disposal.

**7.6.2.5 Provisions for class 2**

7.6.2.5.1 When pressure receptacles are stowed in a vertical position they shall be stowed in a block, cribbed or boxed-in with suitable sound lumber and the box or crib dunnaged to provide clearance from a steel deck. Pressure receptacles in a box or crib shall be braced to prevent any movement. The box or crib (gas rack) shall be securely chocked and lashed to prevent movement in any direction.

7.6.2.5.2 Pressure receptacles stowed on deck shall be protected from sources of heat.

**7.6.2.6 Provisions for class 3**

7.6.2.6.1 Class 3 substances with a flashpoint of less than 23°C c.c. packaged in jerricans, plastics (3H1, 3H2), drums, plastics (1H1, 1H2), plastics receptacles in a plastic drum (6HH1, 6HH2) and Plastic Intermediate Bulk Containers (IBCs 31H1 and 31H2), shall be stowed *on deck only* unless packed in a closed cargo transport unit.



**7.6.2.7.3 Stowage provisions for SEED CAKE (UN 1386)**

**7.6.2.7.3.1** Stowage provisions for SEED CAKE, containing vegetable oil (a) mechanically expelled seeds, containing more than 10% oil or more than 20% oil and moisture combined:

- .1 through and surface ventilation is required;
- .2 if the voyage exceeds 5 days, the ship shall be equipped with facilities for introducing carbon dioxide or inert gas into the cargo spaces;
- .3 bags shall always be stowed in double strip, as shown in 7.6.2.7.2.3 of this Code for fish meal, unstabilized; and
- .4 regular temperature readings shall be taken at varying depths in the cargo space and recorded. If the temperature of the cargo exceeds 55°C and continues to increase, ventilation to the cargo spaces shall be restricted. If self-heating continues, then carbon dioxide or inert gas shall be introduced.

**7.6.2.7.3.2** Stowage provisions for SEED CAKE, containing vegetable oil (b) solvent extractions and expelled seeds containing not more than 10% of oil and, when the amount of moisture is higher than 10%, not more than 20% of oil and moisture combined:

- .1 surface ventilation is required to assist in removing any residual solvent vapour;
- .2 if bags are stowed without provision for ventilation to circulate throughout the stow and the voyage exceeds 5 days, regular temperature readings shall be taken at varying depths in the hold and recorded; and
- .3 if the voyage exceeds 5 days, the vessel shall be equipped with facilities for introducing carbon dioxide or inert gas into the cargo spaces.

**7.6.2.8 Provisions for class 5.1**

**7.6.2.8.1** Cargo spaces shall be cleaned before oxidizing substances are loaded into them. All combustible materials which are not necessary for the stowage of such cargoes shall be removed from the hold.

**7.6.2.8.2** As far as reasonably practicable, non-combustible securing and protecting materials and only a minimum of clean dry wooden dunnage shall be used.

**7.6.2.8.3** Precautions shall be taken to avoid the penetration of oxidizing substances into other cargo spaces, bilges, etc., which may contain combustible material.

△ **7.6.2.8.4** UN 1942 AMMONIUM NITRATE and UN 2067 AMMONIUM NITRATE BASED FERTILIZER may be stowed under deck in a clean cargo space capable of being opened up in an emergency. The possible need to open hatches in case of fire to provide maximum ventilation and to apply water in an emergency and the consequent risk to the stability of the ship through flooding of cargo space shall be considered before loading. The requirement for opening the cargo space hatches applies to the weather deck and tween deck hatches (if any).

**7.6.2.8.5** After discharge, cargo spaces used for the transport of oxidizing substances shall be inspected for contamination. A space that has been contaminated shall be properly cleaned and examined before being used for other cargoes.

**7.6.2.9 Provisions for self-reactive substances of class 4.1 and for class 5.2**

**7.6.2.9.1** Packages shall be stowed protected from sources of heat.

**7.6.2.9.2** When stowage arrangements are made, it shall be borne in mind that it may become appropriate to jettison a package or packages of this cargo.

**7.6.2.10 Provisions for classes 6.1 and 8**

**7.6.2.10.1** After discharge, spaces used for the transport of substances of this class shall be inspected for contamination. A space which has been contaminated shall be properly cleaned and examined before being used for other cargoes.

**7.6.2.10.2** Substances of class 8 shall be kept as dry as reasonably practicable, since in the presence of moisture they may be corrosive to most metals and some also react violently with water.

**Part 7 – Provisions concerning transport operations**

---

**7.6.2.11 Stowage of goods of class 9****7.6.2.11.1 Stowage provisions for AMMONIUM NITRATE BASED FERTILIZER, UN 2071**

7.6.2.11.1.1 AMMONIUM NITRATE BASED FERTILIZER, UN 2071 shall be stowed in a clean cargo space capable of being opened up in an emergency. In the case of bagged fertilizer or fertilizer in containers or in bulk containers, it is sufficient if, in the case of an emergency, the cargo is accessible through free approaches (hatch entries), and mechanical ventilation enables the master to exhaust any gases or fumes resulting from decomposition. The possible need to open hatches in case of fire to provide maximum ventilation and to apply water in an emergency, and the consequent risk to the stability of the ship through flooding of the cargo space, shall be considered before loading.

7.6.2.11.1.2 If suppression of decomposition should prove impracticable (such as in bad weather), there would not necessarily be immediate danger to the structure of the ship. However, the residue left after decomposition may have only half the mass of the original cargo; this loss of mass may also affect the stability of the ship and shall be considered before loading.

7.6.2.11.1.3 AMMONIUM NITRATE BASED FERTILIZER, UN 2071 shall be stowed out of direct contact with a metal engine-room bulkhead. In the case of bagged material, this may be done, for example, by using wooden boards to provide an air space between the bulkhead and the cargo. This requirement need not apply to short international voyages.

7.6.2.11.1.4 In the case of ships not fitted with smoke-detecting or other suitable devices, arrangements shall be made during the voyage to inspect cargo spaces containing these fertilizers at intervals not exceeding 4 h (such as to sniff at the ventilators serving them) to ensure early detection of decomposition should that occur.

**7.6.2.11.2 Stowage provisions for FISH MEAL, STABILIZED (UN 2216, class 9)**

7.6.2.11.2.1 For stowage provisions for FISH MEAL, STABILIZED (UN 2216, class 9), see 7.6.2.7.2.

**7.6.2.12 Stowage of dangerous goods in flexible bulk containers**

7.6.2.12.1 The stowage of dangerous goods in flexible bulk containers is not permitted on deck.

7.6.2.12.2 Flexible bulk containers shall be stowed in such a way that there are no void spaces between flexible bulk containers in the hold. If the flexible bulk containers do not completely fill the hold, adequate measures shall be taken to avoid shifting of cargo.

7.6.2.12.3 The maximum permissible stacking height of flexible bulk containers shall never exceed three high.

7.6.2.12.4 When flexible bulk containers are fitted with venting devices, the stowage of the flexible bulk containers shall not impede their function.

**7.6.3 Segregation provisions****7.6.3.1 Segregation from foodstuffs**

7.6.3.1.1 For the purpose of this subsection, the terms “away from”, “separated from” and “separated by a complete compartment or hold from” are defined in 7.6.3.2.

7.6.3.1.2 Dangerous goods having a primary or subsidiary hazard of classes 2.3, 6.1, 7 (with the exception of UN 2908, 2909, 2910 and 2911), 8 and dangerous goods for which it is referred to in segregation code SG29 or SG50 in column 16b of the Dangerous Goods List stowed in a conventional way shall be “separated from” foodstuffs stowed in a conventional way. If either dangerous goods or foodstuffs are in a closed cargo transport unit, dangerous goods shall be stowed “away from” foodstuffs. If both dangerous goods and foodstuffs are in different closed cargo transport units, no segregation requirements shall apply.

7.6.3.1.3 Dangerous goods of class 6.2 stowed in a conventional way shall be “separated by a complete compartment or hold from” foodstuffs stowed in a conventional way. If either dangerous goods or foodstuffs are in a closed cargo transport unit, dangerous goods shall be stowed “separated from” foodstuffs.



7.6.3.2 Segregation of packages containing dangerous goods and stowed in the conventional way

**Definitions of the segregation terms**

*Away from:*

Effectively segregated so that the incompatible goods cannot interact dangerously in the event of an accident but may be transported in the same compartment or hold or *on deck*, provided a minimum horizontal separation of 3 m, projected vertically, is obtained.

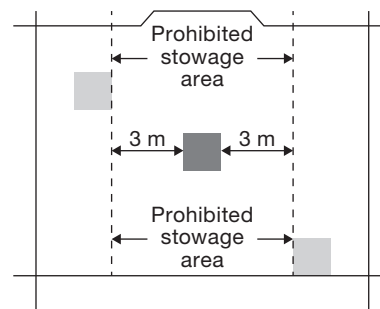

*Separated from:*

In different compartments or holds when stowed *under deck*. Provided the intervening deck is resistant to fire and liquid, a vertical separation, i.e. in different compartments, may be accepted as equivalent to this segregation. For *on deck* stowage, this segregation means a separation by a distance of **at least 6 m horizontally**.

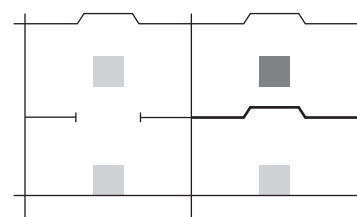

*Separated by a complete compartment or hold from:*

Either a vertical or a horizontal separation. If the intervening decks are not resistant to fire and liquid, then only a longitudinal separation, i.e. by an intervening complete compartment or hold, is acceptable. For *on deck* stowage, this segregation means a separation by a distance of **at least 12 m horizontally**. The same distance has to be applied if one package is stowed on deck, and the other one in an upper compartment.

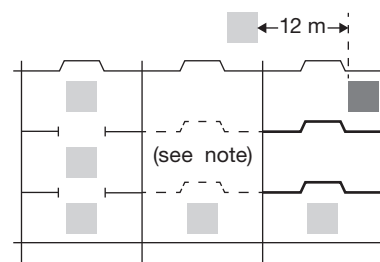

**Note:** One of the two decks must be resistant to fire and to liquid

*Separated longitudinally by an intervening complete compartment or hold from:*

Vertical separation alone does not meet this requirement. Between a package *under deck* and one on deck, a minimum distance of 24 m, including a complete compartment, must be maintained longitudinally. For *on deck* stowage, this segregation means a separation by a distance of **at least 24 m longitudinally**.

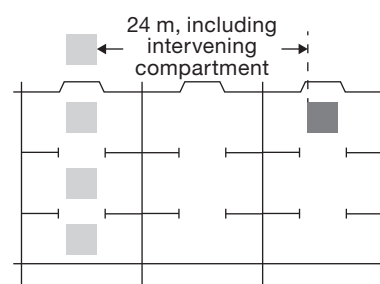

**Legend**

- Reference package . . . . .
- Package containing incompatible goods . . . . .
- Deck resistant to fire and liquid . . . . .

**Note:** Vertical lines represent transverse watertight bulkheads between cargo spaces.

Part 7 – Provisions concerning transport operations

- 7.6.3.3 Segregation of dangerous goods stowed in the conventional way from those transported in cargo transport units**
- 7.6.3.3.1** Dangerous goods stowed in the conventional way shall be segregated from goods transported in open cargo transport units in accordance with 7.6.3.2.
- 7.6.3.3.2** Dangerous goods stowed in the conventional way shall be segregated from goods transported in closed cargo transport units in accordance with 7.6.3.2 except that:
- .1 where “away from” is required, no segregation between the packages and the closed cargo transport units is required; and
  - .2 where “separated from” is required, the segregation between the packages and the closed cargo transport units may be as for “away from” as defined in 7.6.3.2.
- 7.6.3.4 Segregation of dangerous goods in cargo transport units stowed in conventional cargo spaces**
- 7.6.3.4.1** Dangerous goods in different closed cargo transport units (closed freight containers) stowed in holds and compartments not properly fitted to give a permanent stowage of the containers during transport shall be segregated from each other in accordance with 7.6.3.2 except that:
- .1 where “away from” is required, no segregation between the closed cargo transport units is required; and
  - .2 where “separated from” is required, the segregation between the closed cargo transport units may be as for “away from” as defined in 7.6.3.2.
- 7.6.3.5 Segregation between bulk materials possessing chemical hazards and dangerous goods in packaged form**
- 7.6.3.5.1** Unless otherwise required in this Code or in the IMSBC Code, segregation between bulk materials possessing chemical hazards and dangerous goods in packaged form shall be in accordance with the following table.
- 7.6.3.5.2 Segregation table**

| Bulk materials (classified as dangerous goods)                | Dangerous goods in packaged form |                   |            |     |     |            |   |     |     |     |     |     |     |     |   |   |   |
|---|----------------------------------|-------------------|------------|-----|-----|------------|---|-----|-----|-----|-----|-----|-----|-----|---|---|---|
|   | CLASS                            | 1.1<br>1.2<br>1.5 | 1.3<br>1.6 | 1.4 | 2.1 | 2.2<br>2.3 | 3 | 4.1 | 4.2 | 4.3 | 5.1 | 5.2 | 6.1 | 6.2 | 7 | 8 | 9 |
| Flammable solids  | 4.1                              | 4                 | 3          | 2   | 2   | 2          | 2 | X   | 1   | X   | 1   | 2   | X   | 3   | 2 | 1 | X |
| Substances liable to spontaneous combustion                   | 4.2                              | 4                 | 3          | 2   | 2   | 2          | 2 | 1   | X   | 1   | 2   | 2   | 1   | 3   | 2 | 1 | X |
| Substances which, in contact with water, emit flammable gases | 4.3                              | 4                 | 4          | 2   | 2   | X          | 2 | X   | 1   | X   | 2   | 2   | X   | 2   | 2 | 1 | X |
| Oxidizing substances (agents)                                 | 5.1                              | 4                 | 4          | 2   | 2   | X          | 2 | 1   | 2   | 2   | X   | 2   | 1   | 3   | 1 | 2 | X |
| Toxic substances  | 6.1                              | 2                 | 2          | X   | X   | X          | X | X   | 1   | X   | 1   | 1   | X   | 1   | X | X | X |
| Radioactive material  | 7                                | 2                 | 2          | 2   | 2   | 2          | 2 | 2   | 2   | 2   | 1   | 2   | X   | 3   | X | 2 | X |
| Corrosive substance   | 8                                | 4                 | 2          | 2   | 1   | X          | 1 | 1   | 1   | 1   | 2   | 2   | X   | 3   | 2 | X | X |
| Miscellaneous dangerous substances and articles               | 9                                | X                 | X          | X   | X   | X          | X | X   | X   | X   | X   | X   | X   | X   | X | X | X |
| Materials hazardous only in bulk (MHB)                        |                                  | X                 | X          | X   | X   | X          | X | X   | X   | X   | X   | X   | X   | 3   | X | X | X |

Numbers and symbols relate to the following terms, as defined in this chapter:

- 1 – “away from”
- 2 – “separated from”
- 3 – “separated by a complete compartment or hold from”
- 4 – “separated longitudinally by an intervening complete compartment or hold from”
- X – the segregation, if any, is shown in the Dangerous Goods List in this Code or the individual entries in the IMSBC Code

7.6.3.5.3 *Definitions of the segregation terms*

*Away from:*

Effectively segregated so that incompatible materials cannot interact dangerously in the event of an accident but may be transported in the same compartment or hold or *on deck* provided a minimum horizontal separation of 3 m, projected vertically, is provided.

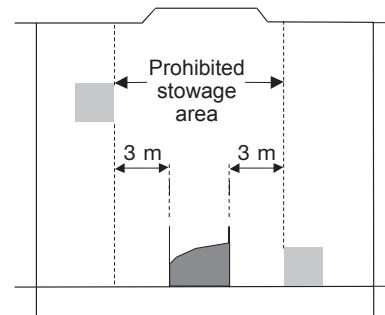

*Separated from:*

In different holds when stowed *under deck*. Provided an intervening deck is resistant to fire and liquid, a vertical separation, i.e. in different compartments, may be accepted as equivalent to this segregation.

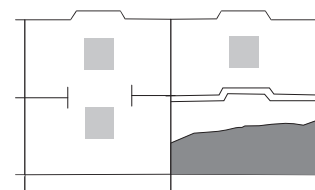

*Separated by a complete compartment or hold from:*

Either a vertical or a horizontal separation. If the decks are not resistant to fire and liquid, then only a longitudinal separation, i.e. by an intervening complete compartment, is acceptable.

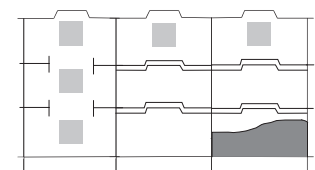

*Separated longitudinally by an intervening complete compartment or hold from:*

Vertical separation alone does not meet this requirement.

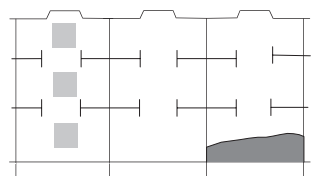

**Legend**

- Reference bulk material .....
- Package containing incompatible goods .....
- Deck resistant to fire and liquid .....

**Note:** Vertical lines represent transverse watertight bulkheads between cargo spaces.

## Chapter 7.7

### *Shipborne barges on barge-carrying ships*

#### 7.7.1 Introduction

7.7.1.1 The provisions of this chapter are applicable to shipborne barges which contain packaged dangerous goods or solid bulk materials possessing chemical hazards while aboard barge-carrying ships.

7.7.1.2 Barges used for the shipborne transport of packaged dangerous goods or solid bulk materials possessing chemical hazards shall be of proper design and adequate strength to resist the stresses imposed by the conditions of the services in which they are employed and they shall be adequately maintained. Shipborne barges shall be approved in accordance with provisions for certification of a recognized classification society, or any organization approved by and acting on behalf of the competent authority of the countries concerned.

#### 7.7.2 Definitions

7.7.2.1 *Loading*, for the purpose of this chapter, means the placement of cargo into a shipborne barge.

7.7.2.2 *Stowage*, for the purposes of this chapter, means the placement of a shipborne barge aboard the barge-carrying ship.

#### 7.7.3 Barge loading

7.7.3.1 Packages shall be examined and any found to be damaged, leaking or sifting shall not be loaded into a shipborne barge. Care shall be taken to ensure that excessive water, snow, ice or foreign matter adhering to packages shall be removed before loading into a shipborne barge.

7.7.3.2 Packages containing dangerous goods, cargo transport units and any other goods within a shipborne barge shall be adequately braced and secured for the voyage. Packages shall be loaded in such a way that there will be a minimum likelihood of damage to them and to any fittings during transport. Fittings on packages or portable tanks shall be adequately protected.

7.7.3.3 Certain dry dangerous goods may be transported in bulk in shipborne barges; this is indicated by the Code "BK2" in column 13 of the Dangerous Goods List. Where such solid bulk materials possessing chemical hazards are transported in shipborne barges, it shall be ensured that at all times the cargo is evenly distributed, properly trimmed and secured.

7.7.3.4 Shipborne barges into which packaged dangerous goods or solid bulk materials possessing chemical hazards are to be loaded shall be examined visually for hull or hatch cover damage which could impair watertight integrity. If there is evidence of such damage, the shipborne barge may not be used for the transport of packaged dangerous goods or solid bulk materials possessing chemical hazards and shall not be loaded.

7.7.3.5 Dangerous goods which have to be segregated from each other according to the provisions in chapter 7.2 shall not be transported in the same barge with the exception of dangerous goods which shall be segregated "away from" each other which may be transported in the same barge with the approval of the competent authority. In such cases an equivalent standard of safety shall be maintained.

7.7.3.6 Dangerous goods having a primary or subsidiary hazard of classes 2.3, 6.1, 6.2, 7 (with the exception of UN 2908, 2909, 2910 and 2911), 8 and dangerous goods for which it is referred to in segregation code SG29 or SG50 in column 16b of the Dangerous Goods List shall not be transported together with foodstuffs (see 1.2.1) in the same barge.

7.7.3.7 Notwithstanding the provisions in 7.7.3.6, the following dangerous goods may be transported with foodstuffs in the same barge provided that they are not loaded within 3 m from foodstuffs:

- .1 dangerous goods of packing group III of classes 6.1 and 8;
- .2 dangerous goods of packing group II of class 8;
- .3 any other dangerous goods of packing group III with a subsidiary hazard of classes 6.1 or 8; and

.4 dangerous goods having a reference to 7.7.3.7 in column 16b of the Dangerous Goods List.

7.7.3.8 Shipborne barges containing a residue of a dangerous cargo or shipborne barges loaded with empty packagings still containing a residue of a dangerous substance shall comply with the same provisions as barges loaded with the substance itself.

#### 7.7.3.9 Stowage of dangerous goods in flexible bulk containers

7.7.3.9.1 Flexible bulk containers shall be stowed in the barge in such a way that there are no void spaces between the flexible bulk containers in the barge. If the flexible bulk containers do not completely fill the barge, adequate measures shall be taken to avoid shifting of cargo.

7.7.3.9.2 The maximum permissible height of the stack of the flexible bulk containers shall never exceed three high.

7.7.3.9.3 When flexible bulk containers are fitted with venting devices, the stowage of the flexible bulk containers in their barge shall not impede their function.

### 7.7.4 Stowage of shipborne barges

7.7.4.1 Stowage of shipborne barges carrying packaged dangerous goods or solid bulk materials possessing chemical hazards aboard barge-carrying ships shall be as required for the substance in chapter 7.1 and in column 16a of the Dangerous Goods List. When a shipborne barge is loaded with more than one substance, and the stowage locations differ for the substances (i.e. some substances require *on deck* stowage while other substances require *under deck* stowage), the shipborne barge containing these substances shall be stowed on deck.

7.7.4.2 Provision shall be made to ensure that shipborne barges stowed under deck and loaded with cargoes requiring ventilation because of their dangerous nature are ventilated to the extent necessary.

7.7.4.3 Where it is required that a dangerous good shall be protected from sources of heat, this provision shall be applied to the shipborne barge as a whole, unless suitable alternative measures are provided.

7.7.4.4 When packaged dangerous goods or solid bulk materials possessing chemical hazards are loaded in shipborne barges aboard barge-carrying ships having the capability of providing fixed fire-fighting systems or fire-detection systems to individual barges, care shall be taken to ensure that these systems are attached to the shipborne barge and operating properly.

7.7.4.5 When packaged dangerous goods or solid bulk materials possessing chemical hazards are loaded in shipborne barges aboard barge-carrying ships having fixed fire-fighting systems or fire-detection systems installed in individual barge holds, care shall be taken to ensure that the ventilation closures on the shipborne barges are open, to permit the fire fighting medium to enter the barges in case of fire.

7.7.4.6 When ventilation ducts are provided to individual shipborne barges, the ventilation fans shall be secured when fire-fighting medium is introduced into the hold to permit the medium to enter the shipborne barges.

### 7.7.5 Segregation between barges on board barge-carrying ships

7.7.5.1 For barge-carrying ships which incorporate other cargo spaces or any other method of stowage, the appropriate chapter shall apply to the relevant cargo space.

7.7.5.2 When a shipborne barge is loaded with two or more substances with different provisions for segregation, the most stringent segregation applicable shall be applied.

7.7.5.3 “Away from” and “separated from” require no segregation between shipborne barges.

7.7.5.4 “Separated by a complete compartment or hold from” means, for barge-carrying ships with vertical holds, that separate holds are required. On barge-carrying ships having horizontal barge levels, separate barge levels are required and the barges shall not be in the same vertical line.

7.7.5.5 “Separated longitudinally by an intervening complete compartment or hold from” means, for barge-carrying ships with vertical holds, that separation by an intervening hold or engine room is required. On barge-carrying ships having horizontal barge levels, separate barge levels and a longitudinal separation by at least two intervening barge spaces is required.

## Chapter 7.8

### *Special requirements in the event of an incident and fire precautions involving dangerous goods*

**Note:** The provisions of this chapter are not mandatory.

#### 7.8.1 General

7.8.1.1 In the event of an incident involving dangerous goods, detailed recommendations are contained in *The EmS Guide: Revised Emergency Response Procedures for Ships Carrying Dangerous Goods*.

7.8.1.2 In the event of personnel exposure during an incident involving dangerous goods, detailed recommendations are contained in *Medical First Aid Guide for Use in Accidents Involving Dangerous Goods (MFAG)*.

7.8.1.3 In the event that a package containing dangerous goods is found to be suffering from breakage or leakage while the ship is in port, the port authorities should be informed and appropriate procedures should be followed.

#### 7.8.2 General provisions in the event of incidents

7.8.2.1 Recommendations on emergency action may differ depending on whether or not the goods are stowed on deck or under deck or whether a substance is gaseous, liquid or solid. When dealing with incidents involving flammable gases, or flammable liquids with a flashpoint of 60°C closed-cup (c.c.) or below, all sources of ignition (such as naked lights, unprotected light bulbs, electric handtools) should be avoided.

7.8.2.2 In general, the recommendation is to wash spillages on deck overboard with copious quantities of water and, where there is likely to be a dangerous reaction with water, from as far away as practicable. Disposal of spilt dangerous goods overboard is a matter for judgement by the master, bearing in mind that the safety of the crew has priority over pollution of the sea. If it is safe to do so, spillages and leakages of substances, articles and materials identified in this Code as MARINE POLLUTANT should be collected for safe disposal. Inert absorbent material should be used for liquids.

7.8.2.3 Toxic, corrosive and/or flammable vapours in under deck cargo spaces should, where possible, be dispersed before undertaking any emergency action. Where a mechanical ventilation system is used, care will be necessary to ensure that flammable vapours are not ignited.

7.8.2.4 If there is any reason to suspect leakage of these substances, entry into a hold or cargo space should not be permitted until the master or responsible officer has taken all safety considerations into account and is satisfied that it is safe to do so.

7.8.2.5 Emergency entry into the hold under other circumstances should only be undertaken by trained crew wearing self-contained breathing apparatus and other protective clothing.

7.3.2.6 A careful inspection for structural damage should be carried out after dealing with spillages of substances corrosive to steel and cryogenic liquids.

#### 7.8.3 Special provisions for incidents involving infectious substances

7.8.3.1 If any person responsible for the transport or opening of packages containing infectious substances becomes aware of damage to or leakage from such packages, he should:

- .1 avoid handling the package or keep handling to a minimum;
- .2 inspect adjacent packages for contamination and put aside any that have been contaminated;
- .3 inform the appropriate public health authority or veterinary authority, and provide information on any other countries of transit where persons may have been exposed to danger; and
- .4 notify the consignor and/or the consignee.

### 7.8.3.2 Decontamination

A cargo transport unit, a bulk container or a cargo space of a ship, which has been used to transport infectious substances, shall be inspected for release of the substance before re-use. If infectious substances were released during transport, the cargo transport unit, the bulk container or the cargo space of a ship shall be decontaminated before it is re-used. Decontamination may be achieved by any means which effectively inactivates the infectious substance released.

## 7.8.4 Special provisions for incidents involving radioactive material

7.8.4.1 If it is evident that a package is damaged or leaking, or if it is suspected that the package may have leaked or been damaged, access to the package should be restricted and a qualified person should, as soon as possible, assess the extent of contamination and the resultant dose rate of the package. The scope of the assessment should include the package, the conveyance, the adjacent loading and unloading areas, and, if necessary, all other material which has been transported in the conveyance. When necessary, additional steps for the protection of people, property and the environment, in accordance with provisions established by the relevant competent authority, should be taken to overcome and minimize the consequences of such leakage or damage.

7.8.4.2 Packages damaged or leaking radioactive contents in excess of allowable limits for normal conditions of transport may be removed to an acceptable interim location under supervision, but should not be forwarded until repaired or reconditioned and decontaminated.

7.8.4.3 In the event of a nuclear or radiological emergency during the transport of radioactive material, provisions as established by relevant national and/or international organizations, should be observed to protect people, property and the environment. This includes arrangements for preparedness and response established in accordance with the national and/or international requirements and in a consistent and coordinated manner with the national and/or international emergency arrangements.

7.8.4.4 Attention is drawn to the latest versions of both *The EmS Guide: Revised Emergency Response Procedures for Ships Carrying Dangerous Goods* and the *Medical First Aid Guide for Use in Accidents Involving Dangerous Goods (MFAAG)*.

7.8.4.5 The arrangements for preparedness and response should be based on the graded approach and take into consideration the identified hazards and their potential consequences, including the formation of other dangerous substances that may result from the reaction between the contents of a consignment and the environment in the event of a nuclear or radiological emergency. Guidance for the establishment of such arrangements is contained in “Preparedness and Response for a Nuclear or Radiological Emergency”, IAEA Safety Standards Series No. GSR Part 7, IAEA, Vienna (2015); “Criteria for Use in Preparedness and Response for a Nuclear or Radiological Emergency”, IAEA Safety Standards Series No. GSG-2, IAEA, Vienna (2011); “Arrangements for Preparedness for a Nuclear or Radiological Emergency”, IAEA Safety Standards Series No. GS-G-2.1, IAEA, Vienna (2007), and “Arrangements for the Termination of a Nuclear or Radiological Emergency”, IAEA Safety Standards Series No. GSG-11, IAEA, Vienna (2018).

7.8.4.6 In the event of a package containing radioactive material suffering from breakage or leakage while the ship is in port, the port authorities should be informed and advice obtained from them or from the competent authority.\* Procedures have been drawn up in many countries for summoning radiological assistance in any such emergency.

## 7.8.5 General fire precautions

7.8.5.1 The prevention of fire in a cargo of dangerous goods is achieved by practising good seamanship, observing in particular the following precautions:

- .1 keep combustible material away from ignition sources;
- .2 protect a flammable substance by adequate packing;
- .3 reject damaged or leaking packages;
- .4 stow packages protected from accidental damage or heating;
- .5 segregate packages from substances liable to start or spread fire;
- .6 where appropriate and practicable, stow dangerous goods in an accessible position so that packages in the vicinity of a fire may be protected;

\* Reference is made to chapter 7.9 and the IAEA list of national competent authorities responsible for approvals and authorizations in respect of the transport of radioactive material. The list is updated annually.



**Part 7 – Provisions concerning transport operations**

---

- .7 enforce prohibition of smoking in dangerous areas and display clearly recognizable “NO SMOKING” notices or signs; and
- .8 the dangers from short-circuits, earth leakages or sparking will be apparent. Lighting and power cables and fittings should be maintained in good condition. Cables or equipment found to be unsafe should be disconnected. Where a bulkhead is required to be suitable for segregation purposes, cables and conduit penetrations of the decks and bulkheads should be sealed against the passage of gas and vapours.

When stowing dangerous goods on deck, the position and design of auxiliary machinery, electrical equipment and cable runs should be considered in order to avoid sources of ignition.

- 7.8.5.2 Fire precautions applying to individual classes, and where necessary to individual substances, are recommended in 7.8.2 and 7.8.6 to 7.8.9 and in the Dangerous Goods List.

**7.8.6 Special fire precautions for class 1**

- 7.8.6.1 The greatest risk in the handling and transport of goods of class 1 is that of fire from a source external to the goods, and it is vital that any fire should be detected and extinguished before it can reach such goods. Consequently, it is essential that fire precautions, fire-fighting measures and equipment are of a high standard and ready for immediate application and use.

- 7.8.6.2 Compartments containing goods of class 1 and adjacent cargo spaces should be provided with a fire-detection system. If such spaces are not protected by a fixed fire-extinguishing system, they should be accessible for fire-fighting operations.

- 7.8.6.3 No repair work should be carried out in a compartment containing goods of class 1. Special care should be exercised in carrying out repairs in any adjacent space. No welding, burning, cutting, or riveting operations involving the use of fire, flame, spark, or arc-producing equipment should be carried out in any space other than machinery spaces and workshops where fire-extinguishing arrangements are available, except in any emergency and, if in port, with prior authorization of the port authority.

**7.8.7 Special fire precautions for class 2**

- 7.8.7.1 Effective ventilation should be provided to remove any leakage of gas from within the cargo space or spaces, bearing in mind that some gases are heavier than air and may accumulate in dangerous concentrations in the lower part of the ship.

- 7.8.7.2 Measures should be taken to prevent leaking gases from penetrating into any other part of the ship.

- 7.8.7.3 If there is any reason to suspect leakage of a gas, entry into cargo spaces or other enclosed spaces should not be permitted until the master or responsible officer has taken all safety considerations into account and is satisfied that it is safe to do so. Emergency entry under other circumstances should only be undertaken by trained crew wearing self-contained breathing apparatus, and protective clothing when recommended, and always under the supervision of a responsible officer.

- 7.8.7.4 Leakage from pressure receptacles containing flammable gases may give rise to explosive mixtures with air. Such mixtures, if ignited, may result in explosion and fire.

**7.8.8 Special fire precautions for class 3**

- 7.8.8.1 Flammable liquids give off flammable vapours which, especially in an enclosed space, form explosive mixtures with air. Such vapours, if ignited, may cause a “flashback” to the place in which the substances are stowed. Due regard should be paid to the provision of adequate ventilation to prevent accumulation of vapours.

**7.8.9 Special fire precautions and fire fighting for class 7**

- 7.8.9.1 The radioactive contents of Excepted, Industrial, and Type A packages are so restricted that, in the event of an accident and damage to the package, there is a high probability that any material released, or shielding efficiency lost, would not give rise to such radiological hazard as to hamper fire-fighting or rescue operations.

- 7.8.9.2 Type B(U) packages, Type B(M) packages and Type C packages are designed to be strong enough to withstand severe fire without significant loss of contents or dangerous loss of radiation shielding.

## Chapter 7.9

### *Exemptions, approvals and certificates*

#### 7.9.1 Exemptions

**Note 1** The provisions of this section do not apply to exemptions mentioned in chapters 1 to 7.8 of this Code and to approvals (including permits, authorizations or agreements) and certificates which are referred to in chapters 1 to 7.8 of this Code. For the said approvals and certificates, see 7.9.2.

**Note 2** The provisions of this section do not apply to class 7. For consignments of radioactive material for which conformity with any provision of this Code applicable to class 7 is impracticable, refer to 1.5.4.

7.9.1.1 Where this Code requires that a particular provision for the transport of dangerous goods shall be complied with, a competent authority or competent authorities (port State of departure, port State of arrival or flag State) may authorize any other provision by exemption if satisfied that such provision is at least as effective and safe as that required by this Code. Acceptance of an exemption authorized under this section by a competent authority not party to it is subject to the discretion of that competent authority. Accordingly, prior to any shipment covered by the exemption, the recipient of the exemption shall notify other competent authorities concerned.

7.9.1.2 Competent authority or competent authorities which have taken the initiative with respect to the exemption:

- .1 shall send a copy of such exemption to the International Maritime Organization which shall bring it to the attention of the Contracting Parties to SOLAS and/or MARPOL, as appropriate, and
- .2 if appropriate, take action to amend the IMDG Code to include the provisions covered by the exemption.

7.9.1.3 The period of validity of the exemption shall be not more than five years from the date of authorization. An exemption that is not covered under 7.9.1.2.2 may be renewed in accordance with the provisions of this section.

7.9.1.4 A copy of the exemption shall accompany each consignment when offered to the carrier for transport under the terms of the exemption. A copy of the exemption or an electronic copy thereof shall be maintained on board each ship transporting dangerous goods in accordance with the exemption, as appropriate.

#### 7.9.2 Approvals (including permits, authorizations or agreements) and certificates

7.9.2.1 Approvals, including permits, authorizations or agreements, and certificates referred to in chapters 1 to 7.8 of this Code and issued by the competent authority (authorities when the Code requires a multilateral approval) or a body authorized by that competent authority (e.g. approvals for alternative packaging in 4.1.3.7, approval for segregation as in 7.3.4.1 or certificates for portable tanks in 6.7.2.18.1) shall be recognized, as appropriate:

- .1 by other contracting parties to SOLAS if they comply with the requirements of the *International Convention for the Safety of Life at Sea, 1974* (SOLAS), as amended; and/or
- .2 by other contracting parties to MARPOL if they comply with the requirements of the *International Convention for the Prevention of Pollution from Ships, 1973*, as modified by the Protocol of 1978 relating thereto (MARPOL, Annex III), as amended.

#### 7.9.3 Contact information for the main designated national competent authorities

Contact information for the main designated national competent authorities concerned is reproduced in this paragraph and obtained from the GISIS Module on Contact Points.\*

\* Member States are invited to access GISIS in order to update their corresponding main designated national competent authorities' contact information through their GISIS Account Managers. Public access to GISIS Module of Contact Points, in order to electronically obtain the most updated contact information, is provided through the following link: <https://gisis.imo.org/Public/>.

Part 7 – Provisions concerning transport operations

| Country                                   | Contact information for the main designated national competent authority  |
|---|---|
| <b>ALBANIA</b>                            | <p>Capt. Elmira Xhafa<br/>Dangerous Goods Management Office/inspector<br/>General Maritime Directorate<br/>(Ministry of Infrastructure and Energy)<br/>Lagja No. 1<br/>Rruga “Taulantia”, Porti Detar Durres<br/>Durres<br/>2001<br/>ALBANIA<br/>Telephone: +355 675444852<br/>Email: elmira.xhafa@dpdetare.gov.al<br/>Website: http://www.dpdetare.gov.al</p>  |
| <b>ALGERIA</b>                            | <p>Mrs. Mokdad Dounia<br/>Merchant Marine and Ports Director<br/>Ministry of Transports<br/>1, Chemin Ibn Badis El Mouiz (ex Poirson)<br/>El Biar<br/>Alger<br/>16000<br/>ALGERIA<br/>Telephone: +213 (0) 23 05 93 63<br/>Telefax: +213 (0) 23 05 93 19<br/>Email: cmd8266@yahoo.com<br/>damokdad@mtpt.gov.dz<br/>Website: https://www.mtp.gov.dz</p>   |
| <b>ANGOLA</b>                             | <p>Marine Safety, Shipping and Ports<br/>National Directorate of Merchant<br/>Marine and Ports<br/>Rua Rainha Ginga 74<br/>Andar, Luanda<br/>ANGOLA<br/>Telephone: +244 239 0034<br/>+244 239 79845<br/>+244 924 39 336<br/>Telefax: +244 231 037<br/>Email: ispscode_angola@snet.co.ao</p>   |
| <b>ARGENTINA</b>                          | <p>Departamento de protección ambiental y mercancías peligrosas<br/>Prefectura Naval Argentina<br/>Dirección de protección ambiental<br/>División de mercancías y residuos peligrosos<br/>Avda. Eduardo Madero 235<br/>4º piso, oficinas 4.36 y 4.37<br/>Buenos Aires<br/>C1106ACC<br/>ARGENTINA<br/>Telephone: +54 11 4318 7669<br/>Telefax: +54 11 4318 7474<br/>Email: dpma-mp@prefectura naval.gov.ar</p> |
| <b>ARUBA (KINGDOM OF THE NETHERLANDS)</b> | <p>Mr. Rudy Beaujon<br/>Directorate of Shipping Aruba (DSA)<br/>Ministry of Integrity, Nature, Transport, and Elderly Care (MINTE)<br/>Italiestraat 20<br/>Oranjestad<br/>ARUBA (KINGDOM OF THE NETHERLANDS)<br/>Telephone: +297 592 8799<br/>Email: r.beaujon@dsa.aw</p>   |

| Country           | Contact information for the main designated national competent authority  |
|-------------------|---|
| <b>AUSTRALIA</b>  | Head of Cargoes and Technical, Vessel Standards<br>Australian Maritime Safety Authority Standards<br>Australian Maritime Safety Authority<br>GPO Box 2181<br>Canberra<br>ACT 2601<br>AUSTRALIA<br>Telephone: +61 (0)2 6279 5070<br>Email: cargoca@amsa.gov.au<br>Website: https://www.amsa.gov.au   |
| <b>AUSTRIA</b>    | Transport of Dangerous Goods and Safe Containers<br>Federal Ministry for Transport, Innovation and Technology<br>Radetzkystaße 2<br>Wien<br>1030<br>AUSTRIA<br>Telephone: +43 1 71162 65 5771<br>Telefax: +43 1 71162 65 5725<br>Email: st3@bmvit.gv.at<br>Website: http://www.bmvit.gv.at  |
| <b>AZERBAIJAN</b> | State Agency for Safe Working in Industry and Mountain-Mine Control<br>Ministry of Emergency Situations of the Republic of Azerbaijan<br>26 Najafgulu Rafiyev Street<br>Baku<br>Khatai Region<br>AZ 1025<br>AZERBAIJAN<br>Telephone: +994 12 512-25-01<br>Telefax: +994 12 512-15-01<br>Email: dag-meden@fhn.gov.az   |
| <b>BAHAMAS</b>    | The Bahamas Maritime Authority<br>Inspections and Surveys Department<br>120 Old Broad Street<br>London<br>EC2N 1AR<br>UNITED KINGDOM<br>Telephone: +44 20 7562 1300<br>Email: tech@bahamasmaritime.com<br><br>The Bahamas Maritime Authority<br>Bahamas Maritime Authority<br>120 Old Broad Street<br>London<br>EC2N 1AR<br>UNITED KINGDOM<br>Telephone: +44 (0)20 7562 1300<br>Emergency: +44 (0)7977 471 220<br>Email: tech@bahamasmaritime.com |
| <b>BANGLADESH</b> | Department of Shipping<br>141-143, Motijheel Commercial Area<br>BIWTA Bhaban (8th Floor)<br>Dhaka-1000<br>BANGLADESH<br>Telephone: +880 2 9555128<br>Fax: +880 2 7168363<br>Email: dosdgd@bttb.net.bd   |

Part 7 – Provisions concerning transport operations

| Country  | Contact information for the main designated national competent authority  |
|--|---|
| <b>BARBADOS</b>  | Miss Jacqueline Blackman<br>Director of Maritime Affairs<br>Ministry of Maritime Affairs and the Blue Economy<br>Civil Aviation Department Building<br>Charnocks<br>Christ Church<br>BARBADOS<br>Telephone: +1 246 535 200<br>Email: jacqueline.blackman@barbados.gov.bb  |
| <b>BELGIUM</b>   | Directorate General Shipping - Antwerp office<br>Federale Overheidsdienst Mobiliteit en Vervoer<br>Scheepvaartcontrole<br>Posthoflei 3<br>Antwerpen-Berchem<br>2000<br>BELGIUM<br>Telefax: +32 3 229 0031<br>Email: hazmat.mar@mobiliteit.fgov.be   |
| <b>BELIZE</b>  | Ports Commissioner/Harbour Master<br>120 Corner North Front and Pickstock Street<br>Belize City<br>BELIZE<br>Telephone: +501 223 0752<br>+501 223 0762<br>+501 223 0743<br>Telefax: +501 223 0433<br>Website: <a href="http://www.portauthority.bz">http://www.portauthority.bz</a>   |
| <b>BERMUDA<br/>(UNITED KINGDOM)</b>                    | Bermuda Shipping and Maritime Authority<br>Mr. Taran Card<br>PO Box Hm1628<br>Hamilton HM GX<br>BERMUDA (UNITED KINGDOM)<br>Telephone: +1 441 295 7251<br>Telefax: +1 441 295 3718<br>Email: survey@bermudashipping.bm  |
| <b>BRAZIL</b>  | Diretoria de Portos e Costas (DPC-20)<br>Rua Teófilo Otoni No. 04<br>Centro<br>Rio de Janeiro<br>CEP 20090-070<br>BRAZIL<br>Telephone: +55 21 2104 5203<br>Telefax: +55 21 2104 5202<br>Email: dpc.secom@marinha.mil.br   |
| <b>BRITISH VIRGIN<br/>ISLANDS<br/>(UNITED KINGDOM)</b> | Virgin Islands Shipping Registry<br>Mr. John Samuel<br>Director of Shipping<br>1st floor Ritter House<br>Wickhams Cay II<br>Road Town<br>Tortola<br>VG1110<br>BRITISH VIRGIN ISLANDS (UNITED KINGDOM)<br>Telephone: +1(284)4682902<br>+1(284)4689646<br>Email: vishipping@gov.vg<br>jsamuel@gov.vg<br>vishipping@bvimaritime.vg<br>john.samuel@bvimaritime.vg<br>Website: <a href="https://bvimaritime.vg/">https://bvimaritime.vg/</a> |

| Country    | Contact information for the main designated national competent authority   |
|------------|--|
| BULGARIA   | <p>Bulgarian Maritime Administration<br/>9 Dyakon Ignatii Str.<br/>SOFIA<br/>1000<br/>BULGARIA<br/>Telephone: +359 700 10 145<br/>Email: bma@marad.bg<br/>Website: http://www.marad.bg/</p> <p>DIRECTORATE “MARITIME ADMINISTRATION” – VARNA<br/>Bulgarian Maritime Administration<br/>5 Primorski Bulv.,<br/>Varna<br/>9000<br/>BULGARIA<br/>Telephone: +359 700 10 145<br/>Email: hm_vn@marad.bg</p> |
| CABO VERDE | <p>Capt. Aguinaldo Lima<br/>Capitania dos Portos<br/>Instituto Marítimo Portuário – IMP // CV MarAd<br/>Rua Patrice Lumumba<br/>Edifício ex. ACIAB<br/>Mindelo<br/>Ilha de S. Vicente<br/>P.O. Box. nr. 7<br/>CABO VERDE<br/>Telephone: +238 2324342<br/>Telefax: +238 2324343<br/>Email: aguinaldo.lima@imp.cv<br/>Website: http://www.imp.cv</p>   |
| CAMEROON   | <p>Mrs. Onana Claire<br/>Director of Shippers’ Assistance<br/>Cameroon National Shippers’ Council<br/>P.O. Box 1588<br/>Douala<br/>Littoral<br/>00000<br/>CAMEROON<br/>Telephone: +237 674 05 77 77<br/>Email: c.onana@cnc-cm.org</p>  |
| CANADA     | <p>Chair of the Marine Technical Review Board<br/>Transport Canada, Marine Safety and Security<br/>Tower C, Place de Ville<br/>330 Sparks Street, 10th Floor<br/>Ottawa, Ontario<br/>K1A 0N5<br/>CANADA<br/>Telephone: +1 613 991 3143<br/>Telefax: +1 613 993 8196<br/>Website: http://www.tc.gc.ca</p>   |

Part 7 – Provisions concerning transport operations

| Country                                   | Contact information for the main designated national competent authority   |
|---|--|
| <b>CANADA</b><br>(continued)              | Director Regulatory Affairs<br>Transport Dangerous Goods Directorate<br>Tower C, Place de Ville<br>330 Sparks Street, 9th Floor<br>Ottawa,<br>Ontario<br>K1A 0N5<br>CANADA<br>Telephone: +1 613 998 0519<br>+1 613 990 1163<br>+1 613 993 5266<br>Telefax: +1 613 993 5925   |
| <b>CAYMAN ISLANDS</b><br>(UNITED KINGDOM) | Issue of Wreck Removal Convention certificates<br>Duty Officer<br>Maritime Authority of the Cayman Islands<br>1st Floor, Vanburgh House<br>Grange Drive<br>Hedge End<br>Southampton<br>SO30 2AF<br>UNITED KINGDOM<br>Telephone: +44 (0) 1489 799 203<br>Telefax: +44 (0) 1489 799 204<br>Email: reporting@cishipping.com<br>Website: https://www.cishipping.com        |
| <b>CHILE</b>                              | Dirección General del Territorio<br>Marítimo y de Marina Mercante<br>Captain (R) Manuel Bolbarán Santander<br>Departamento Prevención de Riesgos Nacional<br>Subida Cementerio N° 300/Playa Ancha<br>Valparaíso<br>5ª Región<br>2520000<br>CHILE<br>Telephone: +56 32 2208607<br>+56 32 2208656<br>Email: mbolbaran@directemar.cl<br>Website: http://www.directemar.cl |
| <b>CHINA</b>                              | Maritime Safety Administration of the People's Republic of China<br>11 Jianguomen Nei Avenue<br>Beijing<br>100736<br>CHINA<br>Telephone: +86 10 6529 2245<br>+86 10 6529 2588<br>Fax: +86 10 6529 2218<br>Telex: 222258 CMSAR CN   |
| <b>COMOROS</b>                            | Ministre d'État<br>Ministère du développement, des infrastructures, des postes<br>et des télécommunications et des transports<br>Moroni<br>COMORES<br>Telephone: +269 744 287<br>+269 735 794<br>+269 340 248<br>Telefax: +269 734 241<br>+269 834 241<br>Email: houmedms@yahoo.fr   |



| Country    | Contact information for the main designated national competent authority  |
|------------|---|
| COSTA RICA | <p>Mr. Nelson Soto Corrales<br/>Navigation and Safety Director<br/>Ministry of Public Works and Transportation<br/>Ministerio de Obras Públicas y Transportes<br/>Plaza González Víquez, edificio anexo al plantel principal,<br/>oficina número 64<br/>Calle 9, entre avenidas 20 y 22<br/>República Panamá<br/>San José<br/>10104<br/>COSTA RICA<br/>Telephone: +505 22335022<br/>Telefax: +506 22336510<br/>Email: nelson.soto@mopt.go.cr<br/>Website: https://www.mopt.go.cr/</p>   |
| CROATIA    | <p>Cargo Superintendence and Testing Services Adriainspekt<br/>Ciottina 17/b<br/>Rijeka<br/>51000<br/>CROATIA<br/>Telephone: +385 51 356 080<br/>Telefax: +385 51 356 090<br/>Email: ai@adriainspekt.hr<br/>Website: http://www.adriainspekt.hr</p> <p>Croatian Register of Shipping (CRS)<br/>Marasovićeve 67<br/>P.O. Box 187<br/>Split<br/>21000<br/>CROATIA<br/>Telephone: +385 21 408 111<br/>+385 21 408 154<br/>Telefax: +385 21 358 159<br/>+385 51 356 090<br/>Email: dir@crs.hr</p> <p>Marine Safety Directorate<br/>Ministry of Maritime Affairs, Transport and Infrastructure<br/>MRCC Rijeka<br/>Senjsko pristaniste 3<br/>Rijeka<br/>51000<br/>CROATIA<br/>Telephone: +385 1 6169 250<br/>Telefax: +385 51 312 254<br/>Email: mrcc@pomorstvo.hr</p> |
| CUBA       | <p>Mr. Enrique Pozo<br/>General Manager of Maritime Safety<br/>Maritime Safety Directorate<br/>Dirección de Seguridad Marítima Ministerio del Transporte<br/>Avda. Rancho Boyeros y Tulipán, Plaza<br/>Ciudad de La Habana<br/>10600<br/>CUBA<br/>Telephone: +53 78812191<br/>+53 78812195<br/>+53 53853840<br/>Telefax: +53 78811514<br/>Email: pozo.sm@amc.transnet.cu</p>  |

## Part 7 – Provisions concerning transport operations

| Country   | Contact information for the main designated national competent authority  |
|---|---|
| <b>CUBA</b><br><i>(continued)</i>                     | Dirección de Seguridad e Inspección Marítima<br>Ministerio del Transporte<br>Boyeros y Tulipán Plaza, 4º. piso<br>Ciudad de la Habana<br>CUBA<br>Telephone: +53 7 816607<br>+53 7 819498<br>Telex: 511135 MITRANS CU<br>Telefax: +53 7 8811514<br>Email: dsim@mitrans.transnet.cu   |
| <b>CURAÇAO</b><br><b>(KINGDOM OF THE NETHERLANDS)</b> | Capt. Marlon La Roche<br>Harbour Master Curacao<br>Motetwerf<br>P.O. Box 689<br>Willemstad<br>CURAÇAO (KINGDOM OF THE NETHERLANDS)<br>Telephone: +599 9434 5971<br>+599 9690 3346<br>Email: m.laroche@curports.com  |
| <b>CYPRUS</b>   | Shipping Deputy Ministry to the President<br>Kylinis Street, Mesa Geitonia,<br>CY-4007 Lemesos<br>P.O. Box 56193, CY-3305 Lemesos<br>Lemesos<br>CYPRUS<br>Telephone: +357 25 848100<br>Telefax: +357 25 848200<br>Email: maritimeadmin@dms.gov.cy   |
| <b>CZECHIA</b>  | Československý Lloyd, spol.s r.o.<br>Pobřežní 620/3<br>Praha 8<br>186 00<br>CZECHIA<br>Telephone: +420 777 767 701<br>+420 777 767 714<br>Email: info@cslloyd.cz<br>objednavky@cslloyd.cz<br>Website: <a href="http://www.cslloyd.cz/en/">http://www.cslloyd.cz/en/</a><br><br><i>Czech office for weapon and ammunition testing</i><br>Český úřad pro zkoušení zbraní a střeliva<br>Jilmová 759/12<br>Praha 3<br>130 00<br>CZECHIA<br>Telephone: +420 284 081 831<br>Email: info@cuzzs.cz<br><br>CIMTO, s.r.o.<br>Líšeňská 2657/33a<br>Brno<br>636 00<br>CZECHIA<br>Telephone: +420 241 471 069<br>+420 728 310 276<br>Email: cimto@cimto.cz<br>Website: <a href="https://www.cimto.cz">https://www.cimto.cz</a> |

| Country   | Contact information for the main designated national competent authority  |
|---|---|
| <p><b>CZECHIA</b><br/><i>(continued)</i></p>                | <p>IMET, s.r.o.<br/>Kamýcká 234<br/>Praha 6 - Sedlec<br/>160 00<br/>CZECHIA<br/>Telephone: +420 220 922 085<br/>+420 220 922 082<br/>Email: imet@imet.cz<br/>Website: http://www.imet.cz</p> <p><i>Department of Rail and Waterborne Transport Maritime Division</i><br/>Ministry of Transport of the Czech Republic<br/>Nábr. L. Svobody 1222/12<br/>Praha 1<br/>110 15<br/>CZECHIA<br/>Telephone: +420 225 131 110<br/>+420 225 131 215<br/>+420 225 131 343<br/>Email: sekretariat.130@mdcr.cz</p> <p>RAILTEST, a.s.<br/>Dělnická 1408/29<br/>Děčín<br/>405 02<br/>CZECHIA<br/>Telephone: +420 412 598 239<br/>+420 731 622 065<br/>Email: info@railtest.cz<br/>Website: https://www.railtest.cz</p> <p>TUV SUD Czech s.r.o.<br/>Novodvorská 994/138<br/>Praha 4<br/>142 21<br/>CZECHIA<br/>Telephone: +420 844 888 783<br/>Email: info@tuv-sud.cz<br/>Website: https://www.tuv-sud.cz</p> |
| <p><b>DEMOCRATIC<br/>PEOPLE'S REPUBLIC<br/>OF KOREA</b></p> | <p>Maritime Administration DPR Korea<br/>Ryonhwa-dong No.2, Central District<br/>P.O. Box 416<br/>Pyongyang<br/>DEMOCRATIC PEOPLE'S REPUBLIC OF KOREA<br/>Telephone: +850 2 18111<br/>Telefax: +850 2 381 4410<br/>Email: mab@silibank.net.kp</p>   |
| <p><b>DENMARK</b></p>                                       | <p>Danish Maritime Authority<br/>Carl Jacobsens Vei 31<br/>Valby<br/>2500<br/>DENMARK<br/>Telephone: +45 72 19 60 00<br/>Fax: +45 72 19 60 01<br/>Email: SFS@dma.dk</p> <p><i>Packing, Testing and Certification Institute</i><br/>Emballage og Transportinstituttet (E.T.I.)<br/>Dansk Teknologisk Institut<br/>Gregersensvej<br/>Tåstrup<br/>2630<br/>DENMARK</p>   |

## Part 7 – Provisions concerning transport operations

| Country         | Contact information for the main designated national competent authority   |
|-----------------|--|
| <b>DJIBOUTI</b> | Director of Maritime Affairs<br>Ministère de l'équipement et des transports<br>P.O. Box 59<br>DJIBOUTI<br>Telephone: +253 357 913<br>Telefax: +253 351 538<br>+253 253 931<br>+253 355 879   |
| <b>ECUADOR</b>  | LCDR Freddy Espinoza<br>Deputy Director of Environmental Management<br>Dirección Nacional De Los Espacios Acuáticos<br>Elizalde 101 y Malecón<br>Guayaquil<br>Guayas<br>090307<br>ECUADOR<br>Telephone: +593 42320400 ext. 37206<br>0990984055<br>Email: fespinozah@armada.mil.ec<br>fespinozah001@gmail.com<br><br>Ing. Aníbal Aroca<br>Experto en infraestructura portuaria<br>Subsecretaría de puertos y transporte marítimo y fluvial (SPTMF)<br>Cdla. Los Ceibos – Av. Del Bombero y Leopoldo<br>Carrera – Edif. “Grace” EP-Petroecuador - 1 <sup>er</sup> piso<br>Guayaquil<br>Guayas<br>ECUADOR<br>Telephone: +593 42592080<br>Email: aaroca@mtop.gob.ec<br><br>Ing. Richard Villacís<br>Jefe de Contaminación<br>Subsecretaría de puertos y transporte marítimo y fluvial (SPTMF)<br>Av. del Bombero y Leopoldo Carrera - Cdla. Ceibos. Edif.<br>EP-Petroecuador. 1 <sup>er</sup> piso<br>Guayaquil<br>ECUADOR<br>Telephone: +593 62723008<br>Email: rvillacis@mtop.gob.ec<br><br>Mgs. Xavier Medina<br>Superintendente<br>Superintendencia del Terminal Petrolero de “El Salitral” (SUINSA)<br>Terminal Petrolero de el Salitral<br>Guayaquil<br>ECUADOR<br>Telephone: +593 45504901<br>Telefax: +593 42504901 Ext. 102 / 109<br>Email: suinsa_operaciones@mtop.gob.ec<br>suinsa_radio@mtop.gob.ec<br>xmedina@mtop.gob.ec |

| Country                              | Contact information for the main designated national competent authority  |
|--------------------------------------|---|
| <b>ECUADOR</b><br><i>(continued)</i> | Ing. Henry Romero<br>Superintendente<br>Superintendencia del Terminal<br>Petrolero de la Libertad (SUINLI)<br>Terminal Petrolero de la Libertad<br>La Libertad<br>ECUADOR<br>Telephone: +592342785785<br>Telefax: +59342785781<br>Email: <a href="mailto:suinli_operaciones@mtop.gob.ec">suinli_operaciones@mtop.gob.ec</a><br><a href="mailto:suinli_radio@mtop.gob.ec">suinli_radio@mtop.gob.ec</a><br><a href="mailto:hromero@mtop.gob.ec">hromero@mtop.gob.ec</a> |
| <b>EL SALVADOR</b>                   | Capt. Guillermo Jiménez<br>Executive Director<br>Maritime Port Authority (AMP)<br>Col. San Benito y Calle 2, entre calles Loma Linda y La Mascota,<br>casa 127<br>San Salvador<br>EL SALVADOR<br>Telephone: +503 25919007<br>Email: <a href="mailto:gjimenez@amp.gob.sv">gjimenez@amp.gob.sv</a><br>Website: <a href="https://www.amp.gob.sv">https://www.amp.gob.sv</a>  |
| <b>EQUATORIAL GUINEA</b>             | Mr. Javier Ondo Mba Eyang<br>Director General de Registros de Buques y Empresas Marítimas<br>Ministro de Transportes, Correos y Telecomunicaciones<br>Malabo<br>EQUATORIAL GUINEA<br>Telephone: +(240)222277405<br>Email: <a href="mailto:dgbuquesyem@gob.gq">dgbuquesyem@gob.gq</a><br>Website: <a href="https://mintct.gob.gq/">https://mintct.gob.gq/</a>  |
| <b>ERITREA</b>                       | Director General<br>Department of Maritime Transport<br>Ministry of Transport and Communications<br>ERITREA<br>Telephone: +291 1 121 317<br>+291 1 189 156<br>+291 1 185 251<br>Fax: +291 1 184 690<br>+291 1 186 541<br>Email: <a href="mailto:motcrez@eol.com.er">motcrez@eol.com.er</a>  |
| <b>ESTONIA</b>                       | Certificate and incidents<br>Maritime Safety and Supervision Department<br>Estonian Transport Administration<br>Valge 4<br>Tallinn<br>11413<br>ESTONIA<br>Telephone: +372 6201 200<br>+372 5302 4258<br>Email: <a href="mailto:info@transpordiamet.ee">info@transpordiamet.ee</a>   |

Part 7 – Provisions concerning transport operations

| Country                | Contact information for the main designated national competent authority   |
|------------------------|--|
| <b>ETHIOPIA</b>        | <p>Mr. Mekonnen Abera Tadele<br/>Director General<br/>Ethiopian Maritime Affairs Authority<br/>Tadesse Tefera Bldg, 5th floor<br/>In front of hotel De' Afrique, near Mexico square<br/>Lideta subcity<br/>Addis Ababa<br/>Ethiopia<br/>1861<br/>ETHIOPIA<br/>Telephone: +25115503638<br/>+25115503640<br/>+251911513073<br/>+251911231115<br/>+251115588237<br/>Telefax: +25110115503960<br/>Email: mekonnenab@yahoo.com<br/>maraddirector@etmaritime.com<br/>getinet.esl@gmail.com<br/>maritimeadministration@maritimeaff.gov.et<br/>Website: https://www.etmaritime.com</p> |
| <b>FAROES, DENMARK</b> | <p>Sjóvinnustýrið<br/>Faroese Maritime Authority<br/>Bókbindaragøta 8<br/>Tórshavn<br/>FO-100<br/>FAROES, DENMARK<br/>Telephone: +298 35 56 00<br/>Email: fma@fma.fo<br/>Website: https://www.fma.fo</p>   |
| <b>FINLAND</b>         | <p>Safety Technology Authority (TUKES)<br/>P.O. Box 123<br/>Helsinki<br/>00181<br/>FINLAND<br/>Telephone: +358 96 1671<br/>Telefax: +358 96 1674 66<br/>Email: kirjaamo@tukes.fi</p> <p>Transport Safety Agency Trafi<br/>P.O. Box 320<br/>Helsinki<br/>00101<br/>FINLAND<br/>Telephone: +358 29534 5000<br/>Telefax: +358 29 534 5095<br/>Email: kirjaamo@trafi.fi</p>  |
| <b>FRANCE</b>          | <p>Ministère de la transition écologique<br/>Adjoint au Chef de la Mission Transport de matières dangereuses<br/>MTE – DGPR – Mission Transport de matières dangereuses (MTMD)<br/>Paris La Défense Cedex 92055<br/>FRANCE<br/>Telephone: +33 1 40 81 14 96<br/>Telefax: +33 1 40 81 86 41<br/>Email: pierre.dufour@developpement-durable.gouv.fr</p>  |

| Country                             | Contact information for the main designated national competent authority  |
|-------------------------------------|---|
| <b>FRANCE</b><br><i>(continued)</i> | Autorité de Sûreté Nucléaire (ASN)<br>15, rue Louis-Lejeune<br>CS 70013<br>F-92541 Montrouge Cedex<br>FRANCE<br>Telephone: +33 (0)1 46 16 41 09<br>Email: dts-transport@asn.fr  |
| <b>GAMBIA</b>                       | The Director General<br>Gambia Port Authority<br>P.O. Box 617<br>Banjul<br>GAMBIA<br>Telephone: +220 4 227 270<br>+220 4 227 260<br>+220 4 227 266<br>Telefax: +220 4 227 268   |
| <b>GEORGIA</b>                      | State Ships' Registry and Flag State Implementation Department/<br>Seafarers' Department<br>Maritime Transport Agency<br>23 E. Ninoshvili Str.<br>Batumi<br>6000<br>GEORGIA<br>Telephone: +995 4222 7 49 25<br>Telefax: +995 4222 7 39 29<br>Email: fsi@mta.gov.ge<br>stcw@mta.gov.ge<br><br>Maritime Search and Rescue Centre<br>Maritime Transport Agency<br>50 Baku str.<br>Batumi<br>6000<br>GEORGIA<br>Telephone: +995 4222 7 49 25<br>+995 5992 9 37 36<br>Telefax: +995 4222 7 39 29<br>Email: mrcc@mta.gov.ge<br>Website: http://www.mta.gov.ge |
| <b>GERMANY</b>                      | Ms. Korinna Rakowski<br>Division G 16 – Transport of Dangerous Goods<br>BAM Bundestanalt für Materialforschung und -Prüfung<br>Department 3 - Containment Systems for Dangerous Goods<br>(Packagings, Tanks, Container)<br>Unter den Eichen 44-46<br>Berlin<br>12203<br>GERMANY<br>Telephone: +49 30 8104 0 or extension<br>+49 30 8104 1310<br>Email: seeverkehr@bam.de<br>thomas.goedecke@bam.de<br>Website: https://www.bam.de   |



Part 7 – Provisions concerning transport operations

| Country                               | Contact information for the main designated national competent authority   |
|---------------------------------------|--|
| <p><b>GERMANY</b><br/>(continued)</p> | <p>Federal Ministry for Digital and Transport<br/>Robert-Schuman-Platz 1<br/>Bonn<br/>53175<br/>GERMANY<br/>Telephone: +49 228 3000 or 300 extension<br/>+49 228 300 2471<br/>Telefax: +49 228 300 807 2471<br/>Email: ref-G16@bmdv.bund.de<br/>Website: <a href="https://www.bmvi.de/SharedDocs/DE/Artikel/G/Gefahrgut/gefahrgut-recht-vorschriften-seeschifffahrt.html">https://www.bmvi.de/SharedDocs/DE/Artikel/G/Gefahrgut/gefahrgut-recht-vorschriften-seeschifffahrt.html</a></p>   |
| <p><b>GHANA</b></p>                   | <p>Capt. Abdul Nasir Inusah<br/>Technical Services<br/>Division/Director<br/>Ministry of Transport/Ghana<br/>Maritime Authority<br/>P O Box Ministries 34<br/>Ridge<br/>Accra<br/>233<br/>GHANA<br/>Telephone: +233 302677702<br/>+233 244037367<br/>Telefax: +233 302677702<br/>Email: Inusah.a.nasir@ghanamaritime.org<br/>info@ghanamaritime.org<br/>Website: <a href="https://www.ghanamaritime.org">https://www.ghanamaritime.org</a></p> <p>Mr. Thomas Kofi Alonsi<br/>Director General<br/>Ministry of Transport/Ghana Maritime Authority<br/>PMB 34<br/>Ministries Post Office<br/>Accra<br/>GHANA<br/>Telephone: +233 302 662122<br/>Telefax: +233 302 684392<br/>Email: thomas.k.alonsi@ghanamaritime.org<br/>info@ghanamaritime.org<br/>Website: <a href="https://www.ghanamaritime.org">https://www.ghanamaritime.org</a></p> <p>Capt. Francis K. Botse Micah<br/>Harbour Master, Port of Tema<br/>Ministry of Transport/Ghana Ports and Harbours Authority<br/>Port of Tema<br/>P.O. Box 150<br/>Tema<br/>Greater Accra<br/>GHANA<br/>Telephone: +233 244167488<br/>Telefax: +233 22202812<br/>Email: KMicah@ghanaports.gov.gh<br/>Website: <a href="https://www.ghanaports.gov.gh">https://www.ghanaports.gov.gh</a></p> |

| Country                               | Contact information for the main designated national competent authority  |
|---------------------------------------|---|
| <b>GIBRALTAR<br/>(UNITED KINGDOM)</b> | Survey Division<br>Gibraltar Maritime Administration<br>Watergate House<br>2/8 Casemates Square<br>GX11 1AA<br>GIBRALTAR (UNITED KINGDOM)<br>Telephone: +350 20046862<br>+350 56939000<br>Telefax: +350 20047770<br>Email: maritime.survey@gibraltar.gov.gi             |
| <b>GREECE</b>                         | Safety of Navigation Division<br>Ministry of Mercantile Marine<br>International Relations Department<br>150 Gr. Lambraki Av.<br>Piraeus<br>185 18<br>GREECE<br>Telephone: +301 41 91188<br>Telex: +212022, 212239 YEN GR<br>Telefax: +301 41 28150<br>Email: dan@yen.gr |
| <b>GUERNSEY<br/>(UNITED KINGDOM)</b>  | Mr. Jerome Davis<br>Head of Port Operations<br>Guernsey Ports<br>S Julians Emplacement<br>St Peter Port<br>GY1 3DL<br>GUERNSEY (UNITED KINGDOM)<br>Telephone: +44 1481705823<br>Email: jerome.davis@gov.gg<br>Website: http://www.harbours.gg                           |
| <b>GUINEA-BISSAU</b>                  | The Minister<br>Ministry of Transport & Communication<br>Avda. 3 de Agosto<br>Bissau<br>GUINEA-BISSAU<br>Telephone: +245 212 583<br>+245 211 308  |
| <b>GUYANA</b>                         | Stephen Thomas<br>Maritime Administration Department<br>Kingston<br>Top Floor<br>Fort Street<br>Georgetown<br>GUYANA<br>Telephone: +592 225 7330<br>+592 226 7842<br>Email: dg@marad.gov.gy<br>info@marad.gov.gy<br>Website: http://marad.gov.gy                        |

Part 7 – Provisions concerning transport operations

| Country                             | Contact information for the main designated national competent authority   |
|-------------------------------------|--|
| <b>GUYANA</b><br><i>(continued)</i> | Capt. Stephen Thomas<br>Director General<br>Maritime Administration Department<br>Battery Road & Fort Street<br>Kingston<br>Georgetown<br>GUYANA<br>Telephone: +592 225 7330<br>Email: dg@marad.gov.gy<br>stephenthomas@marad.gov.gy<br>info@marad.gov.gy  |
| <b>ICELAND</b>                      | Icelandic Transport Authority (ICETRA)<br>Armuli 2<br>108 Reykjavik<br>ICELAND<br>Telephone: +354 480 6000<br>Email: geirg@samgongustofa.is<br>samgongustofa@samgongustofa.is  |
| <b>INDIA</b>                        | Capt. K. P. Jayakumar<br>Nautical Advisor to the Government of India (I/c)<br>Directorate General of Shipping,<br>9th Floor Beta Building, i-Think Techno<br>Campus, Kanjurmarg (East),<br>Mumbai<br>Maharashtra<br>400 042<br>INDIA<br>Telephone: +91 2225752009<br>Telefax: +91 2225752032<br>Email: jayakumar-dgs@gov.in<br>Anish-dgs@gov.in<br>na-dgs@nic.in |
| <b>INDONESIA</b>                    | Director of Sea and Coast Guard<br>Directorate-General of Sea Transportation<br>Ministry of Transportation of the Republic of Indonesia<br>INDONESIA<br>Email: kplp_imdgcode@dephub.go.id<br>kplp_syahbandar@dephub.go.id  |
| <b>IRELAND</b>                      | Department of Transport<br>Marine Survey Office<br>The Chief Surveyor<br>Leeson Lane<br>Dublin 2<br>IRELAND<br>Telephone: +353 1 604 14 20<br>Telefax: +353 1 604 14 08<br>Email: mso@transport.ie   |
| <b>ISRAEL</b>                       | Mr. Yosef Yohana<br>Head, Shipping Inspectorate<br>Ministry of Transport, Administration of shipping & Ports<br>15A Pal-Yam St. PO. box 806<br>Haifa<br>31077<br>ISRAEL<br>Telephone: +97248632080<br>Email: yohanay@mot.gov.il  |

| Country | Contact information for the main designated national competent authority   |
|---------|--|
| ITALY   | <p>Lt. Cdr. (IT.C.G.) Francesco Foti<br/>Ufficio II - Merci Pericolose<br/>Comando Generale del Corpo delle Capitanerie di Porto<br/>Viale Dell'Arte, 16<br/>Roma<br/>00144<br/>ITALY</p> <p>Telephone: +39 06 5908 4267<br/>+39 06 5908 4652<br/>Telefax: +39 06 5908 4630<br/>Email: cgcp@pec.mit.gov.it<br/>segreteria.reparto6@mit.gov.it<br/>Website: http://www.guardiacostiera.gov.it/</p>  |
| JAMAICA | <p>The Bureau of Standards<br/>6 Winchester Road<br/>P.O. Box 113<br/>Kingston<br/>JAMAICA</p> <p>Telephone: +1 809 926 31407 or 3140/7<br/>Telex: 2291 STANBUR Jamaica</p> <p>The Maritime Authority of Jamaica<br/>4th Floor, Dyoll Building<br/>40 Knutsford Boulevard<br/>Kingston 5<br/>JAMAICA</p> <p>Telephone: +1 876 929 2201<br/>+1 876 754 7260/5<br/>Telex: +1 876 7256<br/>Email: maj@jamaicaships.com<br/>Website: http://www.jamaicaships.com</p> |
| JAPAN   | <p>Inspection and Measurement Division<br/>Maritime Bureau<br/>Ministry of Land, Infrastructure, Transport and Tourism<br/>2-1-3 Kasumigaseki, Chiyoda-ku<br/>Tokyo<br/>JAPAN</p> <p>Telephone: +81 3 5253 8639<br/>Telefax: +81 3 5253 1644<br/>Email: hqt-mrb_ksk@gxb.mlit.go.jp</p>   |
| KENYA   | <p>Mr. Robert Njue<br/>Director General<br/>Kenya Maritime Authority<br/>P. O Box 95076<br/>Mombasa<br/>80104<br/>KENYA</p> <p>Telephone: +254202381203<br/>+254733221322<br/>Email: INFO@KMA.GO.KE<br/>DG@KMA.GO.KE</p>   |
| KUWAIT  | <p>Capt. Bader Alanizy<br/>Director of Marine Operations<br/>Kuwait Port Authority<br/>K.P.A - Shuwaikh Port<br/>Jamal Abdullnaser Street<br/>P.O.BOX 3874 Safat<br/>13039<br/>KUWAIT</p> <p>Telefax: +965-24819714<br/>Email: info@kpa.gov.kw<br/>Website: http://kpa.gove.kw</p>   |

Part 7 – Provisions concerning transport operations

| Country          | Contact information for the main designated national competent authority   |
|------------------|--|
| <b>LATVIA</b>    | <p>American Bureau of Shipping<br/>Bureau Veritas<br/>Det Norske Veritas<br/>Lloyd's Register of Shipping<br/>Maritime Safety Department<br/>Maritime Administration of Latvia<br/>Trijādības iela 5<br/>LV-1048 Riga<br/>LATVIA<br/>Telephone: +371 670 62 177<br/>+371 670 62 142<br/>Telefax: +371 678 60 083<br/>Email: zane.paulovska@lja.lv<br/>lja@lja.lv<br/>Website: http://www.lja.lv</p> <p>MRCC Riga<br/>Meldru str. 5a<br/>LV-1015 Riga<br/>LATVIA<br/>Telephone: +371 67323103 (emergency)<br/>+371 29476101<br/>+371 67082070<br/>Telefax: +371 67320100<br/>+371 29270690<br/>Email: sar@mrcc.lv<br/>Russian Maritime Register of Shipping</p> |
| <b>LIBERIA</b>   | <p>American Bureau of Shipping<br/>Commissioner/Administration<br/>Bureau of Maritime Affairs<br/>P.O. Box 10-9042<br/>Monrovia 10<br/>1000<br/>LIBERIA<br/>Telephone: +231 227 744 / 37747 / 510 201<br/>Telefax: +231 226 069<br/>Email: maritime@liberia.net</p> <p>Bureau Veritas<br/>China Classification Society<br/>Det Norske Veritas<br/>Germanischer Lloyd<br/>Korean Register of Shipping<br/>Lloyd's Register of Shipping<br/>Nippon Kaiji Kyokai<br/>Polski Rejestr Statkow<br/>Registro Italiano Navale<br/>Russian Maritime Register of Shipping</p>  |
| <b>LITHUANIA</b> | <p>Lithuanian Maritime Safety Administration<br/>J. Janonio str.24<br/>Klaipeda<br/>92251<br/>LITHUANIA<br/>Telephone: +370 46 469 662<br/>Telefax: +370 46 469 600<br/>Email: alvydas.nikolajus@msa.lt</p>  |

| Country                         | Contact information for the main designated national competent authority  |
|---------------------------------|---|
| <b>LITHUANIA</b><br>(continued) | <p>Under The Ministry of Transport and Communications<br/>Lithuanian Transport Safety Administration<br/>Švitrigailos str. 42<br/>Vilnius<br/>LT-03209<br/>LITHUANIA<br/>Telephone: +370 5 278 5602<br/>Telefax: +370 5 213 2270<br/>Email: ltsa@ltsa.lrv.lt<br/>Website: https://www.ltsa.lrv.lt</p> <p>Water Transport Department<br/>Ministry of Transport and Communications<br/>Gedimino Av. 17<br/>Vilnius<br/>01505<br/>LITHUANIA<br/>Telephone: +370 5 239 3986<br/>Telefax: +370 5 212 4335<br/>Email: d.krivickiene@transp.lt</p> |
| <b>MADAGASCAR</b>               | <p>Internal Waters, Territorial Sea, Exclusive Economic Zone<br/>Mr. Adonis Fabien Tafangy<br/>Directeur des Affaires Internationales, Juridiques et Environnementales<br/>Agence Portuaire, Maritime et Fluviale (APMF)<br/>APMF Siège Alarobia<br/>Route des Hydrocarbures<br/>Antananarivo<br/>101<br/>MADAGASCAR<br/>Telephone: +261 321125759<br/>Telefax: +261 202453934<br/>Email: adonis@apmf.mg<br/>adonistafangy@yahoo.fr<br/>apmf@apmf.mg<br/>Website: http://www.apmf.mg</p>  |
| <b>MALAWI</b>                   | <p>Marine Department - Director of Marine Services<br/>Ministry of Transport &amp; Civil Aviation<br/>Private Bag A81<br/>Lilongwe<br/>MALAWI<br/>Telephone: +265 1 752 666<br/>+265 1 753 531<br/>+265 1 755 546<br/>Telefax: +265 1 750 157<br/>+265 1 758 894<br/>Email: marinedepartment@malawi.net<br/>marinesafety@africa-online.net</p>  |
| <b>MALAYSIA</b>                 | <p>Mr. Arumugam VS Subramaniam<br/>Director, Maritime Operation Division<br/>Marine Department of Malaysia<br/>P.O Box 12, Jalan Limbungan<br/>Malaysia Marine Department, HQ<br/>Port Kelang<br/>Selangor<br/>42007<br/>MALAYSIA<br/>Telephone: +603 3169 5222<br/>Telex: MA 39748<br/>Telefax: +603 3168 5020<br/>Email: bom@marine.gov.my<br/>Website: http://www.marine.gov.my/jlmv4/en<br/>Telex: MA 39748</p>   |

Part 7 – Provisions concerning transport operations

| Country                 | Contact information for the main designated national competent authority  |
|-------------------------|---|
| <b>MARSHALL ISLANDS</b> | <p>Mr. Simon Bonnett<br/>Technical Services<br/>RMI Maritime Administrator<br/>Second Floor, 80 Cannon Street<br/>London<br/>EC4N 6HL<br/>UNITED KINGDOM<br/>Telephone: +44 20 7638 4748<br/>Email: technical@register-iri.com</p>  |
| <b>MAURITANIA</b>       | <p>Mr. Mohamed Elmoctar Tolba<br/>Directeur de la Marine Marchande<br/>Ministère des Pêches et de l'Économie Maritime<br/>Nouakchott<br/>137<br/>MAURITANIA<br/>Telephone: +222 36361300<br/>Telefax: +222 45297104<br/>Email: tolbamoctar@yahoo.fr<br/>Website: https://www.peches.gov.mr</p>  |
| <b>MAURITIUS</b>        | <p>Director of Shipping<br/>Ministry of Land Transport Shipping and Public Safety<br/>New Govt. Centre 4 Floor<br/>Port Louis<br/>MAURITIUS<br/>Telephone: +230 201 2115<br/>+230 774 0764<br/>Telefax: +230 211 7699<br/>+230 216 1612<br/>+230 201 3417<br/>Email: pseebaluck@mail.gov.mu</p>   |
| <b>MEXICO</b>           | <p>Coordinador General: Ruiz de Teresa Guillermo Raúl<br/>Secretaría de Comunicación y Transportes<br/>Coordinación General de Puertos y Marina Mercante<br/>Boulevard Adolfo López Mateos No. 1990<br/>Col. Los Alpes Tlacopac<br/>Del. Álvaro Obregón<br/>Distrito Federal<br/>01010<br/>MEXICO<br/>Telephone: +52 (55) 5723 9300<br/>Email: coordgral.cgpm@sct.gob.mx</p> <p>María Isabel López Martínez<br/>Directora Ejecutiva<br/>Entidad Mexicana de Acreditación A.C.<br/>Mariano Escobedo, No.564,<br/>Col. Nueva Anzures, Delegación<br/>Miguel Hidalgo<br/>Ciudad de México<br/>C.P. 11590<br/>MEXICO<br/>Telephone: +52 (55) 91484300<br/>Email: Maribel.lopez@ema.org.mx</p> |



| Country                             | Contact information for the main designated national competent authority   |
|-------------------------------------|--|
| <b>MEXICO</b><br><i>(continued)</i> | Cap. Nav. CG. DEM.<br>Fernando Enrique Vega Maury<br>Director de Ordenamientos y Enlace de Asuntos Marítimos<br>Secretaría de Marina<br>Av. Heroica Escuela Naval Militar nº 669<br>Col. Presidentes Ejidales, 2da. Sección<br>Delegación Coyoacán<br>Ciudad de México<br>04470<br>MEXICO<br>Telephone: +52 (55) 5624 6500 Ext. 1797<br>Email: unicapam.doram@semar.gob.mx |
| <b>MONGOLIA</b>                     | Division of Ship Registration and Monitoring<br>Mongolia Maritime Administration<br>Government Building 11<br>Sambuu's street 11<br>Chingeltei district<br>Ulaanbaatar<br>211238<br>MONGOLIA<br>Telephone: +976 51 261490<br>Telefax: +976 11 310642<br>Email: info@monmarad.gov.mn,<br>operation@mngship.org<br>Website: http://monmarad.gov.mn/                          |
| <b>MONTENEGRO</b>                   | Department for Contingency<br>Plans and Civil Security<br>Ministry of Interior and Public Administration of the Republic of<br>MONTENEGRO<br>Telephone: +382 81 241 590<br>Telefax: +382 81 246 779<br>Email: mup.emergency@cg.yu  |
| <b>MOROCCO</b>                      | Ms. Hanane Atmane<br>Division de la Sécurité Maritime, SSNPPN<br>Direction de la Marine Marchande DSM-SSNPPN<br>01 Place Zellaqa<br>Casablanca<br>20000<br>MOROCCO<br>Telephone: +212 642946243<br>Email: hanan.atmane@yahoo.fr<br>Website: http://www.equipementtransport.gov.ma  |
| <b>MYANMAR</b>                      | Director, Nautical Division<br>Department of Marine Administration<br>Ministry of Transport and Communications<br>No. 363/421<br>Corner of Merchant and Theinbyu Road<br>Botataung Township<br>Yangon<br>MYANMAR<br>Telephone: +95 1 397640<br>Telefax: +95 1 397641<br>Email: motc@dma.gov.mm<br>nd@dma.gov.mm<br>Website: https://dma.gov.mm/                            |

Part 7 – Provisions concerning transport operations

| Country                         | Contact information for the main designated national competent authority  |
|---------------------------------|---|
| <b>NETHERLANDS</b>              | <p>Ministry of Infrastructure and the Environment<br/>P.O. Box 20901<br/>2500 EX The Hague<br/>The Netherlands<br/>Telephone: +31 456 0000<br/>Email: dangerousgoods@minienm.nl</p> <p><i>For competent authority approvals under the IMDG Code:</i><br/>Ministry of Infrastructure and the Environment<br/>Human Environment and Transport Inspectorate<br/>P.O. Box 90653<br/>2509 LR The Hague<br/>The Netherlands<br/>Telephone: +31 88 489 00 00<br/>Telefax: +31 70 456 2413<br/>Email: www.ivw.nl/english/contact</p>  |
| <b>NETHERLANDS<br/>ANTILLES</b> | <p>Directorate of Shipping &amp; Maritime Affairs<br/>Seru Mahuma z/n<br/>Curaçao<br/>Netherlands Antilles (Netherlands)<br/>Telephone: +599(9) 839 3700<br/>Telefax: +599(9) 868 9964<br/>Email: via sina@onenet.an<br/>expertise@dsmz.org<br/>management@dsmz.org</p>   |
| <b>NEW ZEALAND</b>              | <p>Maritime New Zealand<br/>Level 10 1<br/>Grey Street<br/>Wellington<br/>New Zealand</p> <p>PO Box 25620<br/>Wellington 6146<br/>New Zealand<br/>Telephone: +64 4 473 0111<br/>Telefax: +64 4 494 1263<br/>Email: enquiries@maritimenz.govt.nz<br/>Website: www.maritimenz.govt.nz</p> <p><i>The authorized organizations which have delegated authority from the Director of Maritime New Zealand for the approval, inspection and testing of all portable tanks, tank containers and freight containers are:</i><br/>American Bureau of Shipping<br/>Bureau Veritas<br/>Det Norske Veritas<br/>Germanischer Lloyd<br/>Lloyd's Register of Shipping</p> |
| <b>NIGERIA</b>                  | <p>Nigerian Maritime Administration and Safety Agency (NIMASA)<br/>Marine House<br/>4 Burma Road<br/>Apapa<br/>P.M.B. 12861, GPO, Marina Lagos<br/>Nigeria<br/>Telephone: +234 587 2214 / 580 4800/9<br/>Telefax: +234 587 1329<br/>Telex: 23891, NAMARING<br/>Website: www.nimasa.gov.ng</p>   |

| Country         | Contact information for the main designated national competent authority  |
|-----------------|---|
| <b>NORWAY</b>   | <p>Norwegian Maritime Authority<br/>Smedasundet 50A<br/>N-5528 Haugesund<br/>NORWAY<br/>Telephone: +47 5274 5000<br/>Teleax: +47 5274 5001<br/>Email: postmottak@sjofartsdir.no<br/>Website: http://www.sdir.no</p> <p><i>Certification of packaging and IBCs, Certification of CSC containers and Certification of IMO Tanks</i><br/>DNV GL A/S<br/>Veritasveien 1<br/>N-1322 Høvik<br/>NORWAY<br/>Telephone: +47 67 57 9900<br/>Email: moano374@dnvgl.com</p> <p>NET Emballasje-org Produkttesting AS<br/>Blekebakkvegen 45<br/>N-3950 Brevik<br/>NORWAY<br/>Telephone: +47 951 98 187<br/>Email: info@net17025.com</p> <p>Lloyd's Register EMEA<br/>P.O. Box 1562 Vika<br/>N-0253 Oslo<br/>NORWAY<br/>Telephone: +47 23 23 92 70<br/>Telefax: +47 23 23 92 71<br/>Email: oslo@lr.org</p> |
| <b>PAKISTAN</b> | <p>Mr. Syed Salman Raza<br/>Principal Officer<br/>Mercantile Marine Department<br/>70/4 Timber Pond<br/>Keamari<br/>Karachi<br/>Sindh<br/>PAKISTAN<br/>Telephone: +92 2199263014<br/>Email: info@mercantilemarine.gov.pk</p>  |
| <b>PALAU</b>    | <p>Mr. Achilleas Papatthasiou<br/>Maritime Safety &amp; Compliance Division, Technical Officer<br/>Palau International Ship Registry - Ship Registry Administrator<br/>5, Sachtouri Street, 6th floor<br/>Piraeus<br/>18536<br/>GREECE<br/>Telephone: +1 832 631 6061<br/>+30 210 4293 500<br/>Telefax: +30 210 4293 505<br/>+1 832 631 6061<br/>Email: info@palaureg.com<br/>Website: https://www.palaureg.com</p>   |

Part 7 – Provisions concerning transport operations

| Country                 | Contact information for the main designated national competent authority   |
|-------------------------|--|
| <b>PANAMA</b>           | <p>Capt. José Vallester<br/>General Directorate of Ports and Ancillary Maritime Services<br/>Panama Maritime Authority<br/>Diablo Heights, Building 5534<br/>Balboa, Ancón<br/>0843-0533<br/>PANAMA<br/>Telephone: +507 501-4244<br/>Email: jvallester@amp.gob.pa<br/>Website: <a href="http://www.amp.gob.pa">http://www.amp.gob.pa</a></p>   |
| <b>PAPUA NEW GUINEA</b> | <p>Capt. Krzysztof Orłowski<br/>Executive Manager Maritime Operations<br/>National Maritime Safety Authority<br/>Level 3, Defens Haus<br/>P.O. Box 668<br/>(675)3054 602<br/>Port Moresby<br/>0121<br/>PAPUA NEW GUINEA<br/>Telephone: +675 305 4602<br/>+675 720 454 02<br/>Telefax: +675 321 0873<br/>Email: korlowski@nmsa.gov.pg<br/>enquiries@nmsa.gov.pg<br/>Website: <a href="http://www.nmsa.gov.pg">http://www.nmsa.gov.pg</a></p> <p>Capt. Graham R Proud<br/>Executive Manager Maritime Administration<br/>National Maritime Safety Authority<br/>Level 3, Defens Haus<br/>P.O. Box 668, Port Moresby<br/>National Capital District<br/>Port Moresby<br/>PAPUA NEW GUINEA<br/>Telephone: +675 70053054<br/>+675 3054600<br/>Telefax: +675 3213051<br/>Email: gproud@nmsa.gov.pg,<br/>enquiries@nmsa.gov.pg<br/>Website: <a href="http://www.nmsa.gov.pg">http://www.nmsa.gov.pg</a></p> |
| <b>PERU</b>             | <p>C. de C. Víctor Lun Pun Torres<br/>Jefe del Dpto. de Protección del Ambiente Acuático de la Dirección del Ambiente Acuático<br/>Dirección General de Capitanías y Guardacostas (DICAPI)<br/>Jirón Constitución N° 150<br/>Callao<br/>07001<br/>PERU<br/>Telephone: +51 12099300<br/>+51 975483782<br/>Email: dicapidirmam@dicapi.mil.pe,<br/>lunpu001@dicapi.mil.pe</p>   |
| <b>PORTUGAL</b>         | <p>Direção-Geral de Recursos Naturais, Segurança e Serviços Marítimos (DGRM)<br/>Av. Brasília<br/>1449-030 Lisboa<br/>PORTUGAL<br/>Telephone: +351 213 035 700<br/>Telefax: +351 213 035 702<br/>Email: <a href="mailto:dgrm@dgrm.mm.gov.pt">dgrm@dgrm.mm.gov.pt</a></p>   |

| Country                  | Contact information for the main designated national competent authority   |
|--------------------------|--|
| <b>QATAR</b>             | <p>Eng. Abdulla Al Qahtani<br/>Act. Director of Marine Regulations Department<br/>Ministry of Transport<br/>Doha, Qatar<br/>23024<br/>QATAR</p> <p>Telephone: +974 40451937<br/>+974 40451549<br/>+974 40451513</p> <p>Telefax: +974 4371109</p> <p>Email: mrd@mot.gov.qa<br/>abdallah.alqahtani@mot.gov.qa</p>  |
| <b>REPUBLIC OF KOREA</b> | <p>Mr. Jeong Woong Hwang<br/>Maritime Industry and Technology Division<br/>Ministry of Oceans &amp; Fisheries<br/>Government complex Sejong, 5-Dong,<br/>94, Dasom 2-Ro<br/>Maritime Affairs and Safety Policy Bureau in MOF (Ministry of Oceans &amp; Fisheries)<br/>Sejong-City<br/>3110<br/>REPUBLIC OF KOREA</p> <p>Telephone: +82 44 200 5836<br/>+82 44 200 5837</p> <p>Telefax: +82 44 200 5839</p> <p>Email: hwangjw@korea.kr<br/>sail2@korea.kr</p> <p>Website: <a href="http://www.mof.org">http://www.mof.org</a></p> |
| <b>ROMANIA</b>           | <p>Territorial waters<br/>Constanta Harbour Master<br/>Romanian Naval Authority<br/>Inside harbour, gate no.1, ANR building<br/>Constanta<br/>900900<br/>ROMANIA</p> <p>Telephone: +40 372419833<br/>+40 372416803</p> <p>Telefax: +40 241618299<br/>+40 372416808</p> <p>Email: cz-constant@rna.ro<br/>rna@rna.ro</p> <p>Website: <a href="https://portal.rna.ro">https://portal.rna.ro</a></p>   |

Part 7 – Provisions concerning transport operations

| Country            | Contact information for the main designated national competent authority  |
|--------------------|---|
| RUSSIAN FEDERATION | <p>Department of State Policy for Maritime and River Transport<br/>Ministry of Transport of the Russian Federation<br/>Rozhdestvenka Street, 1, bldg. 1<br/>Moscow 109012<br/>RUSSIAN FEDERATION<br/>Telephone: +7 499 495 05 50<br/>Fax: +7 499 495 00 00 (ext. 0559)<br/>Email: rusma@mintrans.ru</p> <p><i>Organizations authorized for approval, acceptance and all consequential activities related to IMO Type tanks, CSC containers, Intermediate Bulk Containers (IBCs) and packaging:</i><br/>Russian Maritime Register of Shipping<br/>8, Dvortsovaya Naberezhnaya<br/>Saint-Petersburg 191186<br/>RUSSIAN FEDERATION<br/>Telephone: +7 812 380 20 72<br/>Fax: +7 812 314 10 87<br/>Email: pobox@rs-class.org<br/>Website: <a href="http://www.rs-head.spb.ru">http://www.rs-head.spb.ru</a></p> <p>Central Marine Research and Design Institute (CNIIMF)<br/>6, Kavalergardskaya Street,<br/>Saint Petersburg, 191015<br/>RUSSIAN FEDERATION<br/>Telephone: +7 812 275 89 45<br/>Email: <a href="mailto:cniimf@cniimf.ru">cniimf@cniimf.ru</a></p> |
| SAMOA              | <p>Exclusive Economic Zone, Territorial Seas, Internal waters<br/>Mr. Magele Hoe Viali<br/>Maritime Policy and Administration Division<br/>Ministry of Works, Transport and Infrastructure<br/>Private Bag<br/>Level 4, TATTE Building<br/>Sogi<br/>Apia<br/>SAMOA<br/>Telephone: +685 21611<br/>Email: <a href="mailto:hoe.viali@mwti.gov.ws">hoe.viali@mwti.gov.ws</a><br/>Website: <a href="http://www.mwti.gov.ws">http://www.mwti.gov.ws</a></p>   |
| SAUDI ARABIA       | <p>Mr. Salah Ghazzawi<br/>Director Of Central Department for Industrial Safety<br/>Saudi Ports Authority (MAWANI)<br/>Prince Abdulrahman Bin Abdulaziz St.<br/>P.O.Box 75606<br/>Riyadh<br/>11588<br/>SAUDI ARABIA<br/>Telephone: +966 561841418<br/>+966 114089660<br/>Telefax: +966 114121361<br/>Email: <a href="mailto:s.ghazzawi@mawani.gov.sa">s.ghazzawi@mawani.gov.sa</a><br/>Website: <a href="https://mawani.gov.sa">https://mawani.gov.sa</a></p>  |

| Country                | Contact information for the main designated national competent authority  |
|------------------------|---|
| <b>SERBIA</b>          | <p>Mr. Predrag Jevremovic<br/>Group for Maritime Navigation<br/>Ministry of Construction, Transport and Infrastructure<br/>Nemanjina Street No. 22 – 24<br/>11000 Belgrade<br/>SERBIA</p> <p>Telephone: +381 11 202 99 10<br/>+381 11 361 65 20</p> <p>Telefax: +381 11 202 99 01<br/>+381 11 364 03 37</p> <p>Email: predrag.jevremovic@mgsi.gov.rs<br/>veljko.kovacevic@mgsi.gov.rs</p>   |
| <b>SINGAPORE</b>       | <p>Mr. New Chee Wee<br/>Senior Port Chemist<br/>Maritime and Port Authority of Singapore<br/>7B Keppel Road, #19-00 Tanjong<br/>Pagar Complex<br/>089055<br/>SINGAPORE</p> <p>Telephone: +65 6325 2428</p> <p>Telefax: +65 6325 2430</p> <p>Email: imo_gisis@mpa.gov.sg</p>   |
| <b>SOLOMON ISLANDS</b> | <p>Mr. Jonah Mitau<br/>Director<br/>Ministry of Infrastructure and Development<br/>Solomon Islands Maritime Safety Administration Division<br/>P.O Box G32<br/>Honiara<br/>SOLOMON ISLANDS</p> <p>Telephone: +677 21535 ext. 205</p> <p>Telefax: +677 23798</p> <p>Email: JMitau@mid.gov.sb</p> <p>Mr. Thierry Nervale<br/>Director<br/>Solomon Islands Maritime Authority<br/>P O Box, 1932<br/>Honiara<br/>SOLOMON ISLANDS</p> <p>Telephone: +677 756 94 73</p> <p>Email: thierry.nervale@sima.gov.sb</p> <p>Mr Jonah Mitau<br/>Deputy Director Compliance &amp; Standards<br/>Solomon Islands Maritime Safety Administration<br/>SIMSA<br/>P. O. Box G32<br/>Honiara<br/>SOLOMON ISLANDS</p> <p>Telephone: +677 21535 Ext 205</p> <p>Telefax: +677 23798</p> <p>Email: JMitau@mid.gov.sb</p> <p>Mr. Jonah Mitau<br/>Director<br/>Ministry of Infrastructure and Development<br/>Solomon Islands Maritime Safety Administration Division<br/>P.O Box G32<br/>Honiara<br/>SOLOMON ISLANDS</p> <p>Telephone: +677 21535 ext. 205</p> <p>Telefax: +677 23798</p> <p>Email: JMitau@mid.gov.sb</p> |



Part 7 – Provisions concerning transport operations

| Country                               | Contact information for the main designated national competent authority  |
|---------------------------------------|---|
| <b>SOLOMON ISLANDS</b><br>(continued) | Capt. Thierry Nervale<br>Maritime Casualty and Investigation Officer<br>Solomon Islands Maritime Authority<br>P O Box, 1932,<br>Honiara,<br>SOLOMON ISLANDS<br>Telephone: +677 21535 ext. 207, +677 21535<br>Telefax: +677 23798, 677 23798<br>Email: thierry.nervale@sima.gov.sb   |
| <b>SOUTH AFRICA</b>                   | Capt. Winston Lobo<br>Senior Technical Manager<br>South African Territorial Waters<br>South African Maritime Safety Authority<br>Private Bag X54309<br>Durban<br>KwaZulu-Natal<br>4000<br>SOUTH AFRICA<br>Telephone: +27 31 307 3006<br>+27 71 686 9652<br>Telefax: +27 31 307 3086<br>Email: wlobo@samsa.org.za  |
| <b>SPAIN</b>                          | Subdirección General de Seguridad<br>Contaminación e Inspección Marítima<br>Directorate General of the Merchant Marine<br>C/ Ruiz de Alarcón 1<br>Madrid<br>SPAIN<br>Telephone: +34 91 597 9269<br>Telefax: +34 91 597 9235<br>Email: mmpp.dgmm@mitma.es<br><br>Subdirección General de Calidad y Seguridad Industrial<br>Ministerio de Industria, Comercio y Turismo<br>C/ Paseo de la Castellana, 160<br>28071<br>Madrid<br>SPAIN<br>Telephone: +34 91 349 5108<br>Telefax: +34 91 349 4300<br>Email: csegind@mincotur.es |
| <b>SURINAME</b>                       | Mr. Michel Amafo<br>Director<br>Maritime Authority Suriname<br>Cornelis jongbawstraat no. 2,<br>Paramaribo<br>888<br>SURINAME<br>Telephone: +597 476733<br>+597 476769<br>Telefax: +597 472940<br>Email: mamafo@mas.sr, info@mas.sr   |

| Country            | Contact information for the main designated national competent authority   |
|--------------------|--|
| <b>SWEDEN</b>      | <p>Helena Ejlerung<br/>Dangerous Goods Adviser<br/>Swedish Transport Agency<br/>Olai Kyrkogata 35<br/>Norrköping<br/>S-601 73<br/>SWEDEN<br/>Telephone: +46 10 495 33 22<br/>+46 767 21 15 84<br/>Email: helena.ejlerung@transportstyrelsen.se</p>   |
| <b>SWITZERLAND</b> | <p>Swiss Maritime Navigation Office (SMNO)<br/>Elisabethenstrasse 33<br/>P.O. Box<br/>Basel<br/>CH-4010<br/>SWITZERLAND<br/>Telephone: +41 58 467 11 20<br/>+41 79 157 75 93<br/>Telefax: +41 58 467 11 29<br/>Email: dv-ssa@eda.admin.ch<br/>roger-patrik.witschi@eda.admin.ch</p> <p>Capt. Roger Patrik Witschi<br/>Head<br/>Swiss Maritime Navigation Office (SMNO)<br/>Elisabethenstrasse 33<br/>P.O. Box<br/>Basel<br/>CH-4010<br/>SWITZERLAND<br/>Telephone: +41 58 461 13 25<br/>Telefax: +41 58 467 11 29<br/>Email: roger-patrik.witschi@eda.admin.ch</p> |
| <b>THAILAND</b>    | <p>Mr. Jarin Bootwong<br/>Harbour Master, Professional Level<br/>Marine Safety and Environment Bureau, Marine Department<br/>1278 Yotha Rd, Talat Noi,<br/>Samphanthawong<br/>Bangkok<br/>10100<br/>THAILAND<br/>Telephone: +662 233 1311-8<br/>Telefax: +662 238 2309<br/>Email: jarinbootwong01@gmail.com</p>  |
| <b>TOGO</b>        | <p>Mr. Matchonnawè Bakai<br/>Direction Des Affaires Maritimes<br/>Ministère de l'Économie Maritime, de la Pêche et de la Protection Côtière<br/>01 B.P:4771<br/>Lomé<br/>TOGO<br/>Telephone: +228 70435224<br/>+228 90097494<br/>+228 92851764<br/>Email: dam@maritime.gouv.tg<br/>matchonnawe.bakai@maritime.gouv.tg</p>  |

Part 7 – Provisions concerning transport operations

| Country | Contact information for the main designated national competent authority   |
|---------|--|
| TÜRKİYE | <p>Ms. N. Kubra Sarikaya<br/>Directorate General for Maritime Affairs<br/>Ministry of Transport and Infrastructure<br/>Hakki Turaylıç Cd. No:5 C Blok<br/>Denizcilik Genel Müdürlüğü<br/>Emek/Çankaya<br/>Ankara<br/>06570<br/>TÜRKİYE<br/>Telephone: +90 312 203 10 00/39 14<br/>Telefax: +90 312 231 51 89<br/>Email: dangerousgoods@uab.gov.tr<br/>nkubra.sarikaya@uab.gov.tr</p> <p>Turkish Standards Institution (TSE)<br/>100. Yıl Bulvarı No:99 Kat:2<br/>Ostim/Ankara<br/>TÜRKİYE<br/>Telephone: +90 312 592 50 00 ext.5039<br/>Telefax: +90 312 592 50 05<br/>Email: oalper@tse.org.tr</p>  |
| UKRAINE | <p>Mr. Fisher Andriy<br/>Director<br/>LLC “ECOSEASERVICE”<br/>Chornomorskogo kozatstva str. 23<br/>Office 205<br/>Odesa<br/>65003<br/>UKRAINE<br/>Telephone: +380 989759517<br/>Email: ecoseaservice@ukr.net</p> <p>Mrs. Afanasyeva Yevgenia<br/>General Director<br/>RPE “MORSERVICE” LTD.<br/>Preobrazhenska Str. 30<br/>Office 2<br/>Odesa<br/>65082<br/>UKRAINE<br/>Telephone: +380 487 84 14 93<br/>Email: morservice@te.net.ua</p> <p>Mr. Sergii Savinkov<br/>State Enterprise “Scientific Research and Design Institute<br/>of the Maritime Transport of Ukraine”<br/>Lanzheronivska Str. 15A<br/>Odesa<br/>65026<br/>UKRAINE<br/>Telephone: +380 487 34 87 28<br/>Email: unii@ukr.net</p> <p>Mr. Sergii Aleksandrov<br/>Directorate-General for Transport Safety<br/>Ministry of Infrastructure of Ukraine<br/>Head of expert group for safety of transportation of dangerous goods<br/>Peremohy Ave. 14<br/>Kiev<br/>01135<br/>UKRAINE<br/>Telephone: +380 443 51 41 53<br/>Email: aleksandrov@mtu.gov.ua</p> |

| Country                               | Contact information for the main designated national competent authority   |
|---------------------------------------|--|
| <b>UNITED ARAB EMIRATES</b>           | Capt. Abdulla Alhayyas<br>Department of Maritime Transport Affairs<br>Federal Transport Authority<br>Abu Dhabi<br>UAE<br>PO Box:900<br>UNITED ARAB EMIRATES<br>Telephone: +971 24182240<br>+971 24182165<br>Telefax: +971 26506027<br>Email: SHIPPING@fta.gov.ae<br>abdulla.alhayyas@fta.gov.ae  |
| <b>UNITED KINGDOM</b>                 | Cargoes, Safety and Pollution Prevention Team<br>Maritime and Coastguard Agency<br>Spring Place<br>105 Commercial Road<br>Southampton<br>Hampshire<br>SO15 1EG<br>UNITED KINGDOM<br>Telephone: +44 0203 81 72469<br>Email: Dangerous.Goods@mcga.gov.uk   |
| <b>UNITED KINGDOM<br/>Isle of Man</b> | Mr. Brian Thomson<br>Isle of Man Ship Registry<br>Department for Enterprise<br>St George's Court<br>Upper Church Street<br>Douglas<br>Isle of Man<br>IM1 1EX<br>ISLE OF MAN (UNITED KINGDOM)<br>Telephone: +44 (0)1624 688500<br>Email: Marine.survey@gov.im<br>Website: <a href="http://www.iomshipregistry.com">http://www.iomshipregistry.com</a>   |
| <b>UNITED STATES</b>                  | U.S. Department of Transportation<br>Pipeline and Hazardous Materials Safety Administration<br>Office of International Standards<br>East Building /PHH-70<br>1200 New Jersey Ave S.E.<br>Washington, D.C. 20590<br>UNITED STATES OF AMERICA<br>Telephone: +1 202 366 0656<br>Email: infocntr@dot.gov<br><br>Commandant (CG-ENG-5)<br>U.S. Coast Guard, Stop 7509<br>Attn: Chief, Hazardous Materials Division<br>2703 Martin Luther King Jr. Ave. SE<br>Washington, D.C. 20593-7509<br>UNITED STATES OF AMERICA<br>Telephone: +1 202 372 1420<br>Email: hazmatstandards@uscg.mil |

Part 7 – Provisions concerning transport operations

| Country                 | Contact information for the main designated national competent authority  |
|-------------------------|---|
| <b>ASSOCIATE MEMBER</b> |   |
| <b>HONG KONG, CHINA</b> | Senior Marine Officer / Dangerous Goods Unit<br>Marine Department<br>3/F., Harbour Building,<br>38 Pier Road, Central,<br>Hong Kong, China<br>Telephone: +852 2852 4913<br>Telefax: +852 2815 8596<br>Email: pfdg@mardep.gov.hk |

# Appendix 2

(part 3, appendices  
and Index)

# Contents

|               |   |     |
|---------------|---|-----|
| <b>PART 1</b> | <b>GENERAL PROVISIONS, DEFINITIONS AND TRAINING</b>   |     |
|               | <i>See Appendix 1</i>   |     |
| <b>PART 2</b> | <b>CLASSIFICATION</b>   |     |
|               | <i>See Appendix 1</i>   |     |
| <b>PART 3</b> | <b>DANGEROUS GOODS LIST, SPECIAL PROVISIONS AND EXCEPTIONS</b>                                      |     |
|               | <b>Chapter 3.1 General</b>  |     |
|               | 3.1.1 Scope and general provisions .....  | 3   |
|               | 3.1.2 Proper shipping names .....   | 4   |
|               | 3.1.3 Mixtures or solutions .....   | 5   |
|               | 3.1.4 Segregation groups .....  | 6   |
|               | <b>Chapter 3.2 Dangerous Goods List</b>   |     |
|               | 3.2.1 Structure of the Dangerous Goods List .....   | 21  |
|               | 3.2.2 Abbreviations and symbols .....   | 23  |
|               | Dangerous Goods List .....  | 25  |
|               | <b>Chapter 3.3 Special provisions applicable to certain substances, materials or articles</b> ..... | 199 |
|               | <b>Chapter 3.4 Dangerous goods packed in limited quantities</b>                                     |     |
|               | 3.4.1 General .....   | 231 |
|               | 3.4.2 Packing .....   | 231 |
|               | 3.4.3 Stowage .....   | 231 |
|               | 3.4.4 Segregation .....   | 231 |
|               | 3.4.5 Marking and placarding .....  | 232 |
|               | 3.4.6 Documentation .....   | 233 |
|               | <b>Chapter 3.5 Dangerous goods packed in excepted quantities</b>                                    |     |
|               | 3.5.1 Excepted quantities .....   | 234 |
|               | 3.5.2 Packagings .....  | 235 |
|               | 3.5.3 Tests for packages .....  | 235 |
|               | 3.5.4 Marking of packages .....   | 235 |
|               | 3.5.5 Maximum number of packages in any cargo transport unit .....                                  | 236 |
|               | 3.5.6 Documentation .....   | 236 |
|               | 3.5.7 Stowage .....   | 236 |
|               | 3.5.8 Segregation .....   | 236 |



---

**PART 4 PACKING AND TANK PROVISIONS**

*See Appendix 1*

**PART 5 CONSIGNMENT PROCEDURES**

*See Appendix 1*

**PART 6 CONSTRUCTION AND TESTING OF PACKAGINGS, INTERMEDIATE BULK  
CONTAINERS (IBCs), LARGE PACKAGINGS, PORTABLE TANKS,  
MULTIPLE-ELEMENT GAS CONTAINERS (MEGCs)  
AND ROAD TANK VEHICLES**

*See Appendix 1*

**PART 7 PROVISIONS CONCERNING TRANSPORT OPERATIONS**

*See Appendix 1*

**APPENDICES**

|            |  |     |
|------------|--|-----|
| Appendix A | List of generic and N.O.S. proper shipping names ..... | 239 |
| Appendix B | Glossary of terms .....                                | 255 |

|             |     |
|-------------|-----|
| INDEX ..... | 265 |
|-------------|-----|

# **PART 3**

**DANGEROUS GOODS LIST,  
SPECIAL PROVISIONS AND EXCEPTIONS**



## Chapter 3.1

---

### General

#### 3.1.1 Scope and general provisions

- 3.1.1.1 The Dangerous Goods List in chapter 3.2 lists many of the dangerous goods most commonly transported. The list includes entries for specific chemical substances and articles and generic or “not otherwise specified” entries. Since it is not practical to include a separate entry for every chemical substance or article of commercial importance specifically by name, especially names for mixtures and solutions of various chemical constituents and concentrations, the Dangerous Goods List also includes generic or “not otherwise specified” names (e.g. EXTRACTS, LIQUID, for flavour or aroma, UN 1197 or FLAMMABLE LIQUID, N.O.S., UN 1993). On this basis, the Dangerous Goods List is intended to include an appropriate name or entry for any dangerous good which may be transported.
- 3.1.1.2 Where a dangerous good is specifically listed by name in the Dangerous Goods List, it shall be transported in accordance with the provisions in the List which are appropriate for that dangerous good. A generic or “not otherwise specified” entry may be used to permit the transport of substances, materials or articles which do not appear specifically by name in the Dangerous Goods List. Such a dangerous good may be transported only after its dangerous properties have been determined. Dangerous goods shall be classified according to the class definitions, tests and criteria. The name which most appropriately describes the dangerous goods shall be used. Only when the specific name of the dangerous goods does not appear in the Dangerous Goods List or the associated primary or subsidiary hazards assigned to it are not appropriate may a generic or “not otherwise specified” name be used. The classification shall be made by the shipper/consignor or by the appropriate competent authority where so specified in the Code. Once the class of the dangerous good has been so established, all conditions for transport, as provided in this Code, shall be met. Any dangerous good having or suspected of having explosive characteristics shall first be considered for inclusion in class 1. Some collective entries may be of the generic or “not otherwise specified” type provided that the Code contains provisions ensuring safety, both by excluding extremely dangerous goods from normal transport and by covering all subsidiary hazards inherent in some goods.
- 3.1.1.3 Inherent instability in goods may take different dangerous forms, for example explosion, polymerization with intense evolution of heat or emission of flammable, toxic, corrosive or asphyxiant gases. The Dangerous Goods List indicates that certain dangerous goods, or dangerous goods in a specific form, concentration or state, are prohibited for transport by sea. This means that the goods specified are not suitable for transport by sea under normal conditions of transport. This does not mean that such goods may not be transported under any circumstances. For most goods, such inherent instability can be controlled by suitable packaging, dilution, stabilization, addition of an inhibitor, temperature control or other measures.
- 3.1.1.4 Where precautionary measures are laid down in the Dangerous Goods List in respect of a given dangerous good (such as that it shall be “stabilized” or “with x% water or phlegmatizer”), such dangerous good may not normally be transported when these measures have not been taken, unless the item in question is listed elsewhere (such as class 1) without any indication of, or with different, precautionary measures.
- 3.1.1.5 Certain substances, by the nature of their chemical composition, tend to polymerize or otherwise react in a dangerous manner under certain conditions of temperature or in contact with a catalyst. Mitigation of this tendency can be carried out either by requiring special transport conditions or by adding adequate amounts of chemical inhibitors or stabilizers to the product. These products shall be sufficiently stabilized to prevent any dangerous reaction during the intended voyage. If this cannot be ensured, the transport of such products is prohibited.
- 3.1.1.6 Where the contents of a portable tank is to be transported heated, the transport temperature is to be maintained during the intended voyage unless it is established that crystallization or solidification on cooling would not result in instability, which can occur with some stabilized or inhibited products.

## Part 3 – Dangerous Goods List, special provisions and exceptions

3

## 3.1.2 Proper shipping names

**Note 1:** The proper shipping names of the dangerous goods are those listed in chapter 3.2, Dangerous Goods List. Synonyms, secondary names, initials, abbreviations of names, etc. have been included in the Index to facilitate the search for the proper shipping name (see part 5, Consignment procedures).

**Note 2:** For proper shipping names to be used for transport of samples, see 2.0.4. For proper shipping names to be used for transport of wastes, see 5.4.1.4.3.3.

3.1.2.1 The proper shipping name is that portion of the entry most accurately describing the goods in the Dangerous Goods List, which is shown in upper-case characters (plus any numbers, Greek letters, 'sec', 'tert', and the letters *m*, *n*, *o*, *p*, which form an integral part of the name). An alternative proper shipping name may be shown in brackets following the main proper shipping name (such as ETHANOL (ETHYL ALCOHOL)). Portions of an entry appearing in lower case need not be considered as part of the proper shipping name but may be used.

△ 3.1.2.2 When a combination of several distinct proper shipping names are listed under a single UN number, and these are separated by "or" in lower case or are punctuated by commas, only the most appropriate shall be shown in the transport document and package marks.

Examples illustrating the selection of the proper shipping name for such entries are:

.1 UN 1057 LIGHTERS or LIGHTER REFILLS – The proper shipping name is the most appropriate of the following possible combinations:

LIGHTERS  
LIGHTER REFILLS;

.2 UN 2583 ALKYL SULPHONIC ACIDS, SOLID or ARYL SULPHONIC ACIDS, SOLID with more than 5% free sulphuric acid – The proper shipping name is the most appropriate of the following:

ALKYL SULPHONIC ACIDS, SOLID  
ARYL SULPHONIC ACIDS, SOLID;

.3 UN 2793 FERROUS METAL BORINGS, SHAVINGS, TURNINGS or CUTTINGS in a form liable to self-heating. The proper shipping name is the most appropriate of the following combinations:

FERROUS METAL BORINGS  
FERROUS METAL SHAVINGS  
FERROUS METAL TURNINGS  
FERROUS METAL CUTTINGS.

3.1.2.3 Proper shipping names may be used in the singular or plural as appropriate. In addition, when qualifying words are used as part of the proper shipping name, their sequence on documentation or packages is optional. Commercial or military names for goods of class 1, which contain the proper shipping name supplemented by additional text, may be used.

3.1.2.4 Many substances have an entry for both the liquid and solid state (see definitions for *liquids* and *solids* in 1.2.1), or for the solid and solution. These are allocated separate UN numbers which are not necessarily adjacent to each other. Details are provided in the alphabetical index, e.g.:

NITROXYLENES, LIQUID – 6.1 1665  
NITROXYLENES, SOLID – 6.1 3447.

3.1.2.5 Where it is not already included, the qualifying word "MOLTEN" shall be added to the proper shipping name when a substance which is solid in accordance with the definition in 1.2.1 is offered for transport in the molten state (such as ALKYLPHENOL, SOLID, N.O.S., MOLTEN). For elevated temperature substances, see 5.4.1.4.3.4.

3.1.2.6 Except for self-reactive substances and organic peroxides and unless it is already included in capital letters in the name indicated in the Dangerous Goods List, the word STABILIZED shall be added as part of the proper shipping name of the substance which without stabilization would be forbidden from transport in accordance with 1.1.3 due to it being liable to dangerously react under conditions normally encountered in transport (such as TOXIC LIQUID, ORGANIC, N.O.S., STABILIZED). When temperature control is used to stabilize such substances to prevent the development of any dangerous excess pressure, or the evolution of excessive heat, or when chemical stabilization is used in combination with temperature control, then:

.1 For liquids and solids where the SAPT (measured without or with inhibitor, when chemical stabilization is applied) is less than or equal to that prescribed in 2.4.2.5.2, special provision 386 of chapter 3.3 and the provisions of 7.3.7 apply;

.2 Unless it is already included in capital letters in the name indicated in the Dangerous Goods List, the words "TEMPERATURE CONTROLLED" shall be added as part of the proper shipping name;

.3 For gases: the conditions of transport shall be approved by the competent authority.

3.1.2.7 Hydrates may be transported under the proper shipping name for the anhydrous substance.

### 3.1.2.8 Generic or “not otherwise specified” (N.O.S.) entries

3.1.2.8.1 Generic and “not otherwise specified” proper shipping names that are assigned to special provision 274 or 318 in column 6 of the Dangerous Goods List shall be supplemented with the technical or chemical group names unless a national law or international convention prohibits its disclosure if it is a controlled substance. For explosives of class 1, the dangerous goods description may be supplemented by additional descriptive text to indicate commercial or military names. Technical and chemical group names shall be entered in brackets immediately following the proper shipping name. An appropriate modifier, such as “contains” or “containing” or other qualifying words such as “mixture”, “solution”, etc., and the percentage of the technical constituent may also be used. For example: “UN 1993 Flammable liquid, n.o.s. (contains xylene and benzene), 3, PG II”.

3.1.2.8.1.1 The technical name shall be a recognized chemical or biological name or other name currently used in scientific and technical handbooks, journals and texts. Trade names shall not be used for this purpose. In the case of pesticides, only ISO common name(s), other name(s) in *The WHO Recommended Classification of Pesticides by Hazard and Guidelines to Classification*, or the name(s) of the active substance(s) may be used.

3.1.2.8.1.2 When a mixture of dangerous goods or articles containing dangerous goods are described by one of the “N.O.S.” or “generic” entries to which special provision 274 has been allocated in the Dangerous Goods List, not more than the two constituents which most predominantly contribute to the hazard or hazards of the mixture or of the articles need to be shown, excluding controlled substances when their disclosure is prohibited by national law or international convention. If a package containing a mixture is labelled with any subsidiary hazard label, one of the two technical names shown in brackets shall be the name of the constituent which compels the use of the subsidiary hazard label.

3.1.2.8.1.3 Examples illustrating the selection of the proper shipping name supplemented with the technical name of goods for such N.O.S. entries are:

UN 2902 PESTICIDE, LIQUID, TOXIC, N.O.S. (drazoxolon)

UN 3394 ORGANOMETALLIC SUBSTANCE, LIQUID, PYROPHORIC, WATER-REACTIVE  
(trimethylgallium).

UN 3540 ARTICLES CONTAINING FLAMMABLE LIQUID, N.O.S. (pyrrolidine)

### 3.1.2.9 Marine pollutants

3.1.2.9.1 For the purpose of documentation, the proper shipping name of “not otherwise specified” (N.O.S.) entries which are classified as marine pollutants in accordance with 2.10.3, shall be supplemented with the recognized chemical name of the constituent which most predominantly contributes to the classification as marine pollutant unless otherwise provided by SP274.

3.1.2.9.2 An example illustrating the selection of the proper shipping name supplemented with the recognized technical name of goods for such entries are is indicated below:

UN 1993 FLAMMABLE LIQUID, N.O.S. (propyl acetate, di-*n*-butyltin di-2-ethylhexanoate) class 3 PG III  
(50°C c.c.) MARINE POLLUTANT

### 3.1.3 Mixtures or solutions

**Note:** Where a substance is specifically listed by name in the Dangerous Goods List, it shall be identified in transport by the proper shipping name in the Dangerous Goods List. Such substances may contain technical impurities (for example those deriving from the production process) or additives for stability or other purposes that do not affect their classification. However, a substance listed by name containing technical impurities or additives for stability or other purposes affecting its classification shall be considered a mixture or solution (see 2.0.2.2 and 2.0.2.5).

3.1.3.1 A mixture or solution is not subject to the provisions of this Code if the characteristics, properties, form or physical state of the mixture or solution are such that it does not meet the criteria, including human experience criteria, for inclusion in any class.

3.1.3.2 A mixture or solution meeting the classification criteria of this Code composed of a single predominant substance identified by name in the Dangerous Goods List and one or more substances not subject to the provisions of this Code and/or traces of one or more substances identified by name in the Dangerous Goods List, shall be assigned the UN number and proper shipping name of the predominant substance named in the Dangerous Goods List unless:

- .1 the mixture or solution is identified by name in the Dangerous Goods List;
- .2 the name and description of the substance named in the Dangerous Goods List specifically indicate that they apply only to the pure substance;
- .3 the hazard class or division, subsidiary hazard(s), packing group, or physical state of the mixture or solution is different from that of the substance named in the Dangerous Goods List; or

**Part 3 – Dangerous Goods List, special provisions and exceptions**

- 3
- .4 the hazard characteristics and properties of the mixture or solution necessitate emergency response measures that are different from those required for the substance identified by name in the Dangerous Goods List.
- 3.1.3.3 Qualifying words such as “MIXTURE” or “SOLUTION”, as appropriate, shall be added as part of the proper shipping name, for example, “ACETONE SOLUTION”. In addition, the concentration of the mixture or solution may also be indicated after the basic description of the mixture or solution, for example, “ACETONE 75% SOLUTION”.
- 3.1.3.4 A mixture or solution meeting the classification criteria of this Code that is not identified by name in the Dangerous Goods List and that is composed of two or more dangerous goods shall be assigned to an entry that has the proper shipping name, description, hazard class or division, subsidiary hazard(s) and packing group that most precisely describe the mixture or solution.

**3.1.4 Segregation groups**

- 3.1.4.1 For the purpose of segregation, dangerous goods having certain similar chemical properties have been grouped together in segregation groups, see 7.2.5.
- 3.1.4.2 It is recognized that not all substances, mixtures, solutions or preparations falling within a segregation group are listed in the IMDG Code by name. These are shipped under N.O.S. entries. Although these N.O.S. entries are not themselves listed in the segregation groups (see 3.1.4.4), the consignor shall decide whether inclusion under the segregation group is appropriate and, if so, shall mention that fact in the transport document (see 5.4.1.5.11).
- 3.1.4.3 The segregation groups in this Code do not cover substances which fall outside the classification criteria of the Code. It is recognized that some non-hazardous substances have similar chemical properties as substances listed in the segregation groups. A consignor or the person responsible for packing the goods into a cargo transport unit who does have knowledge of the chemical properties of such non-dangerous goods may decide to implement the segregation provisions of a related segregation group on a voluntary basis.
- 3.1.4.4 The following segregation groups are identified.

**1 Acids (SGG1)**

|      |                                    |
|------|------------------------------------|
| 1052 | Hydrogen fluoride, anhydrous       |
| 1182 | Ethyl chloroformate                |
| 1183 | Ethylchlorosilane                  |
| 1238 | Methyl chloroformate               |
| 1242 | Methylchlorosilane                 |
| 1250 | Methyltrichlorosilane              |
| 1295 | Trichlorosilane                    |
| 1298 | Trimethylchlorosilane              |
| 1305 | Vinyltrichlorosilane               |
| 1572 | Cacodylic acid                     |
| 1595 | Dimethyl sulphate                  |
| 1715 | Acetic anhydride                   |
| 1716 | Acetyl bromide                     |
| 1717 | Acetyl chloride                    |
| 1718 | Butyl acid phosphate               |
| 1722 | Allyl chloroformate                |
| 1723 | Allyl iodide                       |
| 1724 | Allyltrichlorosilane, stabilized   |
| 1725 | Aluminium bromide, anhydrous       |
| 1726 | Aluminium chloride, anhydrous      |
| 1727 | Ammonium hydrogendifluoride, solid |
| 1728 | Amyltrichlorosilane                |
| 1729 | Anisoyl chloride                   |
| 1730 | Antimony pentachloride, liquid     |
| 1731 | Antimony pentachloride solution    |



|      |   |
|------|---|
| 1732 | Antimony pentafluoride                                  |
| 1733 | Antimony trichloride                                    |
| 1736 | Benzoyl chloride  |
| 1737 | Benzyl bromide  |
| 1738 | Benzyl chloride   |
| 1739 | Benzyl chloroformate                                    |
| 1740 | Hydrogendifluorides, n.o.s.                             |
| 1742 | Boron trifluoride acetic acid complex, liquid           |
| 1743 | Boron trifluoride propionic acid complex, liquid        |
| 1744 | Bromine or bromine solution                             |
| 1745 | Bromine pentafluoride                                   |
| 1746 | Bromine trifluoride                                     |
| 1747 | Butyltrichlorosilane                                    |
| 1750 | Chloroacetic acid solution                              |
| 1751 | Chloroacetic acid, solid                                |
| 1752 | Chloroacetyl chloride                                   |
| 1753 | Chlorophenyltrichlorosilane                             |
| 1754 | Chlorosulphonic acid (with or without sulphur trioxide) |
| 1755 | Chromic acid solution                                   |
| 1756 | Chromic fluoride, solid                                 |
| 1757 | Chromic fluoride solution                               |
| 1758 | Chromium oxychloride                                    |
| 1762 | Cyclohexenyltrichlorosilane                             |
| 1763 | Cyclohexyltrichlorosilane                               |
| 1764 | Dichloroacetic acid                                     |
| 1765 | Dichloroacetyl chloride                                 |
| 1766 | Dichlorophenyltrichlorosilane                           |
| 1767 | Diethyldichlorosilane                                   |
| 1768 | Difluorophosphoric acid, anhydrous                      |
| 1769 | Diphenyldichlorosilane                                  |
| 1770 | Diphenylmethyl bromide                                  |
| 1771 | Dodecyltrichlorosilane                                  |
| 1773 | Ferric chloride, anhydrous                              |
| 1775 | Fluoroboric acid  |
| 1776 | Fluorophosphoric acid, anhydrous                        |
| 1777 | Fluorosulphonic acid                                    |
| 1778 | Fluorosilicic acid                                      |
| 1779 | Formic acid with more than 85% acid by mass             |
| 1780 | Fumaryl chloride  |
| 1781 | Hexadecyltrichlorosilane                                |
| 1782 | Hexafluorophosphoric acid                               |
| 1784 | Hexyltrichlorosilane                                    |
| 1786 | Hydrofluoric acid and sulphuric acid mixture            |
| 1787 | Hydriodic acid  |
| 1788 | Hydrobromic acid  |
| 1789 | Hydrochloric acid                                       |
| 1790 | Hydrofluoric acid                                       |
| 1792 | Iodine monochloride, solid                              |
| 1793 | Isopropyl acid phosphate                                |
| 1794 | Lead sulphate with more than 3% free acid               |

**Part 3 – Dangerous Goods List, special provisions and exceptions**

|      |  |
|------|--|
| 1796 | Nitrating acid mixture   |
| 1798 | Nitrohydrochloric acid   |
| 1799 | Nonyltrichlorosilane   |
| 1800 | Octadecyltrichlorosilane   |
| 1801 | Octyltrichlorosilane   |
| 1802 | Perchloric acid with not more than 50% acid, by mass                   |
| 1803 | Phenolsulphonic acid, liquid   |
| 1804 | Phenyltrichlorosilane  |
| 1805 | Phosphoric acid, solution  |
| 1806 | Phosphorus pentachloride   |
| 1807 | Phosphorus pentoxide   |
| 1808 | Phosphorus tribromide  |
| 1809 | Phosphorus trichloride   |
| 1810 | Phosphorus oxychloride   |
| 1811 | Potassium hydrogendifluoride, solid                                    |
| 1815 | Propionyl chloride   |
| 1816 | Propyltrichlorosilane  |
| 1817 | Pyrosulphuryl chloride   |
| 1818 | Silicon tetrachloride  |
| 1826 | Nitrating acid mixture, spent  |
| 1827 | Stannic chloride, anhydrous  |
| 1828 | Sulphur chlorides  |
| 1829 | Sulphur trioxide, inhibited or sulphur trioxide, stabilized            |
| 1830 | Sulphuric acid with more than 51% acid                                 |
| 1831 | Sulphuric acid, fuming   |
| 1832 | Sulphuric acid, spent  |
| 1833 | Sulphurous acid  |
| 1834 | Sulphuryl chloride   |
| 1836 | Thionyl chloride   |
| 1837 | Thiophosphoryl chloride  |
| 1838 | Titanium tetrachloride   |
| 1839 | Trichloroacetic acid   |
| 1840 | Zinc chloride solution   |
| 1848 | Propionic acid with not less than 10% and less than 90% acid, by mass  |
| 1873 | Perchloric acid with more than 50% but not more than 72% acid, by mass |
| 1898 | Acetyl iodide  |
| 1902 | Diisooctyl acid phosphate  |
| 1905 | Selenic acid   |
| 1906 | Sludge acid  |
| 1938 | Bromoacetic acid solution  |
| 1939 | Phosphorus oxybromide  |
| 1940 | Thioglycolic acid  |
| 2031 | Nitric acid, other than red fuming                                     |
| 2032 | Nitric acid, red fuming  |
| 2214 | Phthalic anhydride with more than 0.05% of maleic anhydride            |
| 2215 | Maleic anhydride   |
| 2218 | Acrylic acid, inhibited  |
| 2225 | Benzenesulphonyl chloride  |
| 2226 | Benzotrichloride   |
| 2240 | Chromosulphuric acid   |

|      |   |
|------|---|
| 2262 | Dimethylcarbamoyl chloride  |
| 2267 | Dimethyl thiophosphoryl chloride  |
| 2305 | Nitrobenzenesulphonic acid  |
| 2308 | Nitrosylsulphuric acid, liquid  |
| 2331 | Zinc chloride, anhydrous  |
| 2353 | Butyryl chloride  |
| 2395 | Isobutyryl chloride   |
| 2407 | Isopropyl chloroformate   |
| 2434 | Dibenzylchlorosilane  |
| 2435 | Ethylphenyldichlorosilane   |
| 2437 | Methylphenyldichlorosilane  |
| 2438 | Trimethylacetyl chloride  |
| 2439 | Sodium hydrogendifluoride   |
| 2440 | Stannic chloride pentahydrate   |
| 2442 | Trichloroacetyl chloride  |
| 2443 | Vanadium oxytrichloride   |
| 2444 | Vanadium tetrachloride  |
| 2475 | Vanadium trichloride  |
| 2495 | Iodine pentafluoride  |
| 2496 | Propionic anhydride   |
| 2502 | Valeryl chloride  |
| 2503 | Zirconium tetrachloride   |
| 2506 | Ammonium hydrogen sulphate  |
| 2507 | Chloroplatinic acid, solid  |
| 2508 | Molybdenum pentachloride  |
| 2509 | Potassium hydrogen sulphate   |
| 2511 | 2-Chloropropionic acid  |
| 2513 | Bromoacetyl bromide   |
| 2531 | Methacrylic acid, stabilized  |
| 2564 | Trichloroacetic acid solution   |
| 2571 | Alkylsulphuric acids  |
| 2576 | Phosphorus oxybromide, molten   |
| 2577 | Phenylacetyl chloride   |
| 2578 | Phosphorus trioxide   |
| 2580 | Aluminium bromide solution  |
| 2581 | Aluminium chloride solution   |
| 2582 | Ferric chloride solution  |
| 2583 | Alkylsulphonic acids, solid or arylsulphonic acids, solid with more than 5% free sulphuric acid       |
| 2584 | Alkylsulphonic acids, liquid or arylsulphonic acids, liquid with more than 5% free sulphuric acid     |
| 2585 | Alkylsulphonic acids, solid or arylsulphonic acids, solid with not more than 5% free sulphuric acid   |
| 2586 | Alkylsulphonic acids, liquid or arylsulphonic acids, liquid with not more than 5% free sulphuric acid |
| 2604 | Boron trifluoride diethyl etherate  |
| 2626 | Chloric acid, aqueous solution with not more than 10% chloric acid                                    |
| 2642 | Fluoroacetic acid   |
| 2670 | Cyanuric chloride   |
| 2691 | Phosphorus pentabromide   |
| 2692 | Boron tribromide  |
| 2698 | Tetrahydrophthalic anhydrides with more than 0.05% maleic anhydride                                   |
| 2699 | Trifluoroacetic acid  |

## Part 3 – Dangerous Goods List, special provisions and exceptions

|      |   |
|------|---|
| 2739 | Butyric anhydride   |
| 2740 | Propyl chloroformate  |
| 2742 | Chloroformates, toxic, corrosive, flammable, n.o.s.                       |
| 2743 | <i>n</i> -Butyl chloroformate   |
| 2744 | Cyclobutyl chloroformate  |
| 2745 | Chloromethyl chloroformate  |
| 2746 | Phenyl chloroformate  |
| 2748 | 2-Ethylhexyl chloroformate  |
| 2751 | Diethylthiophosphoryl chloride  |
| 2789 | Acetic acid, glacial or acetic acid solution, more than 80% acid, by mass |
| 2790 | Acetic acid solution, more than 10% but not more than 80% acid, by mass   |
| 2794 | Batteries, wet, filled with acid electric storage                         |
| 2796 | Sulphuric acid with not more than 51% acid or battery fluid, acid         |
| 2798 | Phenylphosphorus dichloride   |
| 2799 | Phenylphosphorus thiodichloride   |
| 2802 | Copper chloride   |
| 2817 | Ammonium hydrogendifluoride solution                                      |
| 2819 | Amyl acid phosphate   |
| 2820 | Butyric acid  |
| 2823 | Crotonic acid, solid  |
| 2826 | Ethyl chlorothioformate   |
| 2829 | Caproic acid  |
| 2834 | Phosphorous acid  |
| 2851 | Boron trifluoride dihydrate   |
| 2865 | Hydroxylamine sulphate  |
| 2869 | Titanium trichloride mixture  |
| 2879 | Selenium oxychloride  |
| 2967 | Sulphamic acid  |
| 2985 | Chlorosilanes, flammable, corrosive, n.o.s.                               |
| 2986 | Chlorosilanes, corrosive, flammable, n.o.s.                               |
| 2987 | Chlorosilanes, corrosive, n.o.s.  |
| 2988 | Chlorosilanes, water-reactive, flammable, corrosive, n.o.s.               |
| 3246 | Methanesulphonyl chloride   |
| 3250 | Chloroacetic acid, molten   |
| 3260 | Corrosive solid, acidic, inorganic, n.o.s.                                |
| 3261 | Corrosive solid, acidic, organic, n.o.s.                                  |
| 3264 | Corrosive liquid, acidic, inorganic, n.o.s.                               |
| 3265 | Corrosive liquid, acidic, organic, n.o.s.                                 |
| 3277 | Chloroformates, toxic, corrosive, n.o.s.                                  |
| 3361 | Chlorosilanes, toxic, corrosive, n.o.s.                                   |
| 3362 | Chlorosilanes, toxic, corrosive, flammable, n.o.s.                        |
| 3412 | Formic acid with not less than 10% but not more than 85% acid by mass     |
| 3412 | Formic acid with not less than 5% but not more than 10% acid by mass      |
| 3419 | Boron trifluoride acetic acid complex, solid                              |
| 3420 | Boron trifluoride propionic acid complex, solid                           |
| 3421 | Potassium hydrogendifluoride solution                                     |
| 3425 | Bromoacetic acid, solid   |
| 3453 | Phosphoric acid, solid  |
| 3456 | Nitrosylsulphuric acid, solid   |
| 3463 | Propionic acid with not less than 90% acid by mass                        |

- 3472 Crotonic acid, liquid  
3498 Iodine monochloride, liquid
- 2 Ammonium compounds (SGG2)**
- 0004 Ammonium picrate dry or wetted with less than 10% water, by mass  
0222 Ammonium nitrate, with more than 0.2% combustible substances  
0402 Ammonium perchlorate  
1310 Ammonium picrate, wetted with not less than 10% water, by mass  
1439 Ammonium dichromate  
1442 Ammonium perchlorate  
1444 Ammonium persulphate  
1546 Ammonium arsenate  
1630 Mercury ammonium chloride  
1727 Ammonium hydrogendifluoride, solid
- 1835 Tetramethylammonium hydroxide aqueous solution with more than 2.5% but less than 25% tetramethylammonium hydroxide
- △ 1835 Tetramethylammonium hydroxide aqueous solution with not more than 2.5% tetramethylammonium hydroxide
- 1843 Ammonium dinitro-*o*-cresolate, solid  
1942 Ammonium nitrate with not more than 0.2% combustible substances  
2067 Ammonium nitrate based fertilizer  
2071 Ammonium nitrate based fertilizer  
2073 Ammonia solution, relative density less than 0.880 at 15°C in water, with more than 35% but not more than 50% ammonia  
2426 Ammonium nitrate, liquid (hot concentrated solution)  
2505 Ammonium fluoride  
2506 Ammonium hydrogen sulphate  
2683 Ammonium sulphide solution  
2687 Dicyclohexylammonium nitrite  
2817 Ammonium hydrogendifluoride solution  
2818 Ammonium polysulphide solution  
2854 Ammonium fluorosilicate  
2859 Ammonium metavanadate  
2861 Ammonium polyvanadate  
2863 Sodium ammonium vanadate  
3375 Ammonium nitrate emulsion or suspension or gel, intermediate for blasting explosives  
3423 Tetramethylammonium hydroxide, solid  
3424 Ammonium dinitro-*o*-cresolate solution
- 3560 Tetramethylammonium hydroxide aqueous solution with not less than 25% tetramethylammonium hydroxide
- 3 Bromates (SGG3)**
- 1450 Bromates, inorganic, n.o.s.  
1473 Magnesium bromate  
1484 Potassium bromate  
1494 Sodium bromate  
2469 Zinc bromate  
2719 Barium bromate  
3213 Bromates, inorganic, aqueous solution, n.o.s.
- 4 Chlorates (SGG4)**
- 1445 Barium chlorate, solid  
1452 Calcium chlorate

**Part 3 – Dangerous Goods List, special provisions and exceptions**

- 3**
- 1458 Chlorate and borate mixture
  - 1459 Chlorate and magnesium chloride mixture, solid
  - 1461 Chlorates, inorganic, n.o.s.
  - 1485 Potassium chlorate
  - 1495 Sodium chlorate
  - 1506 Strontium chlorate
  - 1513 Zinc chlorate
  - 2427 Potassium chlorate, aqueous solution
  - 2428 Sodium chlorate, aqueous solution
  - 2429 Calcium chlorate, aqueous solution
  - 2573 Thallium chlorate
  - 2721 Copper chlorate
  - 2723 Magnesium chlorate
  - 3405 Barium chlorate solution
  - 3407 Chlorate and magnesium chloride mixture solution
- 5 Chlorites (SGG5)**
- 1453 Calcium chlorite
  - 1462 Chlorites, inorganic, n.o.s.
  - 1496 Sodium chlorite
  - 1908 Chlorite solution
- 6 Cyanides (SGG6)**
- 1541 Acetone cyanhydrin, stabilized
  - 1565 Barium cyanide
  - 1575 Calcium cyanide
  - 1587 Copper cyanide
  - 1588 Cyanides, inorganic, solid, n.o.s.
  - 1620 Lead cyanide
  - 1626 Mercuric potassium cyanide
  - 1636 Mercury cyanide
  - 1642 Mercury oxycyanide, desensitized
  - 1653 Nickel cyanide
  - 1679 Potassium cuprocyanide
  - 1680 Potassium cyanide, solid
  - 1684 Silver cyanide
  - 1689 Sodium cyanide, solid
  - 1694 Bromobenzyl cyanides, liquid
  - 1713 Zinc cyanide
  - 1889 Cyanogen bromide
  - 1935 Cyanide solution, n.o.s.
  - 2205 Adiponitrile
  - 2316 Sodium cuprocyanide, solid
  - 2317 Sodium cuprocyanide solution
  - 3413 Potassium cyanide solution
  - 3414 Sodium cyanide solution
  - 3449 Bromobenzyl cyanides, solid
- 7 Heavy metals and their salts (including their organometallic compounds) (SGG7)**
- 0129 Lead azide, wetted, with not less than 20% water, or mixture of alcohol and water, by mass
  - 0130 Lead styphnate (lead trinitroresorcinate), wetted with not less than 20% water, or mixture of alcohol and water, by mass

|      |  |
|------|--|
| 0135 | Mercury fulminate, wetted with not less than 20% water, or mixture of alcohol and water, by mass |
| 1347 | Silver picrate, wetted with not less than 30% water, by mass                                     |
| 1389 | Alkali metal amalgam, liquid   |
| 1392 | Alkaline earth metal amalgam, liquid   |
| 1435 | Zinc ashes   |
| 1436 | Zinc dust or zinc powder   |
| 1469 | Lead nitrate   |
| 1470 | Lead perchlorate, solid  |
| 1493 | Silver nitrate   |
| 1513 | Zinc chlorate  |
| 1514 | Zinc nitrate   |
| 1515 | Zinc permanganate  |
| 1516 | Zinc peroxide  |
| 1587 | Copper cyanide   |
| 1616 | Lead acetate   |
| 1617 | Lead arsenates   |
| 1618 | Lead arsenites   |
| 1620 | Lead cyanide   |
| 1623 | Mercuric arsenate  |
| 1624 | Mercuric chloride  |
| 1625 | Mercuric nitrate   |
| 1626 | Mercuric potassium cyanide   |
| 1627 | Mercurous nitrate  |
| 1629 | Mercury acetate  |
| 1630 | Mercury ammonium chloride  |
| 1631 | Mercury benzoate   |
| 1634 | Mercury bromides   |
| 1636 | Mercury cyanide  |
| 1637 | Mercury gluconate  |
| 1638 | Mercury iodide   |
| 1639 | Mercury nucleate   |
| 1640 | Mercury oleate   |
| 1641 | Mercury oxide  |
| 1642 | Mercury oxycyanide, desensitized   |
| 1643 | Mercury potassium iodide   |
| 1644 | Mercury salicylate   |
| 1645 | Mercury sulphate   |
| 1646 | Mercury thiocyanate  |
| 1649 | Motor fuel anti-knock mixture  |
| 1653 | Nickel cyanide   |
| 1674 | Phenylmercuric acetate   |
| 1683 | Silver arsenite  |
| 1684 | Silver cyanide   |
| 1712 | Zinc arsenate and zinc arsenite mixture  |
| 1713 | Zinc cyanide   |
| 1714 | Zinc phosphide   |
| 1794 | Lead sulphate with more than 3% free acid  |
| 1838 | Titanium tetrachloride   |
| 1840 | Zinc chloride solution   |
| 1872 | Lead dioxide   |



## Part 3 – Dangerous Goods List, special provisions and exceptions

|      |  |
|------|--|
| 1894 | Phenylmercuric hydroxide   |
| 1895 | Phenylmercuric nitrate   |
| 1931 | Zinc dithionite  |
| 1931 | Zinc hydrosulphite   |
| 2024 | Mercury compound, liquid, n.o.s.   |
| 2025 | Mercury compound, solid, n.o.s.  |
| 2026 | Phenylmercuric compound, n.o.s.  |
| 2291 | Lead compound, soluble, n.o.s.   |
| 2331 | Zinc chloride, anhydrous   |
| 2441 | Titanium trichloride, pyrophoric or titanium trichloride mixture, pyrophoric |
| 2469 | Zinc bromate   |
| 2546 | Titanium powder, dry   |
| 2714 | Zinc resinate  |
| 2777 | Mercury based pesticide, solid, toxic  |
| 2778 | Mercury based pesticide, liquid, flammable, toxic                            |
| 2809 | Mercury  |
| 2855 | Zinc fluorosilicate  |
| 2869 | Titanium trichloride mixture   |
| 2878 | Titanium, sponge granules or titanium, sponge powders                        |
| 2881 | Metal catalyst, dry  |
| 2989 | Lead phosphite, dibasic  |
| 3011 | Mercury based pesticide, liquid, toxic, flammable                            |
| 3012 | Mercury based pesticide, liquid, toxic                                       |
| 3089 | Metal powder, flammable, n.o.s.  |
| 3174 | Titanium disulphide  |
| 3181 | Metal salts of organic compounds, flammable, n.o.s.                          |
| 3189 | Metal powder, self-heating, n.o.s.   |
| 3401 | Alkali metal amalgam, solid  |
| 3402 | Alkaline earth metal amalgam, solid  |
| 3408 | Lead perchlorate solution  |
| 3483 | Motor fuel anti-knock mixture, flammable                                     |

**8 Hypochlorites (SGG8)**

|      |   |
|------|---|
| 1471 | Lithium hypochlorite  |
| 1748 | Calcium hypochlorite, dry or calcium hypochlorite mixture, dry with more than 39% available chlorine (8.8% available oxygen)                        |
| 1791 | Hypochlorite solution   |
| 2208 | Calcium hypochlorite mixture, dry with more than 10% but not more than 39% available chlorine   |
| 2741 | Barium hypochlorite with more than 22% available chlorine   |
| 2880 | Calcium hypochlorite, hydrated or calcium hypochlorite, hydrated mixture with not less than 5.5% but not more than 16% water                        |
| 3212 | Hypochlorites, inorganic, n.o.s.  |
| 3255 | <i>tert</i> -Butyl hypochlorite   |
| 3485 | Calcium hypochlorite, dry, corrosive or calcium hypochlorite mixture, dry, corrosive with more than 39% available chlorine (8.8% available oxygen)  |
| 3486 | Calcium hypochlorite mixture, dry, corrosive with more than 10% but not more than 39% available chlorine  |
| 3487 | Calcium hypochlorite, hydrated, corrosive or calcium hypochlorite, hydrated mixture, corrosive, with not less than 5.5% but not more than 16% water |

**9 Lead and its compounds (SGG9)**

|      |   |
|------|---|
| 0129 | Lead azide, wetted with not less than 20% water, or mixture of alcohol and water, by mass |
|------|---|

- 0130 Lead styphnate, wetted with not less than 20% water, or mixture of alcohol and water, by mass
- 0130 Lead trinitroresorcinate, wetted with not less than 20% water, or mixture of alcohol and water, by mass
- 1469 Lead nitrate
- 1470 Lead perchlorate, solid
- 1616 Lead acetate
- 1617 Lead arsenates
- 1618 Lead arsenites
- 1620 Lead cyanide
- 1649 Motor fuel anti-knock mixture
- 1794 Lead sulphate with more than 3% free acid
- 1872 Lead dioxide
- 2291 Lead compound, soluble, n.o.s.
- 2989 Lead phosphide, dibasic
- 3408 Lead perchlorate solution
- 3483 Motor fuel anti-knock mixture, flammable
- 10 Liquid halogenated hydrocarbons (SGG10)**
- 1099 Allyl bromide
- 1100 Allyl chloride
- 1107 Amyl chloride
- 1126 1-Bromobutane
- 1127 Chlorobutanes
- 1134 Chlorobenzene
- 1150 1,2-Dichloroethylene
- 1152 Dichloropentanes
- 1184 Ethylene dichloride
- 1278 1-Chloropropane
- 1279 1,2-Dichloropropane
- 1303 Vinylidene chloride, stabilized
- 1591 *o*-Dichlorobenzene
- 1593 Dichloromethane
- 1605 Ethylene dibromide
- 1647 Methyl bromide and ethylene dibromide mixture, liquid
- 1669 Pentachloroethane
- 1701 Xylyl bromide
- 1702 1,1,2,2-Tetrachloroethane
- 1710 Trichloroethylene
- 1723 Allyl iodide
- 1737 Benzyl bromide
- 1738 Benzyl chloride
- 1846 Carbon tetrachloride
- 1887 Bromochloromethane
- 1888 Chloroform
- 1891 Ethyl bromide
- 1897 Tetrachloroethylene
- 1991 Chloroprene, stabilized
- 2234 Chlorobenzotrifluorides
- 2238 Chlorotoluenes
- 2279 Hexachlorobutadiene
- 2321 Trichlorobenzenes, liquid

**Part 3 – Dangerous Goods List, special provisions and exceptions****3**

|      |                           |
|------|---------------------------|
| 2322 | Trichlorobutene           |
| 2339 | 2-Bromobutane             |
| 2341 | 1-Bromo-3-methylbutane    |
| 2342 | Bromomethylpropanes       |
| 2343 | 2-Bromopentane            |
| 2344 | Bromopropanes             |
| 2356 | 2-Chloropropane           |
| 2362 | 1,1-Dichloroethane        |
| 2387 | Fluorobenzene             |
| 2388 | Fluorotoluenes            |
| 2390 | 2-Iodobutane              |
| 2391 | Iodomethylpropanes        |
| 2392 | Iodopropanes              |
| 2456 | 2-Chloropropene           |
| 2504 | Tetrabromoethane          |
| 2515 | Bromoform                 |
| 2554 | Methylallyl chloride      |
| 2644 | Methyl iodide             |
| 2646 | Hexachlorocyclopentadiene |
| 2664 | Dibromomethane            |
| 2688 | 1-Bromo-3-chloropropane   |
| 2831 | 1,1,1-Trichloroethane     |
| 2872 | Dibromochloropropanes     |

**11 Mercury and mercury compounds (SGG11)**

|      |  |
|------|--|
| 0135 | Mercury fulminate, wetted with not less than 20% water, or mixture of alcohol and water, by mass |
| 1389 | Alkali metal amalgam, liquid   |
| 1392 | Alkaline earth metal amalgam, liquid   |
| 1623 | Mercuric arsenate  |
| 1624 | Mercuric chloride  |
| 1625 | Mercuric nitrate   |
| 1626 | Mercuric potassium cyanide   |
| 1627 | Mercurous nitrate  |
| 1629 | Mercury acetate  |
| 1630 | Mercury ammonium chloride  |
| 1631 | Mercury benzoate   |
| 1634 | Mercury bromides   |
| 1636 | Mercury cyanide  |
| 1637 | Mercury gluconate  |
| 1638 | Mercury iodide   |
| 1639 | Mercury nucleate   |
| 1640 | Mercury oleate   |
| 1641 | Mercury oxide  |
| 1642 | Mercury oxycyanide, desensitized   |
| 1643 | Mercury potassium iodide   |
| 1644 | Mercury salicylate   |
| 1645 | Mercury sulphate   |
| 1646 | Mercury thiocyanate  |
| 1894 | Phenylmercuric hydroxide   |
| 1895 | Phenylmercuric nitrate   |

- 2024 Mercury compound, liquid, n.o.s.  
2025 Mercury compound, solid, n.o.s.  
2026 Phenylmercuric compound, n.o.s.  
2777 Mercury based pesticide, solid, toxic  
2778 Mercury based pesticide, liquid, flammable, toxic  
2809 Mercury  
3011 Mercury based pesticide, liquid, toxic, flammable  
3012 Mercury based pesticide, liquid, toxic  
3401 Alkali metal amalgam, solid  
3402 Alkaline earth metal amalgam, solid
- 12 Nitrites and their mixtures (SGG12)**  
1487 Potassium nitrate and sodium nitrite mixture  
1488 Potassium nitrite  
1500 Sodium nitrite  
2627 Nitrites, inorganic, n.o.s.  
2726 Nickel nitrite  
3219 Nitrites, inorganic, aqueous solution, n.o.s.
- 13 Perchlorates (SGG13)**  
1442 Ammonium perchlorate  
1447 Barium perchlorate, solid  
1455 Calcium perchlorate  
1470 Lead perchlorate, solid  
1475 Magnesium perchlorate  
1481 Perchlorates, inorganic, n.o.s.  
1489 Potassium perchlorate  
1502 Sodium perchlorate  
1508 Strontium perchlorate  
3211 Perchlorates, inorganic, aqueous solution, n.o.s.  
3406 Barium perchlorate solution  
3408 Lead perchlorate solution
- 14 Permanganates (SGG14)**  
1448 Barium permanganate  
1456 Calcium permanganate  
1482 Permanganates, inorganic, n.o.s.  
1490 Potassium permanganate  
1503 Sodium permanganate  
1515 Zinc permanganate  
3214 Permanganates, inorganic, aqueous solution, n.o.s.
- 15 Powdered metals (SGG15)**  
1309 Aluminium powder, coated  
1326 Hafnium powder, wetted with not less than 25% water  
1352 Titanium powder, wetted with not less than 25% water  
1358 Zirconium powder, wetted with not less than 25% water  
1383 Pyrophoric alloy or pyrophoric metal, n.o.s.  
1396 Aluminium powder, uncoated  
1398 Aluminium silicon powder, uncoated  
1418 Magnesium powder or magnesium alloys powder  
1435 Zinc ashes  
1436 Zinc dust or zinc powder  
1854 Barium alloys, pyrophoric

**Part 3 – Dangerous Goods List, special provisions and exceptions**

- 2008 Zirconium powder, dry  
 2009 Zirconium, dry, sheets, strip or coiled wire  
 2545 Hafnium powder, dry  
 2546 Titanium powder, dry  
 2878 Titanium sponge powders  
 2881 Metal catalyst, dry  
 2950 Magnesium granules, coated, particle size not less than 149 microns  
 3078 Cerium, turnings or gritty powder  
 3089 Metal powder, flammable, n.o.s.  
 3170 Aluminium smelting by-products or aluminium remelting by-products  
 3189 Metal powder, self-heating, n.o.s.

**16 Peroxides (SGG16)**

- 1449 Barium peroxide  
 1457 Calcium peroxide  
 1472 Lithium peroxide  
 1476 Magnesium peroxide  
 1483 Peroxides, inorganic, n.o.s.  
 1491 Potassium peroxide  
 1504 Sodium peroxide  
 1509 Strontium peroxide  
 1516 Zinc peroxide  
 2014 Hydrogen peroxide, aqueous solution, 20–60%  
 2015 Hydrogen peroxide, aqueous solution, stabilized  
 2466 Potassium superoxide  
 2547 Sodium superoxide  
 3149 Hydrogen peroxide and peroxyacetic acid mixture  
 3377 Sodium perborate monohydrate  
 3378 Sodium carbonate peroxyhydrate

**17 Azides (SGG17)**

- 0129 Lead azide, wetted with not less than 20% water, or mixture of alcohol and water, by mass  
 0224 Barium azide, dry or wetted with less than 50% water, by mass  
 1571 Barium azide, wetted with not less than 50% water, by mass  
 1687 Sodium azide

**18 Alkalis (SGG18)**

- 1005 Ammonia, anhydrous  
 1160 Dimethylamine, aqueous solution  
 1163 Dimethylhydrazine, unsymmetrical  
 1235 Methylamine, aqueous solution  
 1244 Methylhydrazine  
 1289 Sodium methylate solution in alcohol  
 1382 Potassium sulphide, anhydrous or potassium sulphide with less than 30% water of crystallization  
 1385 Sodium sulphide, anhydrous or sodium sulphide with less than 30% water of crystallization  
 1431 Sodium methylate  
 1604 Ethylenediamine  
 1719 Caustic alkali liquid, n.o.s.  
 1813 Potassium hydroxide, solid  
 1814 Potassium hydroxide solution  
 1819 Sodium aluminate solution  
 1823 Sodium hydroxide, solid  
 1824 Sodium hydroxide solution

|        |   |
|--------|---|
| 1825   | Sodium monoxide   |
| ■ 1835 | Tetramethylammonium hydroxide aqueous solution with more than 2.5% but less than 25% tetramethylammonium hydroxide                    |
| △ 1835 | Tetramethylammonium hydroxide aqueous solution with not more than 2.5% tetramethylammonium hydroxide                                  |
| 1847   | Potassium sulphide, hydrated with not less than 30% water of crystallization  |
| 1849   | Sodium sulphide, hydrated with not less than 30% water  |
| 1907   | Soda lime with more than 4% sodium hydroxide  |
| 1922   | Pyrrolidine   |
| 2029   | Hydrazine, anhydrous  |
| 2030   | Hydrazine, aqueous solution with more than 37% hydrazine, by mass   |
| 2033   | Potassium monoxide  |
| 2073   | Ammonia solution, relative density less than 0.880 at 15°C in water, with more than 35% but not more than 50% ammonia                 |
| 2079   | Diethylenetriamine  |
| 2259   | Triethylenetetramine  |
| 2270   | Ethylamine, aqueous solution, with not less than 50% but not more than 70% ethylamine   |
| 2318   | Sodium hydrosulphide with less than 25% water of crystallization  |
| 2320   | Tetraethylenepentamine  |
| 2379   | 1,3-Dimethylbutylamine  |
| 2382   | Dimethylhydrazine, symmetrical  |
| 2386   | 1-Ethylpiperidine   |
| 2399   | 1-Methylpiperidine  |
| 2401   | Piperidine  |
| 2491   | Ethanolamine or ethanolamine solution   |
| 2579   | Piperazine  |
| 2671   | Aminopyridines ( <i>o</i> -, <i>m</i> -, <i>p</i> -)  |
| 2672   | Ammonia solution relative density between 0.880 and 0.957 at 15°C in water, with more than 10% but not more than 35% ammonia, by mass |
| 2677   | Rubidium hydroxide solution   |
| 2678   | Rubidium hydroxide  |
| 2679   | Lithium hydroxide solution  |
| 2680   | Lithium hydroxide   |
| 2681   | Caesium hydroxide solution  |
| 2682   | Caesium hydroxide   |
| 2683   | Ammonium sulphide solution  |
| 2733   | Amines, flammable, corrosive, n.o.s. or polyamines, flammable, corrosive, n.o.s.  |
| 2734   | Amines, liquid, corrosive, flammable, n.o.s. or polyamines, liquid, corrosive, flammable, n.o.s.                                      |
| 2735   | Amines, liquid, corrosive, n.o.s. or polyamines, liquid, corrosive, n.o.s.  |
| 2795   | Batteries, wet, filled with alkali, electric storage  |
| 2797   | Battery fluid, alkali   |
| 2818   | Ammonium polysulphide solution  |
| 2949   | Sodium hydrosulphide, hydrated with not less than 25% water of crystallization  |
| 3028   | Batteries, dry, containing potassium hydroxide, solid electric storage  |
| 3073   | Vinylpyridines, stabilized  |
| 3206   | Alkali metal alcoholates, self-heating, corrosive, n.o.s.   |
| 3253   | Disodium trioxosilicate   |
| 3259   | Amines, solid, corrosive, n.o.s. or polyamines, solid, corrosive, n.o.s.  |
| 3262   | Corrosive solid, basic, inorganic, n.o.s.   |
| 3263   | Corrosive solid, basic, organic, n.o.s.   |
| 3266   | Corrosive liquid, basic, inorganic, n.o.s.  |

**Part 3 – Dangerous Goods List, special provisions and exceptions**

---

- 3
- 3267 Corrosive liquid, basic, organic, n.o.s.
  - 3274 Alcoholates solution, n.o.s. in alcohol
  - 3293 Hydrazine, aqueous solution with not more than 37% hydrazine, by mass
  - 3318 Ammonia solution, relative density less than 0.880 at 15°C in water, with more than 50% ammonia
  - 3320 Sodium borohydride and sodium hydroxide solution with not more than 12% sodium borohydride and not more than 40% sodium hydroxide, by mass
  - 3423 Tetramethylammonium hydroxide, solid
  - 3484 Hydrazine aqueous solution, flammable, with more than 37% hydrazine, by mass
  - 3560 Tetramethylammonium hydroxide aqueous solution with not less than 25% tetramethylammonium hydroxide



## Chapter 3.2

### *Dangerous Goods List*

#### 3.2.1 Structure of the Dangerous Goods List

The Dangerous Goods List is divided into 18 columns as follows:

- Column 1    **UN No.** – this column contains the United Nations number assigned to a dangerous good by the United Nations Sub-Committee of Experts on the Transport of Dangerous Goods (UN List).
- Column 2    **Proper shipping name (PSN)** – this column contains the proper shipping names in upper-case characters, which may have to be followed by additional descriptive text in lower-case characters (see 3.1.2). Proper shipping names may be shown in plural where isomers of similar classification exist. Hydrates may be included under the proper shipping name for the anhydrous substances. Unless otherwise indicated for an entry in the Dangerous Goods List, the word “SOLUTION” in a proper shipping name means one or more named dangerous goods dissolved in a liquid that is not otherwise subject to this Code. When a flashpoint is mentioned in this column, the data is based on closed-cup (c.c.) methods.
- Column 3    **Class or division** – this column contains the class and, in the case of class 1, the division and the compatibility group assigned to the substance or article according to the classification system described in part 2, chapter 2.1.
- Column 4    **Subsidiary hazard(s)** – this column contains the class number(s) of any subsidiary hazard(s) which have been identified by applying the classification system described in part 2. This column also identifies a dangerous good as a marine pollutant as follows:
- P – Marine pollutant: a non-exhaustive list of known marine pollutants, based on previous criteria and assignment. The absence of the symbol P or the presence of a “-” in that column does not preclude the application of 2.10.3.
- △ Column 5    **Packing group** – this column contains the packing group number (i.e. I, II or III) where assigned to the substance. If more than one packing group is indicated for the entry, the packing group of the substance or formulation to be transported shall be determined, based on its properties, through application of the hazard grouping criteria as provided in part 2.
- Column 6    **Special provisions** – this column contains a number referring to any special provision(s) indicated in chapter 3.3 that is relevant to the substance or article. Special provisions apply to all packing groups permitted for a particular substance or article unless the wording makes it otherwise apparent. The special provision numbers specific to the sea mode start from 900.
- Note:** When a special provision is no longer needed, this special provision is deleted but the special provision number is not allocated again, in order not to confuse the users of this Code. For this reason, some of the numbers are missing.
- Column 7a    **Limited quantities** – this column provides the maximum quantity per inner packaging or article for transporting dangerous goods as limited quantities in accordance with chapter 3.4.
- Column 7b    **Excepted quantities** – this column provides an alpha-numeric code described in subsection 3.5.1.2 which indicates the maximum quantity per inner and outer packaging for transporting dangerous goods as excepted quantities in accordance with chapter 3.5.
- Column 8    **Packing instructions** – this column contains alpha-numeric codes which refer to the relevant packing instruction(s) in 4.1.4. The packing instructions indicate the packagings (including large packagings) which may be used for the transport of substances and articles.
- A code including the letter “P” refers to packing instructions for the use of packagings described in chapter 6.1, 6.2 or 6.3.

## Part 3 – Dangerous Goods List, special provisions and exceptions

- A code including the letters “LP” refers to packing instructions for the use of large packagings described in chapter 6.6.
- When a code including the letter(s) “P” or “LP” is not provided, it means that the substance is not allowed in that type of packaging.
- Column 9 **Special packing provisions** – this column contains alpha-numeric codes which refer to the relevant special packing provisions specified in 4.1.4. The special packing provisions indicate the packagings (including large packagings).
- A special packing provision including the letters “PP” refers to a special packing provision applicable to the use of a packing instruction bearing the Code “P” in 4.1.4.1.
- A special packing provision including the letter “L” refers to a special packing provision applicable to a packing instruction bearing the code “LP” in 4.1.4.3.
- Column 10 **IBC packing instructions** – this column contains alpha-numeric codes that refer to the relevant IBC instruction, which indicates the type of IBC that shall be used for the transport of the substance under reference. A code including the letters “IBC” refers to packing instructions for the use of IBCs described in chapter 6.5. When a code is not provided, it means the substance is not authorized in IBC.
- Column 11 **IBC special provisions** – this column contains an alpha-numeric code, including the letter “B”, which refers to special packing provisions applicable to the use of packing instructions bearing the code “IBC” in 4.1.4.2.
- Column 12 [Reserved]
- Column 13 **Tank and bulk container instructions** – this column contains T codes (see 4.2.5.2.6) applicable to the transport of dangerous goods in portable tanks and road tank vehicles.
- When a T code is not provided in this column, it means that the dangerous goods are not authorized for transport in tanks unless specifically approved by the competent authority.
- A code including the letters “BK” refers to the type of bulk containers used for the transport of bulk goods described in chapters 4.3 and 6.9.
- The gases authorized for transport in MEGCs are indicated in the column “MEGC” in tables 1 and 2 of packing instruction P200 in 4.1.4.1.
- Column 14 **Tank special provisions** – this column contains TP notes (see 4.2.5.3) applicable to the transport of dangerous goods in portable tanks and road tank vehicles. The TP notes specified in this column apply to the portable tanks specified in column 13.
- Column 15 **EmS** – this column refers to the relevant emergency schedules for FIRE and SPILLAGE in “The EmS Guide – Revised Emergency Response Procedures for Ships Carrying Dangerous Goods”.
- The first EmS code refers to the relevant Fire Schedule (e.g. Fire Schedule Alfa “F-A” General Fire Schedule).
- The second EmS code refers to the relevant Spillage Schedule (e.g. Spillage Schedule Alfa “S-A” Toxic Substances).
- Underlined EmS codes (special cases) indicate a substance, material or article for which additional advice is given in the emergency response procedures.
- For dangerous goods offered for transport under N.O.S. entries or other generic entries, the most relevant emergency response procedures may vary with the properties of the hazardous constituents. As a consequence, shippers may have to declare different EmS codes from those indicated, if, to their knowledge, such codes are more appropriate.
- The provisions in this column are not mandatory.
- Column 16a **Stowage and handling** – this column contains the stowage and handling codes as specified in 7.1.5 and 7.1.6.
- Column 16b **Segregation** – this column contains the segregation group codes as specified in 7.2.5.2 and the segregation codes as specified in 7.2.8.
- Column 17 **Properties and observations** – this column contains properties of and observations on the dangerous goods listed. The provisions in this column are not mandatory.
- Properties of most gases include an indication of its density in relation to air. The figures in brackets give the density relative to air.
- .1 “lighter than air” when the vapour density is down to half that of air;

- .2 “much lighter than air” when the vapour density is less than half that of air;
- .3 “heavier than air” when the vapour density is up to twice that of air; and
- .4 “much heavier than air” when the vapour density is more than twice that of air.

When explosive limits are given, these refer to the volume percentage of the vapour of the substance when mixed with air.

The ease and extent to which different liquids mix with water varies greatly and most entries have included an indication of miscibility. In these cases “miscible with water” normally means capable of being mixed with water in all proportions to form a completely homogeneous liquid.

Column 18 UN No. – see column 1.

### 3.2.2 Abbreviations and symbols

The following abbreviations and symbols are used in the Dangerous Goods List and have the meanings shown:

| Abbreviation/symbol | Column | Meaning                 |
|---------------------|--------|-------------------------|
| N.O.S.              | 2      | Not otherwise specified |
| P                   | 4      | Marine pollutant        |





# **Dangerous Goods List**

Part 3 – Dangerous Goods List, special provisions and exceptions

Chapter 3.2 – Dangerous Goods List

| UN No. | Proper shipping name (PSN)  | Class or division | Subsidiary hazard(s) | Packing group  | Special provisions | Limited and excepted quantity provisions |                     | Packing              |              | IBC           |               |
|--------|---|-------------------|----------------------|----------------|--------------------|--|---------------------|----------------------|--------------|---------------|---------------|
|        |   |                   |                      |                |                    | Limited quantities                       | Excepted quantities | Instructions         | Provisions   | Instructions  | Provisions    |
| (1)    | (2)<br>3.1.2  | (3)<br>2.0        | (4)<br>2.0           | (5)<br>2.0.1.3 | (6)<br>3.3         | (7a)<br>3.4                              | (7b)<br>3.5         | (8)<br>4.1.4         | (9)<br>4.1.4 | (10)<br>4.1.4 | (11)<br>4.1.4 |
| 0004   | AMMONIUM PICRATE dry or wetted with less than 10% water, by mass                              | 1.1D              | -                    | -              | -                  | 0  | E0                  | P112 (a), (b) or (c) | PP26         | -             | -             |
| 0005   | CARTRIDGES FOR WEAPONS with bursting charge   | 1.1F              | -                    | -              | -                  | 0  | E0                  | P130 LP101           | -            | -             | -             |
| 0006   | CARTRIDGES FOR WEAPONS with bursting charge   | 1.1E              | -                    | -              | -                  | 0  | E0                  | P130 LP101           | PP67 L1      | -             | -             |
| 0007   | CARTRIDGES FOR WEAPONS with bursting charge   | 1.2F              | -                    | -              | -                  | 0  | E0                  | P130 LP101           | -            | -             | -             |
| 0009   | AMMUNITION, INCENDIARY with or without burster, expelling charge or propelling charge         | 1.2G              | -                    | -              | -                  | 0  | E0                  | P130 LP101           | PP67 L1      | -             | -             |
| 0010   | AMMUNITION, INCENDIARY with or without burster, expelling charge or propelling charge         | 1.3G              | -                    | -              | -                  | 0  | E0                  | P130 LP101           | PP67 L1      | -             | -             |
| 0012   | CARTRIDGES FOR WEAPONS, INERT PROJECTILE or CARTRIDGES, SMALL ARMS                            | 1.4S              | -                    | -              | 364                | 5 kg                                     | E0                  | P130 LP101           | -            | -             | -             |
| 0014   | CARTRIDGES FOR WEAPONS, BLANK or CARTRIDGES, SMALL ARMS, BLANK or CARTRIDGES FOR TOOLS, BLANK | 1.4S              | -                    | -              | 364                | 5 kg                                     | E0                  | P130 LP101           | -            | -             | -             |
| 0015   | AMMUNITION, SMOKE with or without burster, expelling charge or propelling charge              | 1.2G              | See SP204            | -              | 204                | 0  | E0                  | P130 LP101           | PP67 L1      | -             | -             |
| 0016   | AMMUNITION, SMOKE with or without burster, expelling charge or propelling charge              | 1.3G              | See SP204            | -              | 204                | 0  | E0                  | P130 LP101           | PP67 L1      | -             | -             |
| 0018   | AMMUNITION, TEAR-PRODUCING with burster, expelling charge or propelling charge                | 1.2G              | 6.1/8                | -              | -                  | 0  | E0                  | P130 LP101           | PP67 L1      | -             | -             |
| 0019   | AMMUNITION, TEAR-PRODUCING with burster, expelling charge or propelling charge                | 1.3G              | 6.1/8                | -              | -                  | 0  | E0                  | P130 LP101           | PP67 L1      | -             | -             |
| 0020   | AMMUNITION, TOXIC with burster, expelling charge or propelling charge                         | 1.2K              | 6.1                  | -              | 274                | 0  | E0                  | P101                 | -            | -             | -             |
| 0021   | AMMUNITION, TOXIC with burster, expelling charge or propelling charge                         | 1.3K              | 6.1                  | -              | 274                | 0  | E0                  | P101                 | -            | -             | -             |
| 0027   | BLACK POWDER (GUNPOWDER) granular, or as a meal   | 1.1D              | -                    | -              | -                  | 0  | E0                  | P113                 | PP50         | -             | -             |
| 0028   | BLACK POWDER (GUNPOWDER), COMPRESSED or BLACK POWDER (GUNPOWDER), IN PELLETS                  | 1.1D              | -                    | -              | -                  | 0  | E0                  | P113                 | PP51         | -             | -             |
| 0029   | DETONATORS, NON-ELECTRIC for blasting   | 1.1B              | -                    | -              | -                  | 0  | E0                  | P131                 | PP68         | -             | -             |
| 0030   | DETONATORS, ELECTRIC for blasting   | 1.1B              | -                    | -              | 399                | 0  | E0                  | P131                 | -            | -             | -             |
| 0033   | BOMBS with bursting charge  | 1.1F              | -                    | -              | -                  | 0  | E0                  | P130 LP101           | -            | -             | -             |

| UN No. | Portable tanks and bulk containers |               | EmS                    | Stowage and handling    | Segregation      | Properties and observations          | UN No. |
|--------|------------------------------------|---------------|------------------------|-------------------------|------------------|--------------------------------------|--------|
|        | Tank instructions                  | Provisions    |                        |                         |                  |                                      |        |
| (12)   | (13)<br>4.2.5<br>4.3               | (14)<br>4.2.5 | (15)<br>5.4.3.4<br>7.8 | (16a)<br>7.1<br>7.3-7.7 | (16b)<br>7.2-7.7 | (17)                                 | (18)   |
| -      | -                                  | -             | F-B, S-Y               | Category 04 SW1         | SGG2 SG27 SG31   | Substance.                           | 0004   |
| -      | -                                  | -             | F-B, S-X               | Category 03 SW1         | -                | See glossary of terms in appendix B. | 0005   |
| -      | -                                  | -             | F-B, S-X               | Category 03 SW1         | -                | See glossary of terms in appendix B. | 0006   |
| -      | -                                  | -             | F-B, S-X               | Category 03 SW1         | -                | See glossary of terms in appendix B. | 0007   |
| -      | -                                  | -             | F-B, S-X               | Category 03 SW1         | -                | See glossary of terms in appendix B. | 0009   |
| -      | -                                  | -             | F-B, S-X               | Category 03 SW1         | -                | See glossary of terms in appendix B. | 0010   |
| -      | -                                  | -             | F-B, S-X               | Category 01 SW1         | -                | See glossary of terms in appendix B. | 0012   |
| -      | -                                  | -             | F-B, S-X               | Category 01 SW1         | -                | See glossary of terms in appendix B. | 0014   |
| -      | -                                  | -             | F-B, S-X               | Category 03 SW1         | -                | See glossary of terms in appendix B. | 0015   |
| -      | -                                  | -             | F-B, S-X               | Category 03 SW1         | -                | See glossary of terms in appendix B. | 0016   |
| -      | -                                  | -             | F-B, S-Z               | Category 03 SW1         | SG2              | See glossary of terms in appendix B. | 0018   |
| -      | -                                  | -             | F-B, S-Z               | Category 03 SW1         | SG3              | See glossary of terms in appendix B. | 0019   |
| -      | -                                  | -             | F-B, S-Z               | Category 05 SW1         | -                | See glossary of terms in appendix B. | 0020   |
| -      | -                                  | -             | F-B, S-Z               | Category 05 SW1         | -                | See glossary of terms in appendix B. | 0021   |
| -      | -                                  | -             | F-B, S-Y               | Category 04 SW1         | -                | See glossary of terms in appendix B. | 0027   |
| -      | -                                  | -             | F-B, S-Y               | Category 04 SW1         | -                | See glossary of terms in appendix B. | 0028   |
| -      | -                                  | -             | F-B, S-X               | Category 05 SW1         | -                | See glossary of terms in appendix B. | 0029   |
| -      | -                                  | -             | F-B, S-X               | Category 05 SW1         | -                | See glossary of terms in appendix B. | 0030   |
| -      | -                                  | -             | F-B, S-X               | Category 03 SW1         | -                | See glossary of terms in appendix B. | 0033   |

Part 3 – Dangerous Goods List, special provisions and exceptions

Chapter 3.2 – Dangerous Goods List

| UN No. | Proper shipping name (PSN)  | Class or division | Subsidiary hazard(s) | Packing group  | Special provisions | Limited and excepted quantity provisions |                     | Packing         |                     | IBC           |               |
|--------|---|-------------------|----------------------|----------------|--------------------|--|---------------------|-----------------|---------------------|---------------|---------------|
|        |   |                   |                      |                |                    | Limited quantities                       | Excepted quantities | Instructions    | Provisions          | Instructions  | Provisions    |
| (1)    | (2)<br>3.1.2  | (3)<br>2.0        | (4)<br>2.0           | (5)<br>2.0.1.3 | (6)<br>3.3         | (7a)<br>3.4                              | (7b)<br>3.5         | (8)<br>4.1.4    | (9)<br>4.1.4        | (10)<br>4.1.4 | (11)<br>4.1.4 |
| 0034   | BOMBS with bursting charge  | 1.1D              | –                    | –              | –                  | 0  | E0                  | P130 LP101      | PP67 L1             | –             | –             |
| 0035   | BOMBS with bursting charge  | 1.2D              | –                    | –              | –                  | 0  | E0                  | P130 LP101      | PP67 L1             | –             | –             |
| 0037   | BOMBS, PHOTO-FLASH  | 1.1F              | –                    | –              | –                  | 0  | E0                  | P130 LP101      | –                   | –             | –             |
| 0038   | BOMBS, PHOTO-FLASH  | 1.1D              | –                    | –              | –                  | 0  | E0                  | P130 LP101      | PP67 L1             | –             | –             |
| 0039   | BOMBS, PHOTO-FLASH  | 1.2G              | –                    | –              | –                  | 0  | E0                  | P130 LP101      | PP67 L1             | –             | –             |
| 0042   | BOOSTERS without detonator  | 1.1D              | –                    | –              | –                  | 0  | E0                  | P132 (a) or (b) | –                   | –             | –             |
| 0043   | BURSTERS explosive  | 1.1D              | –                    | –              | –                  | 0  | E0                  | P133            | PP69                | –             | –             |
| 0044   | PRIMERS, CAP TYPE   | 1.4S              | –                    | –              | –                  | 0  | E0                  | P133            | –                   | –             | –             |
| 0048   | CHARGES, DEMOLITION   | 1.1D              | –                    | –              | –                  | 0  | E0                  | P130 LP101      | PP67 L1             | –             | –             |
| 0049   | CARTRIDGES, FLASH   | 1.1G              | –                    | –              | –                  | 0  | E0                  | P135            | –                   | –             | –             |
| 0050   | CARTRIDGES, FLASH   | 1.3G              | –                    | –              | –                  | 0  | E0                  | P135            | –                   | –             | –             |
| 0054   | CARTRIDGES, SIGNAL  | 1.3G              | –                    | –              | –                  | 0  | E0                  | P135            | –                   | –             | –             |
| 0055   | CASES, CARTRIDGE, EMPTY, WITH PRIMER  | 1.4S              | –                    | –              | 364                | 5 kg                                     | E0                  | P136            | –                   | –             | –             |
| 0056   | CHARGES, DEPTH  | 1.1D              | –                    | –              | –                  | 0  | E0                  | P130 LP101      | PP67 L1             | –             | –             |
| 0059   | CHARGES, SHAPED, without detonator  | 1.1D              | –                    | –              | –                  | 0  | E0                  | P137            | PP70                | –             | –             |
| 0060   | CHARGES, SUPPLEMENTARY, EXPLOSIVE   | 1.1D              | –                    | –              | –                  | 0  | E0                  | P132 (a) or (b) | –                   | –             | –             |
| 0065   | CORD, DETONATING, flexible  | 1.1D              | –                    | –              | –                  | 0  | E0                  | P139            | PP71 PP72           | –             | –             |
| 0066   | CORD, IGNITER   | 1.4G              | –                    | –              | –                  | 0  | E0                  | P140            | –                   | –             | –             |
| 0070   | CUTTERS, CABLE, EXPLOSIVE   | 1.4S              | –                    | –              | –                  | 0  | E0                  | P134 LP102      | –                   | –             | –             |
| 0072   | CYCLOTRIMETHYLENE-TRINITRAMINE (CYCLONITE; HEXOGEN; RDX), WETTED with not less than 15% water, by mass              | 1.1D              | –                    | –              | 266                | 0  | E0                  | P112 (a)        | PP45                | –             | –             |
| 0073   | DETONATORS FOR AMMUNITION   | 1.1B              | –                    | –              | –                  | 0  | E0                  | P133            | –                   | –             | –             |
| 0074   | DIAZODINITROPHENOL, WETTED with not less than 40% water, or mixture of alcohol and water, by mass                   | 1.1A              | –                    | –              | 266                | 0  | E0                  | P110 (a) or (b) | PP42                | –             | –             |
| 0075   | DIETHYLENEGLYCOL DINITRATE, DESENSITIZED with not less than 25% non-volatile, water-insoluble phlegmatizer, by mass | 1.1D              | –                    | –              | 266                | 0  | E0                  | P115            | PP53 PP54 PP57 PP58 | –             | –             |

| UN No. | Portable tanks and bulk containers |               | EmS                    | Stowage and handling    | Segregation      | Properties and observations  | UN No. |
|--------|------------------------------------|---------------|------------------------|-------------------------|------------------|--|--------|
|        | Tank instructions                  | Provisions    |                        |                         |                  |  |        |
| (12)   | (13)<br>4.2.5<br>4.3               | (14)<br>4.2.5 | (15)<br>5.4.3.4<br>7.8 | (16a)<br>7.1<br>7.3–7.7 | (16b)<br>7.2–7.7 | (17)   | (18)   |
| –      | –                                  | –             | F-B, S-X               | Category 03 SW1         | –                | See glossary of terms in appendix B.   | 0034   |
| –      | –                                  | –             | F-B, S-X               | Category 03 SW1         | –                | See glossary of terms in appendix B.   | 0035   |
| –      | –                                  | –             | F-B, S-X               | Category 03 SW1         | –                | See glossary of terms in appendix B.   | 0037   |
| –      | –                                  | –             | F-B, S-X               | Category 03 SW1         | –                | See glossary of terms in appendix B.   | 0038   |
| –      | –                                  | –             | F-B, S-X               | Category 03 SW1         | –                | See glossary of terms in appendix B.   | 0039   |
| –      | –                                  | –             | F-B, S-X               | Category 03 SW1         | –                | See glossary of terms in appendix B.   | 0042   |
| –      | –                                  | –             | F-B, S-X               | Category 03 SW1         | –                | See glossary of terms in appendix B.   | 0043   |
| –      | –                                  | –             | F-B, S-X               | Category 01 SW1         | –                | See glossary of terms in appendix B.   | 0044   |
| –      | –                                  | –             | F-B, S-X               | Category 03 SW1         | –                | See glossary of terms in appendix B.   | 0048   |
| –      | –                                  | –             | F-B, S-X               | Category 03 SW1         | –                | See glossary of terms in appendix B.   | 0049   |
| –      | –                                  | –             | F-B, S-X               | Category 03 SW1         | –                | See glossary of terms in appendix B.   | 0050   |
| –      | –                                  | –             | F-B, S-X               | Category 03 SW1         | –                | See glossary of terms in appendix B.   | 0054   |
| –      | –                                  | –             | F-B, S-X               | Category 01 SW1         | –                | See glossary of terms in appendix B.   | 0055   |
| –      | –                                  | –             | F-B, S-X               | Category 03 SW1         | –                | See glossary of terms in appendix B.   | 0056   |
| –      | –                                  | –             | F-B, S-X               | Category 03 SW1         | –                | See glossary of terms in appendix B.   | 0059   |
| –      | –                                  | –             | F-B, S-X               | Category 03 SW1         | –                | See glossary of terms in appendix B.   | 0060   |
| –      | –                                  | –             | F-B, S-X               | Category 03 SW1         | –                | See glossary of terms in appendix B.   | 0065   |
| –      | –                                  | –             | F-B, S-X               | Category 02 SW1         | –                | See glossary of terms in appendix B.   | 0066   |
| –      | –                                  | –             | F-B, S-X               | Category 01 SW1         | –                | See glossary of terms in appendix B.   | 0070   |
| –      | –                                  | –             | F-B, S-Y               | Category 04 SW1         | –                | Mass detonating explosive which becomes more sensitive if the wetting agent is lost. This substance, when containing less alcohol, water or phlegmatizer than specified, shall not be transported, unless specifically authorized by the competent authority.                      | 0072   |
| –      | –                                  | –             | F-B, S-X               | Category 05 SW1         | –                | See glossary of terms in appendix B.   | 0073   |
| –      | –                                  | –             | F-B, S-Y               | Category 05 SW1         | –                | Sensitive substance used in detonators, which becomes extremely sensitive if the wetting agents are lost. This substance, when containing less alcohol, water or phlegmatizer than specified, shall not be transported, unless specifically authorized by the competent authority. | 0074   |
| –      | –                                  | –             | F-B, S-Y               | Category 04 SW1         | –                | This substance, when containing less alcohol, water or phlegmatizer than specified, shall not be transported, unless specifically authorized by the competent authority.   | 0075   |



Part 3 – Dangerous Goods List, special provisions and exceptions

Chapter 3.2 – Dangerous Goods List

| UN No. | Proper shipping name (PSN)  | Class or division | Subsidiary hazard(s) | Packing group  | Special provisions | Limited and excepted quantity provisions |                     | Packing              |              | IBC           |               |
|--------|---|-------------------|----------------------|----------------|--------------------|--|---------------------|----------------------|--------------|---------------|---------------|
|        |   |                   |                      |                |                    | Limited quantities                       | Excepted quantities | Instructions         | Provisions   | Instructions  | Provisions    |
| (1)    | (2)<br>3.1.2  | (3)<br>2.0        | (4)<br>2.0           | (5)<br>2.0.1.3 | (6)<br>3.3         | (7a)<br>3.4                              | (7b)<br>3.5         | (8)<br>4.1.4         | (9)<br>4.1.4 | (10)<br>4.1.4 | (11)<br>4.1.4 |
| 0076   | DINITROPHENOL, dry or wetted with less than 15% water, by mass  | 1.1D              | 6.1<br>P             | -              | -                  | 0  | E0                  | P112 (a), (b) or (c) | PP26         | -             | -             |
| 0077   | DINITROPHENOLATES, alkali metals, dry or wetted with less than 15% water, by mass   | 1.3C              | 6.1<br>P             | -              | -                  | 0  | E0                  | P114 (a) or (b)      | PP26         | -             | -             |
| 0078   | DINITRORESORCINOL, dry or wetted with less than 15% water, by mass  | 1.1D              | -                    | -              | -                  | 0  | E0                  | P112 (a), (b) or (c) | PP26         | -             | -             |
| 0079   | HEXANITRODIPHENYLAMINE (DIPICRYLAMINE; HEXYL)   | 1.1D              | -                    | -              | -                  | 0  | E0                  | P112 (b) or (c)      | -            | -             | -             |
| 0081   | EXPLOSIVE, BLASTING, TYPE A   | 1.1D              | -                    | -              | -                  | 0  | E0                  | P116                 | PP63<br>PP66 | -             | -             |
| 0082   | EXPLOSIVE, BLASTING, TYPE B   | 1.1D              | -                    | -              | -                  | 0  | E0                  | P116                 | PP61<br>PP62 | IBC100        | B9            |
| 0083   | EXPLOSIVE, BLASTING, TYPE C   | 1.1D              | -                    | -              | 267                | 0  | E0                  | P116                 | -            | -             | -             |
| 0084   | EXPLOSIVE, BLASTING, TYPE D   | 1.1D              | -                    | -              | -                  | 0  | E0                  | P116                 | -            | -             | -             |
| 0092   | FLARES, SURFACE   | 1.3G              | -                    | -              | -                  | 0  | E0                  | P135                 | -            | -             | -             |
| 0093   | FLARES, AERIAL  | 1.3G              | -                    | -              | -                  | 0  | E0                  | P135                 | -            | -             | -             |
| 0094   | FLASH POWDER  | 1.1G              | -                    | -              | -                  | 0  | E0                  | P113                 | PP49         | -             | -             |
| 0099   | FRACTURING DEVICES, EXPLOSIVE without detonator, for oil wells  | 1.1D              | -                    | -              | -                  | 0  | E0                  | P134<br>LP102        | -            | -             | -             |
| 0101   | FUSE, NON-DETONATING  | 1.3G              | -                    | -              | -                  | 0  | E0                  | P140                 | PP74<br>PP75 | -             | -             |
| 0102   | CORD (FUSE), DETONATING, metal-clad   | 1.2D              | -                    | -              | -                  | 0  | E0                  | P139                 | PP71         | -             | -             |
| 0103   | FUSE, IGNITER tubular, metal-clad   | 1.4G              | -                    | -              | -                  | 0  | E0                  | P140                 | -            | -             | -             |
| 0104   | CORD (FUSE), DETONATING, MILD EFFECT, metal-clad  | 1.4D              | -                    | -              | -                  | 0  | E0                  | P139                 | PP71         | -             | -             |
| 0105   | FUSE, SAFETY  | 1.4S              | -                    | -              | -                  | 0  | E0                  | P140                 | PP73         | -             | -             |
| 0106   | FUZES, DETONATING   | 1.1B              | -                    | -              | -                  | 0  | E0                  | P141                 | -            | -             | -             |
| 0107   | FUZES, DETONATING   | 1.2B              | -                    | -              | -                  | 0  | E0                  | P141                 | -            | -             | -             |
| 0110   | GRENADES, PRACTICE, hand or rifle   | 1.4S              | -                    | -              | -                  | 0  | E0                  | P141                 | -            | -             | -             |
| 0113   | GUANYL NITROSAMINO-GUANYLIDENE HYDRAZINE, WETTED with not less than 30% water, by mass  | 1.1A              | -                    | -              | 266                | 0  | E0                  | P110 (a) or (b)      | PP42         | -             | -             |
| 0114   | GUANYL NITROSAMINO-GUANYLTETRAZENE (TETRAZENE), WETTED with not less than 30% water, or mixture of alcohol and water, by mass | 1.1A              | -                    | -              | 266                | 0  | E0                  | P110 (a) or (b)      | PP42         | -             | -             |

| UN No. | Portable tanks and bulk containers |               | EmS                    | Stowage and handling    | Segregation      | Properties and observations  | UN No. |
|--------|------------------------------------|---------------|------------------------|-------------------------|------------------|--|--------|
|        | Tank instructions                  | Provisions    |                        |                         |                  |  |        |
| (12)   | (13)<br>4.2.5<br>4.3               | (14)<br>4.2.5 | (15)<br>5.4.3.4<br>7.8 | (16a)<br>7.1<br>7.3-7.7 | (16b)<br>7.2-7.7 | (17)   | (18)   |
| -      | -                                  | -             | F-B, S-Z               | Category 04 SW1         | SG31             | Substance.   | 0076   |
| -      | -                                  | -             | F-B, S-Z               | Category 04 SW1         | SG31             | Substance.   | 0077   |
| -      | -                                  | -             | F-B, S-Y               | Category 04 SW1         | SG31             | Substance.   | 0078   |
| -      | -                                  | -             | F-B, S-Y               | Category 04 SW1         | -                | Substance.   | 0079   |
| -      | -                                  | -             | F-B, S-Y               | Category 04 SW1         | SG34             | Substance. See glossary of terms in appendix B.  | 0081   |
| -      | -                                  | -             | F-B, S-Y               | Category 04 SW1         | SG34             | Substance. See glossary of terms in appendix B.  | 0082   |
| -      | -                                  | -             | F-B, S-Y               | Category 04 SW1         | SG28             | Substance. See glossary of terms in appendix B.  | 0083   |
| -      | -                                  | -             | F-B, S-Y               | Category 04 SW1         | -                | Substance. See glossary of terms in appendix B.  | 0084   |
| -      | -                                  | -             | F-B, S-X               | Category 03 SW1         | -                | See glossary of terms in appendix B.   | 0092   |
| -      | -                                  | -             | F-B, S-X               | Category 03 SW1         | -                | See glossary of terms in appendix B.   | 0093   |
| -      | -                                  | -             | F-B, S-Y               | Category 03 SW1         | -                | See glossary of terms in appendix B.   | 0094   |
| -      | -                                  | -             | F-B, S-X               | Category 03 SW1         | -                | See glossary of terms in appendix B.   | 0099   |
| -      | -                                  | -             | F-B, S-X               | Category 03 SW1         | -                | See glossary of terms in appendix B.   | 0101   |
| -      | -                                  | -             | F-B, S-X               | Category 03 SW1         | -                | See glossary of terms in appendix B.   | 0102   |
| -      | -                                  | -             | F-B, S-X               | Category 02 SW1         | -                | See glossary of terms in appendix B.   | 0103   |
| -      | -                                  | -             | F-B, S-X               | Category 02 SW1         | -                | See glossary of terms in appendix B.   | 0104   |
| -      | -                                  | -             | F-B, S-X               | Category 01 SW1         | -                | See glossary of terms in appendix B.   | 0105   |
| -      | -                                  | -             | F-B, S-X               | Category 05 SW1         | -                | See glossary of terms in appendix B.   | 0106   |
| -      | -                                  | -             | F-B, S-X               | Category 05 SW1         | -                | See glossary of terms in appendix B.   | 0107   |
| -      | -                                  | -             | F-B, S-X               | Category 01 SW1         | -                | See glossary of terms in appendix B.   | 0110   |
| -      | -                                  | -             | F-B, S-Y               | Category 05 SW1         | -                | Sensitive substance used in detonators, which becomes extremely sensitive if the wetting agents are lost. This substance, when containing less alcohol, water or phlegmatizer than specified, shall not be transported, unless specifically authorized by the competent authority. | 0113   |
| -      | -                                  | -             | F-B, S-Y               | Category 05 SW1         | -                | Sensitive substance used in detonators, which becomes extremely sensitive if the wetting agents are lost. This substance, when containing less alcohol, water or phlegmatizer than specified, shall not be transported, unless specifically authorized by the competent authority. | 0114   |

Part 3 – Dangerous Goods List, special provisions and exceptions

Chapter 3.2 – Dangerous Goods List

| UN No. | Proper shipping name (PSN)   | Class or division | Subsidiary hazard(s) | Packing group  | Special provisions | Limited and excepted quantity provisions |                     | Packing              |                          | IBC           |               |
|--------|--|-------------------|----------------------|----------------|--------------------|--|---------------------|----------------------|--------------------------|---------------|---------------|
|        |  |                   |                      |                |                    | Limited quantities                       | Excepted quantities | Instructions         | Provisions               | Instructions  | Provisions    |
| (1)    | (2)<br>3.1.2   | (3)<br>2.0        | (4)<br>2.0           | (5)<br>2.0.1.3 | (6)<br>3.3         | (7a)<br>3.4                              | (7b)<br>3.5         | (8)<br>4.1.4         | (9)<br>4.1.4             | (10)<br>4.1.4 | (11)<br>4.1.4 |
| 0118   | HEXOLITE (HEXOTOL), dry or wetted with less than 15% water, by mass  | 1.1D              | -                    | -              | -                  | 0  | E0                  | P112 (a), (b) or (c) | -                        | -             | -             |
| 0121   | IGNITERS   | 1.1G              | -                    | -              | -                  | 0  | E0                  | P142                 | -                        | -             | -             |
| 0124   | JET PERFORATING GUNS, CHARGED, oil well, without detonator   | 1.1D              | -                    | -              | -                  | 0  | E0                  | P101                 | -                        | -             | -             |
| 0129   | LEAD AZIDE, WETTED with not less than 20% water, or mixture of alcohol and water, by mass                                | 1.1A              | -                    | -              | 266                | 0  | E0                  | P110 (a) or (b)      | PP42                     | -             | -             |
| 0130   | LEAD STYPHNATE (LEAD TRINITRORESORCINATE), WETTED with not less than 20% water, or mixture of alcohol and water, by mass | 1.1A              | -                    | -              | 266                | 0  | E0                  | P110 (a) or (b)      | PP42                     | -             | -             |
| 0131   | LIGHTERS, FUSE   | 1.4S              | -                    | -              | -                  | 0  | E0                  | P142                 | -                        | -             | -             |
| 0132   | DEFLAGRATING METAL SALTS OF AROMATIC NITRO-DERIVATIVES, N.O.S.   | 1.3C              | -                    | -              | -                  | 0  | E0                  | P114 (b)             | PP26                     | -             | -             |
| 0133   | MANNITOL HEXANITRATE (NITROMANNITE), WETTED with not less than 40% water, or mixture of alcohol and water, by mass       | 1.1D              | -                    | -              | 266                | 0  | E0                  | P112 (a)             | -                        | -             | -             |
| 0135   | MERCURY FULMINATE, WETTED with not less than 20% water, or mixture of alcohol and water, by mass                         | 1.1A              | -                    | -              | 266                | 0  | E0                  | P110 (a) or (b)      | PP42                     | -             | -             |
| 0136   | MINES with bursting charge   | 1.1F              | -                    | -              | -                  | 0  | E0                  | P130 LP101           | -                        | -             | -             |
| 0137   | MINES with bursting charge   | 1.1D              | -                    | -              | -                  | 0  | E0                  | P130 LP101           | PP67 L1                  | -             | -             |
| 0138   | MINES with bursting charge   | 1.2D              | -                    | -              | -                  | 0  | E0                  | P130 LP101           | PP67 L1                  | -             | -             |
| 0143   | NITROGLYCERIN, DESENSITIZED with not less than 40% non-volatile water-insoluble phlegmatizer, by mass                    | 1.1D              | See SP271            | -              | 266 271 272        | 0  | E0                  | P115                 | PP53 PP54 PP57 PP58      | -             | -             |
| 0144   | NITROGLYCERIN SOLUTION IN ALCOHOL with more than 1% but not more than 10% nitroglycerin                                  | 1.1D              | -                    | -              | 358                | 0  | E0                  | P115                 | PP45 PP55 PP56 PP59 PP60 | -             | -             |
| 0146   | NITROSTARCH, dry or wetted, with less than 20% water, by mass  | 1.1D              | -                    | -              | -                  | 0  | E0                  | P112 (a), (b) or (c) | -                        | -             | -             |
| 0147   | NITRO UREA   | 1.1D              | -                    | -              | -                  | 0  | E0                  | P112 (b)             | -                        | -             | -             |

| UN No. | Portable tanks and bulk containers |               | EmS                    | Stowage and handling    | Segregation      | Properties and observations   | UN No. |
|--------|------------------------------------|---------------|------------------------|-------------------------|------------------|---|--------|
|        | Tank instructions                  | Provisions    |                        |                         |                  |   |        |
| (12)   | (13)<br>4.2.5<br>4.3               | (14)<br>4.2.5 | (15)<br>5.4.3.4<br>7.8 | (16a)<br>7.1<br>7.3-7.7 | (16b)<br>7.2-7.7 | (17)  | (18)   |
| -      | -                                  | -             | F-B, S-Y               | Category 04 SW1         | -                | Substance. Mixtures of mass detonating explosives.  | 0118   |
| -      | -                                  | -             | F-B, S-X               | Category 03 SW1         | -                | See glossary of terms in appendix B.  | 0121   |
| -      | -                                  | -             | F-B, S-X               | Category 03 SW1 SW30    | -                | See glossary of terms in appendix B.  | 0124   |
| -      | -                                  | -             | F-B, S-Y               | Category 05 SW1         | SGG7 SGG9 SGG17  | Sensitive substance used in detonators, which becomes extremely sensitive if the wetting agents are lost. This substance, when containing less alcohol, water or phlegmatizer than specified, shall not be transported, unless specifically authorized by the competent authority.                    | 0129   |
| -      | -                                  | -             | F-B, S-Y               | Category 05 SW1         | SGG7 SGG9        | Sensitive substance used in detonators, which becomes extremely sensitive if the wetting agents are lost. This substance, when containing less alcohol, water or phlegmatizer than specified, shall not be transported, unless specifically authorized by the competent authority.                    | 0130   |
| -      | -                                  | -             | F-B, S-X               | Category 01 SW1         | -                | See glossary of terms in appendix B.  | 0131   |
| -      | -                                  | -             | F-B, S-Y               | Category 04 SW1         | SG31             | Substance.  | 0132   |
| -      | -                                  | -             | F-B, S-Y               | Category 04 SW1         | -                | This substance, when containing less alcohol, water or phlegmatizer than specified, shall not be transported, unless specifically authorized by the competent authority.  | 0133   |
| -      | -                                  | -             | F-B, S-Y               | Category 05 SW1         | SGG7 SGG11       | Sensitive substance used in detonators which will become extremely sensitive if it loses its wetting or desensitizing agent. This substance, when containing less alcohol, water or phlegmatizer than specified, shall not be transported, unless specifically authorized by the competent authority. | 0135   |
| -      | -                                  | -             | F-B, S-X               | Category 03 SW1         | -                | See glossary of terms in appendix B.  | 0136   |
| -      | -                                  | -             | F-B, S-X               | Category 03 SW1         | -                | See glossary of terms in appendix B.  | 0137   |
| -      | -                                  | -             | F-B, S-X               | Category 03 SW1         | -                | See glossary of terms in appendix B.  | 0138   |
| -      | -                                  | -             | F-B, S-Z               | Category 04 SW1         | -                | Substance. This substance, when containing less alcohol, water or phlegmatizer than specified, shall not be transported, unless specifically authorized by the competent authority.   | 0143   |
| -      | -                                  | -             | F-B, S-Y               | Category 04 SW1         | -                | Substance.  | 0144   |
| -      | -                                  | -             | F-B, S-Y               | Category 04 SW1         | -                | Substance.  | 0146   |
| -      | -                                  | -             | F-B, S-Y               | Category 04 SW1         | -                | Substance.  | 0147   |

Part 3 – Dangerous Goods List, special provisions and exceptions

Chapter 3.2 – Dangerous Goods List

| UN No. | Proper shipping name (PSN)  | Class or division | Subsidiary hazard(s) | Packing group  | Special provisions | Limited and excepted quantity provisions |                     | Packing              |              | IBC           |               |
|--------|---|-------------------|----------------------|----------------|--------------------|--|---------------------|----------------------|--------------|---------------|---------------|
|        |   |                   |                      |                |                    | Limited quantities                       | Excepted quantities | Instructions         | Provisions   | Instructions  | Provisions    |
| (1)    | (2)<br>3.1.2  | (3)<br>2.0        | (4)<br>2.0           | (5)<br>2.0.1.3 | (6)<br>3.3         | (7a)<br>3.4                              | (7b)<br>3.5         | (8)<br>4.1.4         | (9)<br>4.1.4 | (10)<br>4.1.4 | (11)<br>4.1.4 |
| 0150   | PENTAERYTHRITE TETRANITRATE (PENTAERYTHRITOL TETRANITRATE; PETN), WETTED with not less than 25% water, by mass or PENTAERYTHRITE TETRANITRATE (PENTAERYTHRITOL TETRANITRATE; PETN), DESENSITIZED with not less than 15% phlegmatizer, by mass | 1.1D              | -                    | -              | 266                | 0  | E0                  | P112 (a) or (b)      | -            | -             | -             |
| 0151   | PENTOLITE, dry or wetted with less than 15% water, by mass  | 1.1D              | -                    | -              | -                  | 0  | E0                  | P112 (a), (b) or (c) | -            | -             | -             |
| 0153   | TRINITROANILINE (PICRAMIDE)   | 1.1D              | -                    | -              | -                  | 0  | E0                  | P112 (b) or (c)      | -            | -             | -             |
| 0154   | TRINITROPHENOL (PICRIC ACID), dry or wetted with less than 30% water, by mass   | 1.1D              | -                    | -              | -                  | 0  | E0                  | P112 (a), (b) or (c) | PP26         | -             | -             |
| 0155   | TRINITROCHLORO BENZENE (PICRYL CHLORIDE)  | 1.1D              | -                    | -              | -                  | 0  | E0                  | P112 (b) or (c)      | -            | -             | -             |
| 0159   | POWDER CAKE (POWDER PASTE), WETTED with not less than 25% water, by mass  | 1.3C              | -                    | -              | 266                | 0  | E0                  | P111                 | PP43         | -             | -             |
| 0160   | POWDER, SMOKELESS   | 1.1C              | -                    | -              | -                  | 0  | E0                  | P114 (b)             | PP50<br>PP52 | -             | -             |
| 0161   | POWDER, SMOKELESS   | 1.3C              | -                    | -              | -                  | 0  | E0                  | P114 (b)             | PP50<br>PP52 | -             | -             |
| 0167   | PROJECTILES with bursting charge  | 1.1F              | -                    | -              | -                  | 0  | E0                  | P130<br>LP101        | -            | -             | -             |
| 0168   | PROJECTILES with bursting charge  | 1.1D              | -                    | -              | -                  | 0  | E0                  | P130<br>LP101        | PP67<br>L1   | -             | -             |
| 0169   | PROJECTILES with bursting charge  | 1.2D              | -                    | -              | -                  | 0  | E0                  | P130<br>LP101        | PP67<br>L1   | -             | -             |
| 0171   | AMMUNITION, ILLUMINATING with or without burster, expelling charge or propelling charge   | 1.2G              | -                    | -              | -                  | 0  | E0                  | P130<br>LP101        | PP67<br>L1   | -             | -             |
| 0173   | RELEASE DEVICES, EXPLOSIVE  | 1.4S              | -                    | -              | -                  | 0  | E0                  | P134<br>LP102        | -            | -             | -             |
| 0174   | RIVETS, EXPLOSIVE   | 1.4S              | -                    | -              | -                  | 0  | E0                  | P134<br>LP102        | -            | -             | -             |
| 0180   | ROCKETS with bursting charge  | 1.1F              | -                    | -              | -                  | 0  | E0                  | P130<br>LP101        | -            | -             | -             |
| 0181   | ROCKETS with bursting charge  | 1.1E              | -                    | -              | -                  | 0  | E0                  | P130<br>LP101        | PP67<br>L1   | -             | -             |
| 0182   | ROCKETS with bursting charge  | 1.2E              | -                    | -              | -                  | 0  | E0                  | P130<br>LP101        | PP67<br>L1   | -             | -             |
| 0183   | ROCKETS with inert head   | 1.3C              | -                    | -              | -                  | 0  | E0                  | P130<br>LP101        | PP67<br>L1   | -             | -             |
| 0186   | ROCKET MOTORS   | 1.3C              | -                    | -              | -                  | 0  | E0                  | P130<br>LP101        | PP67<br>L1   | -             | -             |
| 0190   | SAMPLES, EXPLOSIVE, other than initiating explosive   | 1                 | -                    | -              | 16<br>274          | 0  | E0                  | P101                 | -            | -             | -             |

| UN No. | Portable tanks and bulk containers |               | EmS                    | Stowage and handling    | Segregation      | Properties and observations   | UN No. |
|--------|------------------------------------|---------------|------------------------|-------------------------|------------------|---|--------|
|        | Tank instructions                  | Provisions    |                        |                         |                  |   |        |
| (12)   | (13)<br>4.2.5<br>4.3               | (14)<br>4.2.5 | (15)<br>5.4.3.4<br>7.8 | (16a)<br>7.1<br>7.3-7.7 | (16b)<br>7.2-7.7 | (17)  | (18)   |
| -      | -                                  | -             | F-B, S-Y               | Category 04<br>SW1      | -                | Substance. Mass detonating explosive which will become more sensitive if it loses its wetting or desensitizing agent. This substance, when containing less alcohol, water or phlegmatizer than specified, shall not be transported, unless specifically authorized by the competent authority.                              | 0150   |
| -      | -                                  | -             | F-B, S-Y               | Category 04<br>SW1      | -                | Substance. Mixtures of mass detonating explosive substances.  | 0151   |
| -      | -                                  | -             | F-B, S-Y               | Category 04<br>SW1      | -                | Substance.  | 0153   |
| -      | -                                  | -             | F-B, S-Y               | Category 04<br>SW1      | SG31             | Substance.  | 0154   |
| -      | -                                  | -             | F-B, S-Y               | Category 04<br>SW1      | -                | Substance.  | 0155   |
| -      | -                                  | -             | F-B, S-Y               | Category 04<br>SW1      | -                | Substance consisting of nitrocellulose impregnated with not more than 60% of nitroglycerin or other liquid organic nitrates or a mixture of these. This substance, when containing less alcohol, water or phlegmatizer than specified, shall not be transported, unless specifically authorized by the competent authority. | 0159   |
| -      | -                                  | -             | F-B, S-Y               | Category 04<br>SW1      | -                | Substances based on nitrocellulose used as propellant. Sensitive to sparks, friction, pressure and electrostatic discharge.   | 0160   |
| -      | -                                  | -             | F-B, S-Y               | Category 04<br>SW1      | -                | Substances based on nitrocellulose used as propellant. Sensitive to sparks, friction, pressure and electrostatic discharge.   | 0161   |
| -      | -                                  | -             | F-B, S-X               | Category 03<br>SW1      | -                | See glossary of terms in appendix B.  | 0167   |
| -      | -                                  | -             | F-B, S-X               | Category 03<br>SW1      | -                | See glossary of terms in appendix B.  | 0168   |
| -      | -                                  | -             | F-B, S-X               | Category 03<br>SW1      | -                | See glossary of terms in appendix B.  | 0169   |
| -      | -                                  | -             | F-B, S-X               | Category 03<br>SW1      | -                | See glossary of terms in appendix B.  | 0171   |
| -      | -                                  | -             | F-B, S-X               | Category 01<br>SW1      | -                | See glossary of terms in appendix B.  | 0173   |
| -      | -                                  | -             | F-B, S-X               | Category 01<br>SW1      | -                | See glossary of terms in appendix B.  | 0174   |
| -      | -                                  | -             | F-B, S-X               | Category 03<br>SW1      | -                | See glossary of terms in appendix B.  | 0180   |
| -      | -                                  | -             | F-B, S-X               | Category 03<br>SW1      | -                | See glossary of terms in appendix B.  | 0181   |
| -      | -                                  | -             | F-B, S-X               | Category 03<br>SW1      | -                | See glossary of terms in appendix B.  | 0182   |
| -      | -                                  | -             | F-B, S-X               | Category 03<br>SW1      | -                | See glossary of terms in appendix B.  | 0183   |
| -      | -                                  | -             | F-B, S-X               | Category 03<br>SW1      | -                | See glossary of terms in appendix B.  | 0186   |
| -      | -                                  | -             | F-B, S-X               | Category 05<br>SW1      | -                | Substance or article. Division and compatibility group as classified by the competent authority.  | 0190   |

Part 3 – Dangerous Goods List, special provisions and exceptions

Chapter 3.2 – Dangerous Goods List

| UN No. | Proper shipping name (PSN)   | Class or division | Subsidiary hazard(s) | Packing group  | Special provisions | Limited and excepted quantity provisions |                     | Packing              |              | IBC           |                 |
|--------|--|-------------------|----------------------|----------------|--------------------|--|---------------------|----------------------|--------------|---------------|-----------------|
|        |  |                   |                      |                |                    | Limited quantities                       | Excepted quantities | Instructions         | Provisions   | Instructions  | Provisions      |
| (1)    | (2)<br>3.1.2   | (3)<br>2.0        | (4)<br>2.0           | (5)<br>2.0.1.3 | (6)<br>3.3         | (7a)<br>3.4                              | (7b)<br>3.5         | (8)<br>4.1.4         | (9)<br>4.1.4 | (10)<br>4.1.4 | (11)<br>4.1.4   |
| 0191   | SIGNAL DEVICES, HAND   | 1.4G              | -                    | -              | -                  | 0  | E0                  | P135                 | -            | -             | -               |
| 0192   | SIGNALS, RAILWAY TRACK, EXPLOSIVE  | 1.1G              | -                    | -              | -                  | 0  | E0                  | P135                 | -            | -             | -               |
| 0193   | SIGNALS, RAILWAY TRACK, EXPLOSIVE  | 1.4S              | -                    | -              | -                  | 0  | E0                  | P135                 | -            | -             | -               |
| 0194   | SIGNALS, DISTRESS, ship  | 1.1G              | -                    | -              | -                  | 0  | E0                  | P135                 | -            | -             | -               |
| 0195   | SIGNALS, DISTRESS, ship  | 1.3G              | -                    | -              | -                  | 0  | E0                  | P135                 | -            | -             | -               |
| 0196   | SIGNALS, SMOKE   | 1.1G              | -                    | -              | -                  | 0  | E0                  | P135                 | -            | -             | -               |
| 0197   | SIGNALS, SMOKE   | 1.4G              | -                    | -              | -                  | 0  | E0                  | P135                 | -            | -             | -               |
| 0204   | SOUNDING DEVICES, EXPLOSIVE  | 1.2F              | -                    | -              | -                  | 0  | E0                  | P134 LP102           | -            | -             | -               |
| 0207   | TETRANITROANILINE  | 1.1D              | -                    | -              | -                  | 0  | E0                  | P112 (b) or (c)      | -            | -             | -               |
| 0208   | TRINITROPHENYLMETHYL-NITRAMINE (TETRYL)  | 1.1D              | -                    | -              | -                  | 0  | E0                  | P112 (b) or (c)      | -            | -             | -               |
| 0209   | TRINITROTOLUENE (TNT), dry or wetted with less than 30% water, by mass   | 1.1D              | -                    | -              | -                  | 0  | E0                  | P112 (a), (b) or (c) | PP46         | -             | -               |
| 0212   | TRACERS FOR AMMUNITION   | 1.3G              | -                    | -              | -                  | 0  | E0                  | P133                 | PP69         | -             | -               |
| 0213   | TRINITROANISOLE  | 1.1D              | -                    | -              | -                  | 0  | E0                  | P112 (b) or (c)      | -            | -             | -               |
| 0214   | TRINITROBENZENE, dry or wetted with less than 30% water, by mass   | 1.1D              | -                    | -              | -                  | 0  | E0                  | P112 (a), (b) or (c) | -            | -             | -               |
| 0215   | TRINITROBENZOIC ACID, dry or wetted with less than 30% water, by mass  | 1.1D              | -                    | -              | -                  | 0  | E0                  | P112 (a), (b) or (c) | -            | -             | -               |
| 0216   | TRINITRO- <i>m</i> -CRESOL   | 1.1D              | -                    | -              | -                  | 0  | E0                  | P112 (b) or (c)      | PP26         | -             | -               |
| 0217   | TRINITRONAPHTHALENE  | 1.1D              | -                    | -              | -                  | 0  | E0                  | P112 (b) or (c)      | -            | -             | -               |
| 0218   | TRINITROPHENETOLE  | 1.1D              | -                    | -              | -                  | 0  | E0                  | P112 (b) or (c)      | -            | -             | -               |
| 0219   | TRINITRORESORCINOL (STYPHNIC ACID), dry or wetted with less than 20% water, or mixture of alcohol and water, by mass | 1.1D              | -                    | -              | -                  | 0  | E0                  | P112 (a), (b) or (c) | PP26         | -             | -               |
| 0220   | UREA NITRATE, dry or wetted with less than 20% water, by mass  | 1.1D              | -                    | -              | -                  | 0  | E0                  | P112 (a), (b) or (c) | -            | -             | -               |
| 0221   | WARHEADS, TORPEDO with bursting charge   | 1.1D              | -                    | -              | -                  | 0  | E0                  | P130 LP101           | PP67 L1      | -             | -               |
| 0222   | AMMONIUM NITRATE   | 1.1D              | -                    | -              | 370                | 0  | E0                  | P112 (b) or (c)      | PP47         | IBC100        | B2<br>B3<br>B17 |

| UN No. | Portable tanks and bulk containers |               | EmS                    | Stowage and handling    | Segregation      | Properties and observations  | UN No. |
|--------|------------------------------------|---------------|------------------------|-------------------------|------------------|--|--------|
|        | Tank instructions                  | Provisions    |                        |                         |                  |  |        |
| (12)   | (13)<br>4.2.5<br>4.3               | (14)<br>4.2.5 | (15)<br>5.4.3.4<br>7.8 | (16a)<br>7.1<br>7.3-7.7 | (16b)<br>7.2-7.7 | (17)   | (18)   |
| -      | -                                  | -             | F-B, S-X               | Category 02 SW1         | -                | See glossary of terms in appendix B.   | 0191   |
| -      | -                                  | -             | F-B, S-X               | Category 03 SW1         | -                | See glossary of terms in appendix B.   | 0192   |
| -      | -                                  | -             | F-B, S-X               | Category 01 SW1         | -                | See glossary of terms in appendix B.   | 0193   |
| -      | -                                  | -             | F-B, S-X               | Category 03 SW1         | -                | See glossary of terms in appendix B.   | 0194   |
| -      | -                                  | -             | F-B, S-X               | Category 03 SW1         | -                | See glossary of terms in appendix B.   | 0195   |
| -      | -                                  | -             | F-B, S-X               | Category 03 SW1         | -                | See glossary of terms in appendix B.   | 0196   |
| -      | -                                  | -             | F-B, S-X               | Category 02 SW1         | -                | See glossary of terms in appendix B.   | 0197   |
| -      | -                                  | -             | F-B, S-X               | Category 03 SW1         | -                | See glossary of terms in appendix B.   | 0204   |
| -      | -                                  | -             | F-B, S-Y               | Category 04 SW1         | -                | Substance.   | 0207   |
| -      | -                                  | -             | F-B, S-Y               | Category 04 SW1         | -                | Substance. Mass detonating explosive.  | 0208   |
| -      | -                                  | -             | F-B, S-Y               | Category 04 SW1         | -                | Substance. Tritonal is a substance consisting of trinitrotoluene (TNT) mixed with aluminium. | 0209   |
| -      | -                                  | -             | F-B, S-X               | Category 03 SW1         | -                | See glossary of terms in appendix B.   | 0212   |
| -      | -                                  | -             | F-B, S-Y               | Category 04 SW1         | -                | Substance.   | 0213   |
| -      | -                                  | -             | F-B, S-Y               | Category 04 SW1         | -                | Substance.   | 0214   |
| -      | -                                  | -             | F-B, S-Y               | Category 04 SW1         | -                | Substance.   | 0215   |
| -      | -                                  | -             | F-B, S-Y               | Category 04 SW1         | SG31             | Substance.   | 0216   |
| -      | -                                  | -             | F-B, S-Y               | Category 04 SW1         | -                | Substance.   | 0217   |
| -      | -                                  | -             | F-B, S-Y               | Category 04 SW1         | -                | Substance.   | 0218   |
| -      | -                                  | -             | F-B, S-Y               | Category 04 SW1         | SG31             | Substance.   | 0219   |
| -      | -                                  | -             | F-B, S-Y               | Category 04 SW1         | -                | Substance.   | 0220   |
| -      | -                                  | -             | F-B, S-X               | Category 03 SW1         | -                | See glossary of terms in appendix B.   | 0221   |
| -      | -                                  | -             | F-B, S-Y               | Category 04 SW1         | SGG2<br>SG27     | Substance.   | 0222   |

Part 3 – Dangerous Goods List, special provisions and exceptions

Chapter 3.2 – Dangerous Goods List

| UN No. | Proper shipping name (PSN)  | Class or division | Subsidiary hazard(s) | Packing group  | Special provisions | Limited and excepted quantity provisions |                     | Packing         |              | IBC           |               |
|--------|---|-------------------|----------------------|----------------|--------------------|--|---------------------|-----------------|--------------|---------------|---------------|
|        |   |                   |                      |                |                    | Limited quantities                       | Excepted quantities | Instructions    | Provisions   | Instructions  | Provisions    |
| (1)    | (2)<br>3.1.2  | (3)<br>2.0        | (4)<br>2.0           | (5)<br>2.0.1.3 | (6)<br>3.3         | (7a)<br>3.4                              | (7b)<br>3.5         | (8)<br>4.1.4    | (9)<br>4.1.4 | (10)<br>4.1.4 | (11)<br>4.1.4 |
| 0224   | BARIUM AZIDE, dry or wetted with less than 50% water, by mass                                   | 1.1A              | 6.1                  | -              | -                  | 0  | E0                  | P110 (a) or (b) | PP42         | -             | -             |
| 0225   | BOOSTERS WITH DETONATOR   | 1.1B              | -                    | -              | -                  | 0  | E0                  | P133            | PP69         | -             | -             |
| 0226   | CYCLOTETRAMETHYLENE-TETRANITRAMINE (HMX; OCTOGEN), WETTED with not less than 15% water, by mass | 1.1D              | -                    | -              | 266                | 0  | E0                  | P112 (a)        | PP45         | -             | -             |
| 0234   | SODIUM DINITRO- <i>o</i> -CRESOLATE, dry or wetted with less than 15% water, by mass            | 1.3C              | 6.1 P                | -              | -                  | 0  | E0                  | P114 (a) or (b) | PP26         | -             | -             |
| 0235   | SODIUM PICRAMATE, dry or wetted with less than 20% water, by mass                               | 1.3C              | -                    | -              | -                  | 0  | E0                  | P114 (a) or (b) | PP26         | -             | -             |
| 0236   | ZIRCONIUM PICRAMATE, dry or wetted with less than 20% water, by mass                            | 1.3C              | -                    | -              | -                  | 0  | E0                  | P114 (a) or (b) | PP26         | -             | -             |
| 0237   | CHARGES, SHAPED, FLEXIBLE, LINEAR   | 1.4D              | -                    | -              | -                  | 0  | E0                  | P138            | -            | -             | -             |
| 0238   | ROCKETS, LINE-THROWING  | 1.2G              | -                    | -              | -                  | 0  | E0                  | P130 LP101      | -            | -             | -             |
| 0240   | ROCKETS, LINE-THROWING  | 1.3G              | -                    | -              | -                  | 0  | E0                  | P130 LP101      | -            | -             | -             |
| 0241   | EXPLOSIVE, BLASTING, TYPE E   | 1.1D              | -                    | -              | -                  | 0  | E0                  | P116            | PP61<br>PP62 | IBC100        | B10           |
| 0242   | CHARGES, PROPELLING, FOR CANNON   | 1.3C              | -                    | -              | -                  | 0  | E0                  | P130 LP101      | -            | -             | -             |
| 0243   | AMMUNITION, INCENDIARY, WHITE PHOSPHORUS with burster, expelling charge or propelling charge    | 1.2H              | -                    | -              | -                  | 0  | E0                  | P130 LP101      | PP67 L1      | -             | -             |
| 0244   | AMMUNITION, INCENDIARY, WHITE PHOSPHORUS with burster, expelling charge or propelling charge    | 1.3H              | -                    | -              | -                  | 0  | E0                  | P130 LP101      | PP67 L1      | -             | -             |
| 0245   | AMMUNITION, SMOKE, WHITE PHOSPHORUS with burster, expelling charge or propelling charge         | 1.2H              | -                    | -              | -                  | 0  | E0                  | P130 LP101      | PP67 L1      | -             | -             |
| 0246   | AMMUNITION, SMOKE, WHITE PHOSPHORUS with burster, expelling charge or propelling charge         | 1.3H              | -                    | -              | -                  | 0  | E0                  | P130 LP101      | PP67 L1      | -             | -             |
| 0247   | AMMUNITION, INCENDIARY, liquid or gel, with burster, expelling charge or propelling charge      | 1.3J              | -                    | -              | -                  | 0  | E0                  | P101            | -            | -             | -             |
| 0248   | CONTRIVANCES, WATER-ACTIVATED with burster, expelling charge or propelling charge               | 1.2L              | 4.3                  | -              | 274                | 0  | E0                  | P144            | PP77         | -             | -             |

| UN No. | Portable tanks and bulk containers |               | EmS                    | Stowage and handling    | Segregation      | Properties and observations   | UN No. |
|--------|------------------------------------|---------------|------------------------|-------------------------|------------------|---|--------|
|        | Tank instructions                  | Provisions    |                        |                         |                  |   |        |
| (12)   | (13)<br>4.2.5<br>4.3               | (14)<br>4.2.5 | (15)<br>5.4.3.4<br>7.8 | (16a)<br>7.1<br>7.3-7.7 | (16b)<br>7.2-7.7 | (17)  | (18)   |
| -      | -                                  | -             | F-B, S-Z               | Category 05 SW1         | SGG17            | Sensitive substance used in detonators, which becomes extremely sensitive if the wetting agents are lost. This substance, when containing less alcohol, water or phlegmatizer than specified, shall not be transported, unless specifically authorized by the competent authority.            | 0224   |
| -      | -                                  | -             | F-B, S-X               | Category 05 SW1         | -                | See glossary of terms in appendix B.  | 0225   |
| -      | -                                  | -             | F-B, S-Y               | Category 04 SW1         | -                | Substance. Mass detonating explosive which will become more sensitive if the wetting or desensitizing agent is lost. This substance, when containing less alcohol, water or phlegmatizer than specified, shall not be transported, unless specifically authorized by the competent authority. | 0226   |
| -      | -                                  | -             | F-B, S-Z               | Category 04 SW1         | SG31             | Substance.  | 0234   |
| -      | -                                  | -             | F-B, S-Y               | Category 04 SW1         | SG31             | Substance.  | 0235   |
| -      | -                                  | -             | F-B, S-Y               | Category 04 SW1         | SG31             | Substance.  | 0236   |
| -      | -                                  | -             | F-B, S-X               | Category 02 SW1         | -                | See glossary of terms in appendix B.  | 0237   |
| -      | -                                  | -             | F-B, S-X               | Category 03 SW1         | -                | See glossary of terms in appendix B.  | 0238   |
| -      | -                                  | -             | F-B, S-X               | Category 03 SW1         | -                | See glossary of terms in appendix B.  | 0240   |
| -      | -                                  | -             | F-B, S-X               | Category 04 SW1         | SG34             | See glossary of terms in appendix B.  | 0241   |
| -      | -                                  | -             | F-B, S-X               | Category 03 SW1         | -                | See glossary of terms in appendix B.  | 0242   |
| -      | -                                  | -             | F-B, S-X               | Category 05 SW1         | -                | See glossary of terms in appendix B.  | 0243   |
| -      | -                                  | -             | F-B, S-X               | Category 05 SW1         | -                | See glossary of terms in appendix B.  | 0244   |
| -      | -                                  | -             | F-B, S-X               | Category 05 SW1         | -                | See glossary of terms in appendix B.  | 0245   |
| -      | -                                  | -             | F-B, S-X               | Category 05 SW1         | -                | See glossary of terms in appendix B.  | 0246   |
| -      | -                                  | -             | F-B, S-X               | Category 05 SW1         | -                | See glossary of terms in appendix B.  | 0247   |
| -      | -                                  | -             | F-B, S-Y               | Category 05 SW1         | -                | See glossary of terms in appendix B.  | 0248   |



Part 3 – Dangerous Goods List, special provisions and exceptions

Chapter 3.2 – Dangerous Goods List

| UN No. | Proper shipping name (PSN)  | Class or division | Subsidiary hazard(s) | Packing group  | Special provisions | Limited and excepted quantity provisions |                     | Packing                 |              | IBC           |               |
|--------|---|-------------------|----------------------|----------------|--------------------|--|---------------------|-------------------------|--------------|---------------|---------------|
|        |   |                   |                      |                |                    | Limited quantities                       | Excepted quantities | Instructions            | Provisions   | Instructions  | Provisions    |
| (1)    | (2)<br>3.1.2  | (3)<br>2.0        | (4)<br>2.0           | (5)<br>2.0.1.3 | (6)<br>3.3         | (7a)<br>3.4                              | (7b)<br>3.5         | (8)<br>4.1.4            | (9)<br>4.1.4 | (10)<br>4.1.4 | (11)<br>4.1.4 |
| 0249   | CONTRIVANCES, WATER-ACTIVATED with burster, expelling charge or propelling charge       | 1.3L              | 4.3                  | -              | 274                | 0  | E0                  | P144                    | PP77         | -             | -             |
| 0250   | ROCKET MOTORS WITH HYPERGOLIC LIQUIDS with or without expelling charge                  | 1.3L              | -                    | -              | -                  | 0  | E0                  | P101                    | -            | -             | -             |
| 0254   | AMMUNITION, ILLUMINATING with or without burster, expelling charge or propelling charge | 1.3G              | -                    | -              | -                  | 0  | E0                  | P130<br>LP101           | PP67<br>L1   | -             | -             |
| 0255   | DETONATORS, ELECTRIC for blasting   | 1.4B              | -                    | -              | 399                | 0  | E0                  | P131                    | -            | -             | -             |
| 0257   | FUZES, DETONATING   | 1.4B              | -                    | -              | -                  | 0  | E0                  | P141                    | -            | -             | -             |
| 0266   | OCTOLITE (OCTOL), dry or wetted with less than 15% water, by mass                       | 1.1D              | -                    | -              | -                  | 0  | E0                  | P112 (a),<br>(b) or (c) | -            | -             | -             |
| 0267   | DETONATORS, NON-ELECTRIC for blasting   | 1.4B              | -                    | -              | -                  | 0  | E0                  | P131                    | PP68         | -             | -             |
| 0268   | BOOSTERS WITH DETONATOR   | 1.2B              | -                    | -              | -                  | 0  | E0                  | P133                    | PP69         | -             | -             |
| 0271   | CHARGES, PROPELLING   | 1.1C              | -                    | -              | -                  | 0  | E0                  | P143                    | PP76         | -             | -             |
| 0272   | CHARGES, PROPELLING   | 1.3C              | -                    | -              | -                  | 0  | E0                  | P143                    | PP76         | -             | -             |
| 0275   | CARTRIDGES, POWER DEVICE  | 1.3C              | -                    | -              | -                  | 0  | E0                  | P134<br>LP102           | -            | -             | -             |
| 0276   | CARTRIDGES, POWER DEVICE  | 1.4C              | -                    | -              | -                  | 0  | E0                  | P134<br>LP102           | -            | -             | -             |
| 0277   | CARTRIDGES, OIL WELL  | 1.3C              | -                    | -              | -                  | 0  | E0                  | P134<br>LP102           | -            | -             | -             |
| 0278   | CARTRIDGES, OIL WELL  | 1.4C              | -                    | -              | -                  | 0  | E0                  | P134<br>LP102           | -            | -             | -             |
| 0279   | CHARGES, PROPELLING, FOR CANNON   | 1.1C              | -                    | -              | -                  | 0  | E0                  | P130<br>LP101           | -            | -             | -             |
| 0280   | ROCKET MOTORS   | 1.1C              | -                    | -              | -                  | 0  | E0                  | P130<br>LP101           | PP67<br>L1   | -             | -             |
| 0281   | ROCKET MOTORS   | 1.2C              | -                    | -              | -                  | 0  | E0                  | P130<br>LP101           | PP67<br>L1   | -             | -             |
| 0282   | NITROGUANIDINE (PICRITE), dry or wetted with less than 20% water, by mass               | 1.1D              | -                    | -              | -                  | 0  | E0                  | P112 (a),<br>(b) or (c) | -            | -             | -             |
| 0283   | BOOSTERS without detonator  | 1.2D              | -                    | -              | -                  | 0  | E0                  | P132 (a)<br>or (b)      | -            | -             | -             |
| 0284   | GRENADES, hand or rifle, with bursting charge   | 1.1D              | -                    | -              | -                  | 0  | E0                  | P141                    | -            | -             | -             |
| 0285   | GRENADES, hand or rifle, with bursting charge   | 1.2D              | -                    | -              | -                  | 0  | E0                  | P141                    | -            | -             | -             |
| 0286   | WARHEADS, ROCKET with bursting charge   | 1.1D              | -                    | -              | -                  | 0  | E0                  | P130<br>LP101           | PP67<br>L1   | -             | -             |
| 0287   | WARHEADS, ROCKET with bursting charge   | 1.2D              | -                    | -              | -                  | 0  | E0                  | P130<br>LP101           | PP67<br>L1   | -             | -             |
| 0288   | CHARGES, SHAPED, FLEXIBLE, LINEAR   | 1.1D              | -                    | -              | -                  | 0  | E0                  | P138                    | -            | -             | -             |

| UN No. | Portable tanks and bulk containers |               | EmS                    | Stowage and handling    | Segregation      | Properties and observations                        | UN No. |
|--------|------------------------------------|---------------|------------------------|-------------------------|------------------|--|--------|
|        | Tank instructions                  | Provisions    |                        |                         |                  |  |        |
| (12)   | (13)<br>4.2.5<br>4.3               | (14)<br>4.2.5 | (15)<br>5.4.3.4<br>7.8 | (16a)<br>7.1<br>7.3-7.7 | (16b)<br>7.2-7.7 | (17)   | (18)   |
| -      | -                                  | -             | F-B, S-Y               | Category 05 SW1         | -                | See glossary of terms in appendix B.               | 0249   |
| -      | -                                  | -             | F-B, S-X               | Category 05 SW1         | -                | See glossary of terms in appendix B.               | 0250   |
| -      | -                                  | -             | F-B, S-X               | Category 03 SW1         | -                | See glossary of terms in appendix B.               | 0254   |
| -      | -                                  | -             | F-B, S-X               | Category 05 SW1         | -                | See glossary of terms in appendix B.               | 0255   |
| -      | -                                  | -             | F-B, S-X               | Category 05 SW1         | -                | See glossary of terms in appendix B.               | 0257   |
| -      | -                                  | -             | F-B, S-Y               | Category 04 SW1         | -                | Substance. Mixtures of mass detonating explosives. | 0266   |
| -      | -                                  | -             | F-B, S-X               | Category 05 SW1         | -                | See glossary of terms in appendix B.               | 0267   |
| -      | -                                  | -             | F-B, S-X               | Category 05 SW1         | -                | See glossary of terms in appendix B.               | 0268   |
| -      | -                                  | -             | F-B, S-X               | Category 03 SW1         | -                | See glossary of terms in appendix B.               | 0271   |
| -      | -                                  | -             | F-B, S-X               | Category 03 SW1         | -                | See glossary of terms in appendix B.               | 0272   |
| -      | -                                  | -             | F-B, S-X               | Category 03 SW1         | -                | See glossary of terms in appendix B.               | 0275   |
| -      | -                                  | -             | F-B, S-X               | Category 02 SW1         | -                | See glossary of terms in appendix B.               | 0276   |
| -      | -                                  | -             | F-B, S-X               | Category 03 SW1         | -                | See glossary of terms in appendix B.               | 0277   |
| -      | -                                  | -             | F-B, S-X               | Category 02 SW1         | -                | See glossary of terms in appendix B.               | 0278   |
| -      | -                                  | -             | F-B, S-X               | Category 03 SW1         | -                | See glossary of terms in appendix B.               | 0279   |
| -      | -                                  | -             | F-B, S-X               | Category 03 SW1         | -                | See glossary of terms in appendix B.               | 0280   |
| -      | -                                  | -             | F-B, S-X               | Category 04 SW1         | -                | See glossary of terms in appendix B.               | 0281   |
| -      | -                                  | -             | F-B, S-Y               | Category 04 SW1         | -                | Substance.   | 0282   |
| -      | -                                  | -             | F-B, S-X               | Category 03 SW1         | -                | See glossary of terms in appendix B.               | 0283   |
| -      | -                                  | -             | F-B, S-X               | Category 03 SW1         | -                | See glossary of terms in appendix B.               | 0284   |
| -      | -                                  | -             | F-B, S-X               | Category 03 SW1         | -                | See glossary of terms in appendix B.               | 0285   |
| -      | -                                  | -             | F-B, S-X               | Category 03 SW1         | -                | See glossary of terms in appendix B.               | 0286   |
| -      | -                                  | -             | F-B, S-X               | Category 03 SW1         | -                | See glossary of terms in appendix B.               | 0287   |
| -      | -                                  | -             | F-B, S-X               | Category 04 SW1         | -                | See glossary of terms in appendix B.               | 0288   |

Part 3 – Dangerous Goods List, special provisions and exceptions

Chapter 3.2 – Dangerous Goods List

| UN No. | Proper shipping name (PSN)  | Class or division | Subsidiary hazard(s) | Packing group  | Special provisions | Limited and excepted quantity provisions |                     | Packing       |              | IBC           |               |
|--------|---|-------------------|----------------------|----------------|--------------------|--|---------------------|---------------|--------------|---------------|---------------|
|        |   |                   |                      |                |                    | Limited quantities                       | Excepted quantities | Instructions  | Provisions   | Instructions  | Provisions    |
| (1)    | (2)<br>3.1.2  | (3)<br>2.0        | (4)<br>2.0           | (5)<br>2.0.1.3 | (6)<br>3.3         | (7a)<br>3.4                              | (7b)<br>3.5         | (8)<br>4.1.4  | (9)<br>4.1.4 | (10)<br>4.1.4 | (11)<br>4.1.4 |
| 0289   | CORD, DETONATING, flexible  | 1.4D              | -                    | -              | -                  | 0  | E0                  | P139          | PP71<br>PP72 | -             | -             |
| 0290   | CORD (FUSE), DETONATING, metal-clad   | 1.1D              | -                    | -              | -                  | 0  | E0                  | P139          | PP71         | -             | -             |
| 0291   | BOMBS with bursting charge  | 1.2F              | -                    | -              | -                  | 0  | E0                  | P130<br>LP101 | -            | -             | -             |
| 0292   | GRENADES, hand or rifle, with bursting charge   | 1.1F              | -                    | -              | -                  | 0  | E0                  | P141          | -            | -             | -             |
| 0293   | GRENADES, hand or rifle, with bursting charge   | 1.2F              | -                    | -              | -                  | 0  | E0                  | P141          | -            | -             | -             |
| 0294   | MINES with bursting charge  | 1.2F              | -                    | -              | -                  | 0  | E0                  | P130<br>LP101 | -            | -             | -             |
| 0295   | ROCKETS with bursting charge  | 1.2F              | -                    | -              | -                  | 0  | E0                  | P130<br>LP101 | -            | -             | -             |
| 0296   | SOUNDING DEVICES, EXPLOSIVE   | 1.1F              | -                    | -              | -                  | 0  | E0                  | P134<br>LP102 | -            | -             | -             |
| 0297   | AMMUNITION, ILLUMINATING with or without burster, expelling charge or propelling charge | 1.4G              | -                    | -              | -                  | 0  | E0                  | P130<br>LP101 | PP67<br>L1   | -             | -             |
| 0299   | BOMBS, PHOTO-FLASH  | 1.3G              | -                    | -              | -                  | 0  | E0                  | P130<br>LP101 | PP67<br>L1   | -             | -             |
| 0300   | AMMUNITION, INCENDIARY with or without burster, expelling charge or propelling charge   | 1.4G              | -                    | -              | -                  | 0  | E0                  | P130<br>LP101 | PP67<br>L1   | -             | -             |
| 0301   | AMMUNITION, TEAR-PRODUCING with burster, expelling charge or propelling charge          | 1.4G              | 6.1/8                | -              | -                  | 0  | E0                  | P130<br>LP101 | PP67<br>L1   | -             | -             |
| 0303   | AMMUNITION, SMOKE with or without burster, expelling charge or propelling charge        | 1.4G              | See SP204            | -              | 204                | 0  | E0                  | P130<br>LP101 | PP67<br>L1   | -             | -             |
| 0305   | FLASH POWDER  | 1.3G              | -                    | -              | -                  | 0  | E0                  | P113          | PP49         | -             | -             |
| 0306   | TRACERS FOR AMMUNITION  | 1.4G              | -                    | -              | -                  | 0  | E0                  | P133          | PP69         | -             | -             |
| 0312   | CARTRIDGES, SIGNAL  | 1.4G              | -                    | -              | -                  | 0  | E0                  | P135          | -            | -             | -             |
| 0313   | SIGNALS, SMOKE  | 1.2G              | -                    | -              | -                  | 0  | E0                  | P135          | -            | -             | -             |
| 0314   | IGNITERS  | 1.2G              | -                    | -              | -                  | 0  | E0                  | P142          | -            | -             | -             |
| 0315   | IGNITERS  | 1.3G              | -                    | -              | -                  | 0  | E0                  | P142          | -            | -             | -             |
| 0316   | FUZES, IGNITING   | 1.3G              | -                    | -              | -                  | 0  | E0                  | P141          | -            | -             | -             |
| 0317   | FUZES, IGNITING   | 1.4G              | -                    | -              | -                  | 0  | E0                  | P141          | -            | -             | -             |
| 0318   | GRENADES, PRACTICE, hand or rifle   | 1.3G              | -                    | -              | -                  | 0  | E0                  | P141          | -            | -             | -             |
| 0319   | PRIMERS, TUBULAR  | 1.3G              | -                    | -              | -                  | 0  | E0                  | P133          | -            | -             | -             |
| 0320   | PRIMERS, TUBULAR  | 1.4G              | -                    | -              | -                  | 0  | E0                  | P133          | -            | -             | -             |

| UN No. | Portable tanks and bulk containers |               | EmS                    | Stowage and handling    | Segregation      | Properties and observations          | UN No. |
|--------|------------------------------------|---------------|------------------------|-------------------------|------------------|--------------------------------------|--------|
|        | Tank instructions                  | Provisions    |                        |                         |                  |                                      |        |
| (12)   | (13)<br>4.2.5<br>4.3               | (14)<br>4.2.5 | (15)<br>5.4.3.4<br>7.8 | (16a)<br>7.1<br>7.3-7.7 | (16b)<br>7.2-7.7 | (17)                                 | (18)   |
| -      | -                                  | -             | F-B, S-X               | Category 02 SW1         | -                | See glossary of terms in appendix B. | 0289   |
| -      | -                                  | -             | F-B, S-X               | Category 03 SW1         | -                | See glossary of terms in appendix B. | 0290   |
| -      | -                                  | -             | F-B, S-X               | Category 03 SW1         | -                | See glossary of terms in appendix B. | 0291   |
| -      | -                                  | -             | F-B, S-X               | Category 03 SW1         | -                | See glossary of terms in appendix B. | 0292   |
| -      | -                                  | -             | F-B, S-X               | Category 03 SW1         | -                | See glossary of terms in appendix B. | 0293   |
| -      | -                                  | -             | F-B, S-X               | Category 03 SW1         | -                | See glossary of terms in appendix B. | 0294   |
| -      | -                                  | -             | F-B, S-X               | Category 03 SW1         | -                | See glossary of terms in appendix B. | 0295   |
| -      | -                                  | -             | F-B, S-X               | Category 03 SW1         | -                | See glossary of terms in appendix B. | 0296   |
| -      | -                                  | -             | F-B, S-X               | Category 02 SW1         | -                | See glossary of terms in appendix B. | 0297   |
| -      | -                                  | -             | F-B, S-X               | Category 03 SW1         | -                | See glossary of terms in appendix B. | 0299   |
| -      | -                                  | -             | F-B, S-X               | Category 02 SW1         | -                | See glossary of terms in appendix B. | 0300   |
| -      | -                                  | -             | F-B, S-Z               | Category 02 SW1         | SG74             | See glossary of terms in appendix B. | 0301   |
| -      | -                                  | -             | F-B, S-X               | Category 02 SW1         | -                | See glossary of terms in appendix B. | 0303   |
| -      | -                                  | -             | F-B, S-Y               | Category 03 SW1         | -                | See glossary of terms in appendix B. | 0305   |
| -      | -                                  | -             | F-B, S-X               | Category 02 SW1         | -                | See glossary of terms in appendix B. | 0306   |
| -      | -                                  | -             | F-B, S-X               | Category 02 SW1         | -                | See glossary of terms in appendix B. | 0312   |
| -      | -                                  | -             | F-B, S-X               | Category 03 SW1         | -                | See glossary of terms in appendix B. | 0313   |
| -      | -                                  | -             | F-B, S-X               | Category 03 SW1         | -                | See glossary of terms in appendix B. | 0314   |
| -      | -                                  | -             | F-B, S-X               | Category 03 SW1         | -                | See glossary of terms in appendix B. | 0315   |
| -      | -                                  | -             | F-B, S-X               | Category 03 SW1         | -                | See glossary of terms in appendix B. | 0316   |
| -      | -                                  | -             | F-B, S-X               | Category 02 SW1         | -                | See glossary of terms in appendix B. | 0317   |
| -      | -                                  | -             | F-B, S-X               | Category 03 SW1         | -                | See glossary of terms in appendix B. | 0318   |
| -      | -                                  | -             | F-B, S-X               | Category 03 SW1         | -                | See glossary of terms in appendix B. | 0319   |
| -      | -                                  | -             | F-B, S-X               | Category 02 SW1         | -                | See glossary of terms in appendix B. | 0320   |



Part 3 – Dangerous Goods List, special provisions and exceptions

Chapter 3.2 – Dangerous Goods List

| UN No. | Proper shipping name (PSN)   | Class or division | Subsidiary hazard(s) | Packing group  | Special provisions | Limited and excepted quantity provisions |                     | Packing         |                | IBC           |               |
|--------|--|-------------------|----------------------|----------------|--------------------|--|---------------------|-----------------|----------------|---------------|---------------|
|        |  |                   |                      |                |                    | Limited quantities                       | Excepted quantities | Instructions    | Provisions     | Instructions  | Provisions    |
| (1)    | (2)<br>3.1.2   | (3)<br>2.0        | (4)<br>2.0           | (5)<br>2.0.1.3 | (6)<br>3.3         | (7a)<br>3.4                              | (7b)<br>3.5         | (8)<br>4.1.4    | (9)<br>4.1.4   | (10)<br>4.1.4 | (11)<br>4.1.4 |
| 0321   | CARTRIDGES FOR WEAPONS with bursting charge  | 1.2E              | -                    | -              | -                  | 0  | E0                  | P130 LP101      | PP67 L1        | -             | -             |
| 0322   | ROCKET MOTORS WITH HYPERGOLIC LIQUIDS with or without expelling charge                       | 1.2L              | -                    | -              | -                  | 0  | E0                  | P101            | -              | -             | -             |
| 0323   | CARTRIDGES, POWER DEVICE   | 1.4S              | -                    | -              | 347                | 0  | E0                  | P134 LP102      | -              | -             | -             |
| 0324   | PROJECTILES with bursting charge   | 1.2F              | -                    | -              | -                  | 0  | E0                  | P130 LP101      | -              | -             | -             |
| 0325   | IGNITERS   | 1.4G              | -                    | -              | -                  | 0  | E0                  | P142            | -              | -             | -             |
| 0326   | CARTRIDGES FOR WEAPONS, BLANK  | 1.1C              | -                    | -              | -                  | 0  | E0                  | P130 LP101      | -              | -             | -             |
| 0327   | CARTRIDGES FOR WEAPONS, BLANK or CARTRIDGES, SMALL ARMS, BLANK                               | 1.3C              | -                    | -              | -                  | 0  | E0                  | P130 LP101      | -              | -             | -             |
| 0328   | CARTRIDGES FOR WEAPONS, INERT PROJECTILE   | 1.2C              | -                    | -              | -                  | 0  | E0                  | P130 LP101      | PP67 L1        | -             | -             |
| 0329   | TORPEDOES with bursting charge   | 1.1E              | -                    | -              | -                  | 0  | E0                  | P130 LP101      | PP67 L1        | -             | -             |
| 0330   | TORPEDOES with bursting charge   | 1.1F              | -                    | -              | -                  | 0  | E0                  | P130 LP101      | -              | -             | -             |
| △ 0331 | EXPLOSIVE, BLASTING, TYPE B (AGENT, BLASTING, TYPE B)  | 1.5D              | -                    | -              | -                  | 0  | E0                  | P116            | PP61 PP62 PP64 | IBC100        | -             |
| 0332   | EXPLOSIVE, BLASTING, TYPE E (AGENT, BLASTING, TYPE E)  | 1.5D              | -                    | -              | -                  | 0  | E0                  | P116            | PP61 PP62      | IBC100        | -             |
| 0333   | FIREWORKS  | 1.1G              | -                    | -              | -                  | 0  | E0                  | P135            | -              | -             | -             |
| 0334   | FIREWORKS  | 1.2G              | -                    | -              | -                  | 0  | E0                  | P135            | -              | -             | -             |
| 0335   | FIREWORKS  | 1.3G              | -                    | -              | -                  | 0  | E0                  | P135            | -              | -             | -             |
| 0336   | FIREWORKS  | 1.4G              | -                    | -              | -                  | 0  | E0                  | P135            | -              | -             | -             |
| 0337   | FIREWORKS  | 1.4S              | -                    | -              | -                  | 0  | E0                  | P135            | -              | -             | -             |
| 0338   | CARTRIDGES FOR WEAPONS, BLANK or CARTRIDGES, SMALL ARMS, BLANK                               | 1.4C              | -                    | -              | -                  | 0  | E0                  | P130 LP101      | -              | -             | -             |
| 0339   | CARTRIDGES FOR WEAPONS, INERT PROJECTILE or CARTRIDGES, SMALL ARMS                           | 1.4C              | -                    | -              | -                  | 0  | E0                  | P130 LP101      | -              | -             | -             |
| 0340   | NITROCELLULOSE, dry or wetted with less than 25% water (or alcohol), by mass                 | 1.1D              | -                    | -              | 393                | 0  | E0                  | P112 (a) or (b) | -              | -             | -             |
| 0341   | NITROCELLULOSE, unmodified or plasticized with less than 18% plasticizing substance, by mass | 1.1D              | -                    | -              | 393                | 0  | E0                  | P112 (b)        | -              | -             | -             |
| 0342   | NITROCELLULOSE, WETTED with not less than 25% alcohol, by mass                               | 1.3C              | -                    | -              | 105 393            | 0  | E0                  | P114 (a)        | PP43           | -             | -             |

| UN No. | Portable tanks and bulk containers |               | EmS                    | Stowage and handling    | Segregation      | Properties and observations          | UN No. |
|--------|------------------------------------|---------------|------------------------|-------------------------|------------------|--------------------------------------|--------|
|        | Tank instructions                  | Provisions    |                        |                         |                  |                                      |        |
| (12)   | (13)<br>4.2.5<br>4.3               | (14)<br>4.2.5 | (15)<br>5.4.3.4<br>7.8 | (16a)<br>7.1<br>7.3-7.7 | (16b)<br>7.2-7.7 | (17)                                 | (18)   |
| -      | -                                  | -             | F-B, S-X               | Category 03 SW1         | -                | See glossary of terms in appendix B. | 0321   |
| -      | -                                  | -             | F-B, S-X               | Category 05 SW1         | -                | See glossary of terms in appendix B. | 0322   |
| -      | -                                  | -             | F-B, S-X               | Category 01 SW1         | -                | See glossary of terms in appendix B. | 0323   |
| -      | -                                  | -             | F-B, S-X               | Category 03 SW1         | -                | See glossary of terms in appendix B. | 0324   |
| -      | -                                  | -             | F-B, S-X               | Category 02 SW1         | -                | See glossary of terms in appendix B. | 0325   |
| -      | -                                  | -             | F-B, S-X               | Category 03 SW1         | -                | See glossary of terms in appendix B. | 0326   |
| -      | -                                  | -             | F-B, S-X               | Category 03 SW1         | -                | See glossary of terms in appendix B. | 0327   |
| -      | -                                  | -             | F-B, S-X               | Category 03 SW1         | -                | See glossary of terms in appendix B. | 0328   |
| -      | -                                  | -             | F-B, S-X               | Category 03 SW1         | -                | See glossary of terms in appendix B. | 0329   |
| -      | -                                  | -             | F-B, S-X               | Category 03 SW1         | -                | See glossary of terms in appendix B. | 0330   |
| -      | T1                                 | TP17 TP32     | F-B, S-Y               | Category 03 SW1         | SG34             | See glossary of terms in appendix B. | 0331 △ |
| -      | T1                                 | TP1 TP17 TP32 | F-B, S-Y               | Category 03 SW1         | SG34             | See glossary of terms in appendix B. | 0332   |
| -      | -                                  | -             | F-B, S-X               | Category 03 SW1         | -                | See glossary of terms in appendix B. | 0333   |
| -      | -                                  | -             | F-B, S-X               | Category 03 SW1         | -                | See glossary of terms in appendix B. | 0334   |
| -      | -                                  | -             | F-B, S-X               | Category 03 SW1         | -                | See glossary of terms in appendix B. | 0335   |
| -      | -                                  | -             | F-B, S-X               | Category 02 SW1         | -                | See glossary of terms in appendix B. | 0336   |
| -      | -                                  | -             | F-B, S-X               | Category 01 SW1         | -                | See glossary of terms in appendix B. | 0337   |
| -      | -                                  | -             | F-B, S-X               | Category 02 SW1         | -                | See glossary of terms in appendix B. | 0338   |
| -      | -                                  | -             | F-B, S-X               | Category 02 SW1         | -                | See glossary of terms in appendix B. | 0339   |
| -      | -                                  | -             | F-B, S-Y               | Category 04 SW1         | -                | Substance.                           | 0340   |
| -      | -                                  | -             | F-B, S-Y               | Category 04 SW1         | -                | Substance.                           | 0341   |
| -      | -                                  | -             | F-B, S-Y               | Category 04 SW1         | -                | Substance.                           | 0342   |

Part 3 – Dangerous Goods List, special provisions and exceptions

Chapter 3.2 – Dangerous Goods List

| UN No. | Proper shipping name (PSN)   | Class or division | Subsidiary hazard(s) | Packing group  | Special provisions | Limited and excepted quantity provisions |                     | Packing       |              | IBC           |               |
|--------|--|-------------------|----------------------|----------------|--------------------|--|---------------------|---------------|--------------|---------------|---------------|
|        |  |                   |                      |                |                    | Limited quantities                       | Excepted quantities | Instructions  | Provisions   | Instructions  | Provisions    |
| (1)    | (2)<br>3.1.2   | (3)<br>2.0        | (4)<br>2.0           | (5)<br>2.0.1.3 | (6)<br>3.3         | (7a)<br>3.4                              | (7b)<br>3.5         | (8)<br>4.1.4  | (9)<br>4.1.4 | (10)<br>4.1.4 | (11)<br>4.1.4 |
| 0343   | NITROCELLULOSE, PLASTICIZED with not less than 18% plasticizing substance, by mass | 1.3C              | -                    | -              | 105<br>393         | 0  | E0                  | P111          | -            | -             | -             |
| 0344   | PROJECTILES with bursting charge   | 1.4D              | -                    | -              | -                  | 0  | E0                  | P130<br>LP101 | PP67<br>L1   | -             | -             |
| 0345   | PROJECTILES, inert with tracer   | 1.4S              | -                    | -              | -                  | 0  | E0                  | P130<br>LP101 | PP67<br>L1   | -             | -             |
| 0346   | PROJECTILES with burster or expelling charge                                       | 1.2D              | -                    | -              | -                  | 0  | E0                  | P130<br>LP101 | PP67<br>L1   | -             | -             |
| 0347   | PROJECTILES with burster or expelling charge                                       | 1.4D              | -                    | -              | -                  | 0  | E0                  | P130<br>LP101 | PP67<br>L1   | -             | -             |
| 0348   | CARTRIDGES FOR WEAPONS with bursting charge  | 1.4F              | -                    | -              | -                  | 0  | E0                  | P130<br>LP101 | -            | -             | -             |
| 0349   | ARTICLES, EXPLOSIVE, N.O.S.  | 1.4S              | -                    | -              | 178<br>274<br>347  | 0  | E0                  | P101          | -            | -             | -             |
| 0350   | ARTICLES, EXPLOSIVE, N.O.S.  | 1.4B              | -                    | -              | 178<br>274         | 0  | E0                  | P101          | -            | -             | -             |
| 0351   | ARTICLES, EXPLOSIVE, N.O.S.  | 1.4C              | -                    | -              | 178<br>274         | 0  | E0                  | P101          | -            | -             | -             |
| 0352   | ARTICLES, EXPLOSIVE, N.O.S.  | 1.4D              | -                    | -              | 178<br>274         | 0  | E0                  | P101          | -            | -             | -             |
| 0353   | ARTICLES, EXPLOSIVE, N.O.S.  | 1.4G              | -                    | -              | 178<br>274         | 0  | E0                  | P101          | -            | -             | -             |
| 0354   | ARTICLES, EXPLOSIVE, N.O.S.  | 1.1L              | See SP943            | -              | 178<br>274         | 0  | E0                  | P101          | -            | -             | -             |
| 0355   | ARTICLES, EXPLOSIVE, N.O.S.  | 1.2L              | See SP943            | -              | 178<br>274         | 0  | E0                  | P101          | -            | -             | -             |
| 0356   | ARTICLES, EXPLOSIVE, N.O.S.  | 1.3L              | See SP943            | -              | 178<br>274         | 0  | E0                  | P101          | -            | -             | -             |
| 0357   | SUBSTANCES, EXPLOSIVE, N.O.S.  | 1.1L              | -                    | -              | 178<br>274         | 0  | E0                  | P101          | -            | -             | -             |
| 0358   | SUBSTANCES, EXPLOSIVE, N.O.S.  | 1.2L              | -                    | -              | 178<br>274         | 0  | E0                  | P101          | -            | -             | -             |
| 0359   | SUBSTANCES, EXPLOSIVE, N.O.S.  | 1.3L              | -                    | -              | 178<br>274         | 0  | E0                  | P101          | -            | -             | -             |
| 0360   | DETONATOR ASSEMBLIES, NON-ELECTRIC for blasting                                    | 1.1B              | -                    | -              | -                  | 0  | E0                  | P131          | -            | -             | -             |
| 0361   | DETONATOR ASSEMBLIES, NON-ELECTRIC for blasting                                    | 1.4B              | -                    | -              | -                  | 0  | E0                  | P131          | -            | -             | -             |
| 0362   | AMMUNITION, PRACTICE   | 1.4G              | -                    | -              | -                  | 0  | E0                  | P130<br>LP101 | PP67<br>L1   | -             | -             |
| 0363   | AMMUNITION, PROOF  | 1.4G              | -                    | -              | -                  | 0  | E0                  | P130<br>LP101 | PP67<br>L1   | -             | -             |
| 0364   | DETONATORS FOR AMMUNITION  | 1.2B              | -                    | -              | -                  | 0  | E0                  | P133          | -            | -             | -             |
| 0365   | DETONATORS FOR AMMUNITION  | 1.4B              | -                    | -              | -                  | 0  | E0                  | P133          | -            | -             | -             |
| 0366   | DETONATORS FOR AMMUNITION  | 1.4S              | -                    | -              | 347                | 0  | E0                  | P133          | -            | -             | -             |
| 0367   | FUZES, DETONATING  | 1.4S              | -                    | -              | 347                | 0  | E0                  | P141          | -            | -             | -             |

| UN No. | Portable tanks and bulk containers |               | EmS                    | Stowage and handling    | Segregation      | Properties and observations          | UN No. |
|--------|------------------------------------|---------------|------------------------|-------------------------|------------------|--------------------------------------|--------|
|        | Tank instructions                  | Provisions    |                        |                         |                  |                                      |        |
| (12)   | (13)<br>4.2.5<br>4.3               | (14)<br>4.2.5 | (15)<br>5.4.3.4<br>7.8 | (16a)<br>7.1<br>7.3-7.7 | (16b)<br>7.2-7.7 | (17)                                 | (18)   |
| -      | -                                  | -             | F-B, S-Y               | Category 04 SW1         | -                | Substance.                           | 0343   |
| -      | -                                  | -             | F-B, S-X               | Category 02 SW1         | -                | See glossary of terms in appendix B. | 0344   |
| -      | -                                  | -             | F-B, S-X               | Category 01 SW1         | -                | See glossary of terms in appendix B. | 0345   |
| -      | -                                  | -             | F-B, S-X               | Category 03 SW1         | -                | See glossary of terms in appendix B. | 0346   |
| -      | -                                  | -             | F-B, S-X               | Category 02 SW1         | -                | See glossary of terms in appendix B. | 0347   |
| -      | -                                  | -             | F-B, S-X               | Category 03 SW1         | -                | See glossary of terms in appendix B. | 0348   |
| -      | -                                  | -             | F-B, S-X               | Category 01 SW1         | -                | -                                    | 0349   |
| -      | -                                  | -             | F-B, S-X               | Category 05 SW1         | -                | -                                    | 0350   |
| -      | -                                  | -             | F-B, S-X               | Category 02 SW1         | -                | -                                    | 0351   |
| -      | -                                  | -             | F-B, S-X               | Category 02 SW1         | -                | -                                    | 0352   |
| -      | -                                  | -             | F-B, S-X               | Category 02 SW1         | -                | -                                    | 0353   |
| -      | -                                  | -             | F-B, S-X               | Category 05 SW1         | -                | -                                    | 0354   |
| -      | -                                  | -             | F-B, S-X               | Category 05 SW1         | -                | -                                    | 0355   |
| -      | -                                  | -             | F-B, S-X               | Category 05 SW1         | -                | -                                    | 0356   |
| -      | -                                  | -             | F-B, S-Y               | Category 05 SW1         | -                | -                                    | 0357   |
| -      | -                                  | -             | F-B, S-Y               | Category 05 SW1         | -                | -                                    | 0358   |
| -      | -                                  | -             | F-B, S-Y               | Category 05 SW1         | -                | -                                    | 0359   |
| -      | -                                  | -             | F-B, S-X               | Category 05 SW1         | -                | See glossary of terms in appendix B. | 0360   |
| -      | -                                  | -             | F-B, S-X               | Category 05 SW1         | -                | See glossary of terms in appendix B. | 0361   |
| -      | -                                  | -             | F-B, S-X               | Category 02 SW1         | -                | See glossary of terms in appendix B. | 0362   |
| -      | -                                  | -             | F-B, S-X               | Category 02 SW1         | -                | See glossary of terms in appendix B. | 0363   |
| -      | -                                  | -             | F-B, S-X               | Category 05 SW1         | -                | See glossary of terms in appendix B. | 0364   |
| -      | -                                  | -             | F-B, S-X               | Category 05 SW1         | -                | See glossary of terms in appendix B. | 0365   |
| -      | -                                  | -             | F-B, S-X               | Category 01 SW1         | -                | See glossary of terms in appendix B. | 0366   |
| -      | -                                  | -             | F-B, S-X               | Category 01 SW1         | -                | See glossary of terms in appendix B. | 0367   |

Part 3 – Dangerous Goods List, special provisions and exceptions

Chapter 3.2 – Dangerous Goods List

| UN No. | Proper shipping name (PSN)   | Class or division | Subsidiary hazard(s) | Packing group  | Special provisions | Limited and excepted quantity provisions |                     | Packing         |              | IBC           |               |
|--------|--|-------------------|----------------------|----------------|--------------------|--|---------------------|-----------------|--------------|---------------|---------------|
|        |  |                   |                      |                |                    | Limited quantities                       | Excepted quantities | Instructions    | Provisions   | Instructions  | Provisions    |
| (1)    | (2)<br>3.1.2   | (3)<br>2.0        | (4)<br>2.0           | (5)<br>2.0.1.3 | (6)<br>3.3         | (7a)<br>3.4                              | (7b)<br>3.5         | (8)<br>4.1.4    | (9)<br>4.1.4 | (10)<br>4.1.4 | (11)<br>4.1.4 |
| 0368   | FUZES, IGNITING  | 1.4S              | -                    | -              | -                  | 0  | E0                  | P141            | -            | -             | -             |
| 0369   | WARHEADS, ROCKET with bursting charge  | 1.1F              | -                    | -              | -                  | 0  | E0                  | P130 LP101      | -            | -             | -             |
| 0370   | WARHEADS, ROCKET with burster or expelling charge  | 1.4D              | -                    | -              | -                  | 0  | E0                  | P130 LP101      | PP67 L1      | -             | -             |
| 0371   | WARHEADS, ROCKET with burster or expelling charge  | 1.4F              | -                    | -              | -                  | 0  | E0                  | P130 LP101      | -            | -             | -             |
| 0372   | GRENADERS, PRACTICE, hand or rifle   | 1.2G              | -                    | -              | -                  | 0  | E0                  | P141            | -            | -             | -             |
| 0373   | SIGNAL DEVICES, HAND   | 1.4S              | -                    | -              | -                  | 0  | E0                  | P135            | -            | -             | -             |
| 0374   | SOUNDING DEVICES, EXPLOSIVE  | 1.1D              | -                    | -              | -                  | 0  | E0                  | P134 LP102      | -            | -             | -             |
| 0375   | SOUNDING DEVICES, EXPLOSIVE  | 1.2D              | -                    | -              | -                  | 0  | E0                  | P134 LP102      | -            | -             | -             |
| 0376   | PRIMERS, TUBULAR   | 1.4S              | -                    | -              | -                  | 0  | E0                  | P133            | -            | -             | -             |
| 0377   | PRIMERS, CAP TYPE  | 1.1B              | -                    | -              | -                  | 0  | E0                  | P133            | -            | -             | -             |
| 0378   | PRIMERS, CAP TYPE  | 1.4B              | -                    | -              | -                  | 0  | E0                  | P133            | -            | -             | -             |
| 0379   | CASES, CARTRIDGE, EMPTY, WITH PRIMER   | 1.4C              | -                    | -              | -                  | 0  | E0                  | P136            | -            | -             | -             |
| 0380   | ARTICLES, PYROPHORIC   | 1.2L              | -                    | -              | -                  | 0  | E0                  | P101            | -            | -             | -             |
| 0381   | CARTRIDGES, POWER DEVICE   | 1.2C              | -                    | -              | -                  | 0  | E0                  | P134 LP102      | -            | -             | -             |
| 0382   | COMPONENTS, EXPLOSIVE TRAIN, N.O.S.  | 1.2B              | -                    | -              | 178<br>274         | 0  | E0                  | P101            | -            | -             | -             |
| 0383   | COMPONENTS, EXPLOSIVE TRAIN, N.O.S.  | 1.4B              | -                    | -              | 178<br>274         | 0  | E0                  | P101            | -            | -             | -             |
| 0384   | COMPONENTS, EXPLOSIVE TRAIN, N.O.S.  | 1.4S              | -                    | -              | 178<br>274<br>347  | 0  | E0                  | P101            | -            | -             | -             |
| 0385   | 5-NITROBENZOTRIAZOL  | 1.1D              | -                    | -              | -                  | 0  | E0                  | P112 (b) or (c) | -            | -             | -             |
| 0386   | TRINITROBENZENESULPHONIC ACID  | 1.1D              | -                    | -              | -                  | 0  | E0                  | P112 (b) or (c) | PP26         | -             | -             |
| 0387   | TRINITROFLUORENONE   | 1.1D              | -                    | -              | -                  | 0  | E0                  | P112 (b) or (c) | -            | -             | -             |
| 0388   | TRINITROTOLUENE (TNT) AND TRINITROBENZENE MIXTURE or TRINITROTOLUENE (TNT) AND HEXANITROSTILBENE MIXTURE | 1.1D              | -                    | -              | -                  | 0  | E0                  | P112 (b) or (c) | -            | -             | -             |
| 0389   | TRINITROTOLUENE (TNT) MIXTURE CONTAINING TRINITROBENZENE AND HEXANITROSTILBENE                           | 1.1D              | -                    | -              | -                  | 0  | E0                  | P112 (b) or (c) | -            | -             | -             |
| 0390   | TRITONAL   | 1.1D              | -                    | -              | -                  | 0  | E0                  | P112 (b) or (c) | -            | -             | -             |

| UN No. | Portable tanks and bulk containers |               | EmS                    | Stowage and handling    | Segregation      | Properties and observations   | UN No. |
|--------|------------------------------------|---------------|------------------------|-------------------------|------------------|---|--------|
|        | Tank instructions                  | Provisions    |                        |                         |                  |   |        |
| (12)   | (13)<br>4.2.5<br>4.3               | (14)<br>4.2.5 | (15)<br>5.4.3.4<br>7.8 | (16a)<br>7.1<br>7.3-7.7 | (16b)<br>7.2-7.7 | (17)  | (18)   |
| -      | -                                  | -             | F-B, S-X               | Category 01 SW1         | -                | See glossary of terms in appendix B.  | 0368   |
| -      | -                                  | -             | F-B, S-X               | Category 03 SW1         | -                | See glossary of terms in appendix B.  | 0369   |
| -      | -                                  | -             | F-B, S-X               | Category 02 SW1         | -                | See glossary of terms in appendix B.  | 0370   |
| -      | -                                  | -             | F-B, S-X               | Category 03 SW1         | -                | See glossary of terms in appendix B.  | 0371   |
| -      | -                                  | -             | F-B, S-X               | Category 03 SW1         | -                | See glossary of terms in appendix B.  | 0372   |
| -      | -                                  | -             | F-B, S-X               | Category 01 SW1         | -                | See glossary of terms in appendix B.  | 0373   |
| -      | -                                  | -             | F-B, S-X               | Category 03 SW1         | -                | See glossary of terms in appendix B.  | 0374   |
| -      | -                                  | -             | F-B, S-X               | Category 03 SW1         | -                | See glossary of terms in appendix B.  | 0375   |
| -      | -                                  | -             | F-B, S-X               | Category 01 SW1         | -                | See glossary of terms in appendix B.  | 0376   |
| -      | -                                  | -             | F-B, S-X               | Category 05 SW1         | -                | See glossary of terms in appendix B.  | 0377   |
| -      | -                                  | -             | F-B, S-X               | Category 05 SW1         | -                | See glossary of terms in appendix B.  | 0378   |
| -      | -                                  | -             | F-B, S-X               | Category 02 SW1         | -                | See glossary of terms in appendix B.  | 0379   |
| -      | -                                  | -             | F-B, S-X               | Category 05 SW1         | -                | See glossary of terms in appendix B.  | 0380   |
| -      | -                                  | -             | F-B, S-X               | Category 03 SW1         | -                | See glossary of terms in appendix B.  | 0381   |
| -      | -                                  | -             | F-B, S-X               | Category 05 SW1         | -                | See glossary of terms in appendix B.  | 0382   |
| -      | -                                  | -             | F-B, S-X               | Category 05 SW1         | -                | See glossary of terms in appendix B.  | 0383   |
| -      | -                                  | -             | F-B, S-X               | Category 01 SW1         | -                | See glossary of terms in appendix B.  | 0384   |
| -      | -                                  | -             | F-B, S-Y               | Category 04 SW1         | -                | Substance.  | 0385   |
| -      | -                                  | -             | F-B, S-Y               | Category 04 SW1         | SG31             | Substance.  | 0386   |
| -      | -                                  | -             | F-B, S-Y               | Category 04 SW1         | -                | Substance.  | 0387   |
| -      | -                                  | -             | F-B, S-Y               | Category 04 SW1         | -                | Substance.  | 0388   |
| -      | -                                  | -             | F-B, S-Y               | Category 04 SW1         | -                | Substance.  | 0389   |
| -      | -                                  | -             | F-B, S-Y               | Category 04 SW1         | -                | Tritonal is a substance consisting of trinitrotoluene (TNT) mixed with aluminium. | 0390   |

Part 3 – Dangerous Goods List, special provisions and exceptions

Chapter 3.2 – Dangerous Goods List

| UN No. | Proper shipping name (PSN)  | Class or division | Subsidiary hazard(s) | Packing group  | Special provisions | Limited and excepted quantity provisions |                     | Packing              |              | IBC           |               |
|--------|---|-------------------|----------------------|----------------|--------------------|--|---------------------|----------------------|--------------|---------------|---------------|
|        |   |                   |                      |                |                    | Limited quantities                       | Excepted quantities | Instructions         | Provisions   | Instructions  | Provisions    |
| (1)    | (2)<br>3.1.2  | (3)<br>2.0        | (4)<br>2.0           | (5)<br>2.0.1.3 | (6)<br>3.3         | (7a)<br>3.4                              | (7b)<br>3.5         | (8)<br>4.1.4         | (9)<br>4.1.4 | (10)<br>4.1.4 | (11)<br>4.1.4 |
| 0391   | CYCLOTRIMETHYLENE-TRINITRAMINE (CYCLONITE; HEXOGEN; RDX) AND CYCLOTETRAMETHYLENE-TETRANITRAMINE (HMX; OCTOGEN) MIXTURE, WETTED with not less than 15% water, by mass or CYCLOTRIMETHYLENE-TRINITRAMINE (CYCLONITE; HEXOGEN; RDX) AND CYCLOTETRAMETHYLENE-TETRANITRAMINE (HMX; OCTOGEN) MIXTURE, DESENSITIZED with not less than 10% phlegmatizer, by mass | 1.1D              | -                    | -              | 266                | 0  | E0                  | P112 (a) or (b)      | -            | -             | -             |
| 0392   | HEXANITROSTILBENE   | 1.1D              | -                    | -              | -                  | 0  | E0                  | P112 (b) or (c)      | -            | -             | -             |
| 0393   | HEXOTONAL   | 1.1D              | -                    | -              | -                  | 0  | E0                  | P112 (b)             | -            | -             | -             |
| 0394   | TRINITRORESORCINOL (STYPHNIC ACID), WETTED with not less than 20% water, or mixture of alcohol and water, by mass   | 1.1D              | -                    | -              | -                  | 0  | E0                  | P112 (a)             | PP26         | -             | -             |
| 0395   | ROCKET MOTORS, LIQUID FUELLED   | 1.2J              | -                    | -              | -                  | 0  | E0                  | P101                 | -            | -             | -             |
| 0396   | ROCKET MOTORS, LIQUID FUELLED   | 1.3J              | -                    | -              | -                  | 0  | E0                  | P101                 | -            | -             | -             |
| 0397   | ROCKETS, LIQUID FUELLED with bursting charge  | 1.1J              | -                    | -              | -                  | 0  | E0                  | P101                 | -            | -             | -             |
| 0398   | ROCKETS, LIQUID FUELLED with bursting charge  | 1.2J              | -                    | -              | -                  | 0  | E0                  | P101                 | -            | -             | -             |
| 0399   | BOMBS WITH FLAMMABLE LIQUID with bursting charge  | 1.1J              | -                    | -              | -                  | 0  | E0                  | P101                 | -            | -             | -             |
| 0400   | BOMBS WITH FLAMMABLE LIQUID with bursting charge  | 1.2J              | -                    | -              | -                  | 0  | E0                  | P101                 | -            | -             | -             |
| 0401   | DIPICRYL SULPHIDE, dry or wetted with less than 10% water, by mass  | 1.1D              | -                    | -              | -                  | 0  | E0                  | P112 (a), (b) or (c) | -            | -             | -             |
| 0402   | AMMONIUM PERCHLORATE  | 1.1D              | -                    | -              | 152                | 0  | E0                  | P112 (b) or (c)      | -            | -             | -             |
| 0403   | FLARES, AERIAL  | 1.4G              | -                    | -              | -                  | 0  | E0                  | P135                 | -            | -             | -             |
| 0404   | FLARES, AERIAL  | 1.4S              | -                    | -              | -                  | 0  | E0                  | P135                 | -            | -             | -             |
| 0405   | CARTRIDGES, SIGNAL  | 1.4S              | -                    | -              | -                  | 0  | E0                  | P135                 | -            | -             | -             |
| 0406   | DINITROSOBENZENE  | 1.3C              | -                    | -              | -                  | 0  | E0                  | P114 (b)             | -            | -             | -             |
| 0407   | TETRAZOL-1-ACETIC ACID  | 1.4C              | -                    | -              | -                  | 0  | E0                  | P114 (b)             | -            | -             | -             |
| 0408   | FUZES, DETONATING with protective features  | 1.1D              | -                    | -              | -                  | 0  | E0                  | P141                 | -            | -             | -             |
| 0409   | FUZES, DETONATING with protective features  | 1.2D              | -                    | -              | -                  | 0  | E0                  | P141                 | -            | -             | -             |

| UN No. | Portable tanks and bulk containers |               | EmS                    | Stowage and handling    | Segregation      | Properties and observations   | UN No. |
|--------|------------------------------------|---------------|------------------------|-------------------------|------------------|---|--------|
|        | Tank instructions                  | Provisions    |                        |                         |                  |   |        |
| (12)   | (13)<br>4.2.5<br>4.3               | (14)<br>4.2.5 | (15)<br>5.4.3.4<br>7.8 | (16a)<br>7.1<br>7.3-7.7 | (16b)<br>7.2-7.7 | (17)  | (18)   |
| -      | -                                  | -             | F-B, S-Y               | Category 04 SW1         | -                | Substance. Mass detonating explosive which will become more sensitive if the wetting or desensitizing agents are lost. This substance, when containing less alcohol, water or phlegmatizer than specified, shall not be transported, unless specifically authorized by the competent authority. | 0391   |
| -      | -                                  | -             | F-B, S-Y               | Category 04 SW1         | -                | Substance. Mass detonating explosive.   | 0392   |
| -      | -                                  | -             | F-B, S-Y               | Category 04 SW1         | -                | Substance. Mass detonating explosive.   | 0393   |
| -      | -                                  | -             | F-B, S-Y               | Category 04 SW1         | SG31             | Substance. Mass detonating explosive.   | 0394   |
| -      | -                                  | -             | F-B, S-X               | Category 05 SW1         | SG67             | See glossary of terms in appendix B.  | 0395   |
| -      | -                                  | -             | F-B, S-X               | Category 05 SW1         | SG67             | See glossary of terms in appendix B.  | 0396   |
| -      | -                                  | -             | F-B, S-X               | Category 05 SW1         | SG67             | See glossary of terms in appendix B.  | 0397   |
| -      | -                                  | -             | F-B, S-X               | Category 05 SW1         | SG67             | See glossary of terms in appendix B.  | 0398   |
| -      | -                                  | -             | F-B, S-X               | Category 05 SW1         | SG67             | See glossary of terms in appendix B.  | 0399   |
| -      | -                                  | -             | F-B, S-X               | Category 05 SW1         | SG67             | See glossary of terms in appendix B.  | 0400   |
| -      | -                                  | -             | F-B, S-Y               | Category 04 SW1         | -                | Substance.  | 0401   |
| -      | -                                  | -             | F-B, S-Y               | Category 04 SW1         | SGG2<br>SG27     | Substance.  | 0402   |
| -      | -                                  | -             | F-B, S-X               | Category 02 SW1         | -                | See glossary of terms in appendix B.  | 0403   |
| -      | -                                  | -             | F-B, S-X               | Category 01 SW1         | -                | See glossary of terms in appendix B.  | 0404   |
| -      | -                                  | -             | F-B, S-X               | Category 01 SW1         | -                | See glossary of terms in appendix B.  | 0405   |
| -      | -                                  | -             | F-B, S-Y               | Category 04 SW1         | -                | Substance.  | 0406   |
| -      | -                                  | -             | F-B, S-Y               | Category 02 SW1         | -                | Substance.  | 0407   |
| -      | -                                  | -             | F-B, S-X               | Category 03 SW1         | -                | See glossary of terms in appendix B.  | 0408   |
| -      | -                                  | -             | F-B, S-X               | Category 03 SW1         | -                | See glossary of terms in appendix B.  | 0409   |

Part 3 – Dangerous Goods List, special provisions and exceptions

Chapter 3.2 – Dangerous Goods List

| UN No. | Proper shipping name (PSN)  | Class or division | Subsidiary hazard(s) | Packing group  | Special provisions | Limited and excepted quantity provisions |                     | Packing         |              | IBC           |               |
|--------|---|-------------------|----------------------|----------------|--------------------|--|---------------------|-----------------|--------------|---------------|---------------|
|        |   |                   |                      |                |                    | Limited quantities                       | Excepted quantities | Instructions    | Provisions   | Instructions  | Provisions    |
| (1)    | (2)<br>3.1.2  | (3)<br>2.0        | (4)<br>2.0           | (5)<br>2.0.1.3 | (6)<br>3.3         | (7a)<br>3.4                              | (7b)<br>3.5         | (8)<br>4.1.4    | (9)<br>4.1.4 | (10)<br>4.1.4 | (11)<br>4.1.4 |
| 0410   | FUZES, DETONATING with protective features  | 1.4D              | -                    | -              | -                  | 0  | E0                  | P141            | -            | -             | -             |
| 0411   | PENTAERYTHRITE TETRANITRATE (PENTAERYTHRITOL TETRANITRATE; PETN) with not less than 7% wax, by mass | 1.1D              | -                    | -              | 131                | 0  | E0                  | P112 (b) or (c) | -            | -             | -             |
| 0412   | CARTRIDGES FOR WEAPONS with bursting charge   | 1.4E              | -                    | -              | -                  | 0  | E0                  | P130 LP101      | PP67 L1      | -             | -             |
| 0413   | CARTRIDGES FOR WEAPONS, BLANK   | 1.2C              | -                    | -              | -                  | 0  | E0                  | P130 LP101      | -            | -             | -             |
| 0414   | CHARGES, PROPELLING, FOR CANNON   | 1.2C              | -                    | -              | -                  | 0  | E0                  | P130 LP101      | -            | -             | -             |
| 0415   | CHARGES, PROPELLING   | 1.2C              | -                    | -              | -                  | 0  | E0                  | P143            | PP76         | -             | -             |
| 0417   | CARTRIDGES FOR WEAPONS, INERT PROJECTILE or CARTRIDGES, SMALL ARMS                                  | 1.3C              | -                    | -              | -                  | 0  | E0                  | P130 LP101      | -            | -             | -             |
| 0418   | FLARES, SURFACE   | 1.1G              | -                    | -              | -                  | 0  | E0                  | P135            | -            | -             | -             |
| 0419   | FLARES, SURFACE   | 1.2G              | -                    | -              | -                  | 0  | E0                  | P135            | -            | -             | -             |
| 0420   | FLARES, AERIAL  | 1.1G              | -                    | -              | -                  | 0  | E0                  | P135            | -            | -             | -             |
| 0421   | FLARES, AERIAL  | 1.2G              | -                    | -              | -                  | 0  | E0                  | P135            | -            | -             | -             |
| 0424   | PROJECTILES, inert with tracer  | 1.3G              | -                    | -              | -                  | 0  | E0                  | P130 LP101      | PP67 L1      | -             | -             |
| 0425   | PROJECTILES, inert with tracer  | 1.4G              | -                    | -              | -                  | 0  | E0                  | P130 LP101      | PP67 L1      | -             | -             |
| 0426   | PROJECTILES with burster or expelling charge  | 1.2F              | -                    | -              | -                  | 0  | E0                  | P130 LP101      | -            | -             | -             |
| 0427   | PROJECTILES with burster or expelling charge  | 1.4F              | -                    | -              | -                  | 0  | E0                  | P130 LP101      | -            | -             | -             |
| 0428   | ARTICLES, PYROTECHNIC for technical purposes  | 1.1G              | -                    | -              | -                  | 0  | E0                  | P135            | -            | -             | -             |
| 0429   | ARTICLES, PYROTECHNIC for technical purposes  | 1.2G              | -                    | -              | -                  | 0  | E0                  | P135            | -            | -             | -             |
| 0430   | ARTICLES, PYROTECHNIC for technical purposes  | 1.3G              | -                    | -              | -                  | 0  | E0                  | P135            | -            | -             | -             |
| 0431   | ARTICLES, PYROTECHNIC for technical purposes  | 1.4G              | -                    | -              | -                  | 0  | E0                  | P135            | -            | -             | -             |
| 0432   | ARTICLES, PYROTECHNIC for technical purposes  | 1.4S              | -                    | -              | -                  | 0  | E0                  | P135            | -            | -             | -             |
| 0433   | POWDER CAKE (POWDER PASTE), WETTED with not less than 17% alcohol, by mass                          | 1.1C              | -                    | -              | 266                | 0  | E0                  | P111            | -            | -             | -             |
| 0434   | PROJECTILES with burster or expelling charge  | 1.2G              | -                    | -              | -                  | 0  | E0                  | P130 LP101      | PP67 L1      | -             | -             |
| 0435   | PROJECTILES with burster or expelling charge  | 1.4G              | -                    | -              | -                  | 0  | E0                  | P130 LP101      | PP67 L1      | -             | -             |
| 0436   | ROCKETS with expelling charge   | 1.2C              | -                    | -              | -                  | 0  | E0                  | P130 LP101      | PP67 L1      | -             | -             |

| UN No. | Portable tanks and bulk containers |               | EmS                    | Stowage and handling    | Segregation      | Properties and observations          | UN No. |
|--------|------------------------------------|---------------|------------------------|-------------------------|------------------|--------------------------------------|--------|
|        | Tank instructions                  | Provisions    |                        |                         |                  |                                      |        |
| (12)   | (13)<br>4.2.5<br>4.3               | (14)<br>4.2.5 | (15)<br>5.4.3.4<br>7.8 | (16a)<br>7.1<br>7.3-7.7 | (16b)<br>7.2-7.7 | (17)                                 | (18)   |
| -      | -                                  | -             | F-B, S-X               | Category 02 SW1         | -                | See glossary of terms in appendix B. | 0410   |
| -      | -                                  | -             | F-B, S-Y               | Category 04 SW1         | -                | Substance.                           | 0411   |
| -      | -                                  | -             | F-B, S-X               | Category 03 SW1         | -                | See glossary of terms in appendix B. | 0412   |
| -      | -                                  | -             | F-B, S-X               | Category 03 SW1         | -                | See glossary of terms in appendix B. | 0413   |
| -      | -                                  | -             | F-B, S-X               | Category 03 SW1         | -                | See glossary of terms in appendix B. | 0414   |
| -      | -                                  | -             | F-B, S-X               | Category 03 SW1         | -                | See glossary of terms in appendix B. | 0415   |
| -      | -                                  | -             | F-B, S-X               | Category 03 SW1         | -                | See glossary of terms in appendix B. | 0417   |
| -      | -                                  | -             | F-B, S-X               | Category 03 SW1         | -                | See glossary of terms in appendix B. | 0418   |
| -      | -                                  | -             | F-B, S-X               | Category 03 SW1         | -                | See glossary of terms in appendix B. | 0419   |
| -      | -                                  | -             | F-B, S-X               | Category 03 SW1         | -                | See glossary of terms in appendix B. | 0420   |
| -      | -                                  | -             | F-B, S-X               | Category 03 SW1         | -                | See glossary of terms in appendix B. | 0421   |
| -      | -                                  | -             | F-B, S-X               | Category 03 SW1         | -                | See glossary of terms in appendix B. | 0424   |
| -      | -                                  | -             | F-B, S-X               | Category 02 SW1         | -                | See glossary of terms in appendix B. | 0425   |
| -      | -                                  | -             | F-B, S-X               | Category 03 SW1         | -                | See glossary of terms in appendix B. | 0426   |
| -      | -                                  | -             | F-B, S-X               | Category 03 SW1         | -                | See glossary of terms in appendix B. | 0427   |
| -      | -                                  | -             | F-B, S-X               | Category 03 SW1         | -                | See glossary of terms in appendix B. | 0428   |
| -      | -                                  | -             | F-B, S-X               | Category 03 SW1         | -                | See glossary of terms in appendix B. | 0429   |
| -      | -                                  | -             | F-B, S-X               | Category 03 SW1         | -                | See glossary of terms in appendix B. | 0430   |
| -      | -                                  | -             | F-B, S-X               | Category 02 SW1         | -                | See glossary of terms in appendix B. | 0431   |
| -      | -                                  | -             | F-B, S-X               | Category 01 SW1         | -                | See glossary of terms in appendix B. | 0432   |
| -      | -                                  | -             | F-B, S-Y               | Category 04 SW1         | -                | See glossary of terms in appendix B. | 0433   |
| -      | -                                  | -             | F-B, S-X               | Category 03 SW1         | -                | See glossary of terms in appendix B. | 0434   |
| -      | -                                  | -             | F-B, S-X               | Category 02 SW1         | -                | See glossary of terms in appendix B. | 0435   |
| -      | -                                  | -             | F-B, S-X               | Category 03 SW1         | -                | See glossary of terms in appendix B. | 0436   |



Part 3 – Dangerous Goods List, special provisions and exceptions

Chapter 3.2 – Dangerous Goods List

| UN No. | Proper shipping name (PSN)                                | Class or division | Subsidiary hazard(s) | Packing group  | Special provisions | Limited and excepted quantity provisions |                     | Packing      |              | IBC           |               |
|--------|---|-------------------|----------------------|----------------|--------------------|--|---------------------|--------------|--------------|---------------|---------------|
|        |   |                   |                      |                |                    | Limited quantities                       | Excepted quantities | Instructions | Provisions   | Instructions  | Provisions    |
| (1)    | (2)<br>3.1.2  | (3)<br>2.0        | (4)<br>2.0           | (5)<br>2.0.1.3 | (6)<br>3.3         | (7a)<br>3.4                              | (7b)<br>3.5         | (8)<br>4.1.4 | (9)<br>4.1.4 | (10)<br>4.1.4 | (11)<br>4.1.4 |
| 0437   | ROCKETS with expelling charge                             | 1.3C              | -                    | -              | -                  | 0  | E0                  | P130 LP101   | PP67 L1      | -             | -             |
| 0438   | ROCKETS with expelling charge                             | 1.4C              | -                    | -              | -                  | 0  | E0                  | P130 LP101   | PP67 L1      | -             | -             |
| 0439   | CHARGES, SHAPED, without detonator                        | 1.2D              | -                    | -              | -                  | 0  | E0                  | P137         | PP70         | -             | -             |
| 0440   | CHARGES, SHAPED, without detonator                        | 1.4D              | -                    | -              | -                  | 0  | E0                  | P137         | PP70         | -             | -             |
| 0441   | CHARGES, SHAPED, without detonator                        | 1.4S              | -                    | -              | 347                | 0  | E0                  | P137         | PP70         | -             | -             |
| 0442   | CHARGES, EXPLOSIVE, COMMERCIAL without detonator          | 1.1D              | -                    | -              | -                  | 0  | E0                  | P137         | -            | -             | -             |
| 0443   | CHARGES, EXPLOSIVE, COMMERCIAL without detonator          | 1.2D              | -                    | -              | -                  | 0  | E0                  | P137         | -            | -             | -             |
| 0444   | CHARGES, EXPLOSIVE, COMMERCIAL without detonator          | 1.4D              | -                    | -              | -                  | 0  | E0                  | P137         | -            | -             | -             |
| 0445   | CHARGES, EXPLOSIVE, COMMERCIAL without detonator          | 1.4S              | -                    | -              | 347                | 0  | E0                  | P137         | -            | -             | -             |
| 0446   | CASES, COMBUSTIBLE, EMPTY, WITHOUT PRIMER                 | 1.4C              | -                    | -              | -                  | 0  | E0                  | P136         | -            | -             | -             |
| 0447   | CASES, COMBUSTIBLE, EMPTY, WITHOUT PRIMER                 | 1.3C              | -                    | -              | -                  | 0  | E0                  | P136         | -            | -             | -             |
| 0448   | 5-MERCAPTOTETRAZOL-1-ACETIC ACID                          | 1.4C              | -                    | -              | -                  | 0  | E0                  | P114 (b)     | -            | -             | -             |
| 0449   | TORPEDOES, LIQUID FUELLED with or without bursting charge | 1.1J              | -                    | -              | -                  | 0  | E0                  | P101         | -            | -             | -             |
| 0450   | TORPEDOES, LIQUID FUELLED with inert head                 | 1.3J              | -                    | -              | -                  | 0  | E0                  | P101         | -            | -             | -             |
| 0451   | TORPEDOES with bursting charge                            | 1.1D              | -                    | -              | -                  | 0  | E0                  | P130 LP101   | PP67 L1      | -             | -             |
| 0452   | GRENADES, PRACTICE, hand or rifle                         | 1.4G              | -                    | -              | -                  | 0  | E0                  | P141         | -            | -             | -             |
| 0453   | ROCKETS, LINE-THROWING                                    | 1.4G              | -                    | -              | -                  | 0  | E0                  | P130 LP101   | -            | -             | -             |
| 0454   | IGNITERS  | 1.4S              | -                    | -              | -                  | 0  | E0                  | P142         | -            | -             | -             |
| 0455   | DETONATORS, NON-ELECTRIC for blasting                     | 1.4S              | -                    | -              | 347                | 0  | E0                  | P131         | PP68         | -             | -             |
| 0456   | DETONATORS, ELECTRIC for blasting                         | 1.4S              | -                    | -              | 347 399            | 0  | E0                  | P131         | -            | -             | -             |
| 0457   | CHARGES, BURSTING, PLASTICS BONDED                        | 1.1D              | -                    | -              | -                  | 0  | E0                  | P130 LP101   | -            | -             | -             |
| 0458   | CHARGES, BURSTING, PLASTICS BONDED                        | 1.2D              | -                    | -              | -                  | 0  | E0                  | P130 LP101   | -            | -             | -             |
| 0459   | CHARGES, BURSTING, PLASTICS BONDED                        | 1.4D              | -                    | -              | -                  | 0  | E0                  | P130 LP101   | -            | -             | -             |
| 0460   | CHARGES, BURSTING, PLASTICS BONDED                        | 1.4S              | -                    | -              | 347                | 0  | E0                  | P130 LP101   | -            | -             | -             |
| 0461   | COMPONENTS, EXPLOSIVE TRAIN, N.O.S.                       | 1.1B              | -                    | -              | 178 274            | 0  | E0                  | P101         | -            | -             | -             |
| 0462   | ARTICLES, EXPLOSIVE, N.O.S.                               | 1.1C              | -                    | -              | 178 274            | 0  | E0                  | P101         | -            | -             | -             |

| UN No. | Portable tanks and bulk containers |               | EmS                    | Stowage and handling    | Segregation      | Properties and observations          | UN No. |
|--------|------------------------------------|---------------|------------------------|-------------------------|------------------|--------------------------------------|--------|
|        | Tank instructions                  | Provisions    |                        |                         |                  |                                      |        |
| (12)   | (13)<br>4.2.5<br>4.3               | (14)<br>4.2.5 | (15)<br>5.4.3.4<br>7.8 | (16a)<br>7.1<br>7.3-7.7 | (16b)<br>7.2-7.7 | (17)                                 | (18)   |
| -      | -                                  | -             | F-B, S-X               | Category 03 SW1         | -                | See glossary of terms in appendix B. | 0437   |
| -      | -                                  | -             | F-B, S-X               | Category 02 SW1         | -                | See glossary of terms in appendix B. | 0438   |
| -      | -                                  | -             | F-B, S-X               | Category 03 SW1         | -                | See glossary of terms in appendix B. | 0439   |
| -      | -                                  | -             | F-B, S-X               | Category 02 SW1         | -                | See glossary of terms in appendix B. | 0440   |
| -      | -                                  | -             | F-B, S-X               | Category 01 SW1         | -                | See glossary of terms in appendix B. | 0441   |
| -      | -                                  | -             | F-B, S-X               | Category 03 SW1         | -                | See glossary of terms in appendix B. | 0442   |
| -      | -                                  | -             | F-B, S-X               | Category 03 SW1         | -                | See glossary of terms in appendix B. | 0443   |
| -      | -                                  | -             | F-B, S-X               | Category 02 SW1         | -                | See glossary of terms in appendix B. | 0444   |
| -      | -                                  | -             | F-B, S-X               | Category 01 SW1         | -                | See glossary of terms in appendix B. | 0445   |
| -      | -                                  | -             | F-B, S-X               | Category 02 SW1         | -                | See glossary of terms in appendix B. | 0446   |
| -      | -                                  | -             | F-B, S-X               | Category 03 SW1         | -                | See glossary of terms in appendix B. | 0447   |
| -      | -                                  | -             | F-B, S-Y               | Category 02 SW1         | -                | Substance.                           | 0448   |
| -      | -                                  | -             | F-B, S-X               | Category 05 SW1         | SG67             | See glossary of terms in appendix B. | 0449   |
| -      | -                                  | -             | F-B, S-X               | Category 05 SW1         | SG67             | See glossary of terms in appendix B. | 0450   |
| -      | -                                  | -             | F-B, S-X               | Category 03 SW1         | -                | See glossary of terms in appendix B. | 0451   |
| -      | -                                  | -             | F-B, S-X               | Category 02 SW1         | -                | See glossary of terms in appendix B. | 0452   |
| -      | -                                  | -             | F-B, S-X               | Category 02 SW1         | -                | See glossary of terms in appendix B. | 0453   |
| -      | -                                  | -             | F-B, S-X               | Category 01 SW1         | -                | See glossary of terms in appendix B. | 0454   |
| -      | -                                  | -             | F-B, S-X               | Category 01 SW1         | -                | See glossary of terms in appendix B. | 0455   |
| -      | -                                  | -             | F-B, S-X               | Category 01 SW1         | -                | See glossary of terms in appendix B. | 0456   |
| -      | -                                  | -             | F-B, S-X               | Category 03 SW1         | -                | See glossary of terms in appendix B. | 0457   |
| -      | -                                  | -             | F-B, S-X               | Category 03 SW1         | -                | See glossary of terms in appendix B. | 0458   |
| -      | -                                  | -             | F-B, S-X               | Category 02 SW1         | -                | See glossary of terms in appendix B. | 0459   |
| -      | -                                  | -             | F-B, S-X               | Category 01 SW1         | -                | See glossary of terms in appendix B. | 0460   |
| -      | -                                  | -             | F-B, S-X               | Category 05 SW1         | -                | See glossary of terms in appendix B. | 0461   |
| -      | -                                  | -             | F-B, S-X               | Category 03 SW1         | -                | -                                    | 0462   |

Part 3 – Dangerous Goods List, special provisions and exceptions

Chapter 3.2 – Dangerous Goods List

| UN No. | Proper shipping name (PSN)   | Class or division | Subsidiary hazard(s) | Packing group  | Special provisions | Limited and excepted quantity provisions |                     | Packing         |              | IBC           |               |
|--------|--|-------------------|----------------------|----------------|--------------------|--|---------------------|-----------------|--------------|---------------|---------------|
|        |  |                   |                      |                |                    | Limited quantities                       | Excepted quantities | Instructions    | Provisions   | Instructions  | Provisions    |
| (1)    | (2)<br>3.1.2   | (3)<br>2.0        | (4)<br>2.0           | (5)<br>2.0.1.3 | (6)<br>3.3         | (7a)<br>3.4                              | (7b)<br>3.5         | (8)<br>4.1.4    | (9)<br>4.1.4 | (10)<br>4.1.4 | (11)<br>4.1.4 |
| 0463   | ARTICLES, EXPLOSIVE, N.O.S.  | 1.1D              | -                    | -              | 178<br>274         | 0  | E0                  | P101            | -            | -             | -             |
| 0464   | ARTICLES, EXPLOSIVE, N.O.S.  | 1.1E              | -                    | -              | 178<br>274         | 0  | E0                  | P101            | -            | -             | -             |
| 0465   | ARTICLES, EXPLOSIVE, N.O.S.  | 1.1F              | -                    | -              | 178<br>274         | 0  | E0                  | P101            | -            | -             | -             |
| 0466   | ARTICLES, EXPLOSIVE, N.O.S.  | 1.2C              | -                    | -              | 178<br>274         | 0  | E0                  | P101            | -            | -             | -             |
| 0467   | ARTICLES, EXPLOSIVE, N.O.S.  | 1.2D              | -                    | -              | 178<br>274         | 0  | E0                  | P101            | -            | -             | -             |
| 0468   | ARTICLES, EXPLOSIVE, N.O.S.  | 1.2E              | -                    | -              | 178<br>274         | 0  | E0                  | P101            | -            | -             | -             |
| 0469   | ARTICLES, EXPLOSIVE, N.O.S.  | 1.2F              | -                    | -              | 178<br>274         | 0  | E0                  | P101            | -            | -             | -             |
| 0470   | ARTICLES, EXPLOSIVE, N.O.S.  | 1.3C              | -                    | -              | 178<br>274         | 0  | E0                  | P101            | -            | -             | -             |
| 0471   | ARTICLES, EXPLOSIVE, N.O.S.  | 1.4E              | -                    | -              | 178<br>274         | 0  | E0                  | P101            | -            | -             | -             |
| 0472   | ARTICLES, EXPLOSIVE, N.O.S.  | 1.4F              | -                    | -              | 178<br>274         | 0  | E0                  | P101            | -            | -             | -             |
| 0473   | SUBSTANCES, EXPLOSIVE, N.O.S.  | 1.1A              | -                    | -              | 178<br>274         | 0  | E0                  | P101            | -            | -             | -             |
| 0474   | SUBSTANCES, EXPLOSIVE, N.O.S.  | 1.1C              | -                    | -              | 178<br>274         | 0  | E0                  | P101            | -            | -             | -             |
| 0475   | SUBSTANCES, EXPLOSIVE, N.O.S.  | 1.1D              | -                    | -              | 178<br>274         | 0  | E0                  | P101            | -            | -             | -             |
| 0476   | SUBSTANCES, EXPLOSIVE, N.O.S.  | 1.1G              | -                    | -              | 178<br>274         | 0  | E0                  | P101            | -            | -             | -             |
| 0477   | SUBSTANCES, EXPLOSIVE, N.O.S.  | 1.3C              | -                    | -              | 178<br>274         | 0  | E0                  | P101            | -            | -             | -             |
| 0478   | SUBSTANCES, EXPLOSIVE, N.O.S.  | 1.3G              | -                    | -              | 178<br>274         | 0  | E0                  | P101            | -            | -             | -             |
| 0479   | SUBSTANCES, EXPLOSIVE, N.O.S.  | 1.4C              | -                    | -              | 178<br>274         | 0  | E0                  | P101            | -            | -             | -             |
| 0480   | SUBSTANCES, EXPLOSIVE, N.O.S.  | 1.4D              | -                    | -              | 178<br>274         | 0  | E0                  | P101            | -            | -             | -             |
| 0481   | SUBSTANCES, EXPLOSIVE, N.O.S.  | 1.4S              | -                    | -              | 178<br>274<br>347  | 0  | E0                  | P101            | -            | -             | -             |
| 0482   | SUBSTANCES, EXPLOSIVE, VERY INSENSITIVE (SUBSTANCES, EVI), N.O.S.      | 1.5D              | -                    | -              | 178<br>274         | 0  | E0                  | P101            | -            | -             | -             |
| 0483   | CYCLOTRIMETHYLENE-TRINITRAMINE (CYCLONITE; HEXOGEN; RDX), DESENSITIZED | 1.1D              | -                    | -              | -                  | 0  | E0                  | P112 (b) or (c) | -            | -             | -             |
| 0484   | CYCLOTETRAMETHYLENE-TETRAMINE (HMX; OCTOGEN), DESENSITIZED             | 1.1D              | -                    | -              | -                  | 0  | E0                  | P112 (b) or (c) | -            | -             | -             |
| 0485   | SUBSTANCES, EXPLOSIVE, N.O.S.  | 1.4G              | -                    | -              | 178<br>274         | 0  | E0                  | P101            | -            | -             | -             |
| 0486   | ARTICLES, EXPLOSIVE, EXTREMELY INSENSITIVE (ARTICLES, EEI)             | 1.6N              | -                    | -              | -                  | 0  | E0                  | P101            | -            | -             | -             |

| UN No. | Portable tanks and bulk containers |               | EmS                    | Stowage and handling    | Segregation      | Properties and observations  | UN No. |
|--------|------------------------------------|---------------|------------------------|-------------------------|------------------|--|--------|
|        | Tank instructions                  | Provisions    |                        |                         |                  |  |        |
| (12)   | (13)<br>4.2.5<br>4.3               | (14)<br>4.2.5 | (15)<br>5.4.3.4<br>7.8 | (16a)<br>7.1<br>7.3-7.7 | (16b)<br>7.2-7.7 | (17)   | (18)   |
| -      | -                                  | -             | F-B, S-X               | Category 03 SW1         | -                | -  | 0463   |
| -      | -                                  | -             | F-B, S-X               | Category 03 SW1         | -                | -  | 0464   |
| -      | -                                  | -             | F-B, S-X               | Category 03 SW1         | -                | -  | 0465   |
| -      | -                                  | -             | F-B, S-X               | Category 03 SW1         | -                | -  | 0466   |
| -      | -                                  | -             | F-B, S-X               | Category 03 SW1         | -                | -  | 0467   |
| -      | -                                  | -             | F-B, S-X               | Category 03 SW1         | -                | -  | 0468   |
| -      | -                                  | -             | F-B, S-X               | Category 03 SW1         | -                | -  | 0469   |
| -      | -                                  | -             | F-B, S-X               | Category 03 SW1         | -                | -  | 0470   |
| -      | -                                  | -             | F-B, S-X               | Category 03 SW1         | -                | -  | 0471   |
| -      | -                                  | -             | F-B, S-X               | Category 03 SW1         | -                | -  | 0472   |
| -      | -                                  | -             | F-B, S-Y               | Category 05 SW1         | -                | -  | 0473   |
| -      | -                                  | -             | F-B, S-Y               | Category 04 SW1         | -                | -  | 0474   |
| -      | -                                  | -             | F-B, S-Y               | Category 04 SW1         | -                | -  | 0475   |
| -      | -                                  | -             | F-B, S-Y               | Category 03 SW1         | -                | -  | 0476   |
| -      | -                                  | -             | F-B, S-Y               | Category 04 SW1         | -                | -  | 0477   |
| -      | -                                  | -             | F-B, S-Y               | Category 03 SW1         | -                | -  | 0478   |
| -      | -                                  | -             | F-B, S-Y               | Category 02 SW1         | -                | -  | 0479   |
| -      | -                                  | -             | F-B, S-Y               | Category 02 SW1         | -                | -  | 0480   |
| -      | -                                  | -             | F-B, S-Y               | Category 01 SW1         | -                | -  | 0481   |
| -      | -                                  | -             | F-B, S-Y               | Category 03 SW1         | -                | -  | 0482   |
| -      | -                                  | -             | F-B, S-Y               | Category 04 SW1         | -                | Substance. Mass detonating explosive which will become more sensitive if the wetting or desensitizing agents are lost. | 0483   |
| -      | -                                  | -             | F-B, S-Y               | Category 04 SW1         | -                | Substance. Mass detonating explosive which will become more sensitive if the wetting or desensitizing agents are lost. | 0484   |
| -      | -                                  | -             | F-B, S-Y               | Category 02 SW1         | -                | -  | 0485   |
| -      | -                                  | -             | F-B, S-X               | Category 03 SW1         | -                | See glossary of terms in appendix B.   | 0486   |



Part 3 – Dangerous Goods List, special provisions and exceptions

Chapter 3.2 – Dangerous Goods List

| UN No. | Proper shipping name (PSN)   | Class or division | Subsidiary hazard(s) | Packing group  | Special provisions | Limited and excepted quantity provisions |                     | Packing         |                     | IBC           |               |
|--------|--|-------------------|----------------------|----------------|--------------------|--|---------------------|-----------------|---------------------|---------------|---------------|
|        |  |                   |                      |                |                    | Limited quantities                       | Excepted quantities | Instructions    | Provisions          | Instructions  | Provisions    |
| (1)    | (2)<br>3.1.2   | (3)<br>2.0        | (4)<br>2.0           | (5)<br>2.0.1.3 | (6)<br>3.3         | (7a)<br>3.4                              | (7b)<br>3.5         | (8)<br>4.1.4    | (9)<br>4.1.4        | (10)<br>4.1.4 | (11)<br>4.1.4 |
| 0487   | SIGNALS, SMOKE   | 1.3G              | -                    | -              | -                  | 0  | E0                  | P135            | -                   | -             | -             |
| 0488   | AMMUNITION, PRACTICE   | 1.3G              | -                    | -              | -                  | 0  | E0                  | P130 LP101      | PP67 L1             | -             | -             |
| 0489   | DINITROGLYCOLURIL (DINGU)  | 1.1D              | -                    | -              | -                  | 0  | E0                  | P112 (b) or (c) | -                   | -             | -             |
| 0490   | NITROTRIAZOLONE (NTO)  | 1.1D              | -                    | -              | -                  | 0  | E0                  | P112 (b) or (c) | -                   | -             | -             |
| 0491   | CHARGES, PROPELLING  | 1.4C              | -                    | -              | -                  | 0  | E0                  | P143            | PP76                | -             | -             |
| 0492   | SIGNALS, RAILWAY TRACK, EXPLOSIVE  | 1.3G              | -                    | -              | -                  | 0  | E0                  | P135            | -                   | -             | -             |
| 0493   | SIGNALS, RAILWAY TRACK, EXPLOSIVE  | 1.4G              | -                    | -              | -                  | 0  | E0                  | P135            | -                   | -             | -             |
| 0494   | JET PERFORATING GUNS, CHARGED, oil well, without detonator                         | 1.4D              | -                    | -              | -                  | 0  | E0                  | P101            | -                   | -             | -             |
| 0495   | PROPELLANT, LIQUID   | 1.3C              | -                    | -              | 224                | 0  | E0                  | P115            | PP53 PP54 PP57 PP58 | -             | -             |
| 0496   | OCTONAL  | 1.1D              | -                    | -              | -                  | 0  | E0                  | P112 (b) or (c) | -                   | -             | -             |
| 0497   | PROPELLANT, LIQUID   | 1.1C              | -                    | -              | 224                | 0  | E0                  | P115            | PP53 PP54 PP57 PP58 | -             | -             |
| 0498   | PROPELLANT, SOLID  | 1.1C              | -                    | -              | -                  | 0  | E0                  | P114 (b)        | -                   | -             | -             |
| 0499   | PROPELLANT, SOLID  | 1.3C              | -                    | -              | -                  | 0  | E0                  | P114 (b)        | -                   | -             | -             |
| 0500   | DETONATOR ASSEMBLIES, NON-ELECTRIC for blasting                                    | 1.4S              | -                    | -              | 347                | 0  | E0                  | P131            | -                   | -             | -             |
| 0501   | PROPELLANT, SOLID  | 1.4C              | -                    | -              | -                  | 0  | E0                  | P114 (b)        | -                   | -             | -             |
| 0502   | ROCKETS with inert head  | 1.2C              | -                    | -              | -                  | 0  | E0                  | P130 LP101      | PP67 L1             | -             | -             |
| 0503   | SAFETY DEVICES, PYROTECHNIC  | 1.4G              | -                    | -              | 235 289            | 0  | E0                  | P135            | -                   | -             | -             |
| 0504   | 1H-TETRAZOLE   | 1.1D              | -                    | -              | -                  | 0  | E0                  | P112 (c)        | PP48                | -             | -             |
| 0505   | SIGNALS, DISTRESS, ship  | 1.4G              | -                    | -              | -                  | 0  | E0                  | P135            | -                   | -             | -             |
| 0506   | SIGNALS, DISTRESS, ship  | 1.4S              | -                    | -              | -                  | 0  | E0                  | P135            | -                   | -             | -             |
| 0507   | SIGNALS, SMOKE   | 1.4S              | -                    | -              | -                  | 0  | E0                  | P135            | -                   | -             | -             |
| 0508   | 1-HYDROXYBENZOTRIAZOLE, ANHYDROUS, dry or wetted with less than 20% water, by mass | 1.3C              | -                    | -              | -                  | 0  | E0                  | P114 (b)        | PP48 PP50           | -             | -             |
| 0509   | POWDER, SMOKELESS  | 1.4C              | -                    | -              | -                  | 0  | E0                  | P114(b)         | PP48                | -             | -             |
| 0510   | ROCKET MOTORS  | 1.4C              | -                    | -              | -                  | 0  | E0                  | P130 LP101      | PP67 L1             | -             | -             |

| UN No. | Portable tanks and bulk containers |               | EmS                    | Stowage and handling    | Segregation      | Properties and observations                        | UN No. |
|--------|------------------------------------|---------------|------------------------|-------------------------|------------------|--|--------|
|        | Tank instructions                  | Provisions    |                        |                         |                  |  |        |
| (12)   | (13)<br>4.2.5<br>4.3               | (14)<br>4.2.5 | (15)<br>5.4.3.4<br>7.8 | (16a)<br>7.1<br>7.3-7.7 | (16b)<br>7.2-7.7 | (17)   | (18)   |
| -      | -                                  | -             | F-B, S-X               | Category 03 SW1         | -                | See glossary of terms in appendix B.               | 0487   |
| -      | -                                  | -             | F-B, S-X               | Category 03 SW1         | -                | See glossary of terms in appendix B.               | 0488   |
| -      | -                                  | -             | F-B, S-Y               | Category 04 SW1         | -                | Substance.   | 0489   |
| -      | -                                  | -             | F-B, S-Y               | Category 04 SW1         | -                | Substance.   | 0490   |
| -      | -                                  | -             | F-B, S-X               | Category 02 SW1         | -                | See glossary of terms in appendix B.               | 0491   |
| -      | -                                  | -             | F-B, S-X               | Category 03 SW1         | -                | See glossary of terms in appendix B.               | 0492   |
| -      | -                                  | -             | F-B, S-X               | Category 02 SW1         | -                | See glossary of terms in appendix B.               | 0493   |
| -      | -                                  | -             | F-B, S-X               | Category 02 SW1 SW30    | -                | See glossary of terms in appendix B.               | 0494   |
| -      | -                                  | -             | F-B, S-Y               | Category 04 SW1         | -                | See glossary of terms in appendix B.               | 0495   |
| -      | -                                  | -             | F-B, S-Y               | Category 04 SW1         | -                | Substance. Mixtures of mass detonating explosives. | 0496   |
| -      | -                                  | -             | F-B, S-Y               | Category 04 SW1         | -                | See glossary of terms in appendix B.               | 0497   |
| -      | -                                  | -             | F-B, S-Y               | Category 04 SW1         | -                | See glossary of terms in appendix B.               | 0498   |
| -      | -                                  | -             | F-B, S-Y               | Category 04 SW1         | -                | See glossary of terms in appendix B.               | 0499   |
| -      | -                                  | -             | F-B, S-X               | Category 01 SW1         | -                | See glossary of terms in appendix B.               | 0500   |
| -      | -                                  | -             | F-B, S-Y               | Category 02 SW1         | -                | See glossary of terms in appendix B.               | 0501   |
| -      | -                                  | -             | F-B, S-X               | Category 03 SW1         | -                | See glossary of terms in appendix B.               | 0502   |
| -      | -                                  | -             | F-B, S-X               | Category 02 SW1         | -                | See glossary of terms in appendix B.               | 0503   |
| -      | -                                  | -             | F-B, S-Y               | Category 04 SW1         | -                | Substance.   | 0504   |
| -      | -                                  | -             | F-B, S-X               | Category 02 SW1         | -                | See glossary of terms in appendix B.               | 0505   |
| -      | -                                  | -             | F-B, S-X               | Category 01 SW1         | -                | See glossary of terms in appendix B.               | 0506   |
| -      | -                                  | -             | F-B, S-X               | Category 01 SW1         | -                | See glossary of terms in appendix B.               | 0507   |
| -      | -                                  | -             | F-B, S-Y               | Category 04 SW1         | -                | Substance.   | 0508   |
| -      | -                                  | -             | F-B, S-Y               | Category 02 SW1         | -                | See glossary of terms in appendix B.               | 0509   |
| -      | -                                  | -             | F-B, S-X               | Category 02 SW1         | -                | See glossary of terms in appendix B.               | 0510   |

Part 3 – Dangerous Goods List, special provisions and exceptions

Chapter 3.2 – Dangerous Goods List

| UN No. | Proper shipping name (PSN)  | Class or division | Subsidiary hazard(s) | Packing group  | Special provisions | Limited and excepted quantity provisions |                     | Packing      |              | IBC           |               |
|--------|---|-------------------|----------------------|----------------|--------------------|--|---------------------|--------------|--------------|---------------|---------------|
|        |   |                   |                      |                |                    | Limited quantities                       | Excepted quantities | Instructions | Provisions   | Instructions  | Provisions    |
| (1)    | (2)<br>3.1.2  | (3)<br>2.0        | (4)<br>2.0           | (5)<br>2.0.1.3 | (6)<br>3.3         | (7a)<br>3.4                              | (7b)<br>3.5         | (8)<br>4.1.4 | (9)<br>4.1.4 | (10)<br>4.1.4 | (11)<br>4.1.4 |
| 0511   | DETONATORS, ELECTRONIC programmable for blasting  | 1.1B              | –                    | –              | 399                | 0  | E0                  | P131         | –            | –             | –             |
| 0512   | DETONATORS, ELECTRONIC programmable for blasting  | 1.4B              | –                    | –              | 399                | 0  | E0                  | P131         | –            | –             | –             |
| 0513   | DETONATORS, ELECTRONIC programmable for blasting  | 1.4S              | –                    | –              | 347<br>399         | 0  | E0                  | P131         | –            | –             | –             |
| 0514   | FIRE SUPPRESSANT DISPERSING DEVICES   | 1.4S              | –                    | –              | 407                | 0  | E0                  | P135         | –            | –             | –             |
| 1001   | ACETYLENE, DISSOLVED  | 2.1               | –                    | –              | –                  | 0  | E0                  | P200         | –            | –             | –             |
| 1002   | AIR, COMPRESSED   | 2.2               | –                    | –              | 392<br>397         | 120 mL                                   | E1                  | P200         | –            | –             | –             |
| 1003   | AIR, REFRIGERATED LIQUID  | 2.2               | 5.1                  | –              | –                  | 0  | E0                  | P203         | –            | –             | –             |
| 1005   | AMMONIA, ANHYDROUS  | 2.3               | 8<br>P               | –              | 23<br>379          | 0  | E0                  | P200         | –            | –             | –             |
| 1006   | ARGON, COMPRESSED   | 2.2               | –                    | –              | 378<br>392<br>406  | 120 mL                                   | E1                  | P200         | –            | –             | –             |
| 1008   | BORON TRIFLUORIDE   | 2.3               | 8                    | –              | 373                | 0  | E0                  | P200         | –            | –             | –             |
| 1009   | BROMOTRIFLUOROMETHANE (REFRIGERANT GAS R 13B1)  | 2.2               | –                    | –              | –                  | 120 mL                                   | E1                  | P200         | –            | –             | –             |
| 1010   | BUTADIENES, STABILIZED or BUTADIENES AND HYDROCARBON MIXTURE, STABILIZED, containing more than 20% butadienes | 2.1               | –                    | –              | 386<br>402         | 0  | E0                  | P200         | –            | –             | –             |
| 1011   | BUTANE  | 2.1               | –                    | –              | 392                | 0  | E0                  | P200         | –            | –             | –             |
| 1012   | BUTYLENE  | 2.1               | –                    | –              | 398                | 0  | E0                  | P200         | –            | –             | –             |
| 1013   | CARBON DIOXIDE  | 2.2               | –                    | –              | 378<br>392<br>406  | 120 mL                                   | E1                  | P200         | –            | –             | –             |
| 1016   | CARBON MONOXIDE, COMPRESSED   | 2.3               | 2.1                  | –              | 974                | 0  | E0                  | P200         | –            | –             | –             |
| 1017   | CHLORINE  | 2.3               | 5.1/8<br>P           | –              | –                  | 0  | E0                  | P200         | –            | –             | –             |
| 1018   | CHLORODIFLUOROMETHANE (REFRIGERANT GAS R 22)  | 2.2               | –                    | –              | –                  | 120 mL                                   | E1                  | P200         | –            | –             | –             |

| UN No. | Portable tanks and bulk containers |               | EmS                    | Stowage and handling    | Segregation        | Properties and observations   | UN No. |
|--------|------------------------------------|---------------|------------------------|-------------------------|--------------------|---|--------|
|        | Tank instructions                  | Provisions    |                        |                         |                    |   |        |
| (12)   | (13)<br>4.2.5<br>4.3               | (14)<br>4.2.5 | (15)<br>5.4.3.4<br>7.8 | (16a)<br>7.1<br>7.3–7.7 | (16b)<br>7.2–7.7   | (17)  | (18)   |
| 0511   | –                                  | –             | –                      | F-B, S-X                | Category 05 SW1    | See glossary of terms in appendix B.  | 0511   |
| 0512   | –                                  | –             | –                      | F-B, S-X                | Category 05 SW1    | See glossary of terms in appendix B.  | 0512   |
| 0513   | –                                  | –             | –                      | F-B, S-X                | Category 01 SW1    | See glossary of terms in appendix B.  | 0513   |
| 0514   | –                                  | –             | –                      | F-B, S-X                | Category 01 SW1    | See glossary of terms in appendix B.  | 0514   |
| 1001   | –                                  | –             | –                      | <u>F-D, S-U</u>         | Category D SW1 SW2 | Flammable gas with slight odour. Explosive limits: 2.1% to 80%. Lighter than air (0.907). Rough handling and exposure to local heating should be avoided, since these conditions may result in delayed explosion. Empty cylinders should be carried with the same precautions as filled cylinders.  | 1001   |
| 1002   | –                                  | –             | –                      | F-C, S-V                | Category A         | Non-flammable gas.  | 1002   |
| 1003   | –                                  | T75           | –                      | <u>F-C, S-W</u>         | Category D         | Liquefied, non-flammable gas. Strong oxidizing agent. Mixtures of liquid air with combustible materials or oils may explode. May ignite organic materials.  | 1003   |
| 1005   | –                                  | T50           | –                      | F-C, S-U                | Category D SW2     | Liquefied, non-flammable, toxic and corrosive gas with a pungent odour. Lighter than air (0.6). Suffocating in low concentrations. Even though this substance has a flammability hazard, it only exhibits such hazard under extreme fire conditions in confined areas. Reacts violently with acids. Highly irritating to skin, eyes and mucous membranes.             | 1005   |
| 1006   | –                                  | –             | –                      | F-C, S-V                | Category A         | Inert gas. Heavier than air (1.4).  | 1006   |
| 1008   | –                                  | –             | –                      | F-C, S-U                | Category D SW2     | Non-flammable, toxic and corrosive gas. Forms dense white corrosive fumes in moist air. Reacts violently with water, evolving hydrogen fluoride, an irritating and corrosive gas apparent as white fumes. In the presence of moisture, highly corrosive to glass and most metals. Much heavier than air (2.35). Highly irritating to skin, eyes and mucous membranes. | 1008   |
| 1009   | –                                  | T50           | –                      | F-C, S-V                | Category A         | Liquefied, non-flammable gas with a slight odour. Much heavier than air (5.2).  | 1009   |
| 1010   | –                                  | T50           | –                      | F-D, S-U                | Category B SW1 SW2 | Liquefied, flammable gas with an unpleasant odour. Explosive limits: 2% to 12%. Heavier than air (1.84).  | 1010   |
| 1011   | –                                  | T50           | –                      | F-D, S-U                | Category E SW2     | Flammable hydrocarbon gas. Explosive limits: 1.8% to 8.4%. Heavier than air (2.11).   | 1011   |
| 1012   | –                                  | T50           | –                      | F-D, S-U                | Category E SW2     | Flammable hydrocarbon gas. Explosive limits: 1.6% to 10%. Heavier than air (2.0).   | 1012   |
| 1013   | –                                  | –             | –                      | F-C, S-V                | Category A         | Liquefied, non-flammable gas. Heavier than air (1.5). Cannot remain in the liquid state above 31°C.   | 1013   |
| 1016   | –                                  | –             | –                      | F-D, S-U                | Category D SW2     | Flammable, toxic, odourless gas. Explosive limits: 12% to 75%. Slightly lighter than air (0.97).  | 1016   |
| 1017   | –                                  | T50           | TP19                   | F-C, S-U                | Category D SW2     | Non-flammable, toxic and corrosive yellow gas with a pungent odour. Corrosive to glass and to most metals. Much heavier than air (2.4). Highly irritating to skin, eyes and mucous membranes. Powerful oxidant which may cause fire.  | 1017   |
| 1018   | –                                  | T50           | –                      | F-C, S-V                | Category A         | Liquefied, non-flammable gas with a chloroform-like odour. Much heavier than air (3.0).   | 1018   |

Part 3 – Dangerous Goods List, special provisions and exceptions

Chapter 3.2 – Dangerous Goods List

| UN No. | Proper shipping name (PSN)   | Class or division | Subsidiary hazard(s) | Packing group  | Special provisions | Limited and excepted quantity provisions |                     | Packing      |              | IBC           |               |
|--------|--|-------------------|----------------------|----------------|--------------------|--|---------------------|--------------|--------------|---------------|---------------|
|        |  |                   |                      |                |                    | Limited quantities                       | Excepted quantities | Instructions | Provisions   | Instructions  | Provisions    |
| (1)    | (2)<br>3.1.2   | (3)<br>2.0        | (4)<br>2.0           | (5)<br>2.0.1.3 | (6)<br>3.3         | (7a)<br>3.4                              | (7b)<br>3.5         | (8)<br>4.1.4 | (9)<br>4.1.4 | (10)<br>4.1.4 | (11)<br>4.1.4 |
| 1020   | CHLOROPENTAFLUORO-ETHANE (REFRIGERANT GAS R 115)   | 2.2               | -                    | -              | -                  | 120 mL                                   | E1                  | P200         | -            | -             | -             |
| 1021   | 1-CHLORO-1,2,2,2-TETRAFLUOROETHANE (REFRIGERANT GAS R 124)                                       | 2.2               | -                    | -              | -                  | 120 mL                                   | E1                  | P200         | -            | -             | -             |
| 1022   | CHLOROTRIFLUOROMETHANE (REFRIGERANT GAS R 13)  | 2.2               | -                    | -              | -                  | 120 mL                                   | E1                  | P200         | -            | -             | -             |
| 1023   | COAL GAS, COMPRESSED   | 2.3               | 2.1                  | -              | -                  | 0  | E0                  | P200         | -            | -             | -             |
| 1026   | CYANOGEN   | 2.3               | 2.1                  | -              | -                  | 0  | E0                  | P200         | -            | -             | -             |
| 1027   | CYCLOPROPANE   | 2.1               | -                    | -              | -                  | 0  | E0                  | P200         | -            | -             | -             |
| 1028   | DICHLORODIFLUOROMETHANE (REFRIGERANT GAS R 12)   | 2.2               | -                    | -              | -                  | 120 mL                                   | E1                  | P200         | -            | -             | -             |
| 1029   | DICHLOROFLUOROMETHANE (REFRIGERANT GAS R 21)   | 2.2               | -                    | -              | -                  | 120 mL                                   | E1                  | P200         | -            | -             | -             |
| 1030   | 1,1-DIFLUOROETHANE (REFRIGERANT GAS R 152a)  | 2.1               | -                    | -              | -                  | 0  | E0                  | P200         | -            | -             | -             |
| 1032   | DIMETHYLAMINE, ANHYDROUS   | 2.1               | -                    | -              | -                  | 0  | E0                  | P200         | -            | -             | -             |
| 1033   | DIMETHYL ETHER   | 2.1               | -                    | -              | -                  | 0  | E0                  | P200         | -            | -             | -             |
| 1035   | ETHANE   | 2.1               | -                    | -              | -                  | 0  | E0                  | P200         | -            | -             | -             |
| 1036   | ETHYLAMINE   | 2.1               | -                    | -              | 912                | 0  | E0                  | P200         | -            | -             | -             |
| 1037   | ETHYL CHLORIDE   | 2.1               | -                    | -              | -                  | 0  | E0                  | P200         | -            | -             | -             |
| 1038   | ETHYLENE, REFRIGERATED LIQUID  | 2.1               | -                    | -              | -                  | 0  | E0                  | P203         | -            | -             | -             |
| 1039   | ETHYL METHYL ETHER   | 2.1               | -                    | -              | -                  | 0  | E0                  | P200         | -            | -             | -             |
| 1040   | ETHYLENE OXIDE or ETHYLENE OXIDE WITH NITROGEN up to a total pressure of 1 MPa (10 bar) at 50°C  | 2.3               | 2.1                  | -              | 342                | 0  | E0                  | P200         | -            | -             | -             |
| 1041   | ETHYLENE OXIDE AND CARBON DIOXIDE MIXTURE with more than 9% but not more than 87% ethylene oxide | 2.1               | -                    | -              | -                  | 0  | E0                  | P200         | -            | -             | -             |
| 1043   | FERTILIZER AMMONIATING SOLUTION with free ammonia  | 2.2               | -                    | -              | -                  | 120 mL                                   | E0                  | P200         | -            | -             | -             |
| 1044   | FIRE EXTINGUISHERS with compressed or liquefied gas  | 2.2               | -                    | -              | 225                | 120 mL                                   | E0                  | P003         | PP91         | -             | -             |
| 1045   | FLUORINE, COMPRESSED   | 2.3               | 5.1/8                | -              | -                  | 0  | E0                  | P200         | -            | -             | -             |

| UN No. | Portable tanks and bulk containers |               | EmS                    | Stowage and handling    | Segregation      | Properties and observations   | UN No. |
|--------|------------------------------------|---------------|------------------------|-------------------------|------------------|---|--------|
|        | Tank instructions                  | Provisions    |                        |                         |                  |   |        |
| (12)   | (13)<br>4.2.5<br>4.3               | (14)<br>4.2.5 | (15)<br>5.4.3.4<br>7.8 | (16a)<br>7.1<br>7.3-7.7 | (16b)<br>7.2-7.7 | (17)  | (18)   |
| -      | T50                                | -             | F-C, S-V               | Category A              | -                | Liquefied, non-flammable gas. Much heavier than air (5.4).  | 1020   |
| -      | T50                                | -             | F-C, S-V               | Category A              | -                | Liquefied, non-flammable gas. Much heavier than air (4.7).  | 1021   |
| -      | -                                  | -             | F-C, S-V               | Category A              | -                | Liquefied, non-flammable gas. Much heavier than air (3.6). Cannot remain in the liquid state above 29°C.  | 1022   |
| -      | -                                  | -             | F-D, S-U               | Category D SW2          | -                | Flammable, toxic gas. Explosive limits: 4.5% to 40%. Much lighter than air (0.4 to 0.6).  | 1023   |
| -      | -                                  | -             | F-D, S-U               | Category D SW2          | -                | Liquefied, flammable, toxic gas with a pungent odour. Explosive limits: 6.6% to 43%. Heavier than air (1.9).  | 1026   |
| -      | T50                                | -             | F-D, S-U               | Category E SW2          | -                | Flammable hydrocarbon gas. Heavier than air.  | 1027   |
| -      | T50                                | -             | F-C, S-V               | Category A              | -                | Liquefied, non-flammable gas. Much heavier than air (4.2).  | 1028   |
| -      | T50                                | -             | F-C, S-V               | Category A              | -                | Liquefied, non-flammable gas with a chloroform-like odour. Much heavier than air (3.6). Boiling point: 9°C.   | 1029   |
| -      | T50                                | -             | F-D, S-U               | Category B SW2          | -                | Flammable gas. Explosive limits: 5% to 17%. Much heavier than air (2.3).  | 1030   |
| -      | T50                                | -             | F-D, S-U               | Category D SW2          | SG35             | Liquefied, flammable gas with an ammonia-like odour. Heavier than air (1.6). Boiling point: 7°C. Suffocating in low concentrations.   | 1032   |
| -      | T50                                | -             | F-D, S-U               | Category B SW2          | -                | Flammable gas with a chloroform-like odour. Heavier than air (1.6).   | 1033   |
| -      | -                                  | -             | F-D, S-U               | Category E SW2          | -                | Flammable gas. Explosive limits: 3% to 16%. Slightly heavier than air (1.05).   | 1035   |
| -      | T50                                | -             | F-D, S-U               | Category D SW2          | SG35             | Liquefied, flammable gas with an ammonia-like odour. Explosive limits: 3.5% to 14%. Heavier than air (1.6). Boiling point: 17°C.  | 1036   |
| -      | T50                                | -             | F-D, S-U               | Category B SW2          | -                | Liquefied, flammable gas. Explosive limits: 3.5% to 15%. Much heavier than air (2.2). Boiling point: 13°C.  | 1037   |
| -      | T75                                | TP5           | F-D, S-U               | Category D SW2          | -                | Liquefied, flammable gas. Explosive limits: 3% to 34%. Lighter than air (0.98).   | 1038   |
| -      | -                                  | -             | F-D, S-U               | Category B SW2          | -                | Liquefied, flammable gas. Explosive limits: 2% to 10%. Much heavier than air (2.1). Boiling point: 11°C.  | 1039   |
| -      | T50                                | TP20<br>TP90  | F-D, S-U               | Category D SW2          | -                | Liquefied, flammable, toxic gases with an ether-like odour. Heavier than air (1.5). Boiling point: 11°C.  | 1040   |
| -      | T50                                | -             | F-D, S-U               | Category B SW2          | -                | Liquefied, flammable gas with an ether-like odour. Heavier than air (1.5).  | 1041   |
| -      | -                                  | -             | F-C, S-V               | Category E SW2          | -                | Non-flammable aqueous solution of ammonium nitrate, calcium nitrate, urea and their mixtures containing ammonia gas. Emits toxic vapours of ammonia.  | 1043   |
| -      | -                                  | -             | F-C, S-V               | Category A              | -                | Fire extinguishers, containing compressed or liquefied gases under pressure above 175 kPa for expelling fire-extinguishing contents.  | 1044   |
| -      | -                                  | -             | F-C, S-W               | Category D SW2          | SG6<br>SG19      | Non-flammable, toxic and corrosive pale yellowish gas with a pungent odour. Powerful oxidant which may cause fire. Reacts with water or moist air to produce toxic and corrosive fumes. Corrosive to glass and to most metals. Will explode when mixed with hydrogen. Heavier than air (1.3). Highly irritating to skin, eyes and mucous membranes. | 1045   |

Part 3 – Dangerous Goods List, special provisions and exceptions

Chapter 3.2 – Dangerous Goods List

| UN No. | Proper shipping name (PSN)  | Class or division | Subsidiary hazard(s) | Packing group  | Special provisions       | Limited and excepted quantity provisions |                     | Packing      |              | IBC           |               |
|--------|---|-------------------|----------------------|----------------|--------------------------|--|---------------------|--------------|--------------|---------------|---------------|
|        |   |                   |                      |                |                          | Limited quantities                       | Excepted quantities | Instructions | Provisions   | Instructions  | Provisions    |
| (1)    | (2)<br>3.1.2  | (3)<br>2.0        | (4)<br>2.0           | (5)<br>2.0.1.3 | (6)<br>3.3               | (7a)<br>3.4                              | (7b)<br>3.5         | (8)<br>4.1.4 | (9)<br>4.1.4 | (10)<br>4.1.4 | (11)<br>4.1.4 |
| 1046   | HELIUM, COMPRESSED  | 2.2               | -                    | -              | 378<br>392<br>406<br>974 | 120 mL                                   | E1                  | P200         | -            | -             | -             |
| 1048   | HYDROGEN BROMIDE, ANHYDROUS   | 2.3               | 8                    | -              | -                        | 0  | E0                  | P200         | -            | -             | -             |
| 1049   | HYDROGEN, COMPRESSED  | 2.1               | -                    | -              | 392<br>974               | 0  | E0                  | P200         | -            | -             | -             |
| 1050   | HYDROGEN CHLORIDE, ANHYDROUS  | 2.3               | 8                    | -              | -                        | 0  | E0                  | P200         | -            | -             | -             |
| 1051   | HYDROGEN CYANIDE, STABILIZED containing less than 3% water                  | 6.1               | 3<br>P               | I              | 386                      | 0  | E0                  | P200         | -            | -             | -             |
| 1052   | HYDROGEN FLUORIDE, ANHYDROUS  | 8                 | 6.1                  | I              | -                        | 0  | E0                  | P200         | -            | -             | -             |
| 1053   | HYDROGEN SULPHIDE   | 2.3               | 2.1                  | -              | -                        | 0  | E0                  | P200         | -            | -             | -             |
| 1055   | ISOBUTYLENE   | 2.1               | -                    | -              | -                        | 0  | E0                  | P200         | -            | -             | -             |
| 1056   | KRYPTON, COMPRESSED   | 2.2               | -                    | -              | 378<br>392               | 120 mL                                   | E1                  | P200         | -            | -             | -             |
| 1057   | LIGHTERS or LIGHTER REFILLS containing flammable gas                        | 2.1               | -                    | -              | 201                      | 0  | E0                  | P002         | PP84         | -             | -             |
| 1058   | LIQUEFIED GASES non-flammable, charged with nitrogen, carbon dioxide or air | 2.2               | -                    | -              | 392                      | 120 mL                                   | E1                  | P200         | -            | -             | -             |
| 1060   | METHYLACETYLENE AND PROPADIENE MIXTURE, STABILIZED                          | 2.1               | -                    | -              | 386                      | 0  | E0                  | P200         | -            | -             | -             |
| 1061   | METHYLAMINE, ANHYDROUS  | 2.1               | -                    | -              | -                        | 0  | E0                  | P200         | -            | -             | -             |
| 1062   | METHYL BROMIDE with not more than 2.0% chloropicrin                         | 2.3               | -                    | -              | 23                       | 0  | E0                  | P200         | -            | -             | -             |
| 1063   | METHYL CHLORIDE (REFRIGERANT GAS R 40)                                      | 2.1               | -                    | -              | -                        | 0  | E0                  | P200         | -            | -             | -             |
| 1064   | METHYL MERCAPTAN  | 2.3               | 2.1<br>P             | -              | -                        | 0  | E0                  | P200         | -            | -             | -             |
| 1065   | NEON, COMPRESSED  | 2.2               | -                    | -              | 378<br>392               | 120 mL                                   | E1                  | P200         | -            | -             | -             |
| 1066   | NITROGEN, COMPRESSED  | 2.2               | -                    | -              | 378<br>392<br>406        | 120 mL                                   | E1                  | P200         | -            | -             | -             |
| 1067   | DINITROGEN TETROXIDE (NITROGEN DIOXIDE)                                     | 2.3               | 5.1/8                | -              | -                        | 0  | E0                  | P200         | -            | -             | -             |

| UN No. | Portable tanks and bulk containers |               | EmS                    | Stowage and handling    | Segregation          | Properties and observations  | UN No. |
|--------|------------------------------------|---------------|------------------------|-------------------------|----------------------|--|--------|
|        | Tank instructions                  | Provisions    |                        |                         |                      |  |        |
| (12)   | (13)<br>4.2.5<br>4.3               | (14)<br>4.2.5 | (15)<br>5.4.3.4<br>7.8 | (16a)<br>7.1<br>7.3-7.7 | (16b)<br>7.2-7.7     | (17)   | (18)   |
| -      | -                                  | -             | F-C, S-V               | Category A              | -                    | Inert gas. Much lighter than air (0.14).   | 1046   |
| -      | -                                  | -             | F-C, S-U               | Category D SW2          | -                    | Non-flammable, toxic and corrosive gas with a pungent odour. Highly corrosive in the presence of water. Much heavier than air (3.6). Highly irritating to the skin, eyes and mucous membranes.   | 1048   |
| -      | -                                  | -             | F-D, S-U               | Category E SW2          | SG46                 | Flammable, odourless gas. Explosive limits: 4% to 75%. Much lighter than air (0.07).   | 1049   |
| -      | -                                  | -             | F-C, S-U               | Category D SW2          | -                    | Non-flammable, toxic and corrosive colourless gas with a pungent odour. Highly corrosive in the presence of water. Heavier than air (1.3). Highly irritating to skin, eyes and mucous membranes.   | 1050   |
| -      | -                                  | -             | F-E, S-D               | Category D SW1 SW2      | -                    | Very volatile, colourless flammable liquid, evolving extremely toxic flammable vapours. Boiling point: 26°C. Flashpoint: -18°C c.c. Miscible with water. Highly toxic if swallowed, by skin contact or by inhalation.  | 1051   |
| -      | T10                                | TP2           | F-C, S-U               | Category D SW2          | SGG1<br>SG36<br>SG49 | Colourless, fuming and highly volatile liquid with an irritating and pungent odour. Highly corrosive to metals and glass in the presence of moisture. Boiling point: 20°C. Toxic if swallowed, by skin contact or by inhalation. Causes severe burns to skin, eyes and mucous membranes. | 1052   |
| -      | -                                  | -             | F-D, S-U               | Category D SW2          | -                    | Liquefied, flammable, toxic gas with a foul odour. Heavier than air (1.2).   | 1053   |
| -      | T50                                | -             | F-D, S-U               | Category E SW2          | -                    | Flammable hydrocarbon gas. Explosive limits: 1.8% to 8.8%. May contain propane, cyclopropane, propylene, butane, butylene, etc., in varying proportions. Heavier than air (1.94).  | 1055   |
| -      | -                                  | -             | F-C, S-V               | Category A              | -                    | Inert gas. Much heavier than air (2.9).  | 1056   |
| -      | -                                  | -             | F-D, S-U               | Category B SW2          | -                    | Lighters or lighter refills containing butane or other flammable gas.  | 1057   |
| -      | -                                  | -             | F-C, S-V               | Category A              | -                    | Non-flammable gases or mixtures of such gases which are used for filling receptacles from which the contents are to be dispersed under pressure. Vapour may be heavier than air.   | 1058   |
| -      | T50                                | -             | F-D, S-U               | Category B SW1 SW2      | -                    | Flammable gas. Explosive limits: 3% to 11%. Heavier than air (1.4).  | 1060   |
| -      | T50                                | -             | F-D, S-U               | Category B SW2          | SG35                 | Liquefied, flammable gas with an ammonia-like odour. Heavier than air (1.09).  | 1061   |
| -      | T50                                | -             | F-C, S-U               | Category D SW2          | -                    | Liquefied, toxic gas with a chloroform-like odour. Much heavier than air (3.3). Boiling point: 4.5°C. Even though this substance has a flammability hazard, it only exhibits such hazard under extreme fire conditions in confined areas.  | 1062   |
| -      | T50                                | -             | F-D, S-U               | Category D SW2          | -                    | Liquefied, flammable gas. Explosive limits: 8% to 20%. Heavier than air (1.8).   | 1063   |
| -      | T50                                | -             | F-D, S-U               | Category D SW2          | -                    | Liquefied, flammable, toxic gas with a foul odour. Heavier than air (1.7). Boiling point: 6°C.   | 1064   |
| -      | -                                  | -             | F-C, S-V               | Category A              | -                    | Inert gas. Lighter than air (0.7).   | 1065   |
| -      | -                                  | -             | F-C, S-V               | Category A              | -                    | Non-flammable, odourless gas. Lighter than air (0.97).   | 1066   |
| -      | T50                                | TP21          | F-C, S-W               | Category D SW2          | SG6<br>SG19          | Liquefied, non-flammable, toxic and corrosive gas which gives off brown vapour with a pungent odour. Strong oxidizing agent. Boiling point: 21°C. Highly irritating to skin, eyes and mucous membranes. Toxic by inhalation, with delayed effect, similar to phosgene.                   | 1067   |



Part 3 – Dangerous Goods List, special provisions and exceptions

Chapter 3.2 – Dangerous Goods List

| UN No. | Proper shipping name (PSN)                                    | Class or division | Subsidiary hazard(s) | Packing group  | Special provisions | Limited and excepted quantity provisions |                     | Packing      |              | IBC           |               |
|--------|---|-------------------|----------------------|----------------|--------------------|--|---------------------|--------------|--------------|---------------|---------------|
|        |   |                   |                      |                |                    | Limited quantities                       | Excepted quantities | Instructions | Provisions   | Instructions  | Provisions    |
| (1)    | (2)<br>3.1.2  | (3)<br>2.0        | (4)<br>2.0           | (5)<br>2.0.1.3 | (6)<br>3.3         | (7a)<br>3.4                              | (7b)<br>3.5         | (8)<br>4.1.4 | (9)<br>4.1.4 | (10)<br>4.1.4 | (11)<br>4.1.4 |
| 1069   | NITROSYL CHLORIDE   | 2.3               | 8                    | -              | -                  | 0  | E0                  | P200         | -            | -             | -             |
| 1070   | NITROUS OXIDE   | 2.2               | 5.1                  | -              | -                  | 0  | E0                  | P200         | -            | -             | -             |
| 1071   | OIL GAS, COMPRESSED   | 2.3               | 2.1                  | -              | -                  | 0  | E0                  | P200         | -            | -             | -             |
| 1072   | OXYGEN, COMPRESSED  | 2.2               | 5.1                  | -              | 355                | 0  | E0                  | P200         | -            | -             | -             |
| 1073   | OXYGEN, REFRIGERATED LIQUID                                   | 2.2               | 5.1                  | -              | -                  | 0  | E0                  | P203         | -            | -             | -             |
| 1075   | PETROLEUM GASES, LIQUEFIED                                    | 2.1               | -                    | -              | 392                | 0  | E0                  | P200         | -            | -             | -             |
| 1076   | PHOSGENE  | 2.3               | 8                    | -              | -                  | 0  | E0                  | P200         | -            | -             | -             |
| 1077   | PROPYLENE   | 2.1               | -                    | -              | -                  | 0  | E0                  | P200         | -            | -             | -             |
| 1078   | REFRIGERANT GAS, N.O.S.                                       | 2.2               | -                    | -              | 274                | 120 mL                                   | E1                  | P200         | -            | -             | -             |
| 1079   | SULPHUR DIOXIDE   | 2.3               | 8                    | -              | -                  | 0  | E0                  | P200         | -            | -             | -             |
| 1080   | SULPHUR HEXAFLUORIDE  | 2.2               | -                    | -              | 392                | 120 mL                                   | E1                  | P200         | -            | -             | -             |
| 1081   | TETRAFLUROETHYLENE, STABILIZED                                | 2.1               | -                    | -              | 386                | 0  | E0                  | P200         | -            | -             | -             |
| 1082   | TRIFLUOROCHLORO-ETHYLENE, STABILIZED (REFRIGERANT GAS R 1113) | 2.3               | 2.1                  | -              | 386                | 0  | E0                  | P200         | -            | -             | -             |
| 1083   | TRIMETHYLAMINE, ANHYDROUS                                     | 2.1               | -                    | -              | -                  | 0  | E0                  | P200         | -            | -             | -             |
| 1085   | VINYL BROMIDE, STABILIZED                                     | 2.1               | -                    | -              | 386                | 0  | E0                  | P200         | -            | -             | -             |
| 1086   | VINYL CHLORIDE, STABILIZED                                    | 2.1               | -                    | -              | 386                | 0  | E0                  | P200         | -            | -             | -             |
| 1087   | VINYL METHYL ETHER, STABILIZED                                | 2.1               | -                    | -              | 386                | 0  | E0                  | P200         | -            | -             | -             |
| 1088   | ACETAL  | 3                 | -                    | II             | -                  | 1 L                                      | E2                  | P001         | -            | IBC02         | -             |
| 1089   | ACETALDEHYDE  | 3                 | -                    | I              | -                  | 0  | E0                  | P001         | -            | -             | -             |

| UN No. | Portable tanks and bulk containers |               | EmS                    | Stowage and handling    | Segregation      | Properties and observations   | UN No. |
|--------|------------------------------------|---------------|------------------------|-------------------------|------------------|---|--------|
|        | Tank instructions                  | Provisions    |                        |                         |                  |   |        |
| (12)   | (13)<br>4.2.5<br>4.3               | (14)<br>4.2.5 | (15)<br>5.4.3.4<br>7.8 | (16a)<br>7.1<br>7.3-7.7 | (16b)<br>7.2-7.7 | (17)  | (18)   |
| -      | -                                  | -             | F-C, S-U               | Category D SW2          | -                | Non-flammable, toxic yellow gas with an irritating odour. Corrosive to steel. Much heavier than air (2.3). Highly irritating to skin, eyes and mucous membranes.  | 1069   |
| -      | -                                  | -             | F-C, S-W               | Category A SW2          | -                | Non-flammable gas. Strong oxidizing agent. Heavier than air (1.5).  | 1070   |
| -      | -                                  | -             | F-D, S-U               | Category D SW2          | -                | Flammable, toxic gas. A mixture of hydrocarbons and carbon monoxide.  | 1071   |
| -      | -                                  | -             | F-C, S-W               | Category A              | -                | Non-flammable, odourless gas. Strong oxidizing agent. Heavier than air (1.1).   | 1072   |
| -      | T75                                | TP5<br>TP22   | F-C, S-W               | Category D              | -                | Liquefied, non-flammable gas. Strong oxidizing agent. Mixtures of liquid oxygen with acetylene or oils may explode.   | 1073   |
| -      | T50                                | -             | F-D, S-U               | Category E SW2          | -                | Flammable hydrocarbon gases or mixtures obtained from natural gas or by distillation of mineral oils or coal, etc. May contain propane, cyclopropane, propylene, butane, butylene, etc., in varying proportions. Heavier than air.  | 1075   |
| -      | -                                  | -             | F-C, S-U               | Category D SW2          | -                | Liquefied, non-flammable, toxic and corrosive gas with a foul odour. Corrosive in the presence of water. Much heavier than air (3.5). Boiling point: 8°C. Highly irritating to skin, eyes and mucous membranes. This gas is particularly dangerous in that it may be inhaled without immediate effect but can cause severe damage and death after a few hours' delay. | 1076   |
| -      | T50                                | -             | F-D, S-U               | Category E SW2          | -                | Flammable hydrocarbon gas. Explosive limits: 2% to 11.1%. Heavier than air (1.5).   | 1077   |
| -      | T50                                | -             | F-C, S-V               | Category A              | -                | Different chlorofluorohydrocarbons or other non-flammable, non-toxic gases considered as refrigerant agents.  | 1078   |
| -      | T50                                | TP19          | F-C, S-U               | Category D SW2          | -                | Non-flammable, toxic and corrosive gas with a pungent odour. Much heavier than air (2.3). Highly irritating to skin, eyes and mucous membranes.   | 1079   |
| -      | -                                  | -             | F-C, S-V               | Category A              | -                | Liquefied, non-flammable, odourless gas. Much heavier than air (5.1).   | 1080   |
| -      | -                                  | -             | F-D, S-U               | Category E SW1 SW2      | -                | Liquefied, flammable gas. Explosive limits: 11% to 60%. Much heavier than air (3.5). Irritating to skin, eyes and mucous membranes.   | 1081   |
| -      | T50                                | -             | F-D, S-U               | Category D SW1 SW2      | -                | Flammable, toxic, odourless gas. Explosive limits: 8.4% to 38.7%. Much heavier than air (4.0).  | 1082   |
| -      | T50                                | -             | F-D, S-U               | Category B SW2          | SG35             | Liquefied, flammable gas with a fishy odour. Explosive limits: 2% to 12%. Much heavier than air (2.1). Boiling point: 3°C.  | 1083   |
| -      | T50                                | -             | F-D, S-U               | Category B SW1 SW2      | -                | Liquefied, flammable gas. Much heavier than air (3.7). Boiling point: 16°C.   | 1085   |
| -      | T50                                | -             | F-D, S-U               | Category B SW1 SW2      | -                | Liquefied, flammable gas. Explosive limits: 4% to 31%. Much heavier than air (2.2).   | 1086   |
| -      | T50                                | -             | F-D, S-U               | Category B SW1 SW2      | -                | Liquefied, flammable gas. Explosive limits: 2.6% to 39%. Heavier than air (2.0). Boiling point: 6°C.  | 1087   |
| -      | T4                                 | TP1           | F-E, S-D               | Category E              | -                | Colourless, volatile liquid with an agreeable odour. Flashpoint: below -18°C c.c. Explosive limits: 1.6% to 10.4%. Miscible with water.   | 1088   |
| -      | T11                                | TP2<br>TP7    | F-E, S-D               | Category E              | -                | Colourless liquid with a pungent, fruity odour. Flashpoint: -27°C c.c. Explosive limits: 4% to 57%. Boiling point: 21°C. Miscible with water. Harmful if swallowed or by inhalation.  | 1089   |

Part 3 – Dangerous Goods List, special provisions and exceptions

Chapter 3.2 – Dangerous Goods List

| UN No. | Proper shipping name (PSN) | Class or division | Subsidiary hazard(s) | Packing group  | Special provisions | Limited and excepted quantity provisions |                     | Packing      |              | IBC           |               |
|--------|----------------------------|-------------------|----------------------|----------------|--------------------|--|---------------------|--------------|--------------|---------------|---------------|
|        |                            |                   |                      |                |                    | Limited quantities                       | Excepted quantities | Instructions | Provisions   | Instructions  | Provisions    |
| (1)    | (2)<br>3.1.2               | (3)<br>2.0        | (4)<br>2.0           | (5)<br>2.0.1.3 | (6)<br>3.3         | (7a)<br>3.4                              | (7b)<br>3.5         | (8)<br>4.1.4 | (9)<br>4.1.4 | (10)<br>4.1.4 | (11)<br>4.1.4 |
| 1090   | ACETONE                    | 3                 | –                    | II             | –                  | 1 L                                      | E2                  | P001         | –            | IBC02         | –             |
| 1091   | ACETONE OILS               | 3                 | –                    | II             | –                  | 1 L                                      | E2                  | P001         | –            | IBC02         | –             |
| 1092   | ACROLEIN, STABILIZED       | 6.1               | 3<br>P               | I              | 354<br>386         | 0  | E0                  | P601         | –            | –             | –             |
| 1093   | ACRYLONITRILE, STABILIZED  | 3                 | 6.1                  | I              | 386                | 0  | E0                  | P001         | –            | –             | –             |
| 1098   | ALLYL ALCOHOL              | 6.1               | 3<br>P               | I              | 354                | 0  | E0                  | P602         | –            | –             | –             |
| 1099   | ALLYL BROMIDE              | 3                 | 6.1<br>P             | I              | –                  | 0  | E0                  | P001         | –            | –             | –             |
| 1100   | ALLYL CHLORIDE             | 3                 | 6.1                  | I              | –                  | 0  | E0                  | P001         | –            | –             | –             |
| 1104   | AMYL ACETATES              | 3                 | –                    | III            | –                  | 5 L                                      | E1                  | P001<br>LP01 | –            | IBC03         | –             |
| 1105   | PENTANOLS                  | 3                 | –                    | II             | –                  | 1 L                                      | E2                  | P001         | –            | IBC02         | –             |
| 1105   | PENTANOLS                  | 3                 | –                    | III            | 223                | 5 L                                      | E1                  | P001<br>LP01 | –            | IBC03         | –             |
| 1106   | AMYLAMINE                  | 3                 | 8                    | II             | –                  | 1 L                                      | E2                  | P001         | –            | IBC02         | –             |
| 1106   | AMYLAMINE                  | 3                 | 8                    | III            | 223                | 5 L                                      | E1                  | P001         | –            | IBC03         | –             |
| 1107   | AMYL CHLORIDE              | 3                 | –                    | II             | –                  | 1 L                                      | E2                  | P001         | –            | IBC02         | –             |
| 1108   | 1-PENTENE (n-AMYLENE)      | 3                 | –                    | I              | –                  | 0  | E3                  | P001         | –            | –             | –             |
| 1109   | AMYL FORMATES              | 3                 | –                    | III            | –                  | 5 L                                      | E1                  | P001<br>LP01 | –            | IBC03         | –             |
| 1110   | n-AMYL METHYL KETONE       | 3                 | –                    | III            | –                  | 5 L                                      | E1                  | P001<br>LP01 | –            | IBC03         | –             |

| UN No. | Portable tanks and bulk containers |                    | EmS                    | Stowage and handling     | Segregation      | Properties and observations  | UN No. |
|--------|------------------------------------|--------------------|------------------------|--------------------------|------------------|--|--------|
|        | Tank instructions                  | Provisions         |                        |                          |                  |  |        |
| (12)   | (13)<br>4.2.5<br>4.3               | (14)<br>4.2.5      | (15)<br>5.4.3.4<br>7.8 | (16a)<br>7.1<br>7.3–7.7  | (16b)<br>7.2–7.7 | (17)   | (18)   |
| –      | T4                                 | TP1                | F-E, S-D               | Category E               | –                | Colourless, clear liquid, with a characteristic mint-like odour. Flashpoint: –20°C to –18°C c.c. Explosive limits: 2.5% to 13%. Miscible with water.   | 1090   |
| –      | T4                                 | TP1<br>TP8         | F-E, S-D               | Category B               | –                | Light yellow to brownish, oily liquids. Flashpoint: –4°C to 8°C c.c. Immiscible with water.  | 1091   |
| –      | T22                                | TP2<br>TP7<br>TP13 | F-E, S-D               | Category D<br>SW1<br>SW2 | –                | Colourless or yellow liquid with a most irritating odour. Flashpoint: –26°C c.c. Explosive limits: 2.8% to 31%. Boiling point: 52°C. Miscible with water. Highly toxic if swallowed, by skin contact or by inhalation.   | 1092   |
| –      | T14                                | TP2<br>TP13        | F-E, S-D               | Category D<br>SW1<br>SW2 | –                | Colourless, mobile liquid with a mild pungent odour. Flashpoint: –5°C c.c. Explosive limits: 3% to 17%. Partially miscible with water. Toxic if swallowed, by skin contact or by inhalation. Practice has shown that this substance may leak from packagings that ordinarily are leakproof to other chemicals. | 1093   |
| –      | T20                                | TP2<br>TP13        | F-E, S-D               | Category D<br>SW2        | –                | Colourless liquid with a pungent mustard-like odour. Flashpoint: 21°C c.c. Explosive limits: 2.5% to 18%. Miscible with water. Highly toxic if swallowed, by skin contact or by inhalation.  | 1098   |
| –      | T14                                | TP2<br>TP13        | F-E, S-D               | Category B<br>SW2        | SGG10            | Colourless to light yellow liquid with an irritating odour. Flashpoint: –1°C c.c. Explosive limits: 4.4% to 7.3%. Immiscible with water. Highly toxic if swallowed, by skin contact or by inhalation.  | 1099   |
| –      | T14                                | TP2<br>TP13        | F-E, S-D               | Category E<br>SW2        | SGG10            | Colourless liquid with an unpleasant pungent odour. Flashpoint: –29°C c.c. Explosive limits: 3.3% to 11.1%. Boiling point: 44°C. Immiscible with water. Toxic if swallowed, by skin contact or by inhalation.  | 1100   |
| –      | T2                                 | TP1                | F-E, S-D               | Category A               | –                | Colourless liquids with a pear- or banana-like odour. <i>normal</i> -AMYL ACETATE: flashpoint 25°C c.c. <i>secondary</i> -AMYL ACETATE: flashpoint 32°C c.c. Immiscible with water.  | 1104   |
| –      | T4                                 | TP1<br>TP29        | F-E, S-D               | Category B               | –                | Colourless liquids with a strong odour. Immiscible with water. <i>tertiary</i> -AMYL ALCOHOL: flashpoint 19°C to 21°C c.c.   | 1105   |
| –      | T2                                 | TP1                | F-E, S-D               | Category A               | –                | See entry above. Explosive limits: 1.2% to 10.5%.  | 1105   |
| –      | T7                                 | TP1                | F-E, S-C               | Category B               | SG35             | Colourless, clear liquids. Explosive limits: 2.2% to 22%. <i>normal</i> -AMYLAMINE (1-PENTYLAMINE): flashpoint 4°C c.c. <i>tertiary</i> -AMYLAMINE (3-PENTYLAMINE): flashpoint 2°C c.c. Miscible with water. Harmful by inhalation. Cause burns to skin, eyes and mucous membranes.                            | 1106   |
| –      | T4                                 | TP1                | F-E, S-C               | Category A               | SG35             | See entry above. However, irritating to skin, eyes and mucous membranes.   | 1106   |
| –      | T4                                 | TP1                | F-E, S-D               | Category B               | SGG10            | Colourless or light brown liquids with an aromatic odour. <i>n</i> -AMYL CHLORIDE: flashpoint 11°C. Explosive limits: <i>normal</i> -AMYL CHLORIDE 1.4% to 8.6%. Immiscible with water.  | 1107   |
| –      | T11                                | TP2                | F-E, S-D               | Category E               | –                | Colourless, volatile liquid with a disagreeable odour. Flashpoint: –20°C c.c. Explosive limits: 1.4% to 8.7%. Boiling point: 30°C. Immiscible with water. Irritating to skin, eyes and mucous membranes. Narcotic in high concentrations.  | 1108   |
| –      | T2                                 | TP1                | F-E, S-D               | Category A               | –                | Colourless liquids with a pleasant odour. <i>normal</i> -AMYL FORMATE: flashpoint 27°C c.c. ISOAMYL FORMATE: flashpoint 26°C c.c. Explosive limits: 1.7% to 10%. Immiscible with water.  | 1109   |
| –      | T2                                 | TP1                | F-E, S-D               | Category A               | –                | Colourless liquid. Flashpoint: 49°C c.c. Immiscible with water.  | 1110   |

| UN No. | Proper shipping name (PSN) | Class or division | Subsidiary hazard(s) | Packing group  | Special provisions | Limited and excepted quantity provisions |                     | Packing      |              | IBC           |               |
|--------|----------------------------|-------------------|----------------------|----------------|--------------------|--|---------------------|--------------|--------------|---------------|---------------|
|        |                            |                   |                      |                |                    | Limited quantities                       | Excepted quantities | Instructions | Provisions   | Instructions  | Provisions    |
| (1)    | (2)<br>3.1.2               | (3)<br>2.0        | (4)<br>2.0           | (5)<br>2.0.1.3 | (6)<br>3.3         | (7a)<br>3.4                              | (7b)<br>3.5         | (8)<br>4.1.4 | (9)<br>4.1.4 | (10)<br>4.1.4 | (11)<br>4.1.4 |
| 1111   | AMYL MERCAPTAN             | 3                 | –                    | II             | –                  | 1 L                                      | E2                  | P001         | –            | IBC02         | –             |
| 1112   | AMYL NITRATE               | 3                 | –                    | III            | –                  | 5 L                                      | E1                  | P001<br>LP01 | –            | IBC03         | –             |
| 1113   | AMYL NITRITE               | 3                 | –                    | II             | –                  | 1 L                                      | E2                  | P001         | –            | IBC02         | –             |
| 1114   | BENZENE                    | 3                 | –                    | II             | –                  | 1 L                                      | E2                  | P001         | –            | IBC02         | –             |
| 1120   | BUTANOLS                   | 3                 | –                    | II             | –                  | 1 L                                      | E2                  | P001         | –            | IBC02         | –             |
| 1120   | BUTANOLS                   | 3                 | –                    | III            | 223                | 5 L                                      | E1                  | P001<br>LP01 | –            | IBC03         | –             |
| 1123   | BUTYL ACETATES             | 3                 | –                    | II             | –                  | 1 L                                      | E2                  | P001         | –            | IBC02         | –             |
| 1123   | BUTYL ACETATES             | 3                 | –                    | III            | 223                | 5 L                                      | E1                  | P001<br>LP01 | –            | IBC03         | –             |
| 1125   | <i>n</i> -BUTYLAMINE       | 3                 | 8                    | II             | –                  | 1 L                                      | E2                  | P001         | –            | IBC02         | –             |
| 1126   | 1-BROMOBUTANE              | 3                 | –                    | II             | –                  | 1 L                                      | E2                  | P001         | –            | IBC02         | –             |
| 1127   | CHLOROBUTANES              | 3                 | –                    | II             | –                  | 1 L                                      | E2                  | P001         | –            | IBC02         | –             |
| 1128   | <i>n</i> -BUTYL FORMATE    | 3                 | –                    | II             | –                  | 1 L                                      | E2                  | P001         | –            | IBC02         | –             |
| 1129   | BUTYRALDEHYDE              | 3                 | –                    | II             | –                  | 1 L                                      | E2                  | P001         | –            | IBC02         | –             |
| 1130   | CAMPHOR OIL                | 3                 | –                    | III            | –                  | 5 L                                      | E1                  | P001<br>LP01 | –            | IBC03         | –             |
| 1131   | CARBON DISULPHIDE          | 3                 | 6.1                  | I              | –                  | 0  | E0                  | P001         | PP31         | –             | –             |

| UN No. | Portable tanks and bulk containers |                    | EmS                    | Stowage and handling    | Segregation      | Properties and observations  | UN No. |
|--------|------------------------------------|--------------------|------------------------|-------------------------|------------------|--|--------|
|        | Tank instructions                  | Provisions         |                        |                         |                  |  |        |
| (12)   | (13)<br>4.2.5<br>4.3               | (14)<br>4.2.5      | (15)<br>5.4.3.4<br>7.8 | (16a)<br>7.1<br>7.3–7.7 | (16b)<br>7.2–7.7 | (17)   | (18)   |
| –      | T4                                 | TP1                | F-E, S-D               | Category B              | SG50<br>SG57     | Colourless to yellow liquids with an extremely disagreeable garlic-like odour.<br><i>tertiary</i> -AMYL MERCAPTAN: flashpoint –7°C c.c.<br><i>normal</i> -AMYL MERCAPTAN: flashpoint 19°C c.c.<br>ISOAMYL MERCAPTAN: flashpoint 18°C c.c.<br>Immiscible with water. These substances may leak from packagings that ordinarily are leakproof to other chemicals.  | 1111   |
| –      | T2                                 | TP1                | F-E, S-D               | Category A<br>SW2       | –                | Colourless liquids with an ether-like odour.<br><i>normal</i> -AMYL NITRATE: flashpoint 48°C c.c.<br>ISOAMYL NITRATE: flashpoint 52°C c.c.<br>Immiscible with water. Harmful by inhalation.  | 1112   |
| –      | T4                                 | TP1                | F-E, S-D               | Category E<br>SW2       | –                | Yellowish, transparent, volatile liquid with a fragrant fruity odour.<br>Flashpoint of the pure ISOAMYL NITRITE: –20°C c.c.<br>Flashpoint of pure <i>normal</i> -AMYL NITRITE: 10°C c.c.<br>Decomposes on exposure to air, light or water, evolving toxic nitrous fumes which are orange in colour. Immiscible with water.<br>Harmful by inhalation.   | 1113   |
| –      | T4                                 | TP1                | F-E, S-D               | Category B<br>SW2       | –                | Colourless liquid with a characteristic odour. Flashpoint: –11°C c.c.<br>Explosive limits: 1.4% to 8%. Freezing point 5°C; flashes below its freezing point. Immiscible with water. Narcotic. Exposure to this substance may produce serious chronic effects of a toxic nature.  | 1114   |
| –      | T4                                 | TP1<br>TP29        | F-E, S-D               | Category B              | –                | Colourless liquids with a disagreeable odour.<br>Explosive limits: <i>normal</i> -BUTANOL 1.4% to 11.2%.<br><i>secondary</i> -BUTANOL 1.7% to 9.8%. <i>tertiary</i> -BUTANOL 2.4% to 8%.<br><i>tertiary</i> -BUTANOL solidifies at about 25°C. <i>normal</i> -BUTANOL is immiscible with water. <i>secondary</i> -BUTANOL is immiscible with water. <i>tertiary</i> -BUTANOL is miscible with water.<br>Irritating to skin, eyes and mucous membranes.   | 1120   |
| –      | T2                                 | TP1                | F-E, S-D               | Category A              | –                | See entry above.   | 1120   |
| –      | T4                                 | TP1                | F-E, S-D               | Category B              | –                | Colourless liquids with a pineapple-like odour. Immiscible with water.<br><i>normal</i> -BUTYL ACETATE: flashpoint 27°C c.c.<br>Explosive limits: 1.5% to 15%.   | 1123   |
| –      | T2                                 | TP1                | F-E, S-D               | Category A              | –                | See entry above.   | 1123   |
| –      | T7                                 | TP1                | F-E, S-C               | Category B<br>SW2       | SG35             | Flashpoint: –9°C c.c. Explosive limits: 1.7% to 10%.<br>Colourless, volatile liquid with an ammonia-like odour. Miscible with water. Causes burns to skin, eyes and mucous membranes.  | 1125   |
| –      | T4                                 | TP1                | F-E, S-D               | Category B<br>SW2       | SGG10            | Colourless to pale straw-coloured, clear liquid. Flashpoint: 13°C c.c.<br>Explosive limits: 2.6% to 6.6%. Immiscible with water. Narcotic.   | 1126   |
| –      | T4                                 | TP1                | F-E, S-D               | Category B              | SGG10            | Colourless liquids.<br><i>tertiary</i> -BUTYL CHLORIDE: flashpoint –30°C c.c., boiling point 51°C.<br>Immiscible with water.   | 1127   |
| –      | T4                                 | TP1                | F-E, S-D               | Category B              | –                | Colourless liquid. Flashpoint: 18°C c.c.<br>Explosive limits: 1.6% to 8.3%. Immiscible with water.   | 1128   |
| –      | T4                                 | TP1                | F-E, S-D               | Category B              | –                | Colourless liquid with a characteristic pungent odour.<br>Flashpoint: –7°C c.c. Explosive limits: 1.4% to 12.5%.<br>Immiscible with water.   | 1129   |
| –      | T2                                 | TP1                | F-E, S-E               | Category A              | –                | Colourless oil with a characteristic odour. Flashpoint: 47°C c.c.<br>Immiscible with water.  | 1130   |
| –      | T14                                | TP2<br>TP7<br>TP13 | F-E, S-D               | Category D<br>SW2       | SG63             | Colourless or faintly yellow, clear liquid, almost odourless when pure; the commercial substance has a strong disagreeable odour.<br>Flashpoint: –30°C c.c. Explosive limits: 1% to 60%.<br>Boiling point: 46°C. Ignition temperature: 100°C. Immiscible with water. Vapours are heavier than air, will travel a considerable distance to a source of ignition and will flash back. Vapours may be ignited by contact with an ordinary light bulb or a warm steam pipe.<br>Toxic if swallowed, by skin contact or by inhalation. | 1131   |



Part 3 – Dangerous Goods List, special provisions and exceptions

Chapter 3.2 – Dangerous Goods List

| UN No. | Proper shipping name (PSN)  | Class or division | Subsidiary hazard(s) | Packing group  | Special provisions | Limited and excepted quantity provisions |                     | Packing      |              | IBC           |               |
|--------|---|-------------------|----------------------|----------------|--------------------|--|---------------------|--------------|--------------|---------------|---------------|
|        |   |                   |                      |                |                    | Limited quantities                       | Excepted quantities | Instructions | Provisions   | Instructions  | Provisions    |
| (1)    | (2)<br>3.1.2  | (3)<br>2.0        | (4)<br>2.0           | (5)<br>2.0.1.3 | (6)<br>3.3         | (7a)<br>3.4                              | (7b)<br>3.5         | (8)<br>4.1.4 | (9)<br>4.1.4 | (10)<br>4.1.4 | (11)<br>4.1.4 |
| 1133   | ADHESIVES containing flammable liquid   | 3                 | –                    | I              | –                  | 500 mL                                   | E3                  | P001         | –            | –             | –             |
| 1133   | ADHESIVES containing flammable liquid   | 3                 | –                    | II             | –                  | 5 L                                      | E2                  | P001         | PP1          | IBC02         | –             |
| 1133   | ADHESIVES containing flammable liquid   | 3                 | –                    | III            | 223<br>955         | 5 L                                      | E1                  | P001<br>LP01 | PP1          | IBC03         | –             |
| 1134   | CHLOROBENZENE   | 3                 | –                    | III            | –                  | 5 L                                      | E1                  | P001<br>LP01 | –            | IBC03         | –             |
| 1135   | ETHYLENE CHLOROXYDRIN   | 6.1               | 3                    | I              | 354                | 0  | E0                  | P602         | –            | –             | –             |
| 1136   | COAL TAR DISTILLATES, FLAMMABLE   | 3                 | –                    | II             | –                  | 1 L                                      | E2                  | P001         | –            | IBC02         | –             |
| 1136   | COAL TAR DISTILLATES, FLAMMABLE   | 3                 | –                    | III            | 223<br>955         | 5 L                                      | E1                  | P001<br>LP01 | –            | IBC03         | –             |
| 1139   | COATING SOLUTION (includes surface treatments or coatings used for industrial or other purposes such as vehicle under-coating, drum or barrel lining) | 3                 | –                    | I              | –                  | 500 mL                                   | E3                  | P001         | –            | –             | –             |
| 1139   | COATING SOLUTION (includes surface treatments or coatings used for industrial or other purposes such as vehicle under-coating, drum or barrel lining) | 3                 | –                    | II             | –                  | 5 L                                      | E2                  | P001         | –            | IBC02         | –             |
| 1139   | COATING SOLUTION (includes surface treatments or coatings used for industrial or other purposes such as vehicle under-coating, drum or barrel lining) | 3                 | –                    | III            | 955                | 5 L                                      | E1                  | P001<br>LP01 | –            | IBC03         | –             |
| 1143   | CROTONALDEHYDE or CROTONALDEHYDE, STABILIZED  | 6.1               | 3<br>P               | I              | 324<br>354<br>386  | 0  | E0                  | P602         | –            | –             | –             |
| 1144   | CROTONYLENE   | 3                 | –                    | I              | –                  | 0  | E3                  | P001         | –            | –             | –             |
| 1145   | CYCLOHEXANE   | 3                 | –                    | II             | –                  | 1 L                                      | E2                  | P001         | –            | IBC02         | –             |
| 1146   | CYCLOPENTANE  | 3                 | –                    | II             | –                  | 1 L                                      | E2                  | P001         | –            | IBC02         | –             |
| 1147   | DECAHYDRONAPHTHALENE  | 3                 | –                    | III            | –                  | 5 L                                      | E1                  | P001<br>LP01 | –            | IBC03         | –             |
| 1148   | DIACETONE ALCOHOL   | 3                 | –                    | II             | –                  | 1 L                                      | E2                  | P001         | –            | IBC02         | –             |
| 1148   | DIACETONE ALCOHOL   | 3                 | –                    | III            | 223                | 5 L                                      | E1                  | P001<br>LP01 | –            | IBC03         | –             |
| 1149   | DIBUTYL ETHERS  | 3                 | –                    | III            | –                  | 5 L                                      | E1                  | P001         | –            | IBC03         | –             |

| UN No. | Portable tanks and bulk containers |                    | EmS                    | Stowage and handling     | Segregation      | Properties and observations   | UN No. |
|--------|------------------------------------|--------------------|------------------------|--------------------------|------------------|---|--------|
|        | Tank instructions                  | Provisions         |                        |                          |                  |   |        |
| (12)   | (13)<br>4.2.5<br>4.3               | (14)<br>4.2.5      | (15)<br>5.4.3.4<br>7.8 | (16a)<br>7.1<br>7.3–7.7  | (16b)<br>7.2–7.7 | (17)  | (18)   |
| –      | T11                                | TP1<br>TP8<br>TP27 | F-E, S-D               | Category E               | –                | Adhesives are solutions of gums, resins, etc., usually volatile due to the solvents. Miscibility with water depends upon their composition.   | 1133   |
| –      | T4                                 | TP1<br>TP8         | F-E, S-D               | Category B               | –                | See entry above.  | 1133   |
| –      | T2                                 | TP1                | F-E, S-D               | Category A               | –                | See entry above.  | 1133   |
| –      | T2                                 | TP1                | F-E, S-D               | Category A               | SGG10            | Colourless liquid with an almond-like odour. Flashpoint: 29°C c.c. Explosive limits: 1.3% to 11%. Immiscible with water.  | 1134   |
| –      | T20                                | TP2<br>TP13        | F-E, S-D               | Category D<br>SW2        | –                | Colourless flammable liquid with a faint, ethereal odour. Flashpoint: 60°C o.c. Explosive limits: 4.9% to 15.9%. Miscible with water. When involved in a fire, evolves extremely toxic (phosgene) and corrosive (hydrogen chloride) fumes. Highly toxic if swallowed, by skin contact or by inhalation. | 1135   |
| –      | T4                                 | TP1                | F-E, S-E               | Category B               | –                | Immiscible with water. May form extremely sensitive compounds with heavy metals or their salts.   | 1136   |
| –      | T4                                 | TP1<br>TP29        | F-E, S-E               | Category A               | –                | See entry above.  | 1136   |
| –      | T11                                | TP1<br>TP8<br>TP27 | F-E, S-E               | Category E               | –                | Miscibility with water depends upon the composition.  | 1139   |
| –      | T4                                 | TP1<br>TP8         | F-E, S-E               | Category B               | –                | See entry above.  | 1139   |
| –      | T2                                 | TP1                | F-E, S-E               | Category A               | –                | See entry above.  | 1139   |
| –      | T20                                | TP2<br>TP13        | F-E, S-D               | Category D<br>SW1<br>SW2 | –                | Colourless, mobile liquid with a pungent odour. Turns to pale yellow in contact with light and air. Miscible with water. Flashpoint: 13°C c.c. Highly toxic if swallowed, by skin contact or by inhalation. May cause lung damage.  | 1143   |
| –      | T11                                | TP2                | F-E, S-D               | Category E               | –                | Colourless liquid. Flashpoint: –53°C c.c. Lower explosive limit: 1.4%. Boiling point: 27°C. Immiscible with water.  | 1144   |
| –      | T4                                 | TP1                | F-E, S-D               | Category E               | –                | Colourless, mobile liquid with a sweet aromatic odour. Flashpoint: –18°C c.c. Explosive limits: 1.2% to 8.4%. Immiscible with water. Slightly irritating to skin, eyes and mucous membranes. Narcotic in high concentrations.   | 1145   |
| –      | T7                                 | TP1                | F-E, S-D               | Category E               | –                | Colourless liquid with a pungent odour. Flashpoint: below –18°C c.c. Explosive limits: 1.4% to 8%. Boiling point: 49°C. Immiscible with water. Irritating to skin, eyes and mucous membranes. Narcotic in high concentrations.  | 1146   |
| –      | T2                                 | TP1                | F-E, S-D               | Category A               | –                | Colourless liquids with an aromatic odour. Flashpoint: 52°C to 57°C c.c. Explosive limits: 0.7% to 4.9%. Immiscible with water. Harmful by inhalation.  | 1147   |
| –      | T4                                 | TP1                | F-E, S-D               | Category B               | –                | Colourless liquid. Explosive limits: 1.4% to 8%. Miscible with water.   | 1148   |
| –      | T2                                 | TP1                | F-E, S-D               | Category A               | –                | See entry above.  | 1148   |
| –      | T2                                 | TP1                | F-E, S-D               | Category A               | –                | Colourless liquids with a mild ether-like odour. Explosive limits: 0.9% to 8.5%. Immiscible with water. <i>normal</i> -DIBUTYL ETHER: flashpoint 25°C c.c.  | 1149   |

Part 3 – Dangerous Goods List, special provisions and exceptions

Chapter 3.2 – Dangerous Goods List

| UN No. | Proper shipping name (PSN)       | Class or division | Subsidiary hazard(s) | Packing group  | Special provisions | Limited and excepted quantity provisions |                     | Packing      |              | IBC           |               |
|--------|----------------------------------|-------------------|----------------------|----------------|--------------------|--|---------------------|--------------|--------------|---------------|---------------|
|        |                                  |                   |                      |                |                    | Limited quantities                       | Excepted quantities | Instructions | Provisions   | Instructions  | Provisions    |
| (1)    | (2)<br>3.1.2                     | (3)<br>2.0        | (4)<br>2.0           | (5)<br>2.0.1.3 | (6)<br>3.3         | (7a)<br>3.4                              | (7b)<br>3.5         | (8)<br>4.1.4 | (9)<br>4.1.4 | (10)<br>4.1.4 | (11)<br>4.1.4 |
| 1150   | 1,2-DICHLOROETHYLENE             | 3                 | –                    | II             | –                  | 1 L                                      | E2                  | P001         | –            | IBC02         | –             |
| 1152   | DICHLOROPENTANES                 | 3                 | –                    | III            | –                  | 5 L                                      | E1                  | P001<br>LP01 | –            | IBC03         | –             |
| 1153   | ETHYLENE GLYCOL DIETHYL ETHER    | 3                 | –                    | II             | –                  | 1 L                                      | E2                  | P001         | –            | IBC02         | –             |
| 1153   | ETHYLENE GLYCOL DIETHYL ETHER    | 3                 | –                    | III            | –                  | 5 L                                      | E1                  | P001<br>LP01 | –            | IBC03         | –             |
| 1154   | DIETHYLAMINE                     | 3                 | 8                    | II             | –                  | 1 L                                      | E2                  | P001         | –            | IBC02         | –             |
| 1155   | DIETHYL ETHER (ETHYL ETHER)      | 3                 | –                    | I              | –                  | 0  | E3                  | P001         | –            | –             | –             |
| 1156   | DIETHYL KETONE                   | 3                 | –                    | II             | –                  | 1 L                                      | E2                  | P001         | –            | IBC02         | –             |
| 1157   | DIISOBUTYL KETONE                | 3                 | –                    | III            | –                  | 5 L                                      | E1                  | P001<br>LP01 | –            | IBC03         | –             |
| 1158   | DIISOPROPYLAMINE                 | 3                 | 8                    | II             | –                  | 1 L                                      | E2                  | P001         | –            | IBC02         | –             |
| 1159   | DIISOPROPYL ETHER                | 3                 | –                    | II             | –                  | 1 L                                      | E2                  | P001         | –            | IBC02         | –             |
| 1160   | DIMETHYLAMINE, AQUEOUS SOLUTION  | 3                 | 8                    | II             | –                  | 1 L                                      | E2                  | P001         | –            | IBC02         | –             |
| 1161   | DIMETHYL CARBONATE               | 3                 | –                    | II             | –                  | 1 L                                      | E2                  | P001         | –            | IBC02         | –             |
| 1162   | DIMETHYLDICHLOROSILANE           | 3                 | 8                    | II             | –                  | 0  | E0                  | P010         | –            | –             | –             |
| 1163   | DIMETHYLHYDRAZINE, UNSYMMETRICAL | 6.1               | 3/8<br>P             | I              | 354                | 0  | E0                  | P602         | –            | –             | –             |
| 1164   | DIMETHYL SULPHIDE                | 3                 | –                    | II             | –                  | 1 L                                      | E2                  | P001         | –            | IBC02         | B8            |
| 1165   | DIOXANE                          | 3                 | –                    | II             | –                  | 1 L                                      | E2                  | P001         | –            | IBC02         | –             |

| UN No. | Portable tanks and bulk containers |                    | EmS                    | Stowage and handling    | Segregation                         | Properties and observations  | UN No. |
|--------|------------------------------------|--------------------|------------------------|-------------------------|-------------------------------------|--|--------|
|        | Tank instructions                  | Provisions         |                        |                         |                                     |  |        |
| (12)   | (13)<br>4.2.5<br>4.3               | (14)<br>4.2.5      | (15)<br>5.4.3.4<br>7.8 | (16a)<br>7.1<br>7.3–7.7 | (16b)<br>7.2–7.7                    | (17)   | (18)   |
| –      | T7                                 | TP2                | F-E, S-D               | Category B              | SGG10                               | Colourless liquid with a chloroform-like odour. Flashpoint: 6°C c.c. Explosive limits: 5.6% to 16%. Immiscible with water. Boiling range: 48°C to 61°C.  | 1150   |
| –      | T2                                 | TP1                | F-E, S-D               | Category A              | SGG10                               | Light yellow liquids. 1,5-DICHLOROPENTANE: flashpoint 26°C c.c. Immiscible with water.   | 1152   |
| –      | T4                                 | TP1                | F-E, S-D               | Category A              | –                                   | Colourless liquid with an ether-like odour. Flashpoint: 35°C c.c. Immiscible with water.   | 1153   |
| –      | T2                                 | TP1                | F-E, S-D               | Category A              | –                                   | See entry above.   | 1153   |
| –      | T7                                 | TP1                | F-E, S-C               | Category E<br>SW2       | SG35                                | Colourless liquid with an ammonia-like odour. Flashpoint: –39°C c.c. Explosive limits: 1.7% to 10.1%. Boiling point: 55°C. Miscible with water. Harmful if swallowed. Causes burns to skin, eyes and mucous membranes. Higher concentrations cause dangerous lung irritation.  | 1154   |
| –      | T11                                | TP2                | F-E, S-D               | Category E<br>SW2       | –                                   | Colourless, volatile and mobile liquid with a pleasant aromatic odour. Flashpoint: –40°C c.c. Explosive limits: 1.7% to 48%. Boiling point: 34°C. Immiscible with water. In the presence of oxygen or on long standing or exposure to sunlight, unstable peroxides sometimes form; these may explode spontaneously or when heated. Strongly narcotic. Readily ignited by static electricity. | 1155   |
| –      | T4                                 | TP1                | F-E, S-D               | Category B              | –                                   | Colourless, mobile liquid. Flashpoint: 13°C c.c. Lower explosive limit: 1.6%. Immiscible with water.   | 1156   |
| –      | T2                                 | TP1                | F-E, S-D               | Category A              | –                                   | Colourless liquid. Flashpoint: 49°C c.c. Explosive limits: 0.8% to 7.1%. Immiscible with water.  | 1157   |
| –      | T7                                 | TP1                | F-E, S-C               | Category B              | SG35                                | Colourless, volatile liquid with a fishy odour. Flashpoint: –7°C c.c. Explosive limits: 1.1% to 7.1%. Partially miscible with water. Harmful by inhalation. Causes burns to skin, eyes and mucous membranes.   | 1158   |
| –      | T4                                 | TP1                | F-E, S-D               | Category E<br>SW2       | –                                   | Colourless liquid with an ether-like odour. Flashpoint: –29°C c.c. Explosive limits: 1.1% to 21%. Immiscible with water. In the presence of oxygen or on long standing or exposure to sunlight, unstable peroxides sometimes form; these may explode spontaneously or when heated. Strongly narcotic. Readily ignited by static electricity.   | 1159   |
| –      | T7                                 | TP1                | F-E, S-C               | Category B              | SGG18<br>SG35                       | Aqueous solution of a flammable gas with an ammonia-like odour. Flashpoint for 60% solution in water: –32°C c.c. Explosive limits: 2.8% to 14.4%. Boiling point for 60% solution in water: 36°C. Flashpoint for 25% solution in water: 0°C c.c. Miscible with water. Harmful by inhalation. Causes burns to skin, eyes and mucous membranes. Reacts violently with acids.                    | 1160   |
| –      | T4                                 | TP1                | F-E, S-D               | Category B              | –                                   | Colourless liquid. Immiscible with water. Flashpoint: 18°C c.c.  | 1161   |
| –      | T10                                | TP2<br>TP7<br>TP13 | F-E, S-C               | Category B<br>SW2       | –                                   | Colourless liquid with a pungent odour. Flashpoint: –9°C c.c. Explosive limits: 1.4% to 9.5%. Immiscible with water. Reacts with water to form a complex mixture of dimethylsiloxanes and evolves hydrogen chloride, a toxic and corrosive gas. Harmful by inhalation. Causes burns to skin, eyes and mucous membranes.  | 1162   |
| –      | T20                                | TP2<br>TP13        | F-E, S-C               | Category D<br>SW2       | SGG18<br>SG5<br>SG8<br>SG13<br>SG35 | Colourless liquid with an ammonia-like odour. Flashpoint: –18°C c.c. Explosive limits: 2% to 95%. Miscible with water, generating heat. Reacts violently with acids. Highly toxic if swallowed, by skin contact or by inhalation. Causes burns to skin, eyes and mucous membranes. May react dangerously with oxidizing substances.  | 1163   |
| –      | T7                                 | TP2                | F-E, S-D               | Category E<br>SW2       | –                                   | Colourless liquid with a disagreeable odour. Flashpoint: –37°C c.c. Explosive limits: 2.2% to 19.7%. Boiling point: 37°C. Immiscible with water. When involved in a fire, evolves toxic gases. Narcotic in high concentrations.  | 1164   |
| –      | T4                                 | TP1                | F-E, S-D               | Category B              | –                                   | Colourless liquid with an ether-like odour. Flashpoint: 12°C c.c. Explosive limits: 2% to 22%. Miscible with water. Harmful by inhalation.   | 1165   |

Part 3 – Dangerous Goods List, special provisions and exceptions

Chapter 3.2 – Dangerous Goods List

| UN No. | Proper shipping name (PSN)   | Class or division | Subsidiary hazard(s) | Packing group  | Special provisions | Limited and excepted quantity provisions |                     | Packing      |              | IBC           |               |
|--------|--|-------------------|----------------------|----------------|--------------------|--|---------------------|--------------|--------------|---------------|---------------|
|        |  |                   |                      |                |                    | Limited quantities                       | Excepted quantities | Instructions | Provisions   | Instructions  | Provisions    |
| (1)    | (2)<br>3.1.2   | (3)<br>2.0        | (4)<br>2.0           | (5)<br>2.0.1.3 | (6)<br>3.3         | (7a)<br>3.4                              | (7b)<br>3.5         | (8)<br>4.1.4 | (9)<br>4.1.4 | (10)<br>4.1.4 | (11)<br>4.1.4 |
| 1166   | DIOXOLANE  | 3                 | –                    | II             | –                  | 1 L                                      | E2                  | P001         | –            | IBC02         | –             |
| 1167   | DIVINYL ETHER, STABILIZED  | 3                 | –                    | I              | 386                | 0  | E3                  | P001         | –            | –             | –             |
| 1170   | ETHANOL (ETHYL ALCOHOL) or ETHANOL SOLUTION (ETHYL ALCOHOL SOLUTION) | 3                 | –                    | II             | 144                | 1 L                                      | E2                  | P001         | –            | IBC02         | –             |
| 1170   | ETHANOL (ETHYL ALCOHOL) or ETHANOL SOLUTION (ETHYL ALCOHOL SOLUTION) | 3                 | –                    | III            | 144<br>223         | 5 L                                      | E1                  | P001<br>LP01 | –            | IBC03         | –             |
| 1171   | ETHYLENE GLYCOL MONOETHYL ETHER                                      | 3                 | –                    | III            | –                  | 5 L                                      | E1                  | P001<br>LP01 | –            | IBC03         | –             |
| 1172   | ETHYLENE GLYCOL MONOETHYL ETHER ACETATE                              | 3                 | –                    | III            | –                  | 5 L                                      | E1                  | P001<br>LP01 | –            | IBC03         | –             |
| 1173   | ETHYL ACETATE  | 3                 | –                    | II             | –                  | 1 L                                      | E2                  | P001         | –            | IBC02         | –             |
| 1175   | ETHYLBENZENE   | 3                 | –                    | II             | –                  | 1 L                                      | E2                  | P001         | –            | IBC02         | –             |
| 1176   | ETHYL BORATE   | 3                 | –                    | II             | –                  | 1 L                                      | E2                  | P001         | –            | IBC02         | –             |
| 1177   | 2-ETHYLBUTYL ACETATE   | 3                 | –                    | III            | –                  | 5 L                                      | E1                  | P001<br>LP01 | –            | IBC03         | –             |
| 1178   | 2-ETHYLBUTYRALDEHYDE   | 3                 | –                    | II             | –                  | 1 L                                      | E2                  | P001         | –            | IBC02         | –             |
| 1179   | ETHYL BUTYL ETHER  | 3                 | –                    | II             | –                  | 1 L                                      | E2                  | P001         | –            | IBC02         | –             |
| 1180   | ETHYL BUTYRATE   | 3                 | –                    | III            | –                  | 5 L                                      | E1                  | P001<br>LP01 | –            | IBC03         | –             |
| 1181   | ETHYL CHLOROACETATE  | 6.1               | 3                    | II             | –                  | 100 mL                                   | E4                  | P001         | –            | IBC02         | –             |
| 1182   | ETHYL CHLOROFORMATE  | 6.1               | 3/8                  | I              | 354                | 0  | E0                  | P602         | –            | –             | –             |
| 1183   | ETHYLDICHLOROSILANE  | 4.3               | 3/8                  | I              | –                  | 0  | E0                  | P401         | PP31         | –             | –             |
| 1184   | ETHYLENE DICHLORIDE  | 3                 | 6.1                  | II             | –                  | 1 L                                      | E2                  | P001         | –            | IBC02         | –             |
| 1185   | ETHYLENEIMINE, STABILIZED  | 6.1               | 3                    | I              | 354<br>386         | 0  | E0                  | P601         | –            | –             | –             |

| UN No. | Portable tanks and bulk containers |                    | EmS                    | Stowage and handling     | Segregation  | Properties and observations   | UN No. |
|--------|------------------------------------|--------------------|------------------------|--------------------------|--|---|--------|
|        | Tank instructions                  | Provisions         |                        |                          |  |   |        |
| (12)   | (13)<br>4.2.5<br>4.3               | (14)<br>4.2.5      | (15)<br>5.4.3.4<br>7.8 | (16a)<br>7.1<br>7.3–7.7  | (16b)<br>7.2–7.7   | (17)  | (18)   |
| –      | T4                                 | TP1                | F-E, S-D               | Category B<br>SW2        | –  | Colourless liquid. Flashpoint: 2°C c.c. Miscible with water. Harmful by inhalation.   | 1166   |
| –      | T11                                | TP2                | F-E, S-D               | Category E<br>SW1<br>SW2 | –  | Colourless, clear liquid with a characteristic odour. Flashpoint: –30°C c.c. Explosive limits: 1.7% to 27%. Boiling point: 30°C. Immiscible with water. In the presence of oxygen or on long standing or exposure to sunlight, unstable peroxides sometimes form; these may explode spontaneously or when heated. Strongly narcotic. Readily ignited by static electricity. | 1167   |
| –      | T4                                 | TP1                | F-E, S-D               | Category A               | –  | Colourless, volatile liquids. Pure ETHANOL: flashpoint 13°C c.c. Explosive limits: 3.3% to 19%. Miscible with water.  | 1170   |
| –      | T2                                 | TP1                | F-E, S-D               | Category A               | –  | See entry above.  | 1170   |
| –      | T2                                 | TP1                | F-E, S-D               | Category A               | –  | Colourless liquid. Flashpoint: 40°C c.c. Explosive limits: 1.7% to 15.6%. Miscible with water.  | 1171   |
| –      | T2                                 | TP1                | F-E, S-D               | Category A               | –  | Colourless liquid. Flashpoint: 51°C c.c. Explosive limits: 1.7% to 10.1%. Partially miscible with water.  | 1172   |
| –      | T4                                 | TP1                | F-E, S-D               | Category B               | –  | Colourless liquid with a fragrant odour. Flashpoint: –4°C c.c. Explosive limits: 2.18% to 11.5%. Immiscible with water.   | 1173   |
| –      | T4                                 | TP1                | F-E, S-D               | Category B               | –  | Colourless liquid with an aromatic odour. Flashpoint: 22°C c.c. Explosive limits: 1% to 6.7%. Immiscible with water.  | 1175   |
| –      | T4                                 | TP1                | F-E, S-D               | Category B               | –  | Colourless liquid. Flashpoint: 11°C c.c. Immiscible with water.   | 1176   |
| –      | T2                                 | TP1                | F-E, S-D               | Category A               | –  | Colourless liquid. Flashpoint: 54°C o.c. Immiscible with water.   | 1177   |
| –      | T4                                 | TP1                | F-E, S-D               | Category B               | –  | Colourless liquid. Flashpoint: 11°C c.c. Explosive limits: 1.2% to 7.7%. Immiscible with water.   | 1178   |
| –      | T4                                 | TP1                | F-E, S-D               | Category B               | –  | Colourless liquid. Flashpoint: –1°C c.c. Immiscible with water.   | 1179   |
| –      | T2                                 | TP1                | F-E, S-D               | Category A               | –  | Colourless, volatile liquid with a pineapple-like odour. Flashpoint: 26°C c.c. Immiscible with water.   | 1180   |
| –      | T7                                 | TP2                | F-E, S-D               | Category A               | –  | Colourless, flammable liquid with a pungent and fruity odour. Flashpoint: 54°C c.c. Immiscible with water. When heated, evolves toxic and corrosive fumes. Toxic if swallowed, by skin contact or by inhalation.  | 1181   |
| –      | T20                                | TP2<br>TP13        | F-E, S-C               | Category D<br>SW2        | SGG1<br>SG5<br>SG8<br>SG36<br>SG49                         | Colourless liquid. Flashpoint: 16°C c.c. Reacts and decomposes with water or heat, evolving hydrogen chloride, an irritating and corrosive gas apparent as white fumes. In the presence of moisture, highly corrosive to most metals. Highly toxic if swallowed, by skin contact or by inhalation. Causes burns to skin, eyes and mucous membranes.                         | 1182   |
| –      | T14                                | TP2<br>TP7<br>TP13 | F-G, S-O               | Category D<br>SW2<br>H1  | SGG1<br>SG5<br>SG8<br>SG13<br>SG25<br>SG26<br>SG36<br>SG49 | Colourless, very volatile liquid with a pungent odour. Flashpoint: –1°C c.c. Immiscible with water. Reacts violently with water or steam to produce heat which may lead to self-ignition; toxic and corrosive fumes will be evolved. May react vigorously in contact with oxidizing substances. Causes burns to skin, eyes and mucous membranes.                            | 1183   |
| –      | T7                                 | TP1                | F-E, S-D               | Category B<br>SW2        | SGG10  | Colourless liquid with a chloroform-like odour. Flashpoint: 13°C c.c. Explosive limits: 6.2% to 15.9%. Immiscible with water. Toxic by inhalation. Irritating to skin, eyes and mucous membranes.   | 1184   |
| –      | T22                                | TP2<br>TP13        | F-E, S-D               | Category D<br>SW1<br>SW2 | –  | Colourless oily flammable liquid with a pungent ammonia-like odour. Flashpoint: –13°C c.c. Boiling point: 55°C. Explosive limits: 3.6% to 6.0%. Miscible with water. Highly toxic if swallowed, by skin contact or by inhalation.   | 1185   |

Part 3 – Dangerous Goods List, special provisions and exceptions

Chapter 3.2 – Dangerous Goods List

| UN No. | Proper shipping name (PSN)  | Class or division | Subsidiary hazard(s) | Packing group  | Special provisions | Limited and excepted quantity provisions |                     | Packing      |              | IBC           |               |
|--------|---|-------------------|----------------------|----------------|--------------------|--|---------------------|--------------|--------------|---------------|---------------|
|        |   |                   |                      |                |                    | Limited quantities                       | Excepted quantities | Instructions | Provisions   | Instructions  | Provisions    |
| (1)    | (2)<br>3.1.2  | (3)<br>2.0        | (4)<br>2.0           | (5)<br>2.0.1.3 | (6)<br>3.3         | (7a)<br>3.4                              | (7b)<br>3.5         | (8)<br>4.1.4 | (9)<br>4.1.4 | (10)<br>4.1.4 | (11)<br>4.1.4 |
| 1188   | ETHYLENE GLYCOL MONOMETHYL ETHER                                      | 3                 | –                    | III            | –                  | 5 L                                      | E1                  | P001<br>LP01 | –            | IBC03         | –             |
| 1189   | ETHYLENE GLYCOL MONOMETHYL ETHER ACETATE                              | 3                 | –                    | III            | –                  | 5 L                                      | E1                  | P001<br>LP01 | –            | IBC03         | –             |
| 1190   | ETHYL FORMATE   | 3                 | –                    | II             | –                  | 1 L                                      | E2                  | P001         | –            | IBC02         | –             |
| 1191   | OCTYL ALDEHYDES   | 3                 | –                    | III            | –                  | 5 L                                      | E1                  | P001<br>LP01 | –            | IBC03         | –             |
| 1192   | ETHYL LACTATE   | 3                 | –                    | III            | –                  | 5 L                                      | E1                  | P001<br>LP01 | –            | IBC03         | –             |
| 1193   | ETHYL METHYL KETONE (METHYL ETHYL KETONE)                             | 3                 | –                    | II             | –                  | 1 L                                      | E2                  | P001         | –            | IBC02         | –             |
| 1194   | ETHYL NITRITE SOLUTION  | 3                 | 6.1                  | I              | 900                | 0  | E0                  | P001         | –            | –             | –             |
| 1195   | ETHYL PROPIONATE  | 3                 | –                    | II             | –                  | 1 L                                      | E2                  | P001         | –            | IBC02         | –             |
| 1196   | ETHYLTRICHLOROSILANE  | 3                 | 8                    | II             | –                  | 0  | E0                  | P010         | –            | –             | –             |
| 1197   | EXTRACTS, LIQUID, for flavour or aroma                                | 3                 | –                    | II             | –                  | 5 L                                      | E2                  | P001         | –            | IBC02         | –             |
| 1197   | EXTRACTS, LIQUID, for flavour or aroma                                | 3                 | –                    | III            | 223<br>955         | 5 L                                      | E1                  | P001<br>LP01 | –            | IBC03         | –             |
| 1198   | FORMALDEHYDE SOLUTION, FLAMMABLE                                      | 3                 | 8                    | III            | –                  | 5 L                                      | E0                  | P001         | –            | IBC03         | –             |
| 1199   | FURALDEHYDES  | 6.1               | 3                    | II             | –                  | 100 mL                                   | E4                  | P001         | –            | IBC02         | –             |
| 1201   | FUSEL OIL   | 3                 | –                    | II             | –                  | 1 L                                      | E2                  | P001         | –            | IBC02         | –             |
| 1201   | FUSEL OIL   | 3                 | –                    | III            | 223<br>955         | 5 L                                      | E1                  | P001<br>LP01 | –            | IBC03         | –             |
| 1202   | GAS OIL or DIESEL FUEL or HEATING OIL, LIGHT                          | 3                 | –                    | III            | –                  | 5 L                                      | E1                  | P001<br>LP01 | –            | IBC03         | –             |
| 1203   | MOTOR SPIRIT or GASOLINE or PETROL                                    | 3                 | –                    | II             | 243                | 1 L                                      | E2                  | P001         | –            | IBC02         | –             |
| △ 1204 | NITROGLYCERIN SOLUTION IN ALCOHOL with not more than 1% nitroglycerin | 3                 | –                    | II             | 28                 | 1 L                                      | E0                  | P001         | PP5          | IBC02         | –             |
| 1206   | HEPTANES  | 3                 | –<br>P               | II             | –                  | 1 L                                      | E2                  | P001         | –            | IBC02         | –             |

| UN No. | Portable tanks and bulk containers |                    | EmS                    | Stowage and handling    | Segregation      | Properties and observations   | UN No. |
|--------|------------------------------------|--------------------|------------------------|-------------------------|------------------|---|--------|
|        | Tank instructions                  | Provisions         |                        |                         |                  |   |        |
| (12)   | (13)<br>4.2.5<br>4.3               | (14)<br>4.2.5      | (15)<br>5.4.3.4<br>7.8 | (16a)<br>7.1<br>7.3–7.7 | (16b)<br>7.2–7.7 | (17)  | (18)   |
| –      | T2                                 | TP1                | F-E, S-D               | Category A              | –                | Colourless liquid. Flashpoint: 38°C c.c. Explosive limits: 1.8% to 20%. Miscible with water.  | 1188   |
| –      | T2                                 | TP1                | F-E, S-D               | Category A              | –                | Colourless liquid with a characteristic odour. Flashpoint: 44°C c.c. Explosive limits: 1.7% to 8.2%. Miscible with water.   | 1189   |
| –      | T4                                 | TP1                | F-E, S-D               | Category E              | –                | Colourless liquid with a pleasant aromatic odour. Flashpoint: –20°C c.c. Explosive limits: 3.5% to 16.5%. Boiling point: 54°C. Immiscible with water.   | 1190   |
| –      | T2                                 | TP1                | F-E, S-D               | Category A              | –                | Colourless liquids with a characteristic odour. Flashpoint: 44°C to 52°C c.c. Explosive limits: 0.9% to 7.2%. Immiscible with water.  | 1191   |
| –      | T2                                 | TP1                | F-E, S-D               | Category A              | –                | Colourless liquid. Flashpoint: 46°C c.c. Explosive limits: 1.5% to 11.4%. Miscible with water.  | 1192   |
| –      | T4                                 | TP1                | F-E, S-D               | Category B              | –                | Colourless liquid. Flashpoint: –1°C c.c. Explosive limits: 1.8% to 11.5%. Miscible with water.  | 1193   |
| –      | –                                  | –                  | F-E, S-D               | Category D<br>SW2       | –                | Alcoholic solution of ethyl nitrite. Extremely volatile, with an aromatic, ethereal odour. Explosive limits of the pure product: 3% to 50%. Boiling point of pure product: 17°C. Miscible or partially miscible with water. Decomposes under exposure to air, light, water or heat to evolve toxic nitrous fumes. Toxic if swallowed, by skin contact or by inhalation. Inhalation of ethyl nitrite vapours, even in small quantities, rapidly affects the heart and can be dangerous. Transport of ETHYL NITRITE pure is prohibited. | 1194   |
| –      | T4                                 | TP1                | F-E, S-D               | Category B              | –                | Colourless liquid with a pineapple-like odour. Flashpoint: 12°C c.c. Explosive limits: 1.8% to 11%. Immiscible with water.  | 1195   |
| –      | T10                                | TP2<br>TP7<br>TP13 | F-E, S-C               | Category B<br>SW2       | –                | Colourless liquid with a pungent odour. Flashpoint: 14°C c.c. Readily hydrolysed by moisture, evolving hydrogen chloride, an irritating and corrosive gas apparent as white fumes. Causes burns to skin and eyes. Irritating to mucous membranes.   | 1196   |
| –      | T4                                 | TP1<br>TP8         | F-E, S-D               | Category B              | –                | Usually consist of alcoholic solutions. Miscibility with water depends upon the composition.  | 1197   |
| –      | T2                                 | TP1                | F-E, S-D               | Category A              | –                | See entry above.  | 1197   |
| –      | T4                                 | TP1                | F-E, S-C               | Category A<br>SW2       | –                | Colourless liquids with a pungent odour. Flashpoint: 32–60°C c.c. Miscible with water. Irritating to skin, eyes and mucous membranes.   | 1198   |
| –      | T7                                 | TP2                | F-E, S-D               | Category A              | –                | Colourless or reddish-brown, mobile liquids with a pungent odour. Miscible with water. Explosive limits for 2-FURALDEHYDE: 2.1% to 19.3%. Flashpoints: 2-FURALDEHYDE 60°C c.c., 3-FURALDEHYDE 48°C c.c. Toxic if swallowed, by skin contact or by inhalation.   | 1199   |
| –      | T4                                 | TP1                | F-E, S-D               | Category B              | –                | Colourless, oily liquid with a disagreeable odour. A mixture consisting of amyl alcohols. Immiscible with water.  | 1201   |
| –      | T2                                 | TP1                | F-E, S-D               | Category A              | –                | See entry above.  | 1201   |
| –      | T2                                 | TP1                | F-E, S-E               | Category A              | –                | Immiscible with water.  | 1202   |
| –      | T4                                 | TP1                | F-E, S-E               | Category E              | –                | Immiscible with water.  | 1203   |
| –      | –                                  | –                  | F-E, S-D               | Category B              | –                | Immiscible with water. Ignites readily. When involved in a fire, evolves toxic nitrous fumes. Not explosive in this state but damage to, or leakage from, a package may allow solvent to evaporate and thus leave the nitroglycerin in an explosive state.  | △ 1204 |
| –      | T4                                 | TP2                | F-E, S-D               | Category B              | –                | Colourless, volatile liquids. Explosive limits: 1.1% to 6.7%. n-HEPTANE: flashpoint –4°C c.c. Immiscible with water. Irritating to skin, eyes and mucous membranes.   | 1206   |



Part 3 – Dangerous Goods List, special provisions and exceptions

Chapter 3.2 – Dangerous Goods List

| UN No. | Proper shipping name (PSN)   | Class or division | Subsidiary hazard(s) | Packing group  | Special provisions       | Limited and excepted quantity provisions |                     | Packing      |              | IBC           |               |
|--------|--|-------------------|----------------------|----------------|--------------------------|--|---------------------|--------------|--------------|---------------|---------------|
|        |  |                   |                      |                |                          | Limited quantities                       | Excepted quantities | Instructions | Provisions   | Instructions  | Provisions    |
| (1)    | (2)<br>3.1.2   | (3)<br>2.0        | (4)<br>2.0           | (5)<br>2.0.1.3 | (6)<br>3.3               | (7a)<br>3.4                              | (7b)<br>3.5         | (8)<br>4.1.4 | (9)<br>4.1.4 | (10)<br>4.1.4 | (11)<br>4.1.4 |
| 1207   | HEXALDEHYDE  | 3                 | –                    | III            | –                        | 5 L                                      | E1                  | P001<br>LP01 | –            | IBC03         | –             |
| 1208   | HEXANES  | 3                 | –<br>P               | II             | –                        | 1 L                                      | E2                  | P001         | –            | IBC02         | –             |
| 1210   | PRINTING INK, flammable or PRINTING INK RELATED MATERIAL (including printing ink thinning or reducing compound), flammable | 3                 | –                    | I              | 163<br>367               | 500 mL                                   | E3                  | P001         | –            | –             | –             |
| 1210   | PRINTING INK, flammable or PRINTING INK RELATED MATERIAL (including printing ink thinning or reducing compound), flammable | 3                 | –                    | II             | 163<br>367               | 5 L                                      | E2                  | P001         | PP1          | IBC02         | –             |
| 1210   | PRINTING INK, flammable or PRINTING INK RELATED MATERIAL (including printing ink thinning or reducing compound), flammable | 3                 | –                    | III            | 163<br>223<br>367<br>955 | 5 L                                      | E1                  | P001<br>LP01 | PP1          | IBC03         | –             |
| 1212   | ISOBUTANOL (ISOBUTYL ALCOHOL)  | 3                 | –                    | III            | –                        | 5 L                                      | E1                  | P001<br>LP01 | –            | IBC03         | –             |
| 1213   | ISOBUTYL ACETATE   | 3                 | –                    | II             | –                        | 1 L                                      | E2                  | P001         | –            | IBC02         | –             |
| 1214   | ISOBUTYLAMINE  | 3                 | 8                    | II             | –                        | 1 L                                      | E2                  | P001         | –            | IBC02         | –             |
| 1216   | ISOOCTENES   | 3                 | –                    | II             | –                        | 1 L                                      | E2                  | P001         | –            | IBC02         | –             |
| 1218   | ISOPRENE, STABILIZED   | 3                 | –<br>P               | I              | 386                      | 0  | E3                  | P001         | –            | –             | –             |
| 1219   | ISOPROPANOL (ISOPROPYL ALCOHOL)  | 3                 | –                    | II             | –                        | 1 L                                      | E2                  | P001         | –            | IBC02         | –             |
| 1220   | ISOPROPYL ACETATE  | 3                 | –                    | II             | –                        | 1 L                                      | E2                  | P001         | –            | IBC02         | –             |
| 1221   | ISOPROPYLAMINE   | 3                 | 8                    | I              | –                        | 0  | E0                  | P001         | –            | –             | –             |
| 1222   | ISOPROPYL NITRATE  | 3                 | –                    | II             | 26                       | 1 L                                      | E2                  | P001         | –            | –             | –             |
| 1223   | KEROSENE   | 3                 | –                    | III            | –                        | 5 L                                      | E1                  | P001<br>LP01 | –            | IBC03         | –             |
| 1224   | KETONES, LIQUID, N.O.S.  | 3                 | –                    | II             | 274                      | 1 L                                      | E2                  | P001         | –            | IBC02         | –             |
| 1224   | KETONES, LIQUID, N.O.S.  | 3                 | –                    | III            | 223<br>274               | 5 L                                      | E1                  | P001<br>LP01 | –            | IBC03         | –             |
| 1228   | MERCAPTANS, LIQUID, FLAMMABLE, TOXIC, N.O.S. or MERCAPTAN MIXTURE, LIQUID, FLAMMABLE, TOXIC, N.O.S.                        | 3                 | 6.1                  | II             | 274                      | 1 L                                      | E0                  | P001         | –            | IBC02         | –             |

| UN No. | Portable tanks and bulk containers |                    | EmS                    | Stowage and handling    | Segregation      | Properties and observations  | UN No. |
|--------|------------------------------------|--------------------|------------------------|-------------------------|------------------|--|--------|
|        | Tank instructions                  | Provisions         |                        |                         |                  |  |        |
| (12)   | (13)<br>4.2.5<br>4.3               | (14)<br>4.2.5      | (15)<br>5.4.3.4<br>7.8 | (16a)<br>7.1<br>7.3–7.7 | (16b)<br>7.2–7.7 | (17)   | (18)   |
| –      | T2                                 | TP1                | F-E, S-D               | Category A              | –                | Colourless liquid with a pungent odour. Flashpoint: 32°C c.c. Immiscible with water.   | 1207   |
| –      | T4                                 | TP2                | F-E, S-D               | Category E              | –                | Colourless, volatile liquids with a faint odour. Explosive limits: 1.1% to 7.5%. n-HEXANE: flashpoint –22°C c.c., boiling point 69°C. NEOHEXANE: flashpoint –48°C c.c., boiling point 50°C. Immiscible with water. Slightly irritating to skin, eyes and mucous membranes. | 1208   |
| –      | T11                                | TP1<br>TP8         | F-E, S-D               | Category E              | –                | Fluid or viscous liquid containing colouring matter in solution or suspension. Miscibility with water depends upon the solvent.  | 1210   |
| –      | T4                                 | TP1<br>TP8         | F-E, S-D               | Category B              | –                | See entry above.   | 1210   |
| –      | T2                                 | TP1                | F-E, S-D               | Category A              | –                | See entry above.   | 1210   |
| –      | T2                                 | TP1                | F-E, S-D               | Category A              | –                | Colourless liquid with a sweet odour. Flashpoint: 28°C c.c. Explosive limits: 1.2% to 10.9%. Partially miscible with water.  | 1212   |
| –      | T4                                 | TP1                | F-E, S-D               | Category B              | –                | Colourless liquid with a pineapple-like odour. Flashpoint: 18°C c.c. Explosive limits: 1.3% to 10.5%. Immiscible with water.   | 1213   |
| –      | T7                                 | TP1                | F-E, S-C               | Category B<br>SW2       | SG35             | Colourless liquid. Flashpoint: –9°C c.c. Explosive limits: 3.4% to 9%. Miscible with water. Harmful by inhalation. Causes burns to skin and eyes. Irritating to mucous membranes.  | 1214   |
| –      | T4                                 | TP1                | F-E, S-D               | Category B              | –                | Colourless liquids. Immiscible with water.   | 1216   |
| –      | T11                                | TP2                | F-E, S-D               | Category D<br>SW1       | –                | Colourless, volatile liquid. Flashpoint: –48°C c.c. Explosive limits: 1.5% to 9.7%. Boiling point: 34°C. Immiscible with water.  | 1218   |
| –      | T4                                 | TP1                | F-E, S-D               | Category B              | –                | Colourless, mobile liquid. Flashpoint: 12°C c.c. Explosive limits: 2% to 12%. Miscible with water.   | 1219   |
| –      | T4                                 | TP1                | F-E, S-D               | Category B              | –                | Colourless liquid with an aromatic odour. Flashpoint: 11°C c.c. Explosive limits: 1.8% to 7.8%. Immiscible with water.   | 1220   |
| –      | T11                                | TP2                | F-E, S-C               | Category E<br>SW2       | SG35             | Colourless, volatile liquid with an ammonia-like odour. Flashpoint: –37°C c.c. Explosive limits: 2.3% to 10.4%. Boiling point: 32°C. Miscible with water. Harmful if swallowed. Causes burns to skin, eyes and mucous membranes.   | 1221   |
| –      | –                                  | –                  | F-E, S-D               | Category D              | –                | Colourless liquid. Flashpoint: 12°C c.c. Explosive limits: up to 100%. Immiscible with water. May explode on heating. Harmful by inhalation.   | 1222   |
| –      | T2                                 | TP2                | F-E, S-E               | Category A              | –                | Immiscible with water.   | 1223   |
| –      | T7                                 | TP1<br>TP8<br>TP28 | F-E, S-D               | Category B              | –                | –  | 1224   |
| –      | T4                                 | TP1<br>TP29        | F-E, S-D               | Category A              | –                | –  | 1224   |
| –      | T11                                | TP2<br>TP27        | F-E, S-D               | Category B<br>SW2       | SG50<br>SG57     | Colourless to yellow liquids with a garlic odour. Immiscible with water. Toxic if swallowed, by skin contact or by inhalation.   | 1228   |

Part 3 – Dangerous Goods List, special provisions and exceptions

Chapter 3.2 – Dangerous Goods List

| UN No. | Proper shipping name (PSN)  | Class or division | Subsidiary hazard(s) | Packing group  | Special provisions | Limited and excepted quantity provisions |                     | Packing      |              | IBC           |               |
|--------|---|-------------------|----------------------|----------------|--------------------|--|---------------------|--------------|--------------|---------------|---------------|
|        |   |                   |                      |                |                    | Limited quantities                       | Excepted quantities | Instructions | Provisions   | Instructions  | Provisions    |
| (1)    | (2)<br>3.1.2  | (3)<br>2.0        | (4)<br>2.0           | (5)<br>2.0.1.3 | (6)<br>3.3         | (7a)<br>3.4                              | (7b)<br>3.5         | (8)<br>4.1.4 | (9)<br>4.1.4 | (10)<br>4.1.4 | (11)<br>4.1.4 |
| 1228   | MERCAPTANS, LIQUID, FLAMMABLE, TOXIC, N.O.S. or MERCAPTAN MIXTURE, LIQUID, FLAMMABLE, TOXIC, N.O.S. | 3                 | 6.1                  | III            | 223<br>274         | 5 L                                      | E1                  | P001         | -            | IBC03         | -             |
| 1229   | MESITYL OXIDE   | 3                 | -                    | III            | -                  | 5 L                                      | E1                  | P001<br>LP01 | -            | IBC03         | -             |
| 1230   | METHANOL  | 3                 | 6.1                  | II             | 279                | 1 L                                      | E2                  | P001         | -            | IBC02         | -             |
| 1231   | METHYL ACETATE  | 3                 | -                    | II             | -                  | 1 L                                      | E2                  | P001         | -            | IBC02         | -             |
| 1233   | METHYLAMYL ACETATE  | 3                 | -                    | III            | -                  | 5 L                                      | E1                  | P001<br>LP01 | -            | IBC03         | -             |
| 1234   | METHYLAL  | 3                 | -                    | II             | -                  | 1 L                                      | E2                  | P001         | -            | IBC02         | B8            |
| 1235   | METHYLAMINE, AQUEOUS SOLUTION   | 3                 | 8                    | II             | -                  | 1 L                                      | E2                  | P001         | -            | IBC02         | -             |
| 1237   | METHYL BUTYRATE   | 3                 | -                    | II             | -                  | 1 L                                      | E2                  | P001         | -            | IBC02         | -             |
| 1238   | METHYL CHLOROFORMATE  | 6.1               | 3/8                  | I              | 354                | 0  | E0                  | P602         | -            | -             | -             |
| 1239   | METHYL CHLOROMETHYL ETHER   | 6.1               | 3                    | I              | 354                | 0  | E0                  | P602         | -            | -             | -             |
| 1242   | METHYLDICHLOROSILANE  | 4.3               | 3/8                  | I              | -                  | 0  | E0                  | P401         | PP31         | -             | -             |
| 1243   | METHYL FORMATE  | 3                 | -                    | I              | -                  | 0  | E3                  | P001         | -            | -             | -             |
| 1244   | METHYLHYDRAZINE   | 6.1               | 3/8                  | I              | 354                | 0  | E0                  | P602         | -            | -             | -             |
| 1245   | METHYL ISOBUTYL KETONE  | 3                 | -                    | II             | -                  | 1 L                                      | E2                  | P001         | -            | IBC02         | -             |
| 1246   | METHYL ISOPROPENYL KETONE, STABILIZED   | 3                 | -                    | II             | 386                | 1 L                                      | E2                  | P001         | -            | IBC02         | -             |
| 1247   | METHYL METHACRYLATE MONOMER, STABILIZED   | 3                 | -                    | II             | 386                | 1 L                                      | E2                  | P001         | -            | IBC02         | -             |
| 1248   | METHYL PROPIONATE   | 3                 | -                    | II             | -                  | 1 L                                      | E2                  | P001         | -            | IBC02         | -             |

| UN No. | Portable tanks and bulk containers |                    | EmS                    | Stowage and handling     | Segregation  | Properties and observations   | UN No. |
|--------|------------------------------------|--------------------|------------------------|--------------------------|--|---|--------|
|        | Tank instructions                  | Provisions         |                        |                          |  |   |        |
| (12)   | (13)<br>4.2.5<br>4.3               | (14)<br>4.2.5      | (15)<br>5.4.3.4<br>7.8 | (16a)<br>7.1<br>7.3-7.7  | (16b)<br>7.2-7.7   | (17)  | (18)   |
| -      | T7                                 | TP1<br>TP28        | F-E, S-D               | Category B<br>SW2        | SG50<br>SG57   | Colourless to yellow liquids with a garlic odour. Immiscible with water. Toxic if swallowed, by skin contact or by inhalation.  | 1228   |
| -      | T2                                 | TP1                | F-E, S-D               | Category A               | -  | Colourless, oily liquid with a sweet odour. Flashpoint: 32°C c.c. Miscible with water.  | 1229   |
| -      | T7                                 | TP2                | F-E, S-D               | Category B<br>SW2        | -  | Colourless, volatile liquid. Flashpoint: 12°C c.c. Explosive limits: 6% to 36.5%. Miscible with water. Toxic if swallowed; may cause blindness. Avoid skin contact.   | 1230   |
| -      | T4                                 | TP1                | F-E, S-D               | Category B               | -  | Colourless, volatile liquid with a fragrant odour. Flashpoint: -10°C c.c. Explosive limits: 3% to 16%. Miscible with water.   | 1231   |
| -      | T2                                 | TP1                | F-E, S-D               | Category A               | -  | Colourless liquid. Flashpoint: 43°C o.c. Immiscible with water.   | 1233   |
| -      | T7                                 | TP2                | F-E, S-D               | Category E               | -  | Colourless, volatile liquid with a chloroform-like odour. Flashpoint: -28°C c.c. Explosive limits: 3.6% to 12.6%. Boiling point: 42°C. Miscible with water. Irritating to skin, eyes and mucous membranes.  | 1234   |
| -      | T7                                 | TP1                | F-E, S-C               | Category E               | SGG18<br>SG35<br>SG54                                      | Aqueous solution of a flammable gas having an ammonia-like odour. Explosive limits: 5% to 20.7% (pure product). Boiling point: -7°C (pure product). Commercial product is a 40% solution with: boiling point 48°C, flashpoint -13°C c.c. Miscible with water. May react explosively with mercury. Causes burns to skin, eyes and mucous membranes.  | 1235   |
| -      | T4                                 | TP1                | F-E, S-D               | Category B               | -  | Colourless liquid. Flashpoint: 14°C c.c. Immiscible with water.   | 1237   |
| -      | T22                                | TP2<br>TP13        | F-E, S-C               | Category D<br>SW2        | SGG1<br>SG5<br>SG8<br>SG36<br>SG49                         | Colourless liquid. Flashpoint: 5°C c.c. Immiscible with water. Highly toxic if swallowed, by skin contact or by inhalation. Causes burns to skin, eyes and mucous membranes.  | 1238   |
| -      | T22                                | TP2<br>TP13        | F-E, S-D               | Category D<br>SW2        | -  | Colourless liquid. Flashpoint: below -18°C c.c. Immiscible with water. Highly toxic if swallowed, by skin contact or by inhalation.   | 1239   |
| -      | T14                                | TP2<br>TP7<br>TP13 | F-G, S-O               | Category D<br>SW2<br>H1  | SGG1<br>SG5<br>SG8<br>SG13<br>SG25<br>SG26<br>SG36<br>SG49 | Colourless, very volatile liquid with a pungent odour. Flashpoint: -26°C c.c. Explosive limits: 4.5% to 70%. Boiling point: 41°C. Immiscible with water. Reacts violently with water or steam to produce heat which may lead to self-ignition; toxic and corrosive fumes will be evolved. May react vigorously in contact with oxidizing substances. Causes burns to skin, eyes and mucous membranes. | 1242   |
| -      | T11                                | TP2                | F-E, S-D               | Category E               | -  | Colourless liquid with an agreeable odour. Flashpoint: -32°C c.c. Explosive limits: 5% to 22.7%. Boiling point: 32°C. Miscible with water.  | 1243   |
| -      | T22                                | TP2<br>TP13        | F-E, S-C               | Category D<br>SW2        | SGG18<br>SG5<br>SG8<br>SG13<br>SG35                        | Colourless liquid with an ammonia-like odour. Flashpoint: 20°C c.c. Explosive limits: 2.5% to 98%. Miscible with water. Reacts violently with acids. May react dangerously with oxidizing substances. Highly toxic if swallowed, by skin contact or by inhalation. Causes burns to skin, eyes and mucous membranes.   | 1244   |
| -      | T4                                 | TP1                | F-E, S-D               | Category B               | -  | Colourless liquid with a pleasant odour. Flashpoint: 14°C c.c. Explosive limits: 1.4% to 7.5%. Immiscible with water.   | 1245   |
| -      | T4                                 | TP1                | F-E, S-D               | Category C<br>SW1        | -  | Colourless liquid with a pleasant odour. Explosive limits: 1.8% to 9%. Immiscible with water.   | 1246   |
| -      | T4                                 | TP1                | F-E, S-D               | Category C<br>SW1<br>SW2 | -  | Colourless, volatile liquid. Flashpoint: 8°C c.c. Explosive limits: 1.5% to 11.6%. Immiscible with water. Irritating to skin, eyes and mucous membranes.  | 1247   |
| -      | T4                                 | TP1                | F-E, S-D               | Category B               | -  | Colourless liquid. Flashpoint: -2°C c.c. Explosive limits: 2.4% to 13%. Immiscible with water.  | 1248   |

Part 3 – Dangerous Goods List, special provisions and exceptions

Chapter 3.2 – Dangerous Goods List

| UN No. | Proper shipping name (PSN)   | Class or division | Subsidiary hazard(s) | Packing group  | Special provisions       | Limited and excepted quantity provisions |                     | Packing      |              | IBC           |               |
|--------|--|-------------------|----------------------|----------------|--------------------------|--|---------------------|--------------|--------------|---------------|---------------|
|        |  |                   |                      |                |                          | Limited quantities                       | Excepted quantities | Instructions | Provisions   | Instructions  | Provisions    |
| (1)    | (2)<br>3.1.2   | (3)<br>2.0        | (4)<br>2.0           | (5)<br>2.0.1.3 | (6)<br>3.3               | (7a)<br>3.4                              | (7b)<br>3.5         | (8)<br>4.1.4 | (9)<br>4.1.4 | (10)<br>4.1.4 | (11)<br>4.1.4 |
| 1249   | METHYL PROPYL KETONE   | 3                 | –                    | II             | –                        | 1 L                                      | E2                  | P001         | –            | IBC02         | –             |
| 1250   | METHYLTRICHLOROSILANE  | 3                 | 8                    | II             | –                        | 0  | E0                  | P010         | –            | –             | –             |
| 1251   | METHYL VINYL KETONE, STABILIZED  | 6.1               | 3/8                  | I              | 354<br>386               | 0  | E0                  | P601         | –            | –             | –             |
| 1259   | NICKEL CARBONYL  | 6.1               | 3<br>P               | I              | –                        | 0  | E0                  | P601         | –            | –             | –             |
| 1261   | NITROMETHANE   | 3                 | –                    | II             | 26                       | 1 L                                      | E0                  | P001         | –            | –             | –             |
| 1262   | OCTANES  | 3                 | –<br>P               | II             | –                        | 1 L                                      | E2                  | P001         | –            | IBC02         | –             |
| 1263   | PAINT (including paint, lacquer, enamel, stain, shellac, varnish, polish, liquid filler and liquid lacquer base) or PAINT RELATED MATERIAL (including paint thinning or reducing compound) | 3                 | –                    | I              | 163<br>367               | 500 mL                                   | E3                  | P001         | –            | –             | –             |
| 1263   | PAINT (including paint, lacquer, enamel, stain, shellac, varnish, polish, liquid filler and liquid lacquer base) or PAINT RELATED MATERIAL (including paint thinning or reducing compound) | 3                 | –                    | II             | 163<br>367               | 5 L                                      | E2                  | P001         | PP1          | IBC02         | –             |
| 1263   | PAINT (including paint, lacquer, enamel, stain, shellac, varnish, polish, liquid filler and liquid lacquer base) or PAINT RELATED MATERIAL (including paint thinning or reducing compound) | 3                 | –                    | III            | 163<br>223<br>367<br>955 | 5 L                                      | E1                  | P001<br>LP01 | PP1          | IBC03         | –             |
| 1264   | PARALDEHYDE  | 3                 | –                    | III            | –                        | 5 L                                      | E1                  | P001<br>LP01 | –            | IBC03         | –             |
| 1265   | PENTANES, liquid   | 3                 | –                    | I              | –                        | 0  | E3                  | P001         | –            | –             | –             |
| 1265   | PENTANES, liquid   | 3                 | –                    | II             | –                        | 1 L                                      | E2                  | P001         | –            | IBC02         | –             |
| 1266   | PERFUMERY PRODUCTS with flammable solvents   | 3                 | –                    | II             | 163                      | 5 L                                      | E2                  | P001         | –            | IBC02         | –             |
| 1266   | PERFUMERY PRODUCTS with flammable solvents   | 3                 | –                    | III            | 163<br>223<br>904<br>955 | 5 L                                      | E1                  | P001<br>LP01 | –            | IBC03         | –             |

| UN No. | Portable tanks and bulk containers |                    | EmS                    | Stowage and handling     | Segregation          | Properties and observations   | UN No. |
|--------|------------------------------------|--------------------|------------------------|--------------------------|----------------------|---|--------|
|        | Tank instructions                  | Provisions         |                        |                          |                      |   |        |
| (12)   | (13)<br>4.2.5<br>4.3               | (14)<br>4.2.5      | (15)<br>5.4.3.4<br>7.8 | (16a)<br>7.1<br>7.3–7.7  | (16b)<br>7.2–7.7     | (17)  | (18)   |
| –      | T4                                 | TP1                | F-E, S-D               | Category B               | –                    | Colourless liquid. Flashpoint: 7°C c.c. Explosive limits: 1.5% to 8.2%. Immiscible with water.  | 1249   |
| –      | T10                                | TP2<br>TP7<br>TP13 | F-E, S-C               | Category B<br>SW2        | SGG1<br>SG36<br>SG49 | Colourless liquid with a pungent odour. Flashpoint: 8°C o.c. Explosive limits: 5.1% to 20%. Immiscible with water. Readily hydrolysed by moisture, evolving hydrogen chloride, an irritating and corrosive gas apparent as white fumes. In the presence of moisture, corrosive to most metals. Causes burns to skin and eyes. Irritating to mucous membranes. | 1250   |
| –      | T22                                | TP2<br>TP13        | F-E, S-C               | Category D<br>SW1<br>SW2 | SG5<br>SG8           | Colourless liquid with a pungent odour. Miscible with water. Explosive limits: 2.1% to 15.6%. Flashpoint: –7°C c.c. Highly toxic if swallowed, by skin contact or by inhalation. Causes burns to skin, eyes and mucous membranes.   | 1251   |
| –      | –                                  | –                  | F-E, S-D               | Category D<br>SW2        | SG63                 | Colourless or yellow, volatile, flammable liquid. Flashpoint: below –20°C c.c. Oxidizes in air and explodes at a temperature of 60°C. Lower explosive limit: 2.0%. Immiscible with water. Highly toxic if swallowed, by skin contact or by inhalation.  | 1259   |
| –      | –                                  | –                  | F-E, S-D               | Category A               | –                    | Colourless liquid. Flashpoint: 35°C c.c. Explosive limits: 7.1% to 63%. Miscible with water. Fire and explosion hazard if package is ruptured.  | 1261   |
| –      | T4                                 | TP2                | F-E, S-E               | Category B               | –                    | Colourless liquids. Explosive limits: 1% to 6.5%. ISOCTANE: flashpoint –12°C c.c. <i>n</i> -OCTANE: flashpoint 13°C c.c. Immiscible with water.   | 1262   |
| –      | T11                                | TP1<br>TP8<br>TP27 | F-E, S-E               | Category E               | –                    | Miscibility with water depends upon the composition.  | 1263   |
| –      | T4                                 | TP1<br>TP8<br>TP28 | F-E, S-E               | Category B               | –                    | See entry above.  | 1263   |
| –      | T2                                 | TP1<br>TP29        | F-E, S-E               | Category A               | –                    | See entry above.  | 1263   |
| –      | T2                                 | TP1                | F-E, S-D               | Category A               | –                    | Colourless liquid. Flashpoint: 27°C c.c. Lower explosive limit: 1.3%. Miscible with water.  | 1264   |
| –      | T11                                | TP2                | F-E, S-D               | Category E               | –                    | Colourless liquids with a paraffin-like odour. Explosive limits: 1.4% to 8%. ISOPENTANE (2-METHYLBUTANE): boiling point 28°C. Immiscible with water. Slightly irritating to skin, eyes and mucous membranes. Narcotic in high concentrations.   | 1265   |
| –      | T4                                 | TP1                | F-E, S-D               | Category E               | –                    | See entry above. <i>normal</i> -PENTANE: boiling point 36°C.  | 1265   |
| –      | T4                                 | TP1<br>TP8         | F-E, S-D               | Category B               | –                    | Miscibility with water depends upon the composition.  | 1266   |
| –      | T2                                 | TP1                | F-E, S-D               | Category A               | –                    | See entry above.  | 1266   |



Part 3 – Dangerous Goods List, special provisions and exceptions

Chapter 3.2 – Dangerous Goods List

| UN No. | Proper shipping name (PSN)                                  | Class or division | Subsidiary hazard(s) | Packing group  | Special provisions | Limited and excepted quantity provisions |                     | Packing      |              | IBC           |               |
|--------|---|-------------------|----------------------|----------------|--------------------|--|---------------------|--------------|--------------|---------------|---------------|
|        |   |                   |                      |                |                    | Limited quantities                       | Excepted quantities | Instructions | Provisions   | Instructions  | Provisions    |
| (1)    | (2)<br>3.1.2  | (3)<br>2.0        | (4)<br>2.0           | (5)<br>2.0.1.3 | (6)<br>3.3         | (7a)<br>3.4                              | (7b)<br>3.5         | (8)<br>4.1.4 | (9)<br>4.1.4 | (10)<br>4.1.4 | (11)<br>4.1.4 |
| 1267   | PETROLEUM CRUDE OIL   | 3                 | –                    | I              | 357                | 500 mL                                   | E3                  | P001         | –            | –             | –             |
| 1267   | PETROLEUM CRUDE OIL   | 3                 | –                    | II             | 357                | 1 L                                      | E2                  | P001         | –            | IBC02         | –             |
| 1267   | PETROLEUM CRUDE OIL   | 3                 | –                    | III            | 223<br>357         | 5 L                                      | E1                  | P001<br>LP01 | –            | IBC03         | –             |
| 1268   | PETROLEUM DISTILLATES, N.O.S. or PETROLEUM PRODUCTS, N.O.S. | 3                 | –                    | I              | –                  | 500 mL                                   | E3                  | P001         | –            | –             | –             |
| 1268   | PETROLEUM DISTILLATES, N.O.S. or PETROLEUM PRODUCTS, N.O.S. | 3                 | –                    | II             | –                  | 1 L                                      | E2                  | P001         | –            | IBC02         | –             |
| 1268   | PETROLEUM DISTILLATES, N.O.S. or PETROLEUM PRODUCTS, N.O.S. | 3                 | –                    | III            | 223<br>955         | 5 L                                      | E1                  | P001<br>LP01 | –            | IBC03         | –             |
| 1272   | PINE OIL  | 3                 | –<br>P               | III            | –                  | 5 L                                      | E1                  | P001<br>LP01 | –            | IBC03         | –             |
| 1274   | n-PROPANOL (PROPYL ALCOHOL, NORMAL)                         | 3                 | –                    | II             | –                  | 1 L                                      | E2                  | P001         | –            | IBC02         | –             |
| 1274   | n-PROPANOL (PROPYL ALCOHOL, NORMAL)                         | 3                 | –                    | III            | 223                | 5 L                                      | E1                  | P001<br>LP01 | –            | IBC03         | –             |
| 1275   | PROPIONALDEHYDE   | 3                 | –                    | II             | –                  | 1 L                                      | E2                  | P001         | –            | IBC02         | –             |
| 1276   | n-PROPYL ACETATE  | 3                 | –                    | II             | –                  | 1 L                                      | E2                  | P001         | –            | IBC02         | –             |
| 1277   | PROPYLAMINE   | 3                 | 8                    | II             | –                  | 1 L                                      | E2                  | P001         | –            | IBC02         | –             |
| 1278   | 1-CHLOROPROPANE   | 3                 | –                    | II             | –                  | 1 L                                      | E0                  | P001         | –            | IBC02         | B8            |
| 1279   | 1,2-DICHLOROPROPANE   | 3                 | –                    | II             | –                  | 1 L                                      | E2                  | P001         | –            | IBC02         | –             |
| 1280   | PROPYLENE OXIDE   | 3                 | –                    | I              | –                  | 0  | E3                  | P001         | –            | –             | –             |
| 1281   | PROPYL FORMATES   | 3                 | –                    | II             | –                  | 1 L                                      | E2                  | P001         | –            | IBC02         | –             |
| 1282   | PYRIDINE  | 3                 | –                    | II             | –                  | 1 L                                      | E2                  | P001         | –            | IBC02         | –             |
| 1286   | ROSIN OIL   | 3                 | –                    | II             | –                  | 1 L                                      | E2                  | P001         | –            | IBC02         | –             |
| 1286   | ROSIN OIL   | 3                 | –                    | III            | 223                | 5 L                                      | E1                  | P001<br>LP01 | –            | IBC03         | –             |
| 1287   | RUBBER SOLUTION   | 3                 | –                    | II             | –                  | 5 L                                      | E2                  | P001         | –            | IBC02         | –             |
| 1287   | RUBBER SOLUTION   | 3                 | –                    | III            | 223<br>955         | 5 L                                      | E1                  | P001<br>LP01 | –            | IBC03         | –             |
| 1288   | SHALE OIL   | 3                 | –                    | II             | –                  | 1 L                                      | E2                  | P001         | –            | IBC02         | –             |

| UN No. | Portable tanks and bulk containers |                    | EmS                    | Stowage and handling    | Segregation      | Properties and observations   | UN No. |
|--------|------------------------------------|--------------------|------------------------|-------------------------|------------------|---|--------|
|        | Tank instructions                  | Provisions         |                        |                         |                  |   |        |
| (12)   | (13)<br>4.2.5<br>4.3               | (14)<br>4.2.5      | (15)<br>5.4.3.4<br>7.8 | (16a)<br>7.1<br>7.3–7.7 | (16b)<br>7.2–7.7 | (17)  | (18)   |
| –      | T11                                | TP1<br>TP8         | F-E, S-E               | Category E              | –                | Immiscible with water.  | 1267   |
| –      | T4                                 | TP1<br>TP8         | F-E, S-E               | Category B              | –                | See entry above.  | 1267   |
| –      | T2                                 | TP1                | F-E, S-E               | Category A              | –                | See entry above.  | 1267   |
| –      | T11                                | TP1<br>TP8         | F-E, S-E               | Category E              | –                | Immiscible with water.  | 1268   |
| –      | T7                                 | TP1<br>TP8<br>TP28 | F-E, S-E               | Category B              | –                | See entry above.  | 1268   |
| –      | T4                                 | TP1<br>TP29        | F-E, S-E               | Category A              | –                | See entry above.  | 1268   |
| –      | T2                                 | TP2                | F-E, S-E               | Category A              | –                | Volatile oils with characteristic odours. Flashpoint: 57°C to 60°C c.c. Immiscible with water.  | 1272   |
| –      | T4                                 | TP1                | F-E, S-D               | Category B              | –                | Colourless liquid. Explosive limits: 2% to 12%. Flashpoint: 15°C to 23°C c.c. Miscible with water.  | 1274   |
| –      | T2                                 | TP1                | F-E, S-D               | Category A              | –                | See entry above. Flashpoint: 23°C to 26°C c.c.  | 1274   |
| –      | T7                                 | TP1                | F-E, S-D               | Category E              | –                | Colourless liquid with a pungent odour. Flashpoint: below –18°C c.c. Explosive limits: 2.3% to 21%. Boiling point: 49°C. Miscible with water. Irritating to skin, eyes and mucous membranes.    | 1275   |
| –      | T4                                 | TP1                | F-E, S-D               | Category B              | –                | Colourless, clear liquid with a pleasant odour. Flashpoint: 10°C c.c. Explosive limits: 1.8% to 8%. Immiscible with water.  | 1276   |
| –      | T7                                 | TP1                | F-E, S-C               | Category E<br>SW2       | SG35             | Colourless liquid. Flashpoint: below –18°C c.c. Explosive limits: 2% to 10.4%. Boiling point: 48°C. Miscible with water. Harmful if swallowed. Causes burns to skin, eyes and mucous membranes. | 1277   |
| –      | T7                                 | TP2                | F-E, S-D               | Category E              | SGG10            | Colourless liquid with a chloroform-like odour. Flashpoint: –18°C c.c. Explosive limits: 2.6% to 10.5%. Boiling point: 47°C. Immiscible with water.   | 1278   |
| –      | T4                                 | TP1                | F-E, S-D               | Category B              | SGG10            | Colourless liquid. Flashpoint: 15°C c.c. Immiscible with water. Harmful by inhalation. Irritating to skin and eyes.   | 1279   |
| –      | T11                                | TP2<br>TP7         | F-E, S-D               | Category E<br>SW2       | –                | Colourless, volatile liquid with an ether-like odour. Flashpoint: below –18°C c.c. Explosive limits: 2% to 22%. Boiling point: 34°C. Partially miscible with water.                             | 1280   |
| –      | T4                                 | TP1                | F-E, S-D               | Category B              | –                | Colourless liquids with a pleasant odour. Explosive limits: 2.4% to 7.8%. Miscibility with water depends upon the composition. Irritating to skin, eyes and mucous membranes.                   | 1281   |
| –      | T4                                 | TP2                | F-E, S-D               | Category B<br>SW2       | –                | Colourless or slightly yellow liquid with a pungent odour. Flashpoint: 17°C c.c. Explosive limits: 1.8% to 12.4%. Miscible with water. Harmful by inhalation.                                   | 1282   |
| –      | T4                                 | TP1                | F-E, S-E               | Category B              | –                | Colourless to brown viscous liquid. Immiscible with water.  | 1286   |
| –      | T2                                 | TP1                | F-E, S-E               | Category A              | –                | See entry above.  | 1286   |
| –      | T4                                 | TP1<br>TP8         | F-E, S-D               | Category B              | –                | Miscibility with water depends upon the composition.  | 1287   |
| –      | T2                                 | TP1                | F-E, S-D               | Category A              | –                | See entry above.  | 1287   |
| –      | T4                                 | TP1<br>TP8         | F-E, S-E               | Category B              | –                | Immiscible with water.  | 1288   |

Part 3 – Dangerous Goods List, special provisions and exceptions

Chapter 3.2 – Dangerous Goods List

| UN No. | Proper shipping name (PSN)  | Class or division | Subsidiary hazard(s) | Packing group  | Special provisions | Limited and excepted quantity provisions |                     | Packing      |              | IBC           |               |
|--------|---|-------------------|----------------------|----------------|--------------------|--|---------------------|--------------|--------------|---------------|---------------|
|        |   |                   |                      |                |                    | Limited quantities                       | Excepted quantities | Instructions | Provisions   | Instructions  | Provisions    |
| (1)    | (2)<br>3.1.2  | (3)<br>2.0        | (4)<br>2.0           | (5)<br>2.0.1.3 | (6)<br>3.3         | (7a)<br>3.4                              | (7b)<br>3.5         | (8)<br>4.1.4 | (9)<br>4.1.4 | (10)<br>4.1.4 | (11)<br>4.1.4 |
| 1288   | SHALE OIL   | 3                 | –                    | III            | 223                | 5 L                                      | E1                  | P001<br>LP01 | –            | IBC03         | –             |
| 1289   | SODIUM METHYLATE SOLUTION in alcohol  | 3                 | 8                    | II             | –                  | 1 L                                      | E2                  | P001         | –            | IBC02         | –             |
| 1289   | SODIUM METHYLATE SOLUTION in alcohol  | 3                 | 8                    | III            | 223                | 5 L                                      | E1                  | P001         | –            | IBC03         | –             |
| 1292   | TETRAETHYL SILICATE   | 3                 | –                    | III            | –                  | 5 L                                      | E1                  | P001<br>LP01 | –            | IBC03         | –             |
| 1293   | TINCTURES, MEDICINAL  | 3                 | –                    | II             | –                  | 1 L                                      | E2                  | P001         | –            | IBC02         | –             |
| 1293   | TINCTURES, MEDICINAL  | 3                 | –                    | III            | 904<br>955         | 5 L                                      | E1                  | P001<br>LP01 | –            | IBC03         | –             |
| 1294   | TOLUENE   | 3                 | –                    | II             | –                  | 1 L                                      | E2                  | P001         | –            | IBC02         | –             |
| 1295   | TRICHLOROSILANE   | 4.3               | 3/8                  | I              | –                  | 0  | E0                  | P401         | PP31         | –             | –             |
| 1296   | TRIETHYLAMINE   | 3                 | 8                    | II             | –                  | 1 L                                      | E2                  | P001         | –            | IBC02         | –             |
| 1297   | TRIMETHYLAMINE, AQUEOUS SOLUTION, not more than 50% trimethylamine, by mass | 3                 | 8                    | I              | –                  | 0  | E0                  | P001         | –            | –             | –             |
| 1297   | TRIMETHYLAMINE, AQUEOUS SOLUTION, not more than 50% trimethylamine, by mass | 3                 | 8                    | II             | –                  | 1 L                                      | E2                  | P001         | –            | IBC02         | –             |
| 1297   | TRIMETHYLAMINE, AQUEOUS SOLUTION, not more than 50% trimethylamine, by mass | 3                 | 8                    | III            | 223                | 5 L                                      | E1                  | P001         | –            | IBC03         | –             |
| 1298   | TRIMETHYLCHLOROSILANE   | 3                 | 8                    | II             | –                  | 0  | E0                  | P010         | –            | –             | –             |
| 1299   | TURPENTINE  | 3                 | –<br>P               | III            | –                  | 5 L                                      | E1                  | P001<br>LP01 | –            | IBC03         | –             |
| 1300   | TURPENTINE SUBSTITUTE   | 3                 | –                    | II             | –                  | 1 L                                      | E2                  | P001         | –            | IBC02         | –             |
| 1300   | TURPENTINE SUBSTITUTE   | 3                 | –                    | III            | 223                | 5 L                                      | E1                  | P001<br>LP01 | –            | IBC03         | –             |
| 1301   | VINYL ACETATE, STABILIZED   | 3                 | –                    | II             | 386                | 1 L                                      | E2                  | P001         | –            | IBC02         | –             |
| 1302   | VINYL ETHYL ETHER, STABILIZED   | 3                 | –                    | I              | 386                | 0  | E3                  | P001         | –            | –             | –             |

| UN No. | Portable tanks and bulk containers |                    | EmS                    | Stowage and handling    | Segregation  | Properties and observations   | UN No. |
|--------|------------------------------------|--------------------|------------------------|-------------------------|--|---|--------|
|        | Tank instructions                  | Provisions         |                        |                         |  |   |        |
| (12)   | (13)<br>4.2.5<br>4.3               | (14)<br>4.2.5      | (15)<br>5.4.3.4<br>7.8 | (16a)<br>7.1<br>7.3–7.7 | (16b)<br>7.2–7.7   | (17)  | (18)   |
| –      | T2                                 | TP1                | F-E, S-E               | Category A              | –  | Immiscible with water.  | 1288   |
| –      | T7                                 | TP1<br>TP8         | F-E, S-C               | Category B              | SGG18<br>SG35  | Reacts violently with water. Causes burns to skin, eyes and mucous membranes.   | 1289   |
| –      | T4                                 | TP1                | F-E, S-C               | Category A              | SGG18<br>SG35  | See entry above. Irritating to skin, eyes and mucous membranes.   | 1289   |
| –      | T2                                 | TP1                | F-E, S-D               | Category A.             | –  | Colourless liquid. Flashpoint: 37°C c.c. Explosive limits: 1.3% to 23%. Immiscible with water.  | 1292   |
| –      | T4                                 | TP1<br>TP8         | F-E, S-D               | Category B              | –  | Miscibility with water depends upon the composition.  | 1293   |
| –      | T2                                 | TP1                | F-E, S-D               | Category A              | –  | See entry above.  | 1293   |
| –      | T4                                 | TP1                | F-E, S-D               | Category B              | –  | Colourless liquid with a benzene-like odour. Flashpoint: 7°C c.c. Explosive limits: 1.27% to 7%. Immiscible with water.   | 1294   |
| –      | T14                                | TP2<br>TP7<br>TP13 | F-G, S-O               | Category D<br>SW2<br>H1 | SGG1<br>SG5<br>SG8<br>SG13<br>SG25<br>SG26<br>SG36<br>SG49<br>SG72 | Colourless, very volatile, flammable and corrosive liquid. Flashpoint: below –50°C. Explosive limits: 1.2% to 90.5%. Boiling point: 32°C. Reacts with water or steam to produce heat, which may lead to self-ignition; toxic and corrosive fumes will be evolved. May react vigorously in contact with oxidizing substances. Causes burns to skin, eyes and mucous membranes.                   | 1295   |
| –      | T7                                 | TP1                | F-E, S-C               | Category B<br>SW2       | SG35   | Colourless liquid with a strong ammonia-like odour. Flashpoint: –11°C c.c. Explosive limits: 1.2% to 8%. Miscible with water. Harmful by inhalation. Causes burns to skin and eyes. Irritating to mucous membranes.   | 1296   |
| –      | T11                                | TP1                | F-E, S-C               | Category D<br>SW2       | SG35<br>SG54   | Aqueous solution of a flammable gas with an ammonia-like odour. Flashpoint depending on percentage of dissolved gas. May react explosively with mercury. Miscible with water. An aqueous solution of 45% TRIMETHYLAMINE, by mass, has a flashpoint of –45°C c.c. and a boiling point of 30°C (applicable to PG I only). Harmful by inhalation. Causes burns to skin, eyes and mucous membranes. | 1297   |
| –      | T7                                 | TP1                | F-E, S-C               | Category B<br>SW2       | SG35<br>SG54   | See entry above.  | 1297   |
| –      | T7                                 | TP1                | F-E, S-C               | Category A<br>SW2       | SG35<br>SG54   | See entry above. Irritating to skin, eyes and mucous membranes.   | 1297   |
| –      | T10                                | TP2<br>TP7<br>TP13 | F-E, S-C               | Category E<br>SW2       | SGG1<br>SG36<br>SG49   | Colourless liquid. Flashpoint: below –18°C c.c. Explosive limits: 1.8% to 6%. Boiling point: 57°C. Immiscible with water. Readily hydrolysed by moisture, evolving hydrogen chloride, a toxic and corrosive gas. Causes burns to skin, eyes and mucous membranes.   | 1298   |
| –      | T2                                 | TP2                | F-E, S-E               | Category A              | –  | Colourless liquid. Flashpoint: 35°C c.c. Mixture of resin and volatile oils. Immiscible with water.   | 1299   |
| –      | T4                                 | TP1                | F-E, S-E               | Category B              | –  | Immiscible with water.  | 1300   |
| –      | T2                                 | TP1                | F-E, S-E               | Category A              | –  | See entry above.  | 1300   |
| –      | T4                                 | TP1                | F-E, S-D               | Category C<br>SW1       | –  | Colourless to light yellow liquid. Flashpoint: –8°C c.c. Explosive limits: 2.6% to 14%. Immiscible with water.  | 1301   |
| –      | T11                                | TP2                | F-E, S-D               | Category D<br>SW1       | –  | Colourless liquid. Flashpoint: below –18°C c.c. Explosive limits: 1.7% to 28%. Boiling point: 33°C. Immiscible with water. Extremely reactive; may polymerize.  | 1302   |

Part 3 – Dangerous Goods List, special provisions and exceptions

Chapter 3.2 – Dangerous Goods List

| UN No. | Proper shipping name (PSN)                                     | Class or division | Subsidiary hazard(s) | Packing group  | Special provisions | Limited and excepted quantity provisions |                     | Packing      |                             | IBC           |               |
|--------|--|-------------------|----------------------|----------------|--------------------|--|---------------------|--------------|-----------------------------|---------------|---------------|
|        |  |                   |                      |                |                    | Limited quantities                       | Excepted quantities | Instructions | Provisions                  | Instructions  | Provisions    |
| (1)    | (2)<br>3.1.2   | (3)<br>2.0        | (4)<br>2.0           | (5)<br>2.0.1.3 | (6)<br>3.3         | (7a)<br>3.4                              | (7b)<br>3.5         | (8)<br>4.1.4 | (9)<br>4.1.4                | (10)<br>4.1.4 | (11)<br>4.1.4 |
| 1303   | VINYLDENE CHLORIDE, STABILIZED                                 | 3                 | -<br>P               | I              | 386                | 0  | E3                  | P001         | -                           | -             | -             |
| 1304   | VINYL ISOBUTYL ETHER, STABILIZED                               | 3                 | -                    | II             | 386                | 1 L                                      | E2                  | P001         | -                           | IBC02         | -             |
| 1305   | VINYLTRICHLOROSILANE   | 3                 | 8                    | II             | -                  | 0  | E0                  | P010         | -                           | -             | -             |
| 1306   | WOOD PRESERVATIVES, LIQUID                                     | 3                 | -                    | II             | -                  | 5 L                                      | E2                  | P001         | -                           | IBC02         | -             |
| 1306   | WOOD PRESERVATIVES, LIQUID                                     | 3                 | -                    | III            | 223<br>955         | 5 L                                      | E1                  | P001<br>LP01 | -                           | IBC03         | -             |
| 1307   | XYLENES  | 3                 | -                    | II             | -                  | 1 L                                      | E2                  | P001         | -                           | IBC02         | -             |
| 1307   | XYLENES  | 3                 | -                    | III            | 223                | 5 L                                      | E1                  | P001<br>LP01 | -                           | IBC03         | -             |
| 1308   | ZIRCONIUM, SUSPENDED IN A FLAMMABLE LIQUID                     | 3                 | -                    | I              | -                  | 0  | E0                  | P001         | PP33                        | -             | -             |
| 1308   | ZIRCONIUM, SUSPENDED IN A FLAMMABLE LIQUID                     | 3                 | -                    | II             | -                  | 1 L                                      | E2                  | P001         | PP33                        | -             | -             |
| 1308   | ZIRCONIUM, SUSPENDED IN A FLAMMABLE LIQUID                     | 3                 | -                    | III            | 223                | 5 L                                      | E1                  | P001         | -                           | -             | -             |
| 1309   | ALUMINIUM POWDER, COATED                                       | 4.1               | -                    | II             | -                  | 1 kg                                     | E2                  | P002         | PP38<br>PP100               | IBC08         | B4<br>B21     |
| 1309   | ALUMINIUM POWDER, COATED                                       | 4.1               | -                    | III            | 223                | 5 kg                                     | E1                  | P002<br>LP02 | PP11<br>PP38<br>PP100<br>L3 | IBC08         | B4            |
| 1310   | AMMONIUM PICRATE, WETTED with not less than 10% water, by mass | 4.1               | -                    | I              | 28                 | 0  | E0                  | P406         | PP26<br>PP31                | -             | -             |
| 1312   | BORNEOL  | 4.1               | -                    | III            | -                  | 5 kg                                     | E1                  | P002<br>LP02 | -                           | IBC08         | B3            |
| 1313   | CALCIUM RESINATE   | 4.1               | -                    | III            | -                  | 5 kg                                     | E1                  | P002         | -                           | IBC06         | -             |
| 1314   | CALCIUM RESINATE, FUSED  | 4.1               | -                    | III            | -                  | 5 kg                                     | E1                  | P002         | -                           | IBC04         | -             |
| 1318   | COBALT RESINATE, PRECIPITATED                                  | 4.1               | -                    | III            | -                  | 5 kg                                     | E1                  | P002         | -                           | IBC06         | -             |

| UN No. | Portable tanks and bulk containers |                    | EmS                    | Stowage and handling     | Segregation   | Properties and observations  | UN No. |
|--------|------------------------------------|--------------------|------------------------|--------------------------|---|--|--------|
|        | Tank instructions                  | Provisions         |                        |                          |   |  |        |
| (12)   | (13)<br>4.2.5<br>4.3               | (14)<br>4.2.5      | (15)<br>5.4.3.4<br>7.8 | (16a)<br>7.1<br>7.3-7.7  | (16b)<br>7.2-7.7  | (17)   | (18)   |
| -      | T12                                | TP2<br>TP7         | F-E, S-D               | Category D<br>SW1<br>SW2 | SGG10   | Colourless to straw-coloured, volatile liquid with a sweet odour. Flashpoint: -28°C c.c. Explosive limits: 6.5% to 15.5%. Boiling point: 32°C. Immiscible with water.  | 1303   |
| -      | T4                                 | TP1                | F-E, S-D               | Category C<br>SW1        | -   | Colourless liquid. Flashpoint: -9°C o.c. Immiscible with water.  | 1304   |
| -      | T10                                | TP2<br>TP7<br>TP13 | F-E, S-C               | Category B<br>SW2        | SGG1<br>SG36<br>SG49  | Colourless, pale yellow or pink liquid with a pungent odour. Flashpoint: 11°C c.c. Lower explosive limit: 3%. Readily hydrolysed by moisture, evolving hydrogen chloride, an irritating and corrosive gas apparent as white fumes. Immiscible with water. In the presence of moisture, corrosive to most metals.   | 1305   |
| -      | T4                                 | TP1<br>TP8         | F-E, S-D               | Category B               | -   | Miscibility with water depends upon the composition. Harmful by inhalation.  | 1306   |
| -      | T2                                 | TP1                | F-E, S-D               | Category A               | -   | See entry above.   | 1306   |
| -      | T4                                 | TP1                | F-E, S-D               | Category B               | -   | Colourless liquids. Flashpoint: 17°C to 23°C c.c. Explosive limits: 1.1% to 7%. Immiscible with water.   | 1307   |
| -      | T2                                 | TP1                | F-E, S-D               | Category A               | -   | See entry above. Flashpoint: 23°C to 30°C c.c.   | 1307   |
| -      | -                                  | -                  | F-E, S-D               | Category D               | -   | Finely divided zirconium metal in a flammable liquid. Immiscible with water. Spillage is liable to self-ignition.  | 1308   |
| -      | -                                  | -                  | F-E, S-D               | Category B               | -   | See entry above.   | 1308   |
| -      | -                                  | -                  | F-E, S-D               | Category B               | -   | See entry above.   | 1308   |
| -      | T3                                 | TP33               | F-G, S-G               | Category A<br>H1         | SGG15<br>SG17<br>SG25<br>SG26<br>SG32<br>SG35<br>SG36<br>SG52 | If uncoated, it possesses the property of evolving hydrogen gas when in contact with water, especially seawater; if treated with oil or wax, it does not at ordinary temperatures. Reacts readily with acids and caustic alkalis, evolving hydrogen, a flammable gas. Reacts readily with iron oxide, producing a thermite effect. May form explosive mixtures with oxidizing substances. In the event of breakage of receptacles, the scattered powder is readily ignited by sparks or open flame and may give rise to an explosive atmosphere. | 1309   |
| -      | T1                                 | TP33               | F-G, S-G               | Category A<br>H1         | SGG15<br>SG17<br>SG25<br>SG26<br>SG32<br>SG35<br>SG36<br>SG52 | See entry above.   | 1309   |
| -      | -                                  | -                  | F-B, S-J               | Category D               | SGG2<br>SG7<br>SG30   | Desensitized explosive. Substance in pure form consists of yellow crystals. Explosive and sensitive to friction in the dry state. May form extremely sensitive compounds with heavy metals or their salts. Harmful if swallowed or by skin contact.  | 1310   |
| -      | T1                                 | TP33               | F-A, S-I               | Category A               | -   | White, translucent lumps. Camphor-like odour. Insoluble in water. Harmful by ingestion.  | 1312   |
| -      | T1                                 | TP33               | F-A, S-I               | Category A               | -   | Yellowish-white, amorphous powder or lumps. Insoluble in water. Liable to spontaneous heating. Irritating to skin and mucous membranes.  | 1313   |
| -      | T1                                 | TP33               | F-A, S-I               | Category A               | -   | Yellowish-white, amorphous powder or lumps. Insoluble in water. Liable to spontaneous heating. Irritating to skin and mucous membranes.  | 1314   |
| -      | T1                                 | TP33               | F-A, S-I               | Category A               | -   | Dark brownish-black solid. Insoluble in water. Readily combustible; may ignite spontaneously if contaminated with vegetable fibres (such as cotton). Irritating to skin and mucous membranes.  | 1318   |

Part 3 – Dangerous Goods List, special provisions and exceptions

Chapter 3.2 – Dangerous Goods List

| UN No. | Proper shipping name (PSN)  | Class or division | Subsidiary hazard(s) | Packing group  | Special provisions      | Limited and excepted quantity provisions |                     | Packing      |              | IBC           |               |
|--------|---|-------------------|----------------------|----------------|-------------------------|--|---------------------|--------------|--------------|---------------|---------------|
|        |   |                   |                      |                |                         | Limited quantities                       | Excepted quantities | Instructions | Provisions   | Instructions  | Provisions    |
| (1)    | (2)<br>3.1.2  | (3)<br>2.0        | (4)<br>2.0           | (5)<br>2.0.1.3 | (6)<br>3.3              | (7a)<br>3.4                              | (7b)<br>3.5         | (8)<br>4.1.4 | (9)<br>4.1.4 | (10)<br>4.1.4 | (11)<br>4.1.4 |
| 1320   | DINITROPHENOL, WETTED with not less than 15% water, by mass   | 4.1               | 6.1<br>P             | I              | 28                      | 0  | E0                  | P406         | PP26<br>PP31 | -             | -             |
| 1321   | DINITROPHENOLATES, WETTED with not less than 15% water, by mass   | 4.1               | 6.1<br>P             | I              | 28                      | 0  | E0                  | P406         | PP26<br>PP31 | -             | -             |
| 1322   | DINITRORESORCINOL, WETTED with not less than 15% water, by mass   | 4.1               | -                    | I              | 28                      | 0  | E0                  | P406         | PP26<br>PP31 | -             | -             |
| 1323   | FERROCERIUM   | 4.1               | -                    | II             | 249                     | 1 kg                                     | E2                  | P002         | PP100        | IBC08         | B4<br>B21     |
| 1324   | FILMS, NITROCELLULOSE BASE, gelatin coated, except scrap  | 4.1               | -                    | III            | -                       | 5 kg                                     | E1                  | P002         | PP15         | -             | -             |
| 1325   | FLAMMABLE SOLID, ORGANIC, N.O.S.  | 4.1               | -                    | II             | 274                     | 1 kg                                     | E2                  | P002         | -            | IBC08         | B4<br>B21     |
| 1325   | FLAMMABLE SOLID, ORGANIC, N.O.S.  | 4.1               | -                    | III            | 223<br>274              | 5 kg                                     | E1                  | P002         | -            | IBC08         | B3            |
| 1326   | HAFNIUM POWDER, WETTED with not less than 25% water (a visible excess of water must be present)<br>(a) mechanically produced, particle size less than 53 microns;<br>(b) chemically produced, particle size less than 840 microns | 4.1               | -                    | II             | 916                     | 1 kg                                     | E2                  | P410         | PP31<br>PP40 | IBC06         | B21           |
| 1327   | HAY, STRAW or BHUSA   | 4.1               | -                    | -              | 29<br>281<br>954<br>973 | 3 kg                                     | E0                  | P003         | PP19         | IBC08         | B6            |
| 1328   | HEXAMETHYLENETETRAMINE  | 4.1               | -                    | III            | -                       | 5 kg                                     | E1                  | P002         | -            | IBC08         | B3            |
| 1330   | MANGANESE RESINATE  | 4.1               | -                    | III            | -                       | 5 kg                                     | E1                  | P002         | -            | IBC06         | -             |
| 1331   | MATCHES, "STRIKE ANYWHERE"  | 4.1               | -                    | III            | 293                     | 5 kg                                     | E0                  | P407         | PP27         | -             | -             |
| 1332   | METALDEHYDE   | 4.1               | -                    | III            | -                       | 5 kg                                     | E1                  | P002<br>LP02 | -            | IBC08         | B3            |
| 1333   | CERIUM, slabs, ingots or rods   | 4.1               | -                    | II             | -                       | 1 kg                                     | E2                  | P002         | PP100        | IBC08         | B4<br>B21     |
| 1334   | NAPHTHALENE, CRUDE or NAPHTHALENE, REFINED  | 4.1               | -<br>P               | III            | 948<br>967              | 5 kg                                     | E1                  | P002<br>LP02 | -            | IBC08         | B3            |
| 1336   | NITROGUANIDINE (PICRITE), WETTED with not less than 20% water, by mass  | 4.1               | -                    | I              | 28                      | 0  | E0                  | P406         | PP31         | -             | -             |
| 1337   | NITROSTARCH, WETTED with not less than 20% water, by mass   | 4.1               | -                    | I              | 28                      | 0  | E0                  | P406         | PP31         | -             | -             |
| 1338   | PHOSPHORUS, AMORPHOUS   | 4.1               | -                    | III            | -                       | 5 kg                                     | E1                  | P410         | -            | IBC08         | B3            |

| UN No. | Portable tanks and bulk containers |               | EmS                    | Stowage and handling    | Segregation          | Properties and observations  | UN No. |
|--------|------------------------------------|---------------|------------------------|-------------------------|----------------------|--|--------|
|        | Tank instructions                  | Provisions    |                        |                         |                      |  |        |
| (12)   | (13)<br>4.2.5<br>4.3               | (14)<br>4.2.5 | (15)<br>5.4.3.4<br>7.8 | (16a)<br>7.1<br>7.3-7.7 | (16b)<br>7.2-7.7     | (17)   | (18)   |
| -      | -                                  | -             | F-B, S-J               | Category E              | SG7<br>SG30          | Desensitized explosive. Substance when pure consists of yellow crystals. Slightly soluble in water. May form extremely sensitive compounds with heavy metals or their salts. Toxic if swallowed, by skin contact or by inhalation.   | 1320   |
| -      | -                                  | -             | F-B, S-J               | Category E              | SG7<br>SG30          | Desensitized explosives. Explosive and sensitive to friction in the dry state. May form extremely sensitive compounds with heavy metals or their salts. Toxic if swallowed, by skin contact or by inhalation.  | 1321   |
| -      | -                                  | -             | F-B, S-J               | Category E              | SG7<br>SG30          | Desensitized explosive. Explosive when dry. May form extremely sensitive compounds with heavy metals or their salts. Harmful if swallowed or by skin contact.  | 1322   |
| -      | T3                                 | TP33          | F-G, S-G               | Category A<br>H1        | SG25<br>SG26         | Alloy derived from cerium or mischmetal, with the addition of 10% to 65% iron. Emits sparks when struck.   | 1323   |
| -      | -                                  | -             | F-A, S-I               | Category D              | SG7                  | Ignites readily. When involved in a fire, evolves toxic fumes; in closed compartments, these fumes may form an explosive mixture with air.   | 1324   |
| -      | T3                                 | TP33          | F-A, S-G               | Category B              | SG72                 | -  | 1325   |
| -      | T1                                 | TP33          | F-A, S-G               | Category B              | SG72                 | -  | 1325   |
| -      | T3                                 | TP33          | F-A, S-J               | Category E              | SGG15<br>SG17        | Insoluble in water. Liable to spontaneous combustion when dry. Forms explosive mixtures with oxidizing substances.   | 1326   |
| -      | -                                  | -             | F-A, S-I               | Category A<br>SW10      | SG23                 | Ignites readily. Liable to spontaneous combustion when wet, damp or contaminated with oil. Refuse for shipment when loose, damp, wet or contaminated with oil.   | 1327   |
| -      | T1                                 | TP33          | F-A, S-G               | Category A              | -                    | White, crystalline powder. Soluble in water.   | 1328   |
| -      | T1                                 | TP33          | F-A, S-I               | Category A              | -                    | Very dark brown solid. Insoluble in water. Liable to spontaneous heating. Irritating to skin, eyes and mucous membranes.   | 1330   |
| -      | -                                  | -             | F-A, S-I               | Category B              | -                    | Ignite by friction; prepared surface is not required.  | 1331   |
| -      | T1                                 | TP33          | F-A, S-G               | Category A              | -                    | White crystals, powder or tablets. Insoluble in water. Harmful if swallowed or by dust inhalation.   | 1332   |
| -      | -                                  | -             | F-G, S-P               | Category A<br>H1        | SG17<br>SG25<br>SG26 | Contains 94-99% rare earth metals. In contact with water or moist air, evolves hydrogen, a flammable gas. Emits sparks when scratched or struck.   | 1333   |
| -      | T1<br>BK2<br>BK3                   | TP33          | F-A, S-G               | Category A<br>SW23      | -                    | Crystalline flakes or powder with a persistent odour. Evolves flammable vapours at, or below, its melting point.   | 1334   |
| -      | -                                  | -             | F-B, S-J               | Category E              | SG7<br>SG30          | Desensitized explosive. White solid. When involved in a fire, evolves toxic fumes; in closed compartments, these fumes may form an explosive mixture with air. May form extremely sensitive compounds with heavy metals or their salts.  | 1336   |
| -      | -                                  | -             | F-B, S-J               | Category D              | SG7<br>SG30          | Desensitized explosive. Orange powder. Explosive and sensitive to friction in the dry state. When involved in a fire, evolves toxic fumes; in closed compartments these fumes may form an explosive mixture with air. May form extremely sensitive compounds with heavy metals or their salts. | 1337   |
| -      | T1                                 | TP33          | F-A, S-G               | Category A              | SG17                 | Reddish-brown powder. Insoluble in water. Ignites readily by friction. When involved in a fire, evolves irritating fumes. Forms explosive mixtures with oxidizing substances. Harmful if swallowed or by dust inhalation.  | 1338   |



Part 3 – Dangerous Goods List, special provisions and exceptions

Chapter 3.2 – Dangerous Goods List

| UN No. | Proper shipping name (PSN)   | Class or division | Subsidiary hazard(s) | Packing group  | Special provisions | Limited and excepted quantity provisions |                     | Packing      |                      | IBC           |               |
|--------|--|-------------------|----------------------|----------------|--------------------|--|---------------------|--------------|----------------------|---------------|---------------|
|        |  |                   |                      |                |                    | Limited quantities                       | Excepted quantities | Instructions | Provisions           | Instructions  | Provisions    |
| (1)    | (2)<br>3.1.2   | (3)<br>2.0        | (4)<br>2.0           | (5)<br>2.0.1.3 | (6)<br>3.3         | (7a)<br>3.4                              | (7b)<br>3.5         | (8)<br>4.1.4 | (9)<br>4.1.4         | (10)<br>4.1.4 | (11)<br>4.1.4 |
| 1339   | PHOSPHORUS HEPTASULPHIDE, free from yellow or white phosphorus   | 4.1               | –                    | II             | –                  | 1 kg                                     | E2                  | P410         | PP31                 | IBC04         | –             |
| 1340   | PHOSPHORUS PENTASULPHIDE, free from yellow or white phosphorus   | 4.3               | 4.1                  | II             | –                  | 500 g                                    | E2                  | P410         | PP31<br>PP40         | IBC04         | –             |
| 1341   | PHOSPHORUS SESQUISULPHIDE, free from yellow or white phosphorus  | 4.1               | –                    | II             | –                  | 1 kg                                     | E2                  | P410         | PP31                 | IBC04         | –             |
| 1343   | PHOSPHORUS TRISULPHIDE, free from yellow or white phosphorus   | 4.1               | –                    | II             | –                  | 1 kg                                     | E2                  | P410         | PP31                 | IBC04         | –             |
| 1344   | TRINITROPHENOL (PICRIC ACID), WETTED with not less than 30% water, by mass   | 4.1               | –                    | I              | 28                 | 0  | E0                  | P406         | PP26<br>PP31         | –             | –             |
| 1345   | RUBBER SCRAP or RUBBER SHODDY, powdered or granulated, not exceeding 840 microns and rubber content exceeding 45%  | 4.1               | –                    | II             | 223<br>917         | 1 kg                                     | E2                  | P002         | –                    | IBC08         | B4<br>B21     |
| 1346   | SILICON POWDER, AMORPHOUS  | 4.1               | –                    | III            | 32                 | 5 kg                                     | E1                  | P002<br>LP02 | –                    | IBC08         | B3            |
| 1347   | SILVER PICRATE, WETTED with not less than 30% water, by mass   | 4.1               | –                    | I              | 28<br>900          | 0  | E0                  | P406         | PP25<br>PP26<br>PP31 | –             | –             |
| 1348   | SODIUM DINITRO- <i>o</i> -CRESOLATE, WETTED with not less than 15% water, by mass  | 4.1               | 6.1<br>P             | I              | 28                 | 0  | E0                  | P406         | PP26<br>PP31         | –             | –             |
| 1349   | SODIUM PICRAMATE, WETTED with not less than 20% water, by mass   | 4.1               | –                    | I              | 28                 | 0  | E0                  | P406         | PP26<br>PP31         | –             | –             |
| 1350   | SULPHUR  | 4.1               | –                    | III            | 242<br>967         | 5 kg                                     | E1                  | P002<br>LP02 | –                    | IBC08         | B3            |
| 1352   | TITANIUM POWDER, WETTED with not less than 25% water (a visible excess of water must be present)<br>(a) mechanically produced, particle size less than 53 microns;<br>(b) chemically produced, particle size less than 840 microns | 4.1               | –                    | II             | 28<br>916          | 1 kg                                     | E2                  | P410         | PP31<br>PP40         | IBC06         | B21           |

| UN No. | Portable tanks and bulk containers |               | EmS                    | Stowage and handling      | Segregation          | Properties and observations  | UN No. |
|--------|------------------------------------|---------------|------------------------|---------------------------|----------------------|--|--------|
|        | Tank instructions                  | Provisions    |                        |                           |                      |  |        |
| (12)   | (13)<br>4.2.5<br>4.3               | (14)<br>4.2.5 | (15)<br>5.4.3.4<br>7.8 | (16a)<br>7.1<br>7.3–7.7   | (16b)<br>7.2–7.7     | (17)   | (18)   |
| –      | T3                                 | TP33          | F-G, S-G               | Category B<br>H1          | SG17<br>SG25<br>SG26 | Yellow solid. Ignites readily by friction. Develops heat in contact with moist air, evolving toxic and flammable gases. Forms explosive mixtures with oxidizing substances. Harmful if swallowed or by dust inhalation.  | 1339   |
| –      | T3                                 | TP33          | F-G, S-N               | Category D<br>H1          | SG26                 | Yellow solid. Ignites readily by friction. Develops heat in contact with moist air, evolving toxic and flammable gases. Forms explosive mixtures with oxidizing substances. Harmful if swallowed or by dust inhalation.  | 1340   |
| –      | T3                                 | TP33          | F-A, S-G               | Category B                | SG17                 | Yellow solid. Ignites readily by friction. Develops heat in contact with moist air, evolving toxic and flammable gases. Forms explosive mixtures with oxidizing substances. Harmful if swallowed or by dust inhalation.  | 1341   |
| –      | T3                                 | TP33          | F-G, S-G               | Category B<br>H1          | SG17<br>SG25<br>SG26 | Yellow solid. Ignites readily by friction. Develops heat in contact with moist air, evolving toxic and flammable gases. Forms explosive mixtures with oxidizing substances. Harmful if swallowed or by dust inhalation.  | 1343   |
| –      | –                                  | –             | F-B, S-J               | Category E                | SG7<br>SG30          | Desensitized explosive. Substance in pure form consists of yellow crystals. Soluble in water. Explosive and sensitive to friction in the dry state. May form extremely sensitive compounds with heavy metals or their salts. Harmful if swallowed or by skin contact.  | 1344   |
| –      | T3                                 | TP33          | F-A, S-I               | Category A                | –                    | Liable to spontaneous heating.   | 1345   |
| –      | T1                                 | TP33          | F-A, S-G               | Category A                | SG17                 | Dark brown, non-metallic powder. Burns in air, when ignited; readily flammable when mixed with oxidizing substances.   | 1346   |
| –      | –                                  | –             | F-B, S-J               | Category D                | SGG7<br>SG7<br>SG30  | Desensitized explosive. Yellow crystals. Soluble in water. Explosive and sensitive to friction in the dry state. Harmful if swallowed or by skin contact. May form extremely sensitive compounds with heavy metals or their salts. Transport of SILVER PICRATE, dry or wetted with less than 30% water, by mass is <b>prohibited</b> .   | 1347   |
| –      | –                                  | –             | F-B, S-J               | Category E                | SG7<br>SG30          | Desensitized explosive. Substance in pure form consists of yellow powder. Explosive and sensitive to friction in the dry state. May form extremely sensitive compounds with heavy metals or their salts. When involved in a fire, evolves toxic fumes; in closed compartments, these fumes may form an explosive mixture with air. Toxic if swallowed, by skin contact or by inhalation.   | 1348   |
| –      | –                                  | –             | F-B, S-J               | Category E                | SG7<br>SG30          | Desensitized explosive. Substance in pure form consists of yellow powder. Explosive and sensitive to friction in the dry state. May form extremely sensitive compounds with heavy metals or their salts. When involved in a fire, evolves toxic fumes; in closed compartments, these fumes may form an explosive mixture with air. Harmful if swallowed or by skin contact.  | 1349   |
| –      | T1<br>BK2<br>BK3                   | TP33          | F-A, S-G               | Category A<br>SW1<br>SW23 | SG17                 | When involved in a fire, evolves toxic, very irritating and suffocating gas. The dust forms an explosive mixture with air which may be ignited by static electricity. Forms explosive mixtures with oxidizing substances. Corrosive to steel, in particular in the presence of moisture. The provisions of this Code should not apply to sulphur when it is formed to a specific shape (such as prills, granules, pellets, pastilles or flakes). | 1350   |
| –      | T3                                 | TP33          | F-A, S-J               | Category E                | SGG15<br>SG17        | Grey powder. Forms explosive mixtures with oxidizing substances.   | 1352   |

Part 3 – Dangerous Goods List, special provisions and exceptions

Chapter 3.2 – Dangerous Goods List

| UN No. | Proper shipping name (PSN)  | Class or division | Subsidiary hazard(s) | Packing group  | Special provisions | Limited and excepted quantity provisions |                     | Packing      |              | IBC           |               |
|--------|---|-------------------|----------------------|----------------|--------------------|--|---------------------|--------------|--------------|---------------|---------------|
|        |   |                   |                      |                |                    | Limited quantities                       | Excepted quantities | Instructions | Provisions   | Instructions  | Provisions    |
| (1)    | (2)<br>3.1.2  | (3)<br>2.0        | (4)<br>2.0           | (5)<br>2.0.1.3 | (6)<br>3.3         | (7a)<br>3.4                              | (7b)<br>3.5         | (8)<br>4.1.4 | (9)<br>4.1.4 | (10)<br>4.1.4 | (11)<br>4.1.4 |
| 1353   | FIBRES or FABRICS IMPREGNATED WITH WEAKLY NITRATED NITROCELLULOSE, N.O.S.   | 4.1               | –                    | III            | –                  | 5 kg                                     | E1                  | P410         | –            | IBC08         | B3            |
| 1354   | TRINITROBENZENE, WETTED with not less than 30% water, by mass   | 4.1               | –                    | I              | 28                 | 0  | E0                  | P406         | PP31         | –             | –             |
| 1355   | TRINITROBENZOIC ACID, WETTED with not less than 30% water, by mass  | 4.1               | –                    | I              | 28                 | 0  | E0                  | P406         | PP31         | –             | –             |
| 1356   | TRINITROTOLUENE (TNT), WETTED with not less than 30% water, by mass   | 4.1               | –                    | I              | 28                 | 0  | E0                  | P406         | PP31         | –             | –             |
| 1357   | UREA NITRATE, WETTED with not less than 20% water, by mass  | 4.1               | –                    | I              | 28<br>227          | 0  | E0                  | P406         | PP31         | –             | –             |
| 1358   | ZIRCONIUM POWDER, WETTED with not less than 25% water (a visible excess of water must be present)<br>(a) mechanically produced, particle size less than 53 microns;<br>(b) chemically produced, particle size less than 840 microns | 4.1               | –                    | II             | 916                | 1 kg                                     | E2                  | P410         | PP31<br>PP40 | IBC06         | B21           |
| 1360   | CALCIUM PHOSPHIDE   | 4.3               | 6.1                  | I              | –                  | 0  | E0                  | P403         | PP31         | –             | –             |
| △ 1361 | CARBON, animal or vegetable origin  | 4.2               | –                    | II             | 978                | 0  | E0                  | P002         | –            | IBC06         | –             |
| △ 1361 | CARBON, animal or vegetable origin  | 4.2               | –                    | III            | 978                | 0  | E0                  | P002<br>LP02 | –            | IBC08         | B3            |
| △ 1362 | CARBON, ACTIVATED   | 4.2               | –                    | III            | 979                | 0  | E1                  | P002         | PP11<br>PP31 | IBC08         | B3            |
| 1363   | COPRA   | 4.2               | –                    | III            | 29<br>926<br>973   | 0  | E0                  | P003<br>LP02 | PP20         | IBC08         | B3<br>B6      |
| 1364   | COTTON WASTE, OILY  | 4.2               | –                    | III            | 29<br>973          | 0  | E0                  | P003<br>LP02 | PP19         | IBC08         | B3<br>B6      |

| UN No. | Portable tanks and bulk containers |               | EmS                    | Stowage and handling            | Segregation                   | Properties and observations  | UN No. |
|--------|------------------------------------|---------------|------------------------|---------------------------------|-------------------------------|--|--------|
|        | Tank instructions                  | Provisions    |                        |                                 |                               |  |        |
| (12)   | (13)<br>4.2.5<br>4.3               | (14)<br>4.2.5 | (15)<br>5.4.3.4<br>7.8 | (16a)<br>7.1<br>7.3–7.7         | (16b)<br>7.2–7.7              | (17)   | (18)   |
| –      | –                                  | –             | F-A, S-I               | Category D                      | –                             | Toe board used in the manufacture of boots and shoes. When involved in a fire, evolves toxic fumes; in closed compartments, these fumes may form an explosive mixture with air.  | 1353   |
| –      | –                                  | –             | F-B, S-J               | Category E                      | SG7<br>SG30                   | Desensitized explosive. Substance in pure form consists of yellow crystals. When involved in a fire, evolves toxic fumes; in closed compartments these fumes may form an explosive mixture with air. Explosive and sensitive to friction in the dry state. May form extremely sensitive compounds with heavy metals or their salts. Harmful if swallowed or by skin contact.                   | 1354   |
| –      | –                                  | –             | F-B, S-J               | Category E                      | SG7<br>SG30                   | Desensitized explosive. Substance in pure form consists of yellow crystals. Soluble in water. When involved in a fire, evolves toxic fumes; in closed compartments these fumes may form an explosive mixture with air. Explosive and sensitive to friction in the dry state. Harmful if swallowed or by skin contact. May form extremely sensitive compounds with heavy metals or their salts. | 1355   |
| –      | –                                  | –             | F-B, S-J               | Category E                      | SG7<br>SG30                   | Desensitized explosive. Substance in pure form consists of yellow crystals. When involved in a fire, evolves toxic fumes; in closed compartments these fumes may form an explosive mixture with air. Explosive and sensitive to friction in the dry state. May form extremely sensitive compounds with heavy metals or their salts. Harmful if swallowed or by skin contact.                   | 1356   |
| –      | –                                  | –             | F-B, S-J               | Category E                      | SG7<br>SG30                   | Desensitized explosive. Substance in pure form consists of white crystals. Soluble in water. When involved in a fire, evolves toxic fumes; in closed compartments these fumes may form an explosive mixture with air. Explosive and sensitive to friction in the dry state. May form extremely sensitive compounds with heavy metals or their salts.   | 1357   |
| –      | T3                                 | TP33          | F-G, S-J               | Category E<br>H1                | SGG15<br>SG17<br>SG25<br>SG26 | Grey powder. Insoluble in water. Liable to spontaneous combustion when dry. Forms explosive mixtures with oxidizing substances.  | 1358   |
| –      | –                                  | –             | F-G, S-N               | Category E<br>SW2<br>SW5<br>H1  | SG26<br>SG35                  | Red to brown crystals. Reacts with acids or decomposes slowly in contact with water or damp air, evolving phosphine, a spontaneously flammable and highly toxic gas. Reacts violently with oxidizing substances. Toxic if swallowed, by skin contact or by inhalation.   | 1360   |
| –      | T3                                 | TP33          | F-A, S-J               | Category A<br>SW1<br>SW27<br>H2 | –                             | Black material originating from organic sources. Particularly includes carbon blacks of animal or vegetable origin, other non-activated carbon materials and charcoal produced from materials such as bone, bamboo, coconut shell, jute and wood. Liable to heat slowly and ignite spontaneously in air.   | 1361 △ |
| –      | T1                                 | TP33          | F-A, S-J               | Category A<br>SW1<br>SW27<br>H2 | –                             | See entry above.   | 1361 △ |
| –      | T1                                 | TP33          | F-A, S-J               | Category A<br>SW1<br>SW27<br>H2 | –                             | Activated porous black carbon materials not including charcoal (see UN 1361). May be in the form of powder, granules, pellets, fibres or felts. If chemically activated, may self-heat, and may ignite spontaneously in air.   | 1362 △ |
| –      | BK2                                | –             | F-A, S-J               | Category A<br>SW1<br>SW9<br>H1  | –                             | Dried kernels of coconuts, with a penetrating rancid odour which may taint other cargoes.  | 1363   |
| –      | –                                  | –             | F-A, S-J               | Category A                      | SG41                          | Fibres of vegetable origin.  | 1364   |

Part 3 – Dangerous Goods List, special provisions and exceptions

Chapter 3.2 – Dangerous Goods List

| UN No. | Proper shipping name (PSN)  | Class or division | Subsidiary hazard(s) | Packing group  | Special provisions      | Limited and excepted quantity provisions |                     | Packing      |                      | IBC           |               |
|--------|---|-------------------|----------------------|----------------|-------------------------|--|---------------------|--------------|----------------------|---------------|---------------|
|        |   |                   |                      |                |                         | Limited quantities                       | Excepted quantities | Instructions | Provisions           | Instructions  | Provisions    |
| (1)    | (2)<br>3.1.2  | (3)<br>2.0        | (4)<br>2.0           | (5)<br>2.0.1.3 | (6)<br>3.3              | (7a)<br>3.4                              | (7b)<br>3.5         | (8)<br>4.1.4 | (9)<br>4.1.4         | (10)<br>4.1.4 | (11)<br>4.1.4 |
| 1365   | COTTON, WET   | 4.2               | –                    | III            | 29<br>973               | 0  | E0                  | P003         | PP19                 | IBC08         | B3<br>B6      |
| 1369   | p-NITROSODIMETHYLANILINE  | 4.2               | –                    | II             | 927                     | 0  | E2                  | P410         | –                    | IBC06         | B21           |
| 1372   | FIBRES, ANIMAL or FIBRES, VEGETABLE burnt, wet or damp  | 4.2               | –                    | III            | 123                     | 0  | E1                  | P410         | –                    | –             | –             |
| 1373   | FIBRES or FABRICS, ANIMAL or VEGETABLE or SYNTHETIC, N.O.S. with oil  | 4.2               | –                    | III            | –                       | 0  | E0                  | P410         | PP31                 | IBC08         | B3            |
| 1374   | FISH MEAL, UNSTABILIZED or FISH SCRAP, UNSTABILIZED<br>High hazard.<br>Unrestricted moisture content.<br>Unrestricted fat content in excess of 12%, by mass;<br>unrestricted fat content in excess of 15%, by mass, in the case of anti-oxidant treated fish meal or fish scrap | 4.2               | –                    | II             | 300<br>928              | 0  | E2                  | P410         | PP31<br>PP40         | IBC08         | B4<br>B21     |
| 1374   | FISH MEAL, UNSTABILIZED or FISH SCRAP, UNSTABILIZED<br>Not anti-oxidant treated.<br>Moisture content: more than 5% but not more than 12%, by mass.<br>Fat content: not more than 12%, by mass   | 4.2               | –                    | III            | 29<br>300<br>907<br>928 | 0  | E1                  | P410         | PP31                 | IBC08         | B3<br>B21     |
| 1376   | IRON OXIDE, SPENT or IRON SPONGE, SPENT obtained from coal gas purification   | 4.2               | –                    | III            | 223                     | 0  | E0                  | P002<br>LP02 | PP100<br>L3          | IBC08         | B4            |
| 1378   | METAL CATALYST, WETTED with a visible excess of liquid  | 4.2               | –                    | II             | 274                     | 0  | E0                  | P410         | PP31<br>PP39<br>PP40 | IBC01         | –             |
| 1379   | PAPER, UNSATURATED OIL TREATED, incompletely dried (including carbon paper)   | 4.2               | –                    | III            | –                       | 0  | E0                  | P410         | PP31                 | IBC08         | B3            |
| 1380   | PENTABORANE   | 4.2               | 6.1                  | I              | –                       | 0  | E0                  | P601         | –                    | –             | –             |
| 1381   | PHOSPHORUS, WHITE or YELLOW, DRY or UNDER WATER or IN SOLUTION  | 4.2               | 6.1<br>P             | I              | –                       | 0  | E0                  | P405         | PP31                 | –             | –             |
| 1382   | POTASSIUM SULPHIDE, ANHYDROUS or POTASSIUM SULPHIDE with less than 30% water of crystallization   | 4.2               | –                    | II             | –                       | 0  | E2                  | P410         | PP31<br>PP40         | IBC06         | B21           |
| 1383   | PYROPHORIC METAL, N.O.S. or PYROPHORIC ALLOY, N.O.S.  | 4.2               | –                    | I              | 274                     | 0  | E0                  | P404         | PP31                 | –             | –             |
| 1384   | SODIUM DITHIONITE (SODIUM HYDROSULPHITE)  | 4.2               | –                    | II             | –                       | 0  | E2                  | P410         | PP31                 | IBC06         | B21           |
| 1385   | SODIUM SULPHIDE, ANHYDROUS or SODIUM SULPHIDE with less than 30% water of crystallization   | 4.2               | –                    | II             | –                       | 0  | E2                  | P410         | PP31                 | IBC06         | B21           |

| UN No. | Portable tanks and bulk containers |               | EmS                    | Stowage and handling      | Segregation      | Properties and observations   | UN No. |
|--------|------------------------------------|---------------|------------------------|---------------------------|------------------|---|--------|
|        | Tank instructions                  | Provisions    |                        |                           |                  |   |        |
| (12)   | (13)<br>4.2.5<br>4.3               | (14)<br>4.2.5 | (15)<br>5.4.3.4<br>7.8 | (16a)<br>7.1<br>7.3–7.7   | (16b)<br>7.2–7.7 | (17)  | (18)   |
| –      | –                                  | –             | F-A, S-J               | Category A                | –                | Readily combustible, liable to ignite spontaneously according to moisture content.  | 1365   |
| –      | T3                                 | TP33          | F-A, S-J               | Category D                | SG29             | Dark green, crystalline solid, insoluble in water. Ignites spontaneously in air when dry. Harmful if swallowed.   | 1369   |
| –      | –                                  | –             | F-A, S-J               | Category A                | –                | Liable to ignite spontaneously according to moisture content.   | 1372   |
| –      | T1                                 | TP33          | F-A, S-J               | Category A                | –                | Liable to ignite spontaneously according to the oil content.  | 1373   |
| –      | T3                                 | TP33          | F-A, S-J               | Category B<br>SW1<br>SW24 | SG65             | Brown to greenish-brown product derived from oily fish. Strong odour which may affect other cargo. Liable to heat and ignite spontaneously.   | 1374   |
| –      | T1                                 | TP33          | F-A, S-J               | Category A<br>SW1<br>SW24 | –                | See entry above.  | 1374   |
| –      | T1<br>BK2                          | TP33          | F-G, S-P               | Category E<br>H1          | SG26             | Obtained from coal gas purification. Strong odour which may taint other cargo. Liable to heat and ignite spontaneously. May evolve hydrogen sulphide, sulphur dioxide and hydrogen cyanide, which are toxic gases. This substance should have been cooled and weathered for not less than eight weeks before shipment, unless packed in a metal drum. | 1376   |
| –      | T3                                 | TP33          | F-H, S-M               | Category C                | –                | Liable to ignite spontaneously if dry.  | 1378   |
| –      | –                                  | –             | F-A, S-J               | Category A                | –                | Liable to ignite spontaneously. The provisions of this Code should not apply to manufactured articles properly aged.  | 1379   |
| –      | –                                  | –             | F-G, S-L               | Category D<br>H1          | SG26             | Colourless liquid. Boiling point range: 48°C to 63°C. Ignites spontaneously in air. Decomposes in contact with water, evolving hydrogen, a flammable gas. Toxic if swallowed, by skin contact or by inhalation.   | 1380   |
| –      | T9                                 | TP3<br>TP31   | F-A, S-J               | Category E                | –                | Ignites spontaneously in air. Melting point: 44°C. Toxic if swallowed, by skin contact or by inhalation. Receptacles are usually filled with substance in the liquid state which subsequently solidifies. A sufficient ullage should be allowed.  | 1381   |
| –      | T3                                 | TP33          | F-A, S-J               | Category A                | SGG18<br>SG35    | Black solid, absorbs moisture to become crystalline. Liable to ignite spontaneously in air and to evolve sulphur dioxide, an irritating gas. Reacts violently with acids.   | 1382   |
| –      | T21                                | TP7<br>TP33   | F-G, S-M               | Category D<br>H1          | SGG15<br>SG26    | Liable to ignite spontaneously in air. If shaken, may produce sparks. In contact with water, evolves hydrogen, a flammable gas.   | 1383   |
| –      | T3                                 | TP33          | F-A, S-J               | Category E<br>H1          | –                | White or grey crystalline powder. Liable to heat and ignite spontaneously in air and to evolve sulphur dioxide, an irritating gas.  | 1384   |
| –      | T3                                 | TP33          | F-A, S-J               | Category A                | SGG18<br>SG35    | Black solid, absorbs moisture to become crystalline. Liable to ignite spontaneously. In contact with acids, evolves hydrogen sulphide, a toxic and flammable gas. Reacts violently with acids.  | 1385   |



Part 3 – Dangerous Goods List, special provisions and exceptions

Chapter 3.2 – Dangerous Goods List

| UN No. | Proper shipping name (PSN)  | Class or division | Subsidiary hazard(s) | Packing group  | Special provisions | Limited and excepted quantity provisions |                     | Packing      |              | IBC           |               |
|--------|---|-------------------|----------------------|----------------|--------------------|--|---------------------|--------------|--------------|---------------|---------------|
|        |   |                   |                      |                |                    | Limited quantities                       | Excepted quantities | Instructions | Provisions   | Instructions  | Provisions    |
| (1)    | (2)<br>3.1.2  | (3)<br>2.0        | (4)<br>2.0           | (5)<br>2.0.1.3 | (6)<br>3.3         | (7a)<br>3.4                              | (7b)<br>3.5         | (8)<br>4.1.4 | (9)<br>4.1.4 | (10)<br>4.1.4 | (11)<br>4.1.4 |
| 1386   | SEED CAKE, containing vegetable oil<br>(a) mechanically expelled seeds, containing more than 10% oil or more than 20% oil and moisture combined   | 4.2               | –                    | III            | 29<br>929<br>973   | 0  | E0                  | P003<br>LP02 | PP20         | IBC08         | B3<br>B6      |
| 1386   | SEED CAKE, containing vegetable oil<br>(b) solvent extractions and expelled seeds, containing not more than 10% of oil and when the amount of moisture is higher than 10%, not more than 20% of oil and moisture combined | 4.2               | –                    | III            | 29<br>929<br>973   | 0  | E0                  | P003<br>LP02 | PP20         | IBC08         | B3<br>B6      |
| 1387   | WOOL WASTE, WET   | 4.2               | –                    | III            | 123                | 0  | E1                  | P410         | –            | –             | –             |
| 1389   | ALKALI METAL AMALGAM, LIQUID  | 4.3               | –                    | I              | 182                | 0  | E0                  | P402         | PP31         | –             | –             |
| 1390   | ALKALI METAL AMIDES   | 4.3               | –                    | II             | 182                | 500 g                                    | E2                  | P410         | PP31<br>PP40 | IBC07         | B4<br>B21     |
| △ 1391 | ALKALI METAL DISPERSION or ALKALINE EARTH METAL DISPERSION  | 4.3               | –                    | I              | 182<br>183         | 0  | E0                  | P402         | PP31         | –             | –             |
| 1392   | ALKALINE EARTH METAL AMALGAM, LIQUID  | 4.3               | –                    | I              | 183                | 0  | E0                  | P402         | PP31         | –             | –             |
| 1393   | ALKALINE EARTH METAL ALLOY, N.O.S.  | 4.3               | –                    | II             | 183                | 500 g                                    | E2                  | P410         | PP31<br>PP40 | IBC07         | B4<br>B21     |
| 1394   | ALUMINIUM CARBIDE   | 4.3               | –                    | II             | –                  | 500 g                                    | E2                  | P410         | PP31<br>PP40 | IBC07         | B4<br>B21     |
| 1395   | ALUMINIUM FERROSILICON POWDER   | 4.3               | 6.1                  | II             | 932                | 500 g                                    | E2                  | P410         | PP31<br>PP40 | IBC05         | B21           |
| 1396   | ALUMINIUM POWDER, UNCOATED  | 4.3               | –                    | II             | –                  | 500 g                                    | E2                  | P410         | PP31<br>PP40 | IBC07         | B4<br>B21     |
| 1396   | ALUMINIUM POWDER, UNCOATED  | 4.3               | –                    | III            | 223                | 1 kg                                     | E1                  | P410         | PP31         | IBC08         | B4            |

| UN No. | Portable tanks and bulk containers |                    | EmS                    | Stowage and handling            | Segregation                           | Properties and observations  | UN No. |
|--------|------------------------------------|--------------------|------------------------|---------------------------------|---------------------------------------|--|--------|
|        | Tank instructions                  | Provisions         |                        |                                 |                                       |  |        |
| (12)   | (13)<br>4.2.5<br>4.3               | (14)<br>4.2.5      | (15)<br>5.4.3.4<br>7.8 | (16a)<br>7.1<br>7.3–7.7         | (16b)<br>7.2–7.7                      | (17)   | (18)   |
| –      | BK2                                | –                  | F-A, S-J               | Category E<br>SW1<br>SW25<br>H1 | –                                     | Residue remaining after oil has been expelled mechanically from oil-bearing seeds. Used mainly as animal feed or fertilizer. The most common seed cakes include those derived from coconut (copra), cottonseed, groundnut (peanut), linseed, maize (hominy chop), niger seed, palm kernel, rape seed, rice bran, soya bean and sunflower seed and they may be shipped in the form of cake, flakes, pellets, meal, etc. May self-heat slowly and, if wet or containing an excessive proportion of unoxidized oil, ignite spontaneously. Before shipment, this cargo should be properly aged. The duration of ageing varies with the oil content. Smoking and the use of naked lights should be prohibited during loading and unloading and on entry to the cargo space(s) at any time.  | 1386   |
| –      | BK2                                | –                  | F-A, S-J               | Category A<br>SW1<br>SW25<br>H1 | –                                     | Residue remaining after oil has been extracted by a solvent process or expelled mechanically from oil-bearing seeds. Used mainly as animal feed or fertilizer. The most common seed cakes include those derived from coconut (copra), cottonseed, groundnut (peanut), linseed, maize (hominy chop), niger seed, palm kernel, rape seed, rice bran, soya bean and sunflower seed and they may be shipped in the form of cake, flakes, pellets, meal, etc. May self-heat slowly and, if wet or containing an excessive proportion of unoxidized oil, ignite spontaneously. The seed cake should be substantially free from flammable solvent. Before shipment, this cargo should be properly aged. The duration of ageing varies with the oil content. Smoking and the use of naked lights should be prohibited during loading and unloading and on entry to the cargo space(s) at any other time. | 1386   |
| –      | –                                  | –                  | F-A, S-J               | Category A                      | –                                     | Liable to ignite spontaneously in air according to moisture content.   | 1387   |
| –      | –                                  | –                  | F-G, S-N               | Category D<br>H1                | SGG7<br>SGG11<br>SG26<br>SG35         | Silvery liquid, consisting of metal alloyed with mercury. Reacts with moisture, water or acids, evolving hydrogen, a flammable gas. When heated, evolves toxic vapours.  | 1389   |
| –      | T3                                 | TP33               | F-G, S-O               | Category E<br>SW2<br>H1         | SG26<br>SG35                          | Small crystals. Decomposes in contact with water or acids, evolving ammonia vapour and producing highly caustic alkaline solutions.  | 1390   |
| –      | T13                                | TP2<br>TP7<br>TP42 | F-G, S-N               | Category D<br>H1                | SG26<br>SG35                          | Finely divided alkali metal or alkaline earth metal, suspended in a liquid. Reacts violently with moisture, water or acids, evolving hydrogen, which may be ignited by the heat of the reaction.   | △ 1391 |
| –      | –                                  | –                  | F-G, S-N               | Category D<br>H1                | SGG7<br>SGG11<br>SG26<br>SG35         | Consists of metal alloyed with mercury. Contains 2% to 10% alkaline earth metals and may contain up to 98% mercury. Reacts with moisture, water or acids, evolving hydrogen, a flammable gas. When heated, evolves toxic vapours.  | 1392   |
| –      | T3                                 | TP33               | F-G, S-N               | Category E<br>H1                | SG26<br>SG35                          | When containing a substantial proportion of alkaline earth metals, readily decomposed by water and reacts violently with acids, evolving hydrogen, which may be ignited by the heat of the reaction.   | 1393   |
| –      | T3                                 | TP33               | F-G, S-N               | Category A<br>H1                | SG26<br>SG35                          | Yellow crystals or powder. In contact with water, rapidly evolves methane, a flammable gas. Reacts violently with acids.   | 1394   |
| –      | T3<br>BK2                          | TP33               | F-G, S-N               | Category A<br>SW2<br>SW5<br>H1  | SG26<br>SG32<br>SG35<br>SG36          | In contact with water, caustic alkalis or acids, evolves hydrogen, a flammable gas. Impurities may, under similar circumstances, produce phosphine and arsine, which are highly toxic gases.   | 1395   |
| –      | T3                                 | TP33               | F-G, S-O               | Category A<br>H1                | SGG15<br>SG26<br>SG32<br>SG35<br>SG36 | In contact with water, caustic alkalis or acids, evolves hydrogen, a flammable gas. When finely divided aluminium dust is scattered, it is easily ignited by naked lights, causing explosion. May explode when in contact with oxidizing substances. Reacts with liquid halogenated hydrocarbons.  | 1396   |
| –      | T1                                 | TP33               | F-G, S-O               | Category A<br>H1                | SGG15<br>SG26<br>SG32<br>SG35<br>SG36 | See entry above.   | 1396   |

Part 3 – Dangerous Goods List, special provisions and exceptions

Chapter 3.2 – Dangerous Goods List

| UN No. | Proper shipping name (PSN)                              | Class or division | Subsidiary hazard(s) | Packing group  | Special provisions | Limited and excepted quantity provisions |                     | Packing      |               | IBC           |               |
|--------|---|-------------------|----------------------|----------------|--------------------|--|---------------------|--------------|---------------|---------------|---------------|
|        |   |                   |                      |                |                    | Limited quantities                       | Excepted quantities | Instructions | Provisions    | Instructions  | Provisions    |
| (1)    | (2)<br>3.1.2  | (3)<br>2.0        | (4)<br>2.0           | (5)<br>2.0.1.3 | (6)<br>3.3         | (7a)<br>3.4                              | (7b)<br>3.5         | (8)<br>4.1.4 | (9)<br>4.1.4  | (10)<br>4.1.4 | (11)<br>4.1.4 |
| 1397   | ALUMINIUM PHOSPHIDE                                     | 4.3               | 6.1                  | I              | –                  | 0  | E0                  | P403         | PP31          | –             | –             |
| 1398   | ALUMINIUM SILICON POWDER, UNCOATED                      | 4.3               | –                    | III            | 37<br>223<br>932   | 1 kg                                     | E1                  | P410         | PP31          | IBC08         | B4            |
| 1400   | BARIUM  | 4.3               | –                    | II             | –                  | 500 g                                    | E2                  | P410         | PP31<br>PP40  | IBC07         | B4<br>B21     |
| 1401   | CALCIUM   | 4.3               | –                    | II             | –                  | 500 g                                    | E2                  | P410         | PP31<br>PP40  | IBC07         | B4<br>B21     |
| 1402   | CALCIUM CARBIDE   | 4.3               | –                    | I              | –                  | 0  | E0                  | P403         | PP31          | IBC04         | B1            |
| 1402   | CALCIUM CARBIDE   | 4.3               | –                    | II             | –                  | 500 g                                    | E2                  | P410         | PP31<br>PP40  | IBC07         | B4<br>B21     |
| 1403   | CALCIUM CYANAMIDE with more than 0.1% calcium carbide   | 4.3               | –                    | III            | 38<br>934          | 1 kg                                     | E1                  | P410         | PP31          | IBC08         | B4            |
| 1404   | CALCIUM HYDRIDE   | 4.3               | –                    | I              | –                  | 0  | E0                  | P403         | PP31          | –             | –             |
| 1405   | CALCIUM SILICIDE  | 4.3               | –                    | II             | 932                | 500 g                                    | E2                  | P410         | PP31<br>PP40  | IBC07         | B4<br>B21     |
| 1405   | CALCIUM SILICIDE  | 4.3               | –                    | III            | 223<br>932         | 1 kg                                     | E1                  | P410         | PP31          | IBC08         | B4            |
| 1407   | CAESIUM   | 4.3               | –                    | I              | –                  | 0  | E0                  | P403         | PP31          | IBC04         | B1            |
| 1408   | FERROSILICON with 30% or more but less than 90% silicon | 4.3               | 6.1                  | III            | 39<br>223<br>932   | 1 kg                                     | E1                  | P003         | PP20<br>PP100 | IBC08         | B4<br>B6      |
| 1409   | METAL HYDRIDES, WATER-REACTIVE, N.O.S.                  | 4.3               | –                    | I              | 274                | 0  | E0                  | P403         | PP31          | –             | –             |
| 1409   | METAL HYDRIDES, WATER-REACTIVE, N.O.S.                  | 4.3               | –                    | II             | 274                | 500 g                                    | E2                  | P410         | PP31<br>PP40  | IBC04         | –             |
| 1410   | LITHIUM ALUMINIUM HYDRIDE                               | 4.3               | –                    | I              | –                  | 0  | E0                  | P403         | PP31          | –             | –             |
| 1411   | LITHIUM ALUMINIUM HYDRIDE, ETHEREAL                     | 4.3               | 3                    | I              | –                  | 0  | E0                  | P402         | –             | –             | –             |
| 1413   | LITHIUM BOROXYDRIDE                                     | 4.3               | –                    | I              | –                  | 0  | E0                  | P403         | PP31          | –             | –             |

| UN No. | Portable tanks and bulk containers |               | EmS                    | Stowage and handling           | Segregation                           | Properties and observations   | UN No. |
|--------|------------------------------------|---------------|------------------------|--------------------------------|---------------------------------------|---|--------|
|        | Tank instructions                  | Provisions    |                        |                                |                                       |   |        |
| (12)   | (13)<br>4.2.5<br>4.3               | (14)<br>4.2.5 | (15)<br>5.4.3.4<br>7.8 | (16a)<br>7.1<br>7.3–7.7        | (16b)<br>7.2–7.7                      | (17)  | (18)   |
| –      | –                                  | –             | F-G, S-N               | Category E<br>SW2<br>SW5<br>H1 | SG26<br>SG35                          | Crystals or powder. Reacts with acids or decomposes slowly in contact with water or damp air, evolving phosphine, a spontaneously flammable and highly toxic gas. Reacts violently with oxidizing substances. Toxic if swallowed, by skin contact or by inhalation.   | 1397   |
| –      | T1<br>BK2                          | TP33          | F-G, S-N               | Category A<br>SW2<br>SW5<br>H1 | SGG15<br>SG26<br>SG32<br>SG35<br>SG36 | In contact with water, caustic alkalis or acids, generates heat and evolves hydrogen, a flammable gas. May also evolve silanes, which are toxic and may ignite spontaneously.   | 1398   |
| –      | T3                                 | TP33          | F-G, S-O               | Category E<br>H1               | SG26<br>SG35                          | Readily decomposes in water and reacts violently with acids, evolving hydrogen, which may be ignited by the heat of the reaction. Harmful if swallowed or by dust inhalation.   | 1400   |
| –      | T3                                 | TP33          | F-G, S-O               | Category E<br>H1               | SG26<br>SG35                          | Readily decomposes in water and reacts violently with acids, evolving hydrogen, which may be ignited by the heat of the reaction.   | 1401   |
| –      | –                                  | –             | F-G, S-N               | Category B<br>H1               | SG26<br>SG35                          | Solid. In contact with water, rapidly evolves acetylene, a highly flammable gas, which may be ignited by the heat of the reaction. Acetylene forms highly explosive compounds with salts of some heavy metals. Reacts violently with acids.   | 1402   |
| –      | T3                                 | TP33          | F-G, S-N               | Category B<br>H1               | SG26<br>SG35                          | See entry above.  | 1402   |
| –      | T1                                 | TP33          | F-G, S-N               | Category A<br>H1               | SG26<br>SG35                          | Powder or granules. Contains calcium carbide as an impurity. In contact with water, evolves ammonia and acetylene, which is a highly flammable gas. Reacts vigorously with acids.   | 1403   |
| –      | –                                  | –             | F-G, S-O               | Category E<br>H1               | SG26<br>SG35                          | Solid. In contact with water, acids or moisture, evolves hydrogen, which may be ignited by the heat of the reaction.  | 1404   |
| –      | T3                                 | TP33          | F-G, S-N               | Category B<br>SW5<br>H1        | SG26<br>SG35                          | In contact with water, evolves hydrogen, a flammable gas. If calcium carbide is present as an impurity, acetylene will also be evolved. In contact with acids, evolves silane, a spontaneously flammable gas.   | 1405   |
| –      | T1                                 | TP33          | F-G, S-N               | Category B<br>SW5<br>H1        | SG26<br>SG35                          | See entry above.  | 1405   |
| –      | –                                  | –             | F-G, S-N               | Category D<br>H1               | SG26<br>SG35                          | White, ductile, soft metal. Reacts violently with moisture, water or acids, evolving hydrogen, which may be ignited by the heat of the reaction. Highly reactive, sometimes with explosive effect.  | 1407   |
| –      | T1<br>BK2                          | TP33          | F-G, S-N               | Category A<br>SW2<br>SW5<br>H1 | SG26<br>SG35<br>SG36                  | In contact with moisture, water, alkalis or acids, may evolve hydrogen, a flammable gas, which may form explosive mixtures with air, and also arsine and phosphine, which are highly toxic gases. These gases are evolved in proportions which, under mechanically ventilated conditions, make the poison hazard by far predominant over the explosion hazard. The rate of gas evolution is greatest from freshly broken surfaces, so is liable to increase whenever the cargo is disturbed, such as during loading. Toxic if swallowed, by skin contact or by vapour inhalation. | 1408   |
| –      | –                                  | –             | F-G, S-L               | Category D<br>H1               | SG26<br>SG35                          | Solids. React with water, moisture or acids, evolving hydrogen, which may be ignited by the heat of the reaction.   | 1409   |
| –      | T3                                 | TP33          | F-G, S-L               | Category D<br>H1               | SG26<br>SG35                          | See entry above.  | 1409   |
| –      | –                                  | –             | F-G, S-M               | Category E<br>H1               | SG26<br>SG35                          | White powder. In contact with water, acids or moisture, evolves hydrogen, which may be ignited by the heat of the reaction.   | 1410   |
| –      | –                                  | –             | F-G, S-M               | Category D<br>SW2<br>H1        | SG26                                  | Clear, colourless solution of lithium aluminium hydride in ether. Reacts readily with water, evolving hydrogen, a flammable gas. Evaporates readily to leave a residue which is easily ignited by a spark or friction.  | 1411   |
| –      | –                                  | –             | F-G, S-O               | Category E<br>H1               | SG26<br>SG35                          | Crystalline, hygroscopic solid. In contact with water, acids or moisture, evolves hydrogen, which may be ignited by the heat of the reaction.   | 1413   |

Part 3 – Dangerous Goods List, special provisions and exceptions

Chapter 3.2 – Dangerous Goods List

| UN No. | Proper shipping name (PSN)                  | Class or division | Subsidiary hazard(s) | Packing group  | Special provisions | Limited and excepted quantity provisions |                          | Packing          |                | IBC               |                 |
|--------|---|-------------------|----------------------|----------------|--------------------|--|--------------------------|------------------|----------------|-------------------|-----------------|
|        |   |                   |                      |                |                    | Limited quantities (7a)                  | Excepted quantities (7b) | Instructions (8) | Provisions (9) | Instructions (10) | Provisions (11) |
| (1)    | (2)<br>3.1.2                                | (3)<br>2.0        | (4)<br>2.0           | (5)<br>2.0.1.3 | (6)<br>3.3         | (7a)<br>3.4                              | (7b)<br>3.5              | (8)<br>4.1.4     | (9)<br>4.1.4   | (10)<br>4.1.4     | (11)<br>4.1.4   |
| 1414   | LITHIUM HYDRIDE                             | 4.3               | –                    | I              | –                  | 0  | E0                       | P403             | PP31           | –                 | –               |
| 1415   | LITHIUM                                     | 4.3               | –                    | I              | –                  | 0  | E0                       | P403             | PP31           | IBC04             | B1              |
| 1417   | LITHIUM SILICON                             | 4.3               | –                    | II             | –                  | 500 g                                    | E2                       | P410             | PP31<br>PP40   | IBC07             | B4<br>B21       |
| 1418   | MAGNESIUM POWDER or MAGNESIUM ALLOYS POWDER | 4.3               | 4.2                  | I              | –                  | 0  | E0                       | P403             | PP31           | –                 | –               |
| 1418   | MAGNESIUM POWDER or MAGNESIUM ALLOYS POWDER | 4.3               | 4.2                  | II             | –                  | 0  | E2                       | P410             | PP31<br>PP40   | IBC05             | B21             |
| 1418   | MAGNESIUM POWDER or MAGNESIUM ALLOYS POWDER | 4.3               | 4.2                  | III            | 223                | 0  | E1                       | P410             | PP31           | IBC08             | B4              |
| 1419   | MAGNESIUM ALUMINIUM PHOSPHIDE               | 4.3               | 6.1                  | I              | –                  | 0  | E0                       | P403             | PP31           | –                 | –               |
| 1420   | POTASSIUM METAL ALLOYS, LIQUID              | 4.3               | –                    | I              | –                  | 0  | E0                       | P402             | PP31           | –                 | –               |
| 1421   | ALKALI METAL ALLOY, LIQUID, N.O.S.          | 4.3               | –                    | I              | 182                | 0  | E0                       | P402             | PP31           | –                 | –               |
| 1422   | POTASSIUM SODIUM ALLOYS, LIQUID             | 4.3               | –                    | I              | –                  | 0  | E0                       | P402             | PP31           | –                 | –               |
| 1423   | RUBIDIUM                                    | 4.3               | –                    | I              | –                  | 0  | E0                       | P403             | PP31           | IBC04             | B1              |
| 1426   | SODIUM BOROHYDRIDE                          | 4.3               | –                    | I              | –                  | 0  | E0                       | P403             | PP31           | –                 | –               |
| 1427   | SODIUM HYDRIDE                              | 4.3               | –                    | I              | –                  | 0  | E0                       | P403             | PP31           | –                 | –               |
| 1428   | SODIUM                                      | 4.3               | –                    | I              | –                  | 0  | E0                       | P403             | PP31           | IBC04             | B1              |
| 1431   | SODIUM METHYLATE                            | 4.2               | 8                    | II             | –                  | 0  | E2                       | P410             | PP31           | IBC05             | B21             |

| UN No. | Portable tanks and bulk containers |                    | EmS                    | Stowage and handling    | Segregation                   | Properties and observations  | UN No. |
|--------|------------------------------------|--------------------|------------------------|-------------------------|-------------------------------|--|--------|
|        | Tank instructions (12)             | Provisions (14)    |                        |                         |                               |  |        |
| (12)   | (13)<br>4.2.5<br>4.3               | (14)<br>4.2.5      | (15)<br>5.4.3.4<br>7.8 | (16a)<br>7.1<br>7.3–7.7 | (16b)<br>7.2–7.7              | (17)   | (18)   |
| –      | –                                  | –                  | F-G, S-N               | Category E H1           | SG26<br>SG35                  | Solid. In contact with water, acids or moisture, evolves hydrogen, which may be ignited by the heat of the reaction.   | 1414   |
| –      | T9                                 | TP7<br>TP33        | F-G, S-N               | Category E H1           | SG26<br>SG35                  | White, ductile, soft metal. Floats on water. Readily decomposes in water and reacts violently with acids, evolving hydrogen, which may be ignited by the heat of the reaction. For fire-fighting purposes, dry lithium chloride powder, dry sodium chloride or graphite powder should be carried on board when this substance is transported.  | 1415   |
| –      | T3                                 | TP33               | F-G, S-N               | Category A SW5 H1       | SG26                          | Shiny lumps, crystals or powder, with sharp irritating odour. Reacts readily with water, evolving hydrogen and silane, flammable gases. Enough heat may be generated to ignite the gas mixture in air.   | 1417   |
| –      | –                                  | –                  | F-G, S-O               | Category A H1           | SGG15<br>SG26<br>SG32<br>SG35 | In contact with moisture, water or acids, evolves hydrogen, a flammable gas. Magnesium dust is easily ignited, causing explosion. May explode when in contact with oxidizing substances. For fire-fighting purposes, dry lithium chloride powder, dry sodium chloride or graphite powder should be carried on board when this substance is transported. Reacts with liquid halogenated hydrocarbons. | 1418   |
| –      | T3                                 | TP33               | F-G, S-O               | Category A H1           | SGG15<br>SG26<br>SG32<br>SG35 | See entry above.   | 1418   |
| –      | T1                                 | TP33               | F-G, S-O               | Category A H1           | SGG15<br>SG26<br>SG32<br>SG35 | See entry above.   | 1418   |
| –      | –                                  | –                  | F-G, S-N               | Category E SW2 SW5 H1   | SG26<br>SG35                  | Solid. Reacts with acids or decomposes slowly in contact with water or damp air, evolving phosphine, a spontaneously flammable and highly toxic gas. Reacts violently with oxidizing substances. Toxic if swallowed, by skin contact or by inhalation.   | 1419   |
| –      | –                                  | –                  | F-G, S-L               | Category D H1           | SG26<br>SG35                  | Soft, silvery metal liquid. Floats on water. Reacts violently with moisture, water or acids, evolving hydrogen, which may be ignited by the heat of the reaction. Highly reactive, sometimes with explosive effect.  | 1420   |
| –      | –                                  | –                  | F-G, S-L               | Category D H1           | SG26<br>SG35                  | Flows like mercury at ordinary temperatures. Not volatile. Reacts violently with moisture, water or acids, evolving hydrogen, a flammable gas, and developing considerable heat, which may ignite the gas.   | 1421   |
| –      | T9                                 | TP3<br>TP7<br>TP31 | F-G, S-L               | Category D H1           | SG26<br>SG35                  | Soft, silvery metal liquid. Floats on water. Reacts violently with moisture, water or acids, evolving hydrogen, which may be ignited by the heat of the reaction. Highly reactive, sometimes with explosive effect.  | 1422   |
| –      | –                                  | –                  | F-G, S-N               | Category D H1           | SG26<br>SG35                  | Silvery-white, ductile, soft metal. Melting point: 39°C. Floats on water. Reacts violently with moisture, water or acids, evolving hydrogen, which may be ignited by the heat of the reaction. Highly reactive, sometimes with explosive effect.   | 1423   |
| –      | –                                  | –                  | F-G, S-O               | Category E H1           | SG26<br>SG35                  | Crystalline powder. In contact with water, acids or moisture, evolves hydrogen, which may be ignited by the heat of the reaction.  | 1426   |
| –      | –                                  | –                  | F-G, S-O               | Category E H1           | SG26<br>SG35                  | White powder. In contact with water, acids or moisture, evolves hydrogen, which may be ignited by the heat of the reaction.  | 1427   |
| –      | T9                                 | TP7<br>TP33        | F-G, S-N               | Category D H1           | SG26<br>SG35                  | White, ductile, soft metal. Floats on water. Reacts violently with moisture, water or acids, evolving hydrogen, which may be ignited by the heat of the reaction. Highly reactive, sometimes with explosive effect.  | 1428   |
| –      | T3                                 | TP33               | F-A, S-L               | Category B              | SGG18<br>SG35                 | White, amorphous, free-flowing, hygroscopic powder. Decomposed by water to form methanol, a flammable liquid, which may be ignited by the heat of the reaction. Causes burns to skin, eyes and mucous membranes.   | 1431   |

Part 3 – Dangerous Goods List, special provisions and exceptions

Chapter 3.2 – Dangerous Goods List

| UN No. | Proper shipping name (PSN) | Class or division | Subsidiary hazard(s) | Packing group  | Special provisions | Limited and excepted quantity provisions |                          | Packing          |                | IBC               |                 |
|--------|----------------------------|-------------------|----------------------|----------------|--------------------|--|--------------------------|------------------|----------------|-------------------|-----------------|
|        |                            |                   |                      |                |                    | Limited quantities (7a)                  | Excepted quantities (7b) | Instructions (8) | Provisions (9) | Instructions (10) | Provisions (11) |
| (1)    | (2)<br>3.1.2               | (3)<br>2.0        | (4)<br>2.0           | (5)<br>2.0.1.3 | (6)<br>3.3         | (7a)<br>3.4                              | (7b)<br>3.5              | (8)<br>4.1.4     | (9)<br>4.1.4   | (10)<br>4.1.4     | (11)<br>4.1.4   |
| 1432   | SODIUM PHOSPHIDE           | 4.3               | 6.1                  | I              | –                  | 0  | E0                       | P403             | PP31           | –                 | –               |
| 1433   | STANNIC PHOSPHIDE          | 4.3               | 6.1                  | I              | –                  | 0  | E0                       | P403             | PP31           | –                 | –               |
| 1435   | ZINC ASHES                 | 4.3               | –                    | III            | 223<br>935         | 1 kg                                     | E1                       | P002             | PP100          | IBC08             | B4              |
| 1436   | ZINC POWDER or ZINC DUST   | 4.3               | 4.2                  | I              | –                  | 0  | E0                       | P403             | PP31           | –                 | –               |
| 1436   | ZINC POWDER or ZINC DUST   | 4.3               | 4.2                  | II             | –                  | 0  | E2                       | P410             | PP31<br>PP40   | IBC07             | B21             |
| 1436   | ZINC POWDER or ZINC DUST   | 4.3               | 4.2                  | III            | 223                | 0  | E1                       | P410             | PP31           | IBC08             | B4              |
| 1437   | ZIRCONIUM HYDRIDE          | 4.1               | –                    | II             | –                  | 1 kg                                     | E2                       | P410             | PP31<br>PP40   | IBC04             | –               |
| 1438   | ALUMINIUM NITRATE          | 5.1               | –                    | III            | –                  | 5 kg                                     | E1                       | P002<br>LP02     | –              | IBC08             | B3              |
| 1439   | AMMONIUM DICHROMATE        | 5.1               | –                    | II             | –                  | 1 kg                                     | E2                       | P002             | –              | IBC08             | B4<br>B21       |
| 1442   | AMMONIUM PERCHLORATE       | 5.1               | –                    | II             | 152                | 1 kg                                     | E2                       | P002             | –              | IBC06             | B21             |
| 1444   | AMMONIUM PERSULPHATE       | 5.1               | –                    | III            | –                  | 5 kg                                     | E1                       | P002<br>LP02     | –              | IBC08             | B3              |
| 1445   | BARIUM CHLORATE, SOLID     | 5.1               | 6.1                  | II             | –                  | 1 kg                                     | E2                       | P002             | –              | IBC06             | B21             |
| 1446   | BARIUM NITRATE             | 5.1               | 6.1                  | II             | –                  | 1 kg                                     | E2                       | P002             | –              | IBC08             | B4<br>B21       |
| 1447   | BARIUM PERCHLORATE, SOLID  | 5.1               | 6.1                  | II             | –                  | 1 kg                                     | E2                       | P002             | –              | IBC06             | B21             |

| UN No. | Portable tanks and bulk containers |                 | EmS                    | Stowage and handling           | Segregation                           | Properties and observations   | UN No. |
|--------|------------------------------------|-----------------|------------------------|--------------------------------|---------------------------------------|---|--------|
|        | Tank instructions (12)             | Provisions (14) |                        |                                |                                       |   |        |
| (18)   | (13)<br>4.2.5<br>4.3               | (14)<br>4.2.5   | (15)<br>5.4.3.4<br>7.8 | (16a)<br>7.1<br>7.3–7.7        | (16b)<br>7.2–7.7                      | (17)  | (18)   |
| 1432   | –                                  | –               | F-G, S-N               | Category E<br>SW2<br>SW5<br>H1 | SG26<br>SG35                          | Solid. Reacts with acids or decomposes slowly in contact with water or damp air, evolving phosphine, a spontaneously flammable and highly toxic gas. Reacts violently with oxidizing substances. Toxic if swallowed, by skin contact or by inhalation.  | 1432   |
| 1433   | –                                  | –               | F-G, S-N               | Category E<br>SW2<br>SW5<br>H1 | SG26<br>SG35                          | Silver-white solid. Reacts with acids or decomposes slowly in contact with water or damp air, evolving phosphine, a spontaneously flammable and highly toxic gas. Reacts violently with oxidizing substances. Toxic if swallowed, by skin contact or by inhalation.   | 1433   |
| 1435   | T1<br>BK2                          | TP33            | F-G, S-O               | Category A<br>H1               | SGG7<br>SGG15<br>SG26                 | In contact with moisture or water, liable to evolve dangerous gases, including hydrogen, a flammable gas.   | 1435   |
| 1436   | –                                  | –               | F-G, S-O               | Category A<br>H1               | SGG7<br>SGG15<br>SG26<br>SG35<br>SG36 | In contact with water, alkalis or acids, evolves hydrogen, a flammable gas. Zinc dust is easily ignited, causing explosion. May explode when in contact with oxidizing substances.  | 1436   |
| 1436   | T3                                 | TP33            | F-G, S-O               | Category A<br>H1               | SGG7<br>SGG15<br>SG26<br>SG35<br>SG36 | See entry above.  | 1436   |
| 1436   | T1                                 | TP33            | F-G, S-O               | Category A<br>H1               | SGG7<br>SGG15<br>SG26<br>SG35<br>SG36 | See entry above.  | 1436   |
| 1437   | T3                                 | TP33            | F-A, S-G               | Category E                     | –                                     | Black coloured powder.  | 1437   |
| 1438   | T1<br>BK2                          | TP33            | F-A, S-Q               | Category A                     | –                                     | Colourless or white crystals. Deliquescent. Soluble in water. Slightly corrosive. Mixtures with combustible material are readily ignited and may burn fiercely. Harmful if swallowed.   | 1438   |
| 1439   | T3                                 | TP33            | F-H, S-Q               | Category A                     | SGG2<br>SG35                          | Orange needles. Soluble in water. Mixtures with combustible material are readily ignited and may burn fiercely. May ignite spontaneously in contact with acids. Harmful if swallowed.   | 1439   |
| 1442   | T3                                 | TP33            | F-H, S-Q               | Category E                     | SGG2<br>SGG13<br>SG49<br>SG60         | White crystals or powder. Soluble in water. When heated, decomposes readily, even with explosion, evolving toxic fumes. Forms highly explosive mixtures with combustible material or powdered metals. These mixtures are sensitive to friction and are liable to ignite.  | 1442   |
| 1444   | T1                                 | TP33            | F-A, S-Q               | Category A                     | SGG2                                  | White crystals or powder. Soluble in water. Mixtures with combustible material are sensitive to friction and are liable to ignite.  | 1444   |
| 1445   | T3                                 | TP33            | F-H, S-Q               | Category A                     | SGG4<br>SG38<br>SG49                  | Colourless crystals or powder. Reacts vigorously with sulphuric acid. Reacts fiercely with cyanides when heated or by friction. May form explosive mixtures with combustible material, powdered metals or ammonium compounds. These mixtures are sensitive to friction and are liable to ignite. When involved in a fire, may cause an explosion. Toxic if swallowed, by skin contact or by dust inhalation.              | 1445   |
| 1446   | T3                                 | TP33            | F-A, S-Q               | Category A                     | –                                     | White crystals. Mixtures with combustible material are readily ignited and may burn fiercely. Toxic if swallowed, by skin contact or by dust inhalation.  | 1446   |
| 1447   | T3                                 | TP33            | F-H, S-Q               | Category A                     | SGG13<br>SG38<br>SG49                 | White crystals or powder, soluble in water. Reacts vigorously with sulphuric acid. Reacts fiercely with cyanides when heated or by friction. May form explosive mixtures with combustible material, powdered metals or ammonium compounds. These mixtures are sensitive to friction and are liable to ignite. When involved in a fire, may cause an explosion. Toxic if swallowed, by skin contact or by dust inhalation. | 1447   |



Part 3 – Dangerous Goods List, special provisions and exceptions

Chapter 3.2 – Dangerous Goods List

| UN No. | Proper shipping name (PSN)  | Class or division | Subsidiary hazard(s) | Packing group  | Special provisions | Limited and excepted quantity provisions |                     | Packing      |              | IBC           |               |
|--------|-----------------------------|-------------------|----------------------|----------------|--------------------|--|---------------------|--------------|--------------|---------------|---------------|
|        |                             |                   |                      |                |                    | Limited quantities                       | Excepted quantities | Instructions | Provisions   | Instructions  | Provisions    |
| (1)    | (2)<br>3.1.2                | (3)<br>2.0        | (4)<br>2.0           | (5)<br>2.0.1.3 | (6)<br>3.3         | (7a)<br>3.4                              | (7b)<br>3.5         | (8)<br>4.1.4 | (9)<br>4.1.4 | (10)<br>4.1.4 | (11)<br>4.1.4 |
| 1448   | BARIUM PERMANGANATE         | 5.1               | 6.1                  | II             | –                  | 1 kg                                     | E2                  | P002         | –            | IBC06         | B21           |
| 1449   | BARIUM PEROXIDE             | 5.1               | 6.1                  | II             | –                  | 1 kg                                     | E2                  | P002         | PP100        | IBC06         | B21           |
| 1450   | BROMATES, INORGANIC, N.O.S. | 5.1               | –                    | II             | 274<br>350         | 1 kg                                     | E2                  | P002         | –            | IBC08         | B4<br>B21     |
| 1451   | CAESIUM NITRATE             | 5.1               | –                    | III            | –                  | 5 kg                                     | E1                  | P002<br>LP02 | –            | IBC08         | B3            |
| 1452   | CALCIUM CHLORATE            | 5.1               | –                    | II             | –                  | 1 kg                                     | E2                  | P002         | –            | IBC08         | B4<br>B21     |
| 1453   | CALCIUM CHLORITE            | 5.1               | –                    | II             | –                  | 1 kg                                     | E2                  | P002         | –            | IBC08         | B4<br>B21     |
| 1454   | CALCIUM NITRATE             | 5.1               | –                    | III            | 208<br>967         | 5 kg                                     | E1                  | P002<br>LP02 | –            | IBC08         | B3            |
| 1455   | CALCIUM PERCHLORATE         | 5.1               | –                    | II             | –                  | 1 kg                                     | E2                  | P002         | –            | IBC06         | B21           |
| 1456   | CALCIUM PERMANGANATE        | 5.1               | –                    | II             | –                  | 1 kg                                     | E2                  | P002         | –            | IBC06         | B21           |
| 1457   | CALCIUM PEROXIDE            | 5.1               | –                    | II             | –                  | 1 kg                                     | E2                  | P002         | PP100        | IBC06         | B21           |
| 1458   | CHLORATE AND BORATE MIXTURE | 5.1               | –                    | II             | –                  | 1 kg                                     | E2                  | P002         | –            | IBC08         | B4<br>B21     |
| 1458   | CHLORATE AND BORATE MIXTURE | 5.1               | –                    | III            | 223                | 5 kg                                     | E1                  | P002<br>LP02 | –            | IBC08         | B3            |

| UN No. | Portable tanks and bulk containers |               | EmS                    | Stowage and handling    | Segregation                           | Properties and observations   | UN No. |
|--------|------------------------------------|---------------|------------------------|-------------------------|---------------------------------------|---|--------|
|        | Tank instructions                  | Provisions    |                        |                         |                                       |   |        |
| (12)   | (13)<br>4.2.5<br>4.3               | (14)<br>4.2.5 | (15)<br>5.4.3.4<br>7.8 | (16a)<br>7.1<br>7.3–7.7 | (16b)<br>7.2–7.7                      | (17)  | (18)   |
| –      | T3                                 | TP33          | F-H, S-Q               | Category D              | SGG14<br>SG38<br>SG49<br>SG60         | Brownish-violet crystals. Soluble in water. Reacts vigorously with sulphuric acid and hydrogen peroxide. Reacts fiercely with cyanides when heated or by friction. May form explosive mixtures with combustible material, powdered metals or ammonium compounds. These mixtures are sensitive to friction and are liable to ignite. When involved in a fire, may cause an explosion. Toxic if swallowed, by skin contact or by dust inhalation. | 1448   |
| –      | T3                                 | TP33          | F-G, S-Q               | Category C<br>H1        | SGG16<br>SG16<br>SG26<br>SG35<br>SG59 | White powder. Particularly if wetted with small quantities of water, a mixture with combustible material may ignite following impact or friction. When involved in a fire, or in contact with water or acids, decomposes, evolving oxygen. Toxic if swallowed, by skin contact or by dust inhalation.   | 1449   |
| –      | T3                                 | TP33          | F-H, S-Q               | Category A              | SGG3<br>SG38<br>SG49                  | Solids. React vigorously with sulphuric acid. React fiercely with cyanides when heated or by friction, and may form explosive mixtures with combustible material, powdered metals or ammonium compounds. These mixtures are sensitive to friction and are liable to ignite. When involved in a fire, may cause an explosion. Transport of ammonium bromate and mixtures of a bromate with an ammonium salt is prohibited.                       | 1450   |
| –      | T1                                 | TP33          | F-A, S-Q               | Category A              | –                                     | White powder. Mixtures with combustible material are readily ignited and may burn fiercely. Harmful if swallowed.   | 1451   |
| –      | T3                                 | TP33          | F-H, S-Q               | Category A              | SGG4<br>SG38<br>SG49                  | White to yellowish deliquescent crystals. Soluble in water. Reacts vigorously with sulphuric acid. Reacts fiercely with cyanides when heated or by friction. May form explosive mixtures with combustible material, powdered metals or ammonium compounds. These mixtures are sensitive to friction and are liable to ignite. When involved in a fire, may cause an explosion.  | 1452   |
| –      | T3                                 | TP33          | F-H, S-Q               | Category A              | SGG5<br>SG38<br>SG49                  | White deliquescent crystals. Soluble in water. Sensitive to heat. Reacts vigorously with sulphuric acid. Reacts fiercely with cyanides when heated or by friction. May form explosive mixtures with combustible material, powdered metals or ammonium compounds. These mixtures are sensitive to friction and are liable to ignite. When involved in a fire, may cause an explosion.  | 1453   |
| –      | T1<br>BK2<br>BK3                   | TP33          | F-A, S-Q               | Category A<br>SW23      | –                                     | White deliquescent solid, soluble in water. Mixtures with combustible material are readily ignited and may burn fiercely. Harmful if swallowed.   | 1454   |
| –      | T3                                 | TP33          | F-H, S-Q               | Category A              | SGG13<br>SG38<br>SG49                 | White crystals or powder. Reacts vigorously with sulphuric acid. Reacts fiercely with cyanides when heated or by friction. May form explosive mixtures with combustible material, powdered metals or ammonium compounds. These mixtures are sensitive to friction and are liable to ignite. When involved in a fire, may cause an explosion.  | 1455   |
| –      | T3                                 | TP33          | F-H, S-Q               | Category D              | SGG14<br>SG38<br>SG49<br>SG60         | Violet deliquescent crystals. Soluble in water. Occurs in hydrated form. Reacts vigorously with sulphuric acid and hydrogen peroxide. Reacts fiercely with cyanides when heated or by friction. May form explosive mixtures with combustible material, powdered metals or ammonium compounds. These mixtures are sensitive to friction and are liable to ignite. When involved in a fire, may cause an explosion.                               | 1456   |
| –      | T3                                 | TP33          | F-G, S-Q               | Category C<br>H1        | SGG16<br>SG16<br>SG26<br>SG35<br>SG59 | White or yellowish powder. Particularly if wetted with small quantities of water, a mixture with combustible material may ignite following impact or friction. When involved in a fire, or on contact with water or acids, decomposes, evolving oxygen.   | 1457   |
| –      | T3                                 | TP33          | F-H, S-Q               | Category A              | SGG4<br>SG38<br>SG49                  | Solid. Reacts vigorously with sulphuric acid. Reacts fiercely with cyanides when heated or by friction. May form explosive mixtures with combustible material, powdered metals or ammonium compounds. These mixtures are sensitive to friction and are liable to ignite. When involved in a fire, may cause an explosion.   | 1458   |
| –      | T1                                 | TP33          | F-H, S-Q               | Category A              | SGG4<br>SG38<br>SG49                  | See entry above.  | 1458   |

Part 3 – Dangerous Goods List, special provisions and exceptions

Chapter 3.2 – Dangerous Goods List

| UN No. | Proper shipping name (PSN)                                | Class or division | Subsidiary hazard(s) | Packing group  | Special provisions | Limited and excepted quantity provisions |                     | Packing      |              | IBC           |               |
|--------|---|-------------------|----------------------|----------------|--------------------|--|---------------------|--------------|--------------|---------------|---------------|
|        |   |                   |                      |                |                    | Limited quantities                       | Excepted quantities | Instructions | Provisions   | Instructions  | Provisions    |
| (1)    | (2)<br>3.1.2  | (3)<br>2.0        | (4)<br>2.0           | (5)<br>2.0.1.3 | (6)<br>3.3         | (7a)<br>3.4                              | (7b)<br>3.5         | (8)<br>4.1.4 | (9)<br>4.1.4 | (10)<br>4.1.4 | (11)<br>4.1.4 |
| 1459   | CHLORATE AND MAGNESIUM CHLORIDE MIXTURE, SOLID            | 5.1               | –                    | II             | –                  | 1 kg                                     | E2                  | P002         | –            | IBC08         | B4<br>B21     |
| 1459   | CHLORATE AND MAGNESIUM CHLORIDE MIXTURE, SOLID            | 5.1               | –                    | III            | 223                | 5 kg                                     | E1                  | P002<br>LP02 | –            | IBC08         | B3            |
| 1461   | CHLORATES, INORGANIC, N.O.S.                              | 5.1               | –                    | II             | 274<br>351         | 1 kg                                     | E2                  | P002         | –            | IBC06         | B21           |
| 1462   | CHLORITES, INORGANIC, N.O.S.                              | 5.1               | –                    | II             | 274<br>352         | 1 kg                                     | E2                  | P002         | –            | IBC06         | B21           |
| 1463   | CHROMIUM TRIOXIDE, ANHYDROUS                              | 5.1               | 6.1/8                | II             | –                  | 1 kg                                     | E2                  | P002         | PP31         | IBC08         | B4<br>B21     |
| 1465   | DIDYMIUM NITRATE  | 5.1               | –                    | III            | –                  | 5 kg                                     | E1                  | P002<br>LP02 | –            | IBC08         | B3            |
| 1466   | FERRIC NITRATE  | 5.1               | –                    | III            | –                  | 5 kg                                     | E1                  | P002<br>LP02 | –            | IBC08         | B3            |
| 1467   | GUANIDINE NITRATE   | 5.1               | –                    | III            | –                  | 5 kg                                     | E1                  | P002<br>LP02 | –            | IBC08         | B3            |
| 1469   | LEAD NITRATE  | 5.1               | 6.1<br>P             | II             | –                  | 1 kg                                     | E2                  | P002         | –            | IBC08         | B4<br>B21     |
| 1470   | LEAD PERCHLORATE, SOLID                                   | 5.1               | 6.1<br>P             | II             | –                  | 1 kg                                     | E2                  | P002         | –            | IBC06         | B21           |
| 1471   | LITHIUM HYPOCHLORITE, DRY or LITHIUM HYPOCHLORITE MIXTURE | 5.1               | –                    | II             | –                  | 1 kg                                     | E2                  | P002         | –            | IBC08         | B4<br>B21     |
| 1471   | LITHIUM HYPOCHLORITE, DRY or LITHIUM HYPOCHLORITE MIXTURE | 5.1               | –                    | III            | 223                | 5 kg                                     | E1                  | P002<br>LP02 | –            | IBC08         | B3            |

| UN No. | Portable tanks and bulk containers |               | EmS                    | Stowage and handling     | Segregation                                  | Properties and observations   | UN No. |
|--------|------------------------------------|---------------|------------------------|--------------------------|--|---|--------|
|        | Tank instructions                  | Provisions    |                        |                          |  |   |        |
| (12)   | (13)<br>4.2.5<br>4.3               | (14)<br>4.2.5 | (15)<br>5.4.3.4<br>7.8 | (16a)<br>7.1<br>7.3–7.7  | (16b)<br>7.2–7.7                             | (17)  | (18)   |
| –      | T3                                 | TP33          | F-H, S-Q               | Category A               | SGG4<br>SG38<br>SG49                         | Deliquescent solid. Reacts vigorously with sulphuric acid. Reacts fiercely with cyanides when heated or by friction. May form explosive mixtures with combustible material, powdered metals or ammonium compounds. These mixtures are sensitive to friction and are liable to ignite. When involved in a fire, may cause an explosion.  | 1459   |
| –      | T1                                 | TP33          | F-H, S-Q               | Category A               | SGG4<br>SG38<br>SG49                         | See entry above.  | 1459   |
| –      | T3                                 | TP33          | F-H, S-Q               | Category A               | SGG4<br>SG38<br>SG49                         | Solids. React vigorously with sulphuric acid. React fiercely with cyanides when heated or by friction. May form explosive mixtures with combustible material, powdered metals or ammonium compounds. These mixtures are sensitive to friction and are liable to ignite. When involved in a fire, may cause an explosion. Transport of ammonium chlorate and mixtures of a chlorate with an ammonium salt is prohibited.   | 1461   |
| –      | T3                                 | TP33          | F-H, S-Q               | Category A               | SGG5<br>SG38<br>SG49                         | Solids. React vigorously with sulphuric acid. React fiercely with cyanides when heated or by friction. May form explosive mixtures with combustible material, powdered metals or ammonium compounds. These mixtures are sensitive to friction and are liable to ignite. When involved in a fire, may cause an explosion. Transport of ammonium chlorite and mixtures of a chlorite with an ammonium salt is prohibited.   | 1462   |
| –      | T3                                 | TP33          | F-A, S-Q               | Category A               | SG6<br>SG16<br>SG19                          | Dark purplish-red deliquescent crystals. Soluble in water. Mixtures with combustible material may ignite spontaneously and may even explode. In the presence of moisture, corrosive to most metals. Causes burns to skin, eyes and mucous membranes.  | 1463   |
| –      | T1                                 | TP33          | F-A, S-Q               | Category A               | –  | Hygroscopic solid. Mixture of neodymium nitrate and praseodymium nitrate. Mixtures with combustible material are readily ignited and may burn fiercely. Harmful if swallowed.   | 1465   |
| –      | T1                                 | TP33          | F-A, S-Q               | Category A               | –  | Violet deliquescent crystals. Soluble in water. Melting point: 47°C. Mixtures with combustible material are readily ignited and may burn fiercely. Solutions in water are slightly corrosive to most metals. Harmful if swallowed.  | 1466   |
| –      | T1                                 | TP33          | F-A, S-Q               | Category A               | SG45   | White granules. Soluble in water. Mixtures with combustible material are sensitive to friction and are liable to ignite. NITROGUANIDINE is a different substance.   | 1467   |
| –      | T3                                 | TP33          | F-A, S-Q               | Category A               | SGG7<br>SGG9                                 | White crystals. Soluble in water. Mixtures with combustible material are readily ignited and may burn fiercely. Toxic if swallowed, by skin contact or by dust inhalation.  | 1469   |
| –      | T3                                 | TP33          | F-H, S-Q               | Category A               | SGG7<br>SGG9<br>SG13<br>SG38<br>SG49         | White crystals or powder. Soluble in water. Reacts vigorously with sulphuric acid. Reacts fiercely with cyanides when heated or by friction. May form explosive mixtures with combustible material, powdered metals or ammonium compounds. These mixtures are sensitive to friction and are liable to ignite. When involved in a fire, may cause an explosion. Toxic if swallowed, by skin contact or by dust inhalation. | 1470   |
| –      | T3                                 | TP33          | F-H, S-Q               | Category A<br>SW1<br>SW8 | SGG8<br>SG35<br>SG38<br>SG49<br>SG53<br>SG60 | White powder with pungent odour. Soluble in water. Critical ambient temperature of decomposition may be as low as 60°C. May cause fire in contact with organic material or ammonium compounds. Reacts with acids, evolving chlorine, an irritating, corrosive and toxic gas. In the presence of moisture, corrosive to most metals. Dust irritates mucous membranes.  | 1471   |
| –      | T1                                 | TP33          | F-H, S-Q               | Category A<br>SW1<br>SW8 | SGG8<br>SG35<br>SG38<br>SG49<br>SG53<br>SG60 | See entry above.  | 1471   |

Part 3 – Dangerous Goods List, special provisions and exceptions

Chapter 3.2 – Dangerous Goods List

| UN No. | Proper shipping name (PSN)       | Class or division | Subsidiary hazard(s) | Packing group  | Special provisions | Limited and excepted quantity provisions |                     | Packing      |              | IBC           |               |
|--------|----------------------------------|-------------------|----------------------|----------------|--------------------|--|---------------------|--------------|--------------|---------------|---------------|
|        |                                  |                   |                      |                |                    | Limited quantities                       | Excepted quantities | Instructions | Provisions   | Instructions  | Provisions    |
| (1)    | (2)<br>3.1.2                     | (3)<br>2.0        | (4)<br>2.0           | (5)<br>2.0.1.3 | (6)<br>3.3         | (7a)<br>3.4                              | (7b)<br>3.5         | (8)<br>4.1.4 | (9)<br>4.1.4 | (10)<br>4.1.4 | (11)<br>4.1.4 |
| 1472   | LITHIUM PEROXIDE                 | 5.1               | –                    | II             | –                  | 1 kg                                     | E2                  | P002         | PP100        | IBC06         | B21           |
| 1473   | MAGNESIUM BROMATE                | 5.1               | –                    | II             | –                  | 1 kg                                     | E2                  | P002         | –            | IBC08         | B4<br>B21     |
| 1474   | MAGNESIUM NITRATE                | 5.1               | –                    | III            | 332<br>967         | 5 kg                                     | E1                  | P002<br>LP02 | –            | IBC08         | B3            |
| 1475   | MAGNESIUM PERCHLORATE            | 5.1               | –                    | II             | –                  | 1 kg                                     | E2                  | P002         | –            | IBC06         | B21           |
| 1476   | MAGNESIUM PEROXIDE               | 5.1               | –                    | II             | –                  | 1 kg                                     | E2                  | P002         | PP100        | IBC06         | B21           |
| 1477   | NITRATES, INORGANIC, N.O.S.      | 5.1               | –                    | II             | –                  | 1 kg                                     | E2                  | P002         | –            | IBC08         | B4<br>B21     |
| 1477   | NITRATES, INORGANIC, N.O.S.      | 5.1               | –                    | III            | 223                | 5 kg                                     | E1                  | P002<br>LP02 | –            | IBC08         | B3            |
| 1479   | OXIDIZING SOLID, N.O.S.          | 5.1               | –                    | I              | 274<br>900         | 0  | E0                  | P503         | –            | IBC05         | B1            |
| 1479   | OXIDIZING SOLID, N.O.S.          | 5.1               | –                    | II             | 274<br>900         | 1 kg                                     | E2                  | P002         | –            | IBC08         | B4<br>B21     |
| 1479   | OXIDIZING SOLID, N.O.S.          | 5.1               | –                    | III            | 223<br>274<br>900  | 5 kg                                     | E1                  | P002<br>LP02 | –            | IBC08         | B3            |
| 1481   | PERCHLORATES, INORGANIC, N.O.S.  | 5.1               | –                    | II             | –                  | 1 kg                                     | E2                  | P002         | –            | IBC06         | B21           |
| 1481   | PERCHLORATES, INORGANIC, N.O.S.  | 5.1               | –                    | III            | 223                | 5 kg                                     | E1                  | P002<br>LP02 | –            | IBC08         | B3            |
| 1482   | PERMANGANATES, INORGANIC, N.O.S. | 5.1               | –                    | II             | 274<br>353         | 1 kg                                     | E2                  | P002         | –            | IBC06         | B21           |
| 1482   | PERMANGANATES, INORGANIC, N.O.S. | 5.1               | –                    | III            | 223<br>274<br>353  | 5 kg                                     | E1                  | P002         | –            | IBC08         | B3            |

| UN No. | Portable tanks and bulk containers |               | EmS                    | Stowage and handling    | Segregation                           | Properties and observations   | UN No. |
|--------|------------------------------------|---------------|------------------------|-------------------------|---------------------------------------|---|--------|
|        | Tank instructions                  | Provisions    |                        |                         |                                       |   |        |
| (12)   | (13)<br>4.2.5<br>4.3               | (14)<br>4.2.5 | (15)<br>5.4.3.4<br>7.8 | (16a)<br>7.1<br>7.3–7.7 | (16b)<br>7.2–7.7                      | (17)  | (18)   |
| –      | T3                                 | TP33          | F-G, S-Q               | Category C<br>H1        | SGG16<br>SG16<br>SG26<br>SG35<br>SG59 | White powder. Soluble in water. Solution in water is an alkaline corrosive liquid. Particularly if wetted with small quantities of water, a mixture with combustible material may ignite following impact or friction. When involved in a fire, or in contact with water or acids, decomposes, evolving oxygen.   | 1472   |
| –      | T3                                 | TP33          | F-H, S-Q               | Category A              | SGG3<br>SG38<br>SG49                  | White deliquescent crystals or crystalline powder. Soluble in water. Reacts vigorously with sulphuric acid. Reacts fiercely with cyanides when heated or by friction. May form explosive mixtures with combustible material, powdered metals or ammonium compounds. These mixtures are sensitive to friction and are liable to ignite. When involved in a fire, may cause an explosion.   | 1473   |
| –      | T1<br>BK2<br>BK3                   | TP33          | F-A, S-Q               | Category A<br>SW23      | –                                     | White deliquescent crystals, soluble in water. Mixtures with combustible material are readily ignited and may burn fiercely. Harmful if swallowed.  | 1474   |
| –      | T3                                 | TP33          | F-H, S-Q               | Category A              | SGG13<br>SG38<br>SG49                 | White crystals or powder. Reacts vigorously with sulphuric acid. Reacts fiercely with cyanides when heated or by friction. May form explosive mixtures with combustible material, powdered metals or ammonium compounds. These mixtures are sensitive to friction and are liable to ignite. When involved in a fire, may cause an explosion.  | 1475   |
| –      | T3                                 | TP33          | F-G, S-Q               | Category C<br>H1        | SGG16<br>SG16<br>SG26<br>SG35<br>SG59 | White powder. Particularly if wetted with small quantities of water, a mixture with combustible material may ignite following impact or friction. When involved in a fire, or in contact with water or acids, decomposes, evolving oxygen. Harmful if swallowed.  | 1476   |
| –      | T3                                 | TP33          | F-A, S-Q               | Category A              | SG38<br>SG49                          | Solids. Solid mixtures with combustible material are readily ignited and may burn fiercely. Harmful if swallowed.   | 1477   |
| –      | T1                                 | TP33          | F-A, S-Q               | Category A              | SG38<br>SG49                          | See entry above.  | 1477   |
| –      | –                                  | –             | F-A, S-Q               | Category D              | SG38<br>SG49<br>SG60<br>SG61          | –   | 1479   |
| –      | T3                                 | TP33          | F-A, S-Q               | Category B              | SG38<br>SG49<br>SG60<br>SG61          | –   | 1479   |
| –      | T1                                 | TP33          | F-A, S-Q               | Category B              | SG38<br>SG49<br>SG60<br>SG61          | –   | 1479   |
| –      | T3                                 | TP33          | F-H, S-Q               | Category A              | SGG13<br>SG38<br>SG49                 | Solids. React vigorously with sulphuric acid. React fiercely with cyanides when heated or by friction. May form explosive mixtures with combustible material, powdered metals or ammonium compounds. These mixtures are sensitive to friction and are liable to ignite. When involved in a fire, may cause an explosion.  | 1481   |
| –      | T1                                 | TP33          | F-H, S-Q               | Category A              | SGG13<br>SG38<br>SG49                 | See entry above.  | 1481   |
| –      | T3                                 | TP33          | F-H, S-Q               | Category D              | SGG14<br>SG38<br>SG49<br>SG60         | Solids. React vigorously with sulphuric acid. React fiercely with cyanides when heated or by friction. May form explosive mixtures with combustible material, powdered metals or ammonium compounds. These mixtures are sensitive to friction and are liable to ignite. When involved in a fire, may cause an explosion. Transport of ammonium permanganate and mixtures of a permanganate with an ammonium salt is <b>prohibited</b> . | 1482   |
| –      | T1                                 | TP33          | F-H, S-Q               | Category D              | SGG14<br>SG38<br>SG49<br>SG60         | See entry above.  | 1482   |



Part 3 – Dangerous Goods List, special provisions and exceptions

Chapter 3.2 – Dangerous Goods List

| UN No. | Proper shipping name (PSN)                   | Class or division | Subsidiary hazard(s) | Packing group  | Special provisions | Limited and excepted quantity provisions |                     | Packing      |              | IBC           |               |
|--------|--|-------------------|----------------------|----------------|--------------------|--|---------------------|--------------|--------------|---------------|---------------|
|        |  |                   |                      |                |                    | Limited quantities                       | Excepted quantities | Instructions | Provisions   | Instructions  | Provisions    |
| (1)    | (2)<br>3.1.2                                 | (3)<br>2.0        | (4)<br>2.0           | (5)<br>2.0.1.3 | (6)<br>3.3         | (7a)<br>3.4                              | (7b)<br>3.5         | (8)<br>4.1.4 | (9)<br>4.1.4 | (10)<br>4.1.4 | (11)<br>4.1.4 |
| 1483   | PEROXIDES, INORGANIC, N.O.S.                 | 5.1               | –                    | II             | –                  | 1 kg                                     | E2                  | P002         | PP100        | IBC06         | B21           |
| 1483   | PEROXIDES, INORGANIC, N.O.S.                 | 5.1               | –                    | III            | 223                | 5 kg                                     | E1                  | P002 LP02    | PP100 L3     | IBC08         | B4            |
| 1484   | POTASSIUM BROMATE                            | 5.1               | –                    | II             | –                  | 1 kg                                     | E2                  | P002         | –            | IBC08         | B4 B21        |
| 1485   | POTASSIUM CHLORATE                           | 5.1               | –                    | II             | –                  | 1 kg                                     | E2                  | P002         | –            | IBC08         | B4 B21        |
| 1486   | POTASSIUM NITRATE                            | 5.1               | –                    | III            | 964 967            | 5 kg                                     | E1                  | P002 LP02    | –            | IBC08         | B3            |
| 1487   | POTASSIUM NITRATE AND SODIUM NITRITE MIXTURE | 5.1               | –                    | II             | –                  | 1 kg                                     | E2                  | P002         | –            | IBC08         | B4 B21        |
| 1488   | POTASSIUM NITRITE                            | 5.1               | –                    | II             | –                  | 1 kg                                     | E2                  | P002         | –            | IBC08         | B4 B21        |
| 1489   | POTASSIUM PERCHLORATE                        | 5.1               | –                    | II             | –                  | 1 kg                                     | E2                  | P002         | –            | IBC06         | B21           |
| 1490   | POTASSIUM PERMANGANATE                       | 5.1               | –                    | II             | –                  | 1 kg                                     | E2                  | P002         | –            | IBC08         | B4 B21        |
| 1491   | POTASSIUM PEROXIDE                           | 5.1               | –                    | I              | –                  | 0  | E0                  | P503         | –            | IBC06         | B1            |
| 1492   | POTASSIUM PERSULPHATE                        | 5.1               | –                    | III            | –                  | 5 kg                                     | E1                  | P002 LP02    | –            | IBC08         | B3            |
| 1493   | SILVER NITRATE                               | 5.1               | –                    | II             | –                  | 1 kg                                     | E2                  | P002         | –            | IBC08         | B4 B21        |

| UN No. | Portable tanks and bulk containers |               | EmS                    | Stowage and handling    | Segregation                           | Properties and observations  | UN No. |
|--------|------------------------------------|---------------|------------------------|-------------------------|---------------------------------------|--|--------|
|        | Tank instructions                  | Provisions    |                        |                         |                                       |  |        |
| (12)   | (13)<br>4.2.5<br>4.3               | (14)<br>4.2.5 | (15)<br>5.4.3.4<br>7.8 | (16a)<br>7.1<br>7.3–7.7 | (16b)<br>7.2–7.7                      | (17)   | (18)   |
| –      | T3                                 | TP33          | F-G, S-Q               | Category C H1           | SGG16<br>SG16<br>SG26<br>SG35<br>SG59 | Particularly if wetted with small quantities of water, a mixture with combustible material may ignite following impact or friction. When involved in a fire, or in contact with water or acids, decomposes, evolving oxygen.   | 1483   |
| –      | T1                                 | TP33          | F-G, S-Q               | Category C H1           | SGG16<br>SG16<br>SG26<br>SG35<br>SG59 | See entry above.   | 1483   |
| –      | T3                                 | TP33          | F-H, S-Q               | Category A              | SGG3<br>SG38<br>SG49                  | White crystals or powder. Soluble in water. Reacts vigorously with sulphuric acid. Reacts fiercely with cyanides when heated or by friction. May form explosive mixtures with combustible materials, powdered metals or ammonium compounds. These mixtures are sensitive to friction and are liable to ignite. When involved in a fire, may cause an explosion.                            | 1484   |
| –      | T3                                 | TP33          | F-H, S-Q               | Category A              | SGG4<br>SG38<br>SG49                  | White crystals or powder. Soluble in water. Reacts vigorously with sulphuric acid. Reacts fiercely with cyanides when heated or by friction. May form explosive mixtures with combustible material, powdered metals or ammonium compounds. These mixtures are sensitive to friction and are liable to ignite. When involved in a fire, may cause an explosion.                             | 1485   |
| –      | T1<br>BK2<br>BK3                   | TP33          | F-A, S-Q               | Category A SW23         | –                                     | White crystals or powder. Soluble in water. Mixtures with combustible material are readily ignited and may burn fiercely. Harmful if swallowed.  | 1486   |
| –      | T3                                 | TP33          | F-A, S-Q               | Category A              | SGG12<br>SG38<br>SG49                 | Deliquescent solid. Soluble in water. May cause fire in contact with organic material such as wood, cotton or straw. Mixtures with ammonium compounds or cyanides may explode. Harmful if swallowed. May be shipped in the form of fused solid block or lumps.   | 1487   |
| –      | T3                                 | TP33          | F-A, S-Q               | Category A              | SGG12<br>SG38<br>SG49                 | White or slightly yellowish deliquescent crystals or sticks. Soluble in water. Mixtures with combustible material are readily ignited and may burn fiercely. Mixtures with ammonium compounds or cyanides may explode. Harmful if swallowed.   | 1488   |
| –      | T3                                 | TP33          | F-H, S-Q               | Category A              | SGG13<br>SG38<br>SG49                 | White crystals or powder, soluble in water. Reacts vigorously with sulphuric acid. Reacts fiercely with cyanides when heated or by friction. May form explosive mixtures with combustible material, powdered metals or ammonium compounds. These mixtures are sensitive to friction and are liable to ignite. When involved in a fire, may cause an explosion.                             | 1489   |
| –      | T3                                 | TP33          | F-H, S-Q               | Category D              | SGG14<br>SG38<br>SG49<br>SG60         | Dark purple crystals or powder. Soluble in water. Reacts vigorously with sulphuric acid and hydrogen peroxide. Reacts fiercely with cyanides when heated or by friction. May form explosive mixtures with combustible material, powdered metals or ammonium compounds. These mixtures are sensitive to friction and are liable to ignite. When involved in a fire, may cause an explosion. | 1490   |
| –      | –                                  | –             | F-G, S-Q               | Category C H1           | SGG16<br>SG16<br>SG26<br>SG35<br>SG59 | Yellow powder. Particularly if wetted with small quantities of water, a mixture with combustible material may ignite, following impact or friction. When involved in a fire, or in contact with water or acids, decomposes, evolving oxygen. Highly irritating to skin, eyes and mucous membranes.   | 1491   |
| –      | T1                                 | TP33          | F-A, S-Q               | Category A              | SG39<br>SG49                          | White crystals or powder. Soluble in water. Mixtures with combustible material are sensitive to friction and are liable to ignite. Reacts fiercely with cyanides when heated or by friction. May form explosive mixture with powdered metals or ammonium compounds.  | 1492   |
| –      | T3                                 | TP33          | F-A, S-Q               | Category A              | SGG7                                  | Colourless crystals. Soluble in water. Mixtures with combustible material are readily ignited and may burn fiercely. Harmful if swallowed. Irritating to skin and mucous membranes.  | 1493   |

| UN No. | Proper shipping name (PSN)                   | Class or division | Subsidiary hazard(s) | Packing group  | Special provisions | Limited and excepted quantity provisions |                     | Packing      |              | IBC           |               |
|--------|--|-------------------|----------------------|----------------|--------------------|--|---------------------|--------------|--------------|---------------|---------------|
|        |  |                   |                      |                |                    | Limited quantities                       | Excepted quantities | Instructions | Provisions   | Instructions  | Provisions    |
| (1)    | (2)<br>3.1.2                                 | (3)<br>2.0        | (4)<br>2.0           | (5)<br>2.0.1.3 | (6)<br>3.3         | (7a)<br>3.4                              | (7b)<br>3.5         | (8)<br>4.1.4 | (9)<br>4.1.4 | (10)<br>4.1.4 | (11)<br>4.1.4 |
| 1494   | SODIUM BROMATE                               | 5.1               | –                    | II             | –                  | 1 kg                                     | E2                  | P002         | –            | IBC08         | B4<br>B21     |
| 1495   | SODIUM CHLORATE                              | 5.1               | –                    | II             | –                  | 1 kg                                     | E2                  | P002         | –            | IBC08         | B4<br>B21     |
| 1496   | SODIUM CHLORITE                              | 5.1               | –                    | II             | –                  | 1 kg                                     | E2                  | P002         | –            | IBC08         | B4<br>B21     |
| 1498   | SODIUM NITRATE                               | 5.1               | –                    | III            | 964<br>967         | 5 kg                                     | E1                  | P002<br>LP02 | –            | IBC08         | B3            |
| 1499   | SODIUM NITRATE AND POTASSIUM NITRATE MIXTURE | 5.1               | –                    | III            | 964<br>967         | 5 kg                                     | E1                  | P002<br>LP02 | –            | IBC08         | B3            |
| 1500   | SODIUM NITRITE                               | 5.1               | 6.1                  | III            | –                  | 5 kg                                     | E1                  | P002         | –            | IBC08         | B3            |
| 1502   | SODIUM PERCHLORATE                           | 5.1               | –                    | II             | –                  | 1 kg                                     | E2                  | P002         | –            | IBC06         | B21           |
| 1503   | SODIUM PERMANGANATE                          | 5.1               | –                    | II             | –                  | 1 kg                                     | E2                  | P002         | –            | IBC06         | B21           |
| 1504   | SODIUM PEROXIDE                              | 5.1               | –                    | I              | –                  | 0  | E0                  | P503         | –            | IBC05         | B1            |
| 1505   | SODIUM PERSULPHATE                           | 5.1               | –                    | III            | –                  | 5 kg                                     | E1                  | P002<br>LP02 | –            | IBC08         | B3            |
| 1506   | STRONTIUM CHLORATE                           | 5.1               | –                    | II             | –                  | 1 kg                                     | E2                  | P002         | –            | IBC08         | B4<br>B21     |
| 1507   | STRONTIUM NITRATE                            | 5.1               | –                    | III            | –                  | 5 kg                                     | E1                  | P002<br>LP02 | –            | IBC08         | B3            |

| UN No. | Portable tanks and bulk containers |               | EmS                    | Stowage and handling    | Segregation                           | Properties and observations  | UN No. |
|--------|------------------------------------|---------------|------------------------|-------------------------|---------------------------------------|--|--------|
|        | Tank instructions                  | Provisions    |                        |                         |                                       |  |        |
| (12)   | (13)<br>4.2.5<br>4.3               | (14)<br>4.2.5 | (15)<br>5.4.3.4<br>7.8 | (16a)<br>7.1<br>7.3–7.7 | (16b)<br>7.2–7.7                      | (17)   | (18)   |
| –      | T3                                 | TP33          | F-H, S-Q               | Category A              | SGG3<br>SG38<br>SG49                  | White deliquescent crystals. Soluble in water. Reacts vigorously with sulphuric acid. Reacts fiercely with cyanides when heated or by friction. May form explosive mixtures with combustible material, powdered metals or ammonium compounds. These mixtures are sensitive to friction and are liable to ignite. When involved in a fire, may cause an explosion.                  | 1494   |
| –      | T3<br>BK2                          | TP33          | F-H, S-Q               | Category A              | SGG4<br>SG38<br>SG49                  | Colourless deliquescent crystals. Soluble in water. Reacts vigorously with sulphuric acid. Reacts fiercely with cyanides when heated or by friction. May form explosive mixtures with combustible material, powdered metals or ammonium compounds. These mixtures are sensitive to friction and are liable to ignite. When involved in a fire, may cause an explosion.             | 1495   |
| –      | T3                                 | TP33          | F-H, S-Q               | Category A              | SGG5<br>SG38<br>SG49                  | Colourless deliquescent solid. Soluble in water. Reacts vigorously with sulphuric acid. Reacts fiercely with cyanides when heated or by friction. May form explosive mixtures with combustible material, powdered metals or ammonium compounds. These mixtures are sensitive to friction and are liable to ignite. When involved in a fire, may cause an explosion.                | 1496   |
| –      | T1<br>BK2<br>BK3                   | TP33          | F-A, S-Q               | Category A<br>SW23      | –                                     | Colourless deliquescent solid. Soluble in water. Mixtures with combustible material are readily ignited and may burn fiercely. Harmful if swallowed. This substance in the impure form is known as Chile Saltpetre.  | 1498   |
| –      | T1<br>BK2<br>BK3                   | TP33          | F-A, S-Q               | Category A<br>SW23      | –                                     | Colourless, hygroscopic solid. Soluble in water. Mixtures with combustible material are readily ignited and may burn fiercely. Harmful if swallowed. Mixture prepared as a fertilizer.   | 1499   |
| –      | T1                                 | TP33          | F-A, S-Q               | Category A              | SGG12<br>SG38<br>SG49                 | Colourless deliquescent solid. Soluble in water. Mixtures with combustible material are readily ignited and may burn fiercely. Mixtures with ammonium compounds or cyanides may explode. Decomposes if heated, giving off toxic nitrous fumes and gases supporting combustion. Harmful if swallowed or by dust inhalation.   | 1500   |
| –      | T3                                 | TP33          | F-H, S-Q               | Category A              | SGG13<br>SG38<br>SG49                 | Colourless crystals or powder, soluble in water. Reacts vigorously with sulphuric acid. Reacts fiercely with cyanides when heated or by friction. May form explosive mixtures with combustible material, powdered metals or ammonium compounds. These mixtures are sensitive to friction and are liable to ignite. When involved in a fire, may cause an explosion.                | 1502   |
| –      | T3                                 | TP33          | F-H, S-Q               | Category D              | SGG14<br>SG38<br>SG49<br>SG60         | Red crystals or powder. Soluble in water. Reacts vigorously with sulphuric acid and hydrogen peroxide. Reacts fiercely with cyanides when heated or by friction. May form explosive mixtures with combustible material, powdered metals or ammonium compounds. These mixtures are sensitive to friction and are liable to ignite. When involved in a fire, may cause an explosion. | 1503   |
| –      | –                                  | –             | F-G, S-Q               | Category C<br>H1        | SGG16<br>SG16<br>SG26<br>SG35<br>SG59 | Pale yellow coarse powder or granules. Particularly if wetted with small quantities of water, a mixture with combustible material may ignite, following impact or friction. When involved in a fire, or in contact with water or acids, decomposes, evolving oxygen. Highly irritating to skin, eyes and mucous membranes.   | 1504   |
| –      | T1                                 | TP33          | F-A, S-Q               | Category A              | SG39<br>SG49                          | Colourless crystals or powder. Soluble in water. Mixtures with combustible material are sensitive to friction and are liable to ignite. Reacts fiercely with cyanides when heated or by friction. May form explosive mixture with powdered metals or ammonium compounds.   | 1505   |
| –      | T3                                 | TP33          | F-H, S-Q               | Category A              | SGG4<br>SG38<br>SG49                  | Colourless deliquescent solid, soluble in water. Reacts vigorously with sulphuric acid. Reacts fiercely with cyanides when heated or by friction. May form explosive mixtures with combustible material, powdered metals or ammonium compounds. These mixtures are sensitive to friction and are liable to ignite. When involved in a fire, may cause an explosion.                | 1506   |
| –      | T1                                 | TP33          | F-A, S-Q               | Category A              | –                                     | Colourless solid. Soluble in water. Mixtures with combustible material are readily ignited and may burn fiercely. Harmful if swallowed.  | 1507   |

| UN No. | Proper shipping name (PSN)  | Class or division | Subsidiary hazard(s) | Packing group  | Special provisions | Limited and excepted quantity provisions |                     | Packing      |              | IBC           |               |
|--------|---|-------------------|----------------------|----------------|--------------------|--|---------------------|--------------|--------------|---------------|---------------|
|        |   |                   |                      |                |                    | Limited quantities                       | Excepted quantities | Instructions | Provisions   | Instructions  | Provisions    |
| (1)    | (2)<br>3.1.2  | (3)<br>2.0        | (4)<br>2.0           | (5)<br>2.0.1.3 | (6)<br>3.3         | (7a)<br>3.4                              | (7b)<br>3.5         | (8)<br>4.1.4 | (9)<br>4.1.4 | (10)<br>4.1.4 | (11)<br>4.1.4 |
| 1508   | STRONTIUM PERCHLORATE   | 5.1               | –                    | II             | –                  | 1 kg                                     | E2                  | P002         | –            | IBC06         | B21           |
| 1509   | STRONTIUM PEROXIDE  | 5.1               | –                    | II             | –                  | 1 kg                                     | E2                  | P002         | PP100        | IBC06         | B21           |
| 1510   | TETRANITROMETHANE   | 6.1               | 5.1                  | I              | 354                | 0  | E0                  | P602         | –            | –             | –             |
| 1511   | UREA HYDROGEN PEROXIDE  | 5.1               | 8                    | III            | –                  | 5 kg                                     | E1                  | P002         | –            | IBC08         | B3            |
| 1512   | ZINC AMMONIUM NITRITE   | 5.1               | –                    | –              | 900                | –  | –                   | –            | –            | –             | –             |
| 1513   | ZINC CHLORATE   | 5.1               | –                    | II             | –                  | 1 kg                                     | E2                  | P002         | –            | IBC08         | B4<br>B21     |
| 1514   | ZINC NITRATE  | 5.1               | –                    | II             | –                  | 1 kg                                     | E2                  | P002         | –            | IBC08         | B4<br>B21     |
| 1515   | ZINC PERMANGANATE   | 5.1               | –                    | II             | –                  | 1 kg                                     | E2                  | P002         | –            | IBC06         | B21           |
| 1516   | ZINC PEROXIDE   | 5.1               | –                    | II             | –                  | 1 kg                                     | E2                  | P002         | PP100        | IBC06         | B21           |
| 1517   | ZIRCONIUM PICRAMATE, WETTED with not less than 20% water, by mass | 4.1               | –                    | I              | 28                 | 0  | E0                  | P406         | PP26<br>PP31 | –             | –             |
| 1541   | ACETONE CYANOHYDRIN, STABILIZED                                   | 6.1               | –<br>P               | I              | 354                | 0  | E0                  | P602         | –            | –             | –             |
| 1544   | ALKALOIDS, SOLID, N.O.S. or ALKALOIDS SALTS, SOLID, N.O.S.        | 6.1               | –                    | I              | 43<br>274          | 0  | E5                  | P002         | –            | IBC07         | B1            |
| 1544   | ALKALOIDS, SOLID, N.O.S. or ALKALOIDS SALTS, SOLID, N.O.S.        | 6.1               | –                    | II             | 43<br>274          | 500 g                                    | E4                  | P002         | –            | IBC08         | B4<br>B21     |
| 1544   | ALKALOIDS, SOLID, N.O.S. or ALKALOIDS SALTS, SOLID, N.O.S.        | 6.1               | –                    | III            | 43<br>223<br>274   | 5 kg                                     | E1                  | P002<br>LP02 | –            | IBC08         | B3            |

| UN No. | Portable tanks and bulk containers |               | EmS                    | Stowage and handling     | Segregation                                   | Properties and observations  | UN No. |
|--------|------------------------------------|---------------|------------------------|--------------------------|---|--|--------|
|        | Tank instructions                  | Provisions    |                        |                          |   |  |        |
| (12)   | (13)<br>4.2.5<br>4.3               | (14)<br>4.2.5 | (15)<br>5.4.3.4<br>7.8 | (16a)<br>7.1<br>7.3–7.7  | (16b)<br>7.2–7.7                              | (17)   | (18)   |
| –      | T3                                 | TP33          | F-H, S-Q               | Category A               | SGG13<br>SG38<br>SG49                         | Colourless crystals or powder, soluble in water. Reacts vigorously with sulphuric acid. Reacts fiercely with cyanides when heated or by friction. May form explosive mixtures with combustible material, powdered metals or ammonium compounds. These mixtures are sensitive to friction and are liable to ignite. When involved in a fire, may cause an explosion.                                  | 1508   |
| –      | T3                                 | TP33          | F-G, S-Q               | Category C<br>H1         | SGG16<br>SG16<br>SG26<br>SG35<br>SG59         | Colourless powder. Particularly if wetted with small quantities of water, a mixture with combustible materials may ignite following impact or friction. When involved in a fire, or in contact with water or acids, decomposes, evolving oxygen.   | 1509   |
| –      | –                                  | –             | F-H, S-Q               | Category D<br>SW2        | SG16  | Colourless liquid with a pungent odour. Freezing point: 12.5°C. Insoluble in water. Mixtures with combustible material are readily ignited, burn fiercely and may also explode by friction or shock. Highly toxic if swallowed, by skin contact or by inhalation.  | 1510   |
| –      | T1                                 | TP33          | F-A, S-Q               | Category A<br>H1         | –   | White crystals or powder. Soluble in water. Mixtures with combustible material are sensitive to friction and are liable to ignite. Irritating to skin, eyes and mucous membranes.  | 1511   |
| –      | –                                  | –             | –                      | –                        | –   | Transport is prohibited.   | 1512   |
| –      | T3                                 | TP33          | F-H, S-Q               | Category A               | SGG4<br>SGG7<br>SG38<br>SG49                  | Colourless or yellowish crystals. Soluble in water. Reacts vigorously with sulphuric acid. Reacts fiercely with cyanides when heated or by friction. May form explosive mixtures with combustible material, powdered metals or ammonium compounds. These mixtures are sensitive to friction and are liable to ignite. When involved in a fire, may cause an explosion.                               | 1513   |
| –      | T3                                 | TP33          | F-H, S-Q               | Category A               | SGG7  | Colourless solid. Soluble in water. Melting point: 36°C. Mixtures with combustible material are readily ignited and may burn fiercely. Solutions in water are slightly corrosive. Harmful if swallowed.  | 1514   |
| –      | T3                                 | TP33          | F-H, S-Q               | Category D               | SGG7<br>SGG14<br>SG38<br>SG49<br>SG60         | Violet-brown or black crystals or powder. Soluble in water. Reacts vigorously with sulphuric acid and hydrogen peroxide. Reacts fiercely with cyanides when heated or by friction. May form explosive mixtures with combustible material, powdered metals or ammonium compounds. These mixtures are sensitive to friction and are liable to ignite. When involved in a fire, may cause an explosion. | 1515   |
| –      | T3                                 | TP33          | F-G, S-Q               | Category C<br>H1         | SGG7<br>SGG16<br>SG16<br>SG26<br>SG35<br>SG59 | White powder. Particularly if wetted with small quantities of water, a mixture with combustible material may ignite following impact or friction. When involved in a fire, or in contact with water or acids, decomposes, evolving oxygen.   | 1516   |
| –      | –                                  | –             | F-B, S-J               | Category D               | SG7<br>SG30                                   | Desensitized explosive. Highly explosive in the dry state or if insufficiently wetted. May react violently in contact with heavy metals or their salts.  | 1517   |
| –      | T20                                | TP2<br>TP13   | F-A, S-A               | Category D<br>SW1<br>SW2 | SGG6<br>SG35<br>SG36                          | Colourless to amber liquid evolving toxic vapour. Miscible with water. Unstable in contact with acids and alkalis, evolving hydrogen cyanide, a highly toxic and flammable gas. Highly toxic if swallowed, by skin contact or by inhalation.   | 1541   |
| –      | T6                                 | TP33          | F-A, S-A               | Category A               | –   | A wide range of toxic solids, generally of vegetable origin. Toxic if swallowed, by skin contact or by inhalation.   | 1544   |
| –      | T3                                 | TP33          | F-A, S-A               | Category A               | –   | See entry above.   | 1544   |
| –      | T1                                 | TP33          | F-A, S-A               | Category A               | –   | See entry above.   | 1544   |

Part 3 – Dangerous Goods List, special provisions and exceptions

Chapter 3.2 – Dangerous Goods List

| UN No. | Proper shipping name (PSN)   | Class or division | Subsidiary hazard(s) | Packing group  | Special provisions | Limited and excepted quantity provisions |                     | Packing      |              | IBC           |               |
|--------|--|-------------------|----------------------|----------------|--------------------|--|---------------------|--------------|--------------|---------------|---------------|
|        |  |                   |                      |                |                    | Limited quantities                       | Excepted quantities | Instructions | Provisions   | Instructions  | Provisions    |
| (1)    | (2)<br>3.1.2   | (3)<br>2.0        | (4)<br>2.0           | (5)<br>2.0.1.3 | (6)<br>3.3         | (7a)<br>3.4                              | (7b)<br>3.5         | (8)<br>4.1.4 | (9)<br>4.1.4 | (10)<br>4.1.4 | (11)<br>4.1.4 |
| 1545   | ALLYL ISOTHIOCYANATE, STABILIZED   | 6.1               | 3                    | II             | 386                | 100 mL                                   | E0                  | P001         | –            | IBC02         | –             |
| 1546   | AMMONIUM ARSENATE  | 6.1               | –                    | II             | –                  | 500 g                                    | E4                  | P002         | –            | IBC08         | B4<br>B21     |
| 1547   | ANILINE  | 6.1               | –<br>P               | II             | 279                | 100 mL                                   | E4                  | P001         | –            | IBC02         | –             |
| 1548   | ANILINE HYDROCHLORIDE  | 6.1               | –                    | III            | –                  | 5 kg                                     | E1                  | P002<br>LP02 | –            | IBC08         | B3            |
| 1549   | ANTIMONY COMPOUND, INORGANIC, SOLID, N.O.S.  | 6.1               | –                    | III            | 45<br>274          | 5 kg                                     | E1                  | P002<br>LP02 | –            | IBC08         | B3            |
| 1550   | ANTIMONY LACTATE   | 6.1               | –                    | III            | –                  | 5 kg                                     | E1                  | P002<br>LP02 | –            | IBC08         | B3            |
| 1551   | ANTIMONY POTASSIUM TARTRATE  | 6.1               | –                    | III            | –                  | 5 kg                                     | E1                  | P002<br>LP02 | –            | IBC08         | B3            |
| 1553   | ARSENIC ACID, LIQUID   | 6.1               | –                    | I              | –                  | 0  | E5                  | P001         | PP31         | –             | –             |
| 1554   | ARSENIC ACID, SOLID  | 6.1               | –                    | II             | –                  | 500 g                                    | E4                  | P002         | –            | IBC08         | B4<br>B21     |
| 1555   | ARSENIC BROMIDE  | 6.1               | –                    | II             | –                  | 500 g                                    | E4                  | P002         | –            | IBC08         | B4<br>B21     |
| 1556   | ARSENIC COMPOUND, LIQUID, N.O.S. inorganic, including: Arsenates, n.o.s., Arsenites, n.o.s., and Arsenic sulphides, n.o.s. | 6.1               | –                    | I              | 43<br>274          | 0  | E5                  | P001         | –            | –             | –             |
| 1556   | ARSENIC COMPOUND, LIQUID, N.O.S. inorganic, including: Arsenates, n.o.s., Arsenites, n.o.s., and Arsenic sulphides, n.o.s. | 6.1               | –                    | II             | 43<br>274          | 100 mL                                   | E4                  | P001         | –            | IBC02         | –             |
| 1556   | ARSENIC COMPOUND, LIQUID, N.O.S. inorganic, including: Arsenates, n.o.s., Arsenites, n.o.s., and Arsenic sulphides, n.o.s. | 6.1               | –                    | III            | 43<br>223<br>274   | 5 L                                      | E1                  | P001<br>LP01 | –            | IBC03         | –             |
| 1557   | ARSENIC COMPOUND, SOLID, N.O.S. inorganic, including: Arsenates, n.o.s.; Arsenites, n.o.s.; and Arsenic sulphides, n.o.s.  | 6.1               | –                    | I              | 43<br>274          | 0  | E5                  | P002         | –            | IBC07         | B1            |
| 1557   | ARSENIC COMPOUND, SOLID, N.O.S. inorganic, including: Arsenates, n.o.s.; Arsenites, n.o.s.; and Arsenic sulphides, n.o.s.  | 6.1               | –                    | II             | 43<br>274          | 500 g                                    | E4                  | P002         | –            | IBC08         | B4<br>B21     |
| 1557   | ARSENIC COMPOUND, SOLID, N.O.S. inorganic, including: Arsenates, n.o.s.; Arsenites, n.o.s.; and Arsenic sulphides, n.o.s.  | 6.1               | –                    | III            | 43<br>223<br>274   | 5 kg                                     | E1                  | P002<br>LP02 | –            | IBC08         | B3            |

| UN No. | Portable tanks and bulk containers |                     | EmS                    | Stowage and handling           | Segregation      | Properties and observations   | UN No. |
|--------|------------------------------------|---------------------|------------------------|--------------------------------|------------------|---|--------|
|        | Tank instructions                  | Provisions          |                        |                                |                  |   |        |
| (12)   | (13)<br>4.2.5<br>4.3               | (14)<br>4.2.5       | (15)<br>5.4.3.4<br>7.8 | (16a)<br>7.1<br>7.3–7.7        | (16b)<br>7.2–7.7 | (17)  | (18)   |
| –      | T7                                 | TP2                 | F-E, S-D               | Category D<br>SW1<br>SW2       | –                | Colourless liquid evolving toxic vapour which is irritating and causes tears. Flashpoint: 46°C c.c. Toxic if swallowed, by skin contact or by inhalation.   | 1545   |
| –      | T3                                 | TP33                | F-A, S-A               | Category A                     | SGG2<br>SG36     | White powder or crystals. Soluble in water. Reacts with alkalis, evolving ammonia gas. Toxic if swallowed, by skin contact or by dust inhalation.   | 1546   |
| –      | T7                                 | TP2                 | F-A, S-A               | Category A<br>SW2              | SG35             | Colourless, oily, volatile liquid. Reacts with acids. Toxic if swallowed, by skin contact or by inhalation.   | 1547   |
| –      | T1                                 | TP33                | F-A, S-A               | Category A                     | –                | White, crystalline solid. Soluble in water. Decomposes to aniline in contact with alkalis. Toxic if swallowed, by skin contact or by inhalation.  | 1548   |
| –      | T1                                 | TP33                | F-A, S-A               | Category A                     | –                | A wide range of toxic solids. Toxic if swallowed, by skin contact or by inhalation.   | 1549   |
| –      | T1                                 | TP33                | F-A, S-A               | Category A                     | –                | White powder or crystals. Toxic if swallowed, by skin contact or by dust inhalation.  | 1550   |
| –      | T1                                 | TP33                | F-A, S-A               | Category A                     | –                | Colourless crystals or white powder. Toxic if swallowed, by skin contact or by dust inhalation.   | 1551   |
| –      | T20                                | TP2<br>TP7<br>TP13  | F-A, S-A               | Category B                     | SG33             | White, deliquescent crystals which readily become liquid. Melting point: approximately 35°C. Miscible with water. In contact with metals, may evolve arsine, an extremely toxic gas. Highly toxic if swallowed, by skin contact or by inhalation. | 1553   |
| –      | T3                                 | TP33                | F-A, S-A               | Category A                     | –                | White crystals with a relatively high melting point. Soluble in water. Toxic if swallowed, by skin contact or by dust inhalation.   | 1554   |
| –      | T3                                 | TP33                | F-A, S-A               | Category A<br>SW1<br>SW2<br>H2 | –                | White, deliquescent crystals. Melting point: approximately 33°C. Decomposed by water, evolving hydrogen bromide, an irritating and corrosive gas, apparent as white fumes. Toxic if swallowed, by skin contact or by dust inhalation.             | 1555   |
| –      | T14                                | TP2<br>TP13<br>TP27 | F-A, S-A               | Category B<br>SW2              | SG70             | A wide variety of toxic liquids. In contact with acids, arsenic sulphide evolves hydrogen sulphide, a toxic and flammable gas. Toxic if swallowed, by skin contact or by inhalation.  | 1556   |
| –      | T11                                | TP2<br>TP13<br>TP27 | F-A, S-A               | Category B<br>SW2              | SG70             | See entry above.  | 1556   |
| –      | T7                                 | TP2<br>TP28         | F-A, S-A               | Category B<br>SW2              | SG70             | See entry above.  | 1556   |
| –      | T6                                 | TP33                | F-A, S-A               | Category A                     | SG70             | A wide variety of toxic solids. In contact with acids, arsenic sulphide evolves hydrogen sulphide, a toxic and flammable gas. Toxic if swallowed, by skin contact or by dust inhalation.  | 1557   |
| –      | T3                                 | TP33                | F-A, S-A               | Category A                     | SG70             | See entry above.  | 1557   |
| –      | T1                                 | TP33                | F-A, S-A               | Category A                     | SG70             | See entry above.  | 1557   |



Part 3 – Dangerous Goods List, special provisions and exceptions

Chapter 3.2 – Dangerous Goods List

| UN No. | Proper shipping name (PSN)                                 | Class or division | Subsidiary hazard(s) | Packing group  | Special provisions | Limited and excepted quantity provisions |                     | Packing      |              | IBC           |               |
|--------|--|-------------------|----------------------|----------------|--------------------|--|---------------------|--------------|--------------|---------------|---------------|
|        |  |                   |                      |                |                    | Limited quantities                       | Excepted quantities | Instructions | Provisions   | Instructions  | Provisions    |
| (1)    | (2)<br>3.1.2   | (3)<br>2.0        | (4)<br>2.0           | (5)<br>2.0.1.3 | (6)<br>3.3         | (7a)<br>3.4                              | (7b)<br>3.5         | (8)<br>4.1.4 | (9)<br>4.1.4 | (10)<br>4.1.4 | (11)<br>4.1.4 |
| 1558   | ARSENIC  | 6.1               | –                    | II             | –                  | 500 g                                    | E4                  | P002         | –            | IBC08         | B4<br>B21     |
| 1559   | ARSENIC PENTOXIDE  | 6.1               | –                    | II             | –                  | 500 g                                    | E4                  | P002         | –            | IBC08         | B4<br>B21     |
| 1560   | ARSENIC TRICHLORIDE  | 6.1               | –                    | I              | –                  | 0  | E0                  | P602         | –            | –             | –             |
| 1561   | ARSENIC TRIOXIDE   | 6.1               | –                    | II             | –                  | 500 g                                    | E4                  | P002         | –            | IBC08         | B4<br>B21     |
| 1562   | ARSENICAL DUST   | 6.1               | –                    | II             | –                  | 500 g                                    | E4                  | P002         | –            | IBC08         | B4<br>B21     |
| 1564   | BARIUM COMPOUND, N.O.S.                                    | 6.1               | –                    | II             | 177<br>274         | 500 g                                    | E4                  | P002         | –            | IBC08         | B4<br>B21     |
| 1564   | BARIUM COMPOUND, N.O.S.                                    | 6.1               | –                    | III            | 177<br>223<br>274  | 5 kg                                     | E1                  | P002<br>LP02 | –            | IBC08         | B3            |
| 1565   | BARIUM CYANIDE   | 6.1               | –<br>P               | I              | –                  | 0  | E5                  | P002         | PP31         | IBC07         | B1            |
| 1566   | BERYLLIUM COMPOUND, N.O.S.                                 | 6.1               | –                    | II             | 274                | 500 g                                    | E4                  | P002         | –            | IBC08         | B4<br>B21     |
| 1566   | BERYLLIUM COMPOUND, N.O.S.                                 | 6.1               | –                    | III            | 223<br>274         | 5 kg                                     | E1                  | P002<br>LP02 | –            | IBC08         | B3            |
| 1567   | BERYLLIUM POWDER   | 6.1               | 4.1                  | II             | –                  | 500 g                                    | E4                  | P002         | PP100        | IBC08         | B4<br>B21     |
| 1569   | BROMOACETONE   | 6.1               | 3<br>P               | II             | –                  | 0  | E0                  | P602         | –            | –             | –             |
| 1570   | BRUCINE  | 6.1               | –                    | I              | 43                 | 0  | E5                  | P002         | –            | IBC07         | B1            |
| 1571   | BARIUM AZIDE, WETTED with not less than 50% water, by mass | 4.1               | 6.1                  | I              | 28                 | 0  | E0                  | P406         | PP31         | –             | –             |
| 1572   | CACODYLIC ACID   | 6.1               | –                    | II             | –                  | 500 g                                    | E4                  | P002         | –            | IBC08         | B4<br>B21     |
| 1573   | CALCIUM ARSENATE   | 6.1               | –<br>P               | II             | –                  | 500 g                                    | E4                  | P002         | –            | IBC08         | B4<br>B21     |
| 1574   | CALCIUM ARSENATE AND CALCIUM ARSENITE MIXTURE, SOLID       | 6.1               | –<br>P               | II             | –                  | 500 g                                    | E4                  | P002         | –            | IBC08         | B4<br>B21     |
| 1575   | CALCIUM CYANIDE  | 6.1               | –<br>P               | I              | –                  | 0  | E5                  | P002         | PP31         | IBC07         | B1            |
| 1577   | CHLORODINITROBENZENES, LIQUID                              | 6.1               | –<br>P               | II             | 279                | 100 mL                                   | E4                  | P001         | –            | IBC02         | –             |
| 1578   | CHLORONITROBENZENES, SOLID                                 | 6.1               | –                    | II             | 279                | 500 g                                    | E4                  | P002         | –            | IBC08         | B4<br>B21     |
| 1579   | 4-CHLORO- <i>o</i> -TOLUIDINE HYDROCHLORIDE, SOLID         | 6.1               | –                    | III            | –                  | 5 kg                                     | E1                  | P002<br>LP02 | –            | IBC08         | B3            |

| UN No. | Portable tanks and bulk containers |               | EmS                    | Stowage and handling    | Segregation                  | Properties and observations  | UN No. |
|--------|------------------------------------|---------------|------------------------|-------------------------|------------------------------|--|--------|
|        | Tank instructions                  | Provisions    |                        |                         |                              |  |        |
| (12)   | (13)<br>4.2.5<br>4.3               | (14)<br>4.2.5 | (15)<br>5.4.3.4<br>7.8 | (16a)<br>7.1<br>7.3–7.7 | (16b)<br>7.2–7.7             | (17)   | (18)   |
| –      | T3                                 | TP33          | F-A, S-A               | Category A              | –                            | Silvery, brittle, crystalline solid with the appearance of a metal. Toxic if swallowed, by skin contact or by dust inhalation.   | 1558   |
| –      | T3                                 | TP33          | F-A, S-A               | Category A              | –                            | White, deliquescent powder. Soluble in water. Toxic if swallowed, by skin contact or by dust inhalation.   | 1559   |
| –      | T14                                | TP2<br>TP13   | F-A, S-A               | Category B<br>SW2       | –                            | Colourless, oily liquid. Fumes in moist air, evolving hydrogen chloride, an irritating and corrosive gas, apparent as white fumes. Reacts with water. Highly toxic if swallowed, by skin contact or by inhalation.   | 1560   |
| –      | T3                                 | TP33          | F-A, S-A               | Category A              | –                            | White powder. Slightly soluble in water. Toxic if swallowed, by skin contact or by dust inhalation.  | 1561   |
| –      | T3                                 | TP33          | F-A, S-A               | Category A              | –                            | Fine powder. Toxic if swallowed, by skin contact or by dust inhalation.  | 1562   |
| –      | T3                                 | TP33          | F-A, S-A               | Category A              | –                            | White powder, lumps or crystals. Toxic if swallowed, by skin contact or by inhalation.   | 1564   |
| –      | T1                                 | TP33          | F-A, S-A               | Category A              | –                            | See entry above.   | 1564   |
| –      | T6                                 | TP33          | F-A, S-A               | Category A<br>SW2       | SGG6<br>SG35                 | White crystals or powder. Soluble in water. Reacts with acids or acid fumes, evolving hydrogen cyanide, a highly toxic and flammable gas. Highly toxic if swallowed, by skin contact or by dust inhalation.  | 1565   |
| –      | T3                                 | TP33          | F-A, S-A               | Category A              | –                            | A wide range of toxic solids. Toxic if swallowed, by skin contact or by dust inhalation.   | 1566   |
| –      | T1                                 | TP33          | F-A, S-A               | Category A              | –                            | See entry above.   | 1566   |
| –      | T3                                 | TP33          | F-G, S-G               | Category A<br>H1        | SG25<br>SG26                 | White, metallic powder. Toxic if swallowed, by skin contact or by dust inhalation.   | 1567   |
| –      | T20                                | TP2<br>TP13   | F-E, S-D               | Category D<br>SW2       | –                            | When pure, colourless liquid evolving irritating vapour (“Tear Gas”). Flashpoint: approximately 45°C c.c. Toxic if swallowed, by skin contact or by inhalation.  | 1569   |
| –      | T6                                 | TP33          | F-A, S-A               | Category A              | –                            | White crystals or powder. Highly toxic if swallowed, by skin contact or by dust inhalation.  | 1570   |
| –      | –                                  | –             | F-B, S-J               | Category D              | SGG17<br>SG7<br>SG30         | Desensitized explosive. White crystals or powder. Explosive and sensitive to friction in the dry state. Toxic if swallowed, by skin contact or by dust inhalation. May form extremely sensitive compounds with heavy metals or their salts.                    | 1571   |
| –      | T3                                 | TP33          | F-A, S-A               | Category E              | SGG1<br>SG35<br>SG36<br>SG49 | Colourless crystals or white powder with an offensive odour. Soluble in water. May react with acids, evolving dimethylarsine, an extremely toxic gas. Toxic if swallowed, by skin contact or by dust inhalation.   | 1572   |
| –      | T3                                 | TP33          | F-A, S-A               | Category A              | –                            | White powder. Slightly soluble in water. Toxic if swallowed, by skin contact or by dust inhalation.  | 1573   |
| –      | T3                                 | TP33          | F-A, S-A               | Category A              | –                            | White powder. Toxic if swallowed, by skin contact or by dust inhalation.   | 1574   |
| –      | T6                                 | TP33          | F-A, S-A               | Category A<br>SW2       | SGG6<br>SG35                 | White crystals or powder. Decomposes slowly in water to form a weak hydrogen cyanide solution. Reacts with acids or acid fumes, evolving hydrogen cyanide, a highly toxic and flammable gas. Highly toxic if swallowed, by skin contact or by dust inhalation. | 1575   |
| –      | T7                                 | TP2           | F-A, S-A               | Category A              | SG15                         | Colourless liquids. May explode if involved in a fire. Toxic if swallowed, by skin contact or by inhalation.   | 1577   |
| –      | T3                                 | TP33          | F-A, S-A               | Category A              | –                            | Yellow crystals. Melting point: approximately 30°C to 80°C. Toxic if swallowed, by skin contact or by dust inhalation.   | 1578   |
| –      | T1                                 | TP33          | F-A, S-A               | Category A              | –                            | Dry solid or paste. Toxic if swallowed, by skin contact or by dust inhalation.   | 1579   |

Part 3 – Dangerous Goods List, special provisions and exceptions

Chapter 3.2 – Dangerous Goods List

| UN No. | Proper shipping name (PSN)   | Class or division | Subsidiary hazard(s) | Packing group  | Special provisions | Limited and excepted quantity provisions |                     | Packing      |              | IBC           |               |
|--------|--|-------------------|----------------------|----------------|--------------------|--|---------------------|--------------|--------------|---------------|---------------|
|        |  |                   |                      |                |                    | Limited quantities                       | Excepted quantities | Instructions | Provisions   | Instructions  | Provisions    |
| (1)    | (2)<br>3.1.2   | (3)<br>2.0        | (4)<br>2.0           | (5)<br>2.0.1.3 | (6)<br>3.3         | (7a)<br>3.4                              | (7b)<br>3.5         | (8)<br>4.1.4 | (9)<br>4.1.4 | (10)<br>4.1.4 | (11)<br>4.1.4 |
| 1580   | CHLOROPICRIN   | 6.1               | -<br>P               | I              | 354                | 0  | E0                  | P601         | -            | -             | -             |
| 1581   | CHLOROPICRIN AND METHYL BROMIDE MIXTURE with more than 2% chloropicrin | 2.3               | -                    | -              | -                  | 0  | E0                  | P200         | -            | -             | -             |
| 1582   | CHLOROPICRIN AND METHYL CHLORIDE MIXTURE                               | 2.3               | -                    | -              | -                  | 0  | E0                  | P200         | -            | -             | -             |
| 1583   | CHLOROPICRIN MIXTURE, N.O.S.   | 6.1               | -                    | I              | 43<br>274<br>315   | 0  | E0                  | P602         | -            | -             | -             |
| 1583   | CHLOROPICRIN MIXTURE, N.O.S.   | 6.1               | -                    | II             | 43<br>274          | 100 mL                                   | E0                  | P001         | -            | IBC02         | -             |
| 1583   | CHLOROPICRIN MIXTURE, N.O.S.   | 6.1               | -                    | III            | 43<br>223<br>274   | 5 L                                      | E0                  | P001<br>LP01 | -            | IBC03         | -             |
| 1585   | COPPER ACETOARSENITE   | 6.1               | -<br>P               | II             | -                  | 500 g                                    | E4                  | P002         | -            | IBC08         | B4<br>B21     |
| 1586   | COPPER ARSENITE  | 6.1               | -<br>P               | II             | -                  | 500 g                                    | E4                  | P002         | -            | IBC08         | B4<br>B21     |
| 1587   | COPPER CYANIDE   | 6.1               | -<br>P               | II             | -                  | 500 g                                    | E4                  | P002         | -            | IBC08         | B4<br>B21     |
| 1588   | CYANIDES, INORGANIC, SOLID, N.O.S.                                     | 6.1               | -<br>P               | I              | 47<br>274          | 0  | E5                  | P002         | -            | IBC07         | B1            |
| 1588   | CYANIDES, INORGANIC, SOLID, N.O.S.                                     | 6.1               | -<br>P               | II             | 47<br>274          | 500 g                                    | E4                  | P002         | -            | IBC08         | B4<br>B21     |
| 1588   | CYANIDES, INORGANIC, SOLID, N.O.S.                                     | 6.1               | -<br>P               | III            | 47<br>223<br>274   | 5 kg                                     | E1                  | P002<br>LP02 | -            | IBC08         | B3            |
| 1589   | CYANOGEN CHLORIDE, STABILIZED  | 2.3               | 8<br>P               | -              | 386                | 0  | E0                  | P200         | -            | -             | -             |
| 1590   | DICHLOROANILINES, LIQUID   | 6.1               | -<br>P               | II             | 279                | 100 mL                                   | E4                  | P001         | -            | IBC02         | -             |
| 1591   | o-DICHLOROBENZENE  | 6.1               | -                    | III            | 279                | 5 L                                      | E1                  | P001<br>LP01 | -            | IBC03         | -             |
| 1593   | DICHLOROMETHANE  | 6.1               | -                    | III            | -                  | 5 L                                      | E1                  | P001<br>LP01 | -            | IBC03         | B8            |
| 1594   | DIETHYL SULPHATE   | 6.1               | -                    | II             | -                  | 100 mL                                   | E4                  | P001         | -            | IBC02         | -             |
| 1595   | DIMETHYL SULPHATE  | 6.1               | 8                    | I              | 354                | 0  | E0                  | P602         | -            | -             | -             |

| UN No. | Portable tanks and bulk containers |               | EmS                    | Stowage and handling     | Segregation          | Properties and observations  | UN No. |
|--------|------------------------------------|---------------|------------------------|--------------------------|----------------------|--|--------|
|        | Tank instructions                  | Provisions    |                        |                          |                      |  |        |
| (12)   | (13)<br>4.2.5<br>4.3               | (14)<br>4.2.5 | (15)<br>5.4.3.4<br>7.8 | (16a)<br>7.1<br>7.3-7.7  | (16b)<br>7.2-7.7     | (17)   | (18)   |
| -      | T22                                | TP2<br>TP13   | F-A, S-A               | Category D<br>SW2        | -                    | Colourless, oily liquid. Highly toxic if swallowed, by skin contact or by inhalation.  | 1580   |
| -      | T50                                | -             | F-C, S-U               | Category D<br>SW1<br>SW2 | -                    | Extremely volatile liquid evolving highly toxic vapours. Highly toxic by skin contact or by inhalation. Causes burns to skin and eyes; vapour irritating to mucous membranes.  | 1581   |
| -      | T50                                | -             | F-C, S-U               | Category D<br>SW1<br>SW2 | -                    | Extremely volatile liquid evolving highly toxic vapours. Highly toxic by skin contact or by inhalation. Causes burns to skin and eyes; vapour irritating to mucous membranes.  | 1582   |
| -      | -                                  | -             | F-A, S-A               | Category C<br>SW2        | -                    | A wide range of liquid mixtures. May evolve highly toxic vapour. Toxic if swallowed, by skin contact or by inhalation.   | 1583   |
| -      | -                                  | -             | F-A, S-A               | Category C<br>SW2        | -                    | See entry above.   | 1583   |
| -      | -                                  | -             | F-A, S-A               | Category C<br>SW2        | -                    | See entry above.   | 1583   |
| -      | T3                                 | TP33          | F-A, S-A               | Category A               | -                    | Green powder. Insoluble in water. Toxic if swallowed, by skin contact or by dust inhalation.   | 1585   |
| -      | T3                                 | TP33          | F-A, S-A               | Category A               | -                    | Yellowish-green powder. Insoluble in water. Toxic if swallowed, by skin contact or by dust inhalation.   | 1586   |
| -      | T3                                 | TP33          | F-A, S-A               | Category A               | SGG6<br>SGG7<br>SG35 | Green powder. Slightly soluble in water. Reacts with acids or acid fumes, evolving hydrogen cyanide, a highly toxic and flammable gas. Toxic if swallowed, by skin contact or by dust inhalation.  | 1587   |
| -      | T6                                 | TP33          | F-A, S-A               | Category A               | SGG6<br>SG35         | Solids. May be soluble in water. On contact with water, may form a weak hydrogen cyanide solution. React with acids or acid fumes, evolving hydrogen cyanide, a highly toxic and flammable gas. Toxic if swallowed, by skin contact or by dust inhalation. The provisions of this Code shall not apply to complex ferricyanides and ferrocyanides.     | 1588   |
| -      | T3                                 | TP33          | F-A, S-A               | Category A               | SGG6<br>SG35         | See entry above.   | 1588   |
| -      | T1                                 | TP33          | F-A, S-A               | Category A               | SGG6<br>SG35         | See entry above.   | 1588   |
| -      | -                                  | -             | F-C, S-U               | Category D<br>SW1<br>SW2 | -                    | Liquefied, non-flammable, toxic and corrosive gas with an irritating odour. Produces severe tearing of the eyes. On contact with water, reacts violently to give off highly toxic and corrosive fumes. Much heavier than air (2.1). Boiling point: 13°C. Toxic by skin contact or by inhalation. Highly irritating to skin, eyes and mucous membranes. | 1589   |
| -      | T7                                 | TP2           | F-A, S-A               | Category A<br>SW2        | -                    | Colourless liquid with a penetrating odour. Liquid mixtures of various isomers of dichloroanilines, some of which in the pure state may be solid, with a melting point varying from 24°C to 72°C. Toxic if swallowed, by skin contact or by inhalation.  | 1590   |
| -      | T4                                 | TP1           | F-A, S-A               | Category A               | SGG10                | Volatile liquid. Melting point: approximately -17°C. Toxic if swallowed, by skin contact or by inhalation.   | 1591   |
| -      | T7                                 | TP2           | F-A, S-A               | Category A               | SGG10                | Colourless, volatile liquid with heavy vapours. Boiling point: 40°C. When involved in a fire, evolves extremely toxic fumes (phosgene). Toxic if swallowed, by skin contact or by inhalation.  | 1593   |
| -      | T7                                 | TP2           | F-A, S-A               | Category C               | -                    | Colourless, oily liquid. Readily hydrolysed by moisture to sulphuric acid, which is a corrosive liquid. Toxic if swallowed, by skin contact or by inhalation.  | 1594   |
| -      | T20                                | TP2<br>TP13   | F-A, S-B               | Category D<br>SW2        | SGG1<br>SG36<br>SG49 | Colourless, volatile liquid evolving toxic vapours. In the presence of moisture, corrosive to most metals. Highly toxic if swallowed, by skin contact or by inhalation. Causes burns to skin, eyes and mucous membranes.   | 1595   |

| UN No. | Proper shipping name (PSN)  | Class or division | Subsidiary hazard(s) | Packing group  | Special provisions | Limited and excepted quantity provisions |                     | Packing      |              | IBC           |               |
|--------|---|-------------------|----------------------|----------------|--------------------|--|---------------------|--------------|--------------|---------------|---------------|
|        |   |                   |                      |                |                    | Limited quantities                       | Excepted quantities | Instructions | Provisions   | Instructions  | Provisions    |
| (1)    | (2)<br>3.1.2  | (3)<br>2.0        | (4)<br>2.0           | (5)<br>2.0.1.3 | (6)<br>3.3         | (7a)<br>3.4                              | (7b)<br>3.5         | (8)<br>4.1.4 | (9)<br>4.1.4 | (10)<br>4.1.4 | (11)<br>4.1.4 |
| 1596   | DINITROANILINES   | 6.1               | –                    | II             | –                  | 500 g                                    | E4                  | P002         | –            | IBC08         | B4<br>B21     |
| 1597   | DINITROBENZENES, LIQUID   | 6.1               | –                    | II             | –                  | 100 mL                                   | E4                  | P001         | –            | IBC03         | –             |
| 1597   | DINITROBENZENES, LIQUID   | 6.1               | –                    | III            | 223                | 5 L                                      | E1                  | P001<br>LP01 | –            | IBC03         | –             |
| 1598   | DINITRO- <i>o</i> -CRESOL   | 6.1               | –<br>P               | II             | 43                 | 500 g                                    | E4                  | P002         | –            | IBC08         | B4<br>B21     |
| 1599   | DINITROPHENOL SOLUTION  | 6.1               | –<br>P               | II             | –                  | 100 mL                                   | E4                  | P001         | –            | IBC02         | –             |
| 1599   | DINITROPHENOL SOLUTION  | 6.1               | –<br>P               | III            | 223                | 5 L                                      | E1                  | P001<br>LP01 | –            | IBC03         | –             |
| 1600   | DINITROTOLUENES, MOLTEN   | 6.1               | –<br>P               | II             | –                  | 0  | E0                  | –            | –            | –             | –             |
| 1601   | DISINFECTANT, SOLID, TOXIC, N.O.S.                                    | 6.1               | –                    | I              | 274                | 0  | E5                  | P002         | –            | IBC07         | B1            |
| 1601   | DISINFECTANT, SOLID, TOXIC, N.O.S.                                    | 6.1               | –                    | II             | 274                | 500 g                                    | E4                  | P002         | –            | IBC08         | B4<br>B21     |
| 1601   | DISINFECTANT, SOLID, TOXIC, N.O.S.                                    | 6.1               | –                    | III            | 223<br>274         | 5 kg                                     | E1                  | P002<br>LP02 | –            | IBC08         | B3            |
| 1602   | DYE, LIQUID, TOXIC, N.O.S. or DYE INTERMEDIATE, LIQUID, TOXIC, N.O.S. | 6.1               | –                    | I              | 274                | 0  | E5                  | P001         | –            | –             | –             |
| 1602   | DYE, LIQUID, TOXIC, N.O.S. or DYE INTERMEDIATE, LIQUID, TOXIC, N.O.S. | 6.1               | –                    | II             | 274                | 100 mL                                   | E4                  | P001         | –            | IBC02         | –             |
| 1602   | DYE, LIQUID, TOXIC, N.O.S. or DYE INTERMEDIATE, LIQUID, TOXIC, N.O.S. | 6.1               | –                    | III            | 223<br>274         | 5 L                                      | E1                  | P001<br>LP01 | –            | IBC03         | –             |
| 1603   | ETHYL BROMOACETATE  | 6.1               | 3                    | II             | –                  | 100 mL                                   | E0                  | P001         | –            | IBC02         | –             |
| 1604   | ETHYLENEDIAMINE   | 8                 | 3                    | II             | –                  | 1 L                                      | E2                  | P001         | –            | IBC02         | –             |
| 1605   | ETHYLENE DIBROMIDE  | 6.1               | –                    | I              | 354                | 0  | E0                  | P602         | –            | –             | –             |
| 1606   | FERRIC ARSENATE   | 6.1               | –<br>P               | II             | –                  | 500 g                                    | E4                  | P002         | –            | IBC08         | B4<br>B21     |
| 1607   | FERRIC ARSENITE   | 6.1               | –<br>P               | II             | –                  | 500 g                                    | E4                  | P002         | –            | IBC08         | B4<br>B21     |
| 1608   | FERROUS ARSENATE  | 6.1               | –<br>P               | II             | –                  | 500 g                                    | E4                  | P002         | –            | IBC08         | B4<br>B21     |
| 1611   | HEXAETHYL TETRAPHOSPHATE  | 6.1               | –<br>P               | II             | –                  | 100 mL                                   | E4                  | P001         | –            | IBC02         | –             |
| 1612   | HEXAETHYL TETRAPHOSPHATE AND COMPRESSED GAS MIXTURE                   | 2.3               | –                    | –              | –                  | 0  | E0                  | P200         | –            | –             | –             |

| UN No. | Portable tanks and bulk containers |               | EmS                    | Stowage and handling    | Segregation      | Properties and observations  | UN No. |
|--------|------------------------------------|---------------|------------------------|-------------------------|------------------|--|--------|
|        | Tank instructions                  | Provisions    |                        |                         |                  |  |        |
| (12)   | (13)<br>4.2.5<br>4.3               | (14)<br>4.2.5 | (15)<br>5.4.3.4<br>7.8 | (16a)<br>7.1<br>7.3–7.7 | (16b)<br>7.2–7.7 | (17)   | (18)   |
| –      | T3                                 | TP33          | F-A, S-A               | Category A              | SG15             | Yellow crystals in pure form. Insoluble in water. May explode if involved in a fire. Toxic if swallowed, by skin contact or by inhalation.   | 1596   |
| –      | T7                                 | TP2           | F-A, S-A               | Category A              | SG15             | Yellow solutions. May explode if involved in a fire. Toxic if swallowed, by skin contact or by inhalation.   | 1597   |
| –      | T7                                 | TP2           | F-A, S-A               | Category A              | SG15             | See entry above.   | 1597   |
| –      | T3                                 | TP33          | F-A, <u>S-A</u>        | Category A              | –                | Yellow crystals or crystallized mass. Slightly soluble in water. Toxic if swallowed, by skin contact or by dust inhalation.  | 1598   |
| –      | T7                                 | TP2           | F-A, <u>S-A</u>        | Category A              | SG30             | Substance when pure consists of yellow crystals. Slightly soluble in water. May form extremely sensitive compounds with heavy metals or their salts. Toxic if swallowed, by skin contact or by inhalation. | 1599   |
| –      | T4                                 | TP1           | F-A, <u>S-A</u>        | Category A              | SG30             | See entry above.   | 1599   |
| –      | T7                                 | TP3           | F-A, <u>S-A</u>        | Category C              | –                | Molten liquid. This entry covers the 2,3-, 2,4-, 2,5-, 2,6-, 3,4- and 3,5-isomers having melting points between 52°C and 93°C. Toxic if swallowed, by skin contact or by inhalation.                       | 1600   |
| –      | T6                                 | TP33          | F-A, S-A               | Category A<br>SW2       | –                | A wide range of toxic solids. Toxic if swallowed, by skin contact or by inhalation.  | 1601   |
| –      | T3                                 | TP33          | F-A, S-A               | Category A<br>SW2       | –                | See entry above.   | 1601   |
| –      | T1                                 | TP33          | F-A, S-A               | Category A<br>SW2       | –                | See entry above.   | 1601   |
| –      | –                                  | –             | F-A, S-A               | Category A              | –                | A wide range of toxic liquids. Toxic if swallowed, by skin contact or by inhalation.   | 1602   |
| –      | –                                  | –             | F-A, S-A               | Category A              | –                | See entry above.   | 1602   |
| –      | –                                  | –             | F-A, S-A               | Category A              | –                | See entry above.   | 1602   |
| –      | T7                                 | TP2           | F-E, S-D               | Category D<br>SW2       | –                | Colourless, flammable liquid evolving irritating vapour ("Tear Gas"). Flashpoint: 58°C c.c. Toxic if swallowed, by skin contact or by inhalation.  | 1603   |
| –      | T7                                 | TP2           | F-E, S-C               | Category A<br>SW2       | SGG18<br>SG35    | Volatile, colourless, hygroscopic flammable liquid with an ammonia-like odour. Flashpoint: 34°C c.c. Miscible with water. Causes burns to skin, eyes and mucous membranes. Reacts violently with acids.    | 1604   |
| –      | T20                                | TP2<br>TP13   | F-A, S-A               | Category D<br>SW2       | SGG10            | Colourless, volatile liquid. Highly toxic if swallowed, by skin contact or by inhalation.  | 1605   |
| –      | T3                                 | TP33          | F-A, <u>S-A</u>        | Category A              | –                | Green crystals or powder. Insoluble in water. Toxic if swallowed, by skin contact or by dust inhalation.   | 1606   |
| –      | T3                                 | TP33          | F-A, <u>S-A</u>        | Category A              | –                | Brown or yellow powder. Insoluble in water. Toxic if swallowed, by skin contact or by dust inhalation.   | 1607   |
| –      | T3                                 | TP33          | F-A, <u>S-A</u>        | Category A              | –                | Green powder. Insoluble in water. Toxic if swallowed, by skin contact or by dust inhalation.   | 1608   |
| –      | T7                                 | TP2           | F-A, <u>S-A</u>        | Category E<br>SW2       | –                | Yellow liquid. Miscible with water. Toxic if swallowed, by skin contact or by inhalation.  | 1611   |
| –      | –                                  | –             | F-C, S-U               | Category D<br>SW2       | –                | Toxic if swallowed, by skin contact or by inhalation.  | 1612   |



| UN No. | Proper shipping name (PSN)  | Class or division | Subsidiary hazard(s) | Packing group  | Special provisions | Limited and excepted quantity provisions |                     | Packing      |              | IBC           |               |
|--------|---|-------------------|----------------------|----------------|--------------------|--|---------------------|--------------|--------------|---------------|---------------|
|        |   |                   |                      |                |                    | Limited quantities                       | Excepted quantities | Instructions | Provisions   | Instructions  | Provisions    |
| (1)    | (2)<br>3.1.2  | (3)<br>2.0        | (4)<br>2.0           | (5)<br>2.0.1.3 | (6)<br>3.3         | (7a)<br>3.4                              | (7b)<br>3.5         | (8)<br>4.1.4 | (9)<br>4.1.4 | (10)<br>4.1.4 | (11)<br>4.1.4 |
| 1613   | HYDROCYANIC ACID, AQUEOUS SOLUTION (HYDROGEN CYANIDE, AQUEOUS SOLUTION) with not more than 20% hydrogen cyanide | 6.1               | -<br>P               | I              | 900                | 0  | E0                  | P601         | -            | -             | -             |
| 1614   | HYDROGEN CYANIDE, STABILIZED, containing less than 3% water and absorbed in a porous inert material             | 6.1               | -<br>P               | I              | 386                | 0  | E0                  | P099         | -            | -             | -             |
| 1616   | LEAD ACETATE  | 6.1               | -<br>P               | III            | -                  | 5 kg                                     | E1                  | P002<br>LP02 | -            | IBC08         | B3            |
| 1617   | LEAD ARSENATES  | 6.1               | -<br>P               | II             | -                  | 500 g                                    | E4                  | P002         | -            | IBC08         | B4<br>B21     |
| 1618   | LEAD ARSENITES  | 6.1               | -<br>P               | II             | -                  | 500 g                                    | E4                  | P002         | -            | IBC08         | B4<br>B21     |
| 1620   | LEAD CYANIDE  | 6.1               | -<br>P               | II             | -                  | 500 g                                    | E4                  | P002         | -            | IBC08         | B4<br>B21     |
| 1621   | LONDON PURPLE   | 6.1               | -<br>P               | II             | 43                 | 500 g                                    | E4                  | P002         | -            | IBC08         | B4<br>B21     |
| 1622   | MAGNESIUM ARSENATE  | 6.1               | -<br>P               | II             | -                  | 500 g                                    | E4                  | P002         | -            | IBC08         | B4<br>B21     |
| 1623   | MERCURIC ARSENATE   | 6.1               | -<br>P               | II             | -                  | 500 g                                    | E4                  | P002         | -            | IBC08         | B4<br>B21     |
| 1624   | MERCURIC CHLORIDE   | 6.1               | -<br>P               | II             | -                  | 500 g                                    | E4                  | P002         | -            | IBC08         | B4<br>B21     |
| 1625   | MERCURIC NITRATE  | 6.1               | -<br>P               | II             | -                  | 500 g                                    | E4                  | P002         | -            | IBC08         | B4<br>B21     |
| 1626   | MERCURIC POTASSIUM CYANIDE  | 6.1               | -<br>P               | I              | -                  | 0  | E5                  | P002         | PP31         | IBC07         | B1            |
| 1627   | MERCUROUS NITRATE   | 6.1               | -<br>P               | II             | -                  | 500 g                                    | E4                  | P002         | -            | IBC08         | B4<br>B21     |
| 1629   | MERCURY ACETATE   | 6.1               | -<br>P               | II             | -                  | 500 g                                    | E4                  | P002         | -            | IBC08         | B4<br>B21     |
| 1630   | MERCURY AMMONIUM CHLORIDE   | 6.1               | -<br>P               | II             | -                  | 500 g                                    | E4                  | P002         | -            | IBC08         | B4<br>B21     |
| 1631   | MERCURY BENZOATE  | 6.1               | -<br>P               | II             | -                  | 500 g                                    | E4                  | P002         | -            | IBC08         | B4<br>B21     |
| 1634   | MERCURY BROMIDES  | 6.1               | -<br>P               | II             | -                  | 500 g                                    | E4                  | P002         | -            | IBC08         | B4<br>B21     |
| 1636   | MERCURY CYANIDE   | 6.1               | -<br>P               | II             | -                  | 500 g                                    | E4                  | P002         | -            | IBC08         | B4<br>B21     |
| 1637   | MERCURY GLUCONATE   | 6.1               | -<br>P               | II             | -                  | 500 g                                    | E4                  | P002         | -            | IBC08         | B4<br>B21     |
| 1638   | MERCURY IODIDE  | 6.1               | -<br>P               | II             | -                  | 500 g                                    | E4                  | P002         | -            | IBC08         | B4<br>B21     |
| 1639   | MERCURY NUCLEATE  | 6.1               | -<br>P               | II             | -                  | 500 g                                    | E4                  | P002         | -            | IBC08         | B4<br>B21     |

| UN No. | Portable tanks and bulk containers |               | EmS                    | Stowage and handling     | Segregation                   | Properties and observations  | UN No. |
|--------|------------------------------------|---------------|------------------------|--------------------------|-------------------------------|--|--------|
|        | Tank instructions                  | Provisions    |                        |                          |                               |  |        |
| (12)   | (13)<br>4.2.5<br>4.3               | (14)<br>4.2.5 | (15)<br>5.4.3.4<br>7.8 | (16a)<br>7.1<br>7.3-7.7  | (16b)<br>7.2-7.7              | (17)   | (18)   |
| -      | T14                                | TP2<br>TP13   | F-A, S-A               | Category D<br>SW2        | -                             | Colourless liquid evolving extremely toxic vapour with a bitter almond odour. Miscible with water. Highly toxic if swallowed, by skin contact or by inhalation. Transport of HYDROCYANIC ACID, AQUEOUS SOLUTION with more than 20% hydrogen cyanide and of HYDROGEN CYANIDE, AQUEOUS SOLUTION with more than 20% hydrogen cyanide is prohibited. | 1613   |
| -      | -                                  | -             | F-A, S-U               | Category D<br>SW1<br>SW2 | -                             | Very volatile, colourless liquid, evolving extremely toxic flammable vapours, absorbed in a porous inert material. Miscible with water. Highly toxic if swallowed, by skin contact or by inhalation.   | 1614   |
| -      | T1                                 | TP33          | F-A, S-A               | Category A               | SGG7<br>SGG9                  | White crystals, or brown or grey lumps. Soluble in water. Toxic if swallowed, by skin contact or by inhalation.  | 1616   |
| -      | T3                                 | TP33          | F-A, S-A               | Category A               | SGG7<br>SGG9                  | White crystals or powder. Insoluble in water. Toxic if swallowed, by skin contact or by dust inhalation.   | 1617   |
| -      | T3                                 | TP33          | F-A, S-A               | Category A               | SGG7<br>SGG9                  | White powder. Insoluble in water. Toxic if swallowed, by skin contact or by dust inhalation.   | 1618   |
| -      | T3                                 | TP33          | F-A, S-A               | Category A               | SGG6<br>SGG7<br>SGG9<br>SG35  | White powder. Slightly soluble in water. Reacts with acids or acid fumes, evolving hydrogen cyanide, a highly toxic and flammable gas. Toxic if swallowed, by skin contact or by dust inhalation.  | 1620   |
| -      | T3                                 | TP33          | F-A, S-A               | Category A               | -                             | Mixture of arsenic trioxide, lime and ferric oxide, used as an insecticide. Insoluble in water. Toxic if swallowed, by skin contact or by dust inhalation.   | 1621   |
| -      | T3                                 | TP33          | F-A, S-A               | Category A               | -                             | White crystals or powder. Insoluble in water. Toxic if swallowed, by skin contact or by dust inhalation.   | 1622   |
| -      | T3                                 | TP33          | F-A, S-A               | Category A               | SGG7<br>SGG11                 | Yellow crystals or powder. Insoluble in water. Toxic if swallowed, by skin contact or by dust inhalation.  | 1623   |
| -      | T3                                 | TP33          | F-A, S-A               | Category A               | SGG7<br>SGG11                 | White crystals or powder. Soluble in water. Toxic if swallowed, by skin contact or by dust inhalation.   | 1624   |
| -      | T3                                 | TP33          | F-A, S-A               | Category A               | SGG7<br>SGG11                 | White, deliquescent crystals or powder. Soluble in water. Toxic if swallowed, by skin contact or by dust inhalation.   | 1625   |
| -      | T6                                 | TP33          | F-A, S-A               | Category A               | SGG6<br>SGG7<br>SGG11<br>SG35 | Colourless crystals. Soluble in water. Reacts with acids, evolving hydrogen cyanide, a highly toxic and flammable gas. Highly toxic if swallowed, by skin contact or by dust inhalation.   | 1626   |
| -      | T3                                 | TP33          | F-A, S-A               | Category A               | SGG7<br>SGG11                 | Crystals or powder. Toxic if swallowed, by skin contact or by dust inhalation.   | 1627   |
| -      | T3                                 | TP33          | F-A, S-A               | Category A               | SGG7<br>SGG11                 | White crystals or powder. Toxic if swallowed, by skin contact or by dust inhalation.   | 1629   |
| -      | T3                                 | TP33          | F-A, S-A               | Category A               | SGG2<br>SGG7<br>SGG11         | White crystals or powder. Insoluble in water. Toxic if swallowed, by skin contact or by dust inhalation.   | 1630   |
| -      | T3                                 | TP33          | F-A, S-A               | Category A               | SGG7<br>SGG11                 | White crystals. Toxic if swallowed, by skin contact or by dust inhalation.   | 1631   |
| -      | T3                                 | TP33          | F-A, S-A               | Category A               | SGG7<br>SGG11                 | White crystals or powder. Toxic if swallowed, by skin contact or by dust inhalation.   | 1634   |
| -      | T3                                 | TP33          | F-A, S-A               | Category A               | SGG6<br>SGG7<br>SGG11<br>SG35 | White crystals or powder. Soluble in water. Reacts with acids or acid fumes, evolving hydrogen cyanide, a highly toxic and flammable gas. Toxic if swallowed, by skin contact or by dust inhalation.   | 1636   |
| -      | T3                                 | TP33          | F-A, S-A               | Category A               | SGG7<br>SGG11                 | Solid. Soluble in water. Toxic if swallowed, by skin contact or by dust inhalation.  | 1637   |
| -      | T3                                 | TP33          | F-A, S-A               | Category A               | SGG7<br>SGG11                 | Red crystals or powder. Insoluble in water. Toxic if swallowed, by skin contact or by dust inhalation.   | 1638   |
| -      | T3                                 | TP33          | F-A, S-A               | Category A               | SGG7<br>SGG11                 | Brown powder containing about 20% mercury. Toxic if swallowed, by skin contact or by dust inhalation.  | 1639   |

Part 3 – Dangerous Goods List, special provisions and exceptions

Chapter 3.2 – Dangerous Goods List

| UN No. | Proper shipping name (PSN)  | Class or division | Subsidiary hazard(s) | Packing group  | Special provisions | Limited and excepted quantity provisions |                     | Packing      |              | IBC           |               |
|--------|---|-------------------|----------------------|----------------|--------------------|--|---------------------|--------------|--------------|---------------|---------------|
|        |   |                   |                      |                |                    | Limited quantities                       | Excepted quantities | Instructions | Provisions   | Instructions  | Provisions    |
| (1)    | (2)<br>3.1.2  | (3)<br>2.0        | (4)<br>2.0           | (5)<br>2.0.1.3 | (6)<br>3.3         | (7a)<br>3.4                              | (7b)<br>3.5         | (8)<br>4.1.4 | (9)<br>4.1.4 | (10)<br>4.1.4 | (11)<br>4.1.4 |
| 1640   | MERCURY OLEATE  | 6.1               | -<br>P               | II             | -                  | 500 g                                    | E4                  | P002         | -            | IBC08         | B4<br>B21     |
| 1641   | MERCURY OXIDE   | 6.1               | -<br>P               | II             | -                  | 500 g                                    | E4                  | P002         | -            | IBC08         | B4<br>B21     |
| 1642   | MERCURY OXYCYANIDE, DESENSITIZED  | 6.1               | -<br>P               | II             | 900                | 500 g                                    | E4                  | P002         | -            | IBC08         | B4<br>B21     |
| 1643   | MERCURY POTASSIUM IODIDE  | 6.1               | -<br>P               | II             | -                  | 500 g                                    | E4                  | P002         | -            | IBC08         | B4<br>B21     |
| 1644   | MERCURY SALICYLATE  | 6.1               | -<br>P               | II             | -                  | 500 g                                    | E4                  | P002         | -            | IBC08         | B4<br>B21     |
| 1645   | MERCURY SULPHATE  | 6.1               | -<br>P               | II             | -                  | 500 g                                    | E4                  | P002         | -            | IBC08         | B4<br>B21     |
| 1646   | MERCURY THIOCYANATE   | 6.1               | -<br>P               | II             | -                  | 500 g                                    | E4                  | P002         | -            | IBC08         | B4<br>B21     |
| 1647   | METHYL BROMIDE AND ETHYLENE DIBROMIDE MIXTURE, LIQUID                   | 6.1               | -<br>P               | I              | 354                | 0  | E0                  | P602         | -            | -             | -             |
| 1648   | ACETONITRILE  | 3                 | -                    | II             | -                  | 1 L                                      | E2                  | P001         | -            | IBC02         | -             |
| 1649   | MOTOR FUEL ANTI-KNOCK MIXTURE   | 6.1               | -<br>P               | I              | -                  | 0  | E0                  | P602         | -            | -             | -             |
| 1650   | beta-NAPHTHYLAMINE, SOLID   | 6.1               | -                    | II             | -                  | 500 g                                    | E4                  | P002         | -            | IBC08         | B4<br>B21     |
| 1651   | NAPHTHYLTHIOUREA  | 6.1               | -                    | II             | 43                 | 500 g                                    | E4                  | P002         | -            | IBC08         | B4<br>B21     |
| 1652   | NAPHTHYLUREA  | 6.1               | -                    | II             | -                  | 500 g                                    | E4                  | P002         | -            | IBC08         | B4<br>B21     |
| 1653   | NICKEL CYANIDE  | 6.1               | -<br>P               | II             | -                  | 500 g                                    | E4                  | P002         | -            | IBC08         | B4<br>B21     |
| 1654   | NICOTINE  | 6.1               | -                    | II             | -                  | 100 mL                                   | E4                  | P001         | -            | IBC02         | -             |
| 1655   | NICOTINE COMPOUND, SOLID, N.O.S. or NICOTINE PREPARATION, SOLID, N.O.S. | 6.1               | -                    | I              | 43<br>274          | 0  | E5                  | P002         | -            | IBC07         | B1            |
| 1655   | NICOTINE COMPOUND, SOLID, N.O.S. or NICOTINE PREPARATION, SOLID, N.O.S. | 6.1               | -                    | II             | 43<br>274          | 500 g                                    | E4                  | P002         | -            | IBC08         | B4<br>B21     |
| 1655   | NICOTINE COMPOUND, SOLID, N.O.S. or NICOTINE PREPARATION, SOLID, N.O.S. | 6.1               | -                    | III            | 43<br>223<br>274   | 5 kg                                     | E1                  | P002<br>LP02 | -            | IBC08         | B3            |
| 1656   | NICOTINE HYDROCHLORIDE, LIQUID or SOLUTION                              | 6.1               | -                    | II             | 43                 | 100 mL                                   | E4                  | P001         | -            | IBC02         | -             |
| 1656   | NICOTINE HYDROCHLORIDE, LIQUID or SOLUTION                              | 6.1               | -                    | III            | 43<br>223          | 5 L                                      | E1                  | P001<br>LP01 | -            | IBC03         | -             |

| UN No. | Portable tanks and bulk containers |               | EmS                    | Stowage and handling     | Segregation                           | Properties and observations   | UN No. |
|--------|------------------------------------|---------------|------------------------|--------------------------|---------------------------------------|---|--------|
|        | Tank instructions                  | Provisions    |                        |                          |                                       |   |        |
| (12)   | (13)<br>4.2.5<br>4.3               | (14)<br>4.2.5 | (15)<br>5.4.3.4<br>7.8 | (16a)<br>7.1<br>7.3-7.7  | (16b)<br>7.2-7.7                      | (17)  | (18)   |
| -      | T3                                 | TP33          | F-A, S-A               | Category A               | SGG7<br>SGG11                         | Yellow oily paste. Insoluble in water. Toxic if swallowed, by skin contact or by inhalation.  | 1640   |
| -      | T3                                 | TP33          | F-A, S-A               | Category A               | SGG7<br>SGG11                         | Orange powder. Insoluble in water. Toxic if swallowed, by skin contact or by dust inhalation.   | 1641   |
| -      | T3                                 | TP33          | F-A, S-A               | Category A               | SGG6<br>SGG7<br>SGG11<br>SG15<br>SG35 | White crystals or powder. Reacts with acids or acid fumes, evolving hydrogen cyanide, a highly toxic and flammable gas. May explode if involved in a fire. Toxic if swallowed, by skin contact or by dust inhalation. Should be sufficiently phlegmatized (mercury oxycyanide-mercury cyanide mixtures containing not less than 65% by mass of mercury cyanide can be regarded as adequately phlegmatized). Transport of MERCURY OXYCYANIDE pure is prohibited. | 1642   |
| -      | T3                                 | TP33          | F-A, S-A               | Category A               | SGG7<br>SGG11                         | Yellow, deliquescent crystals or powder. Soluble in water. Toxic if swallowed, by skin contact or by dust inhalation.   | 1643   |
| -      | T3                                 | TP33          | F-A, S-A               | Category A               | SGG7<br>SGG11                         | White powder. Insoluble in water. Toxic if swallowed, by skin contact or by dust inhalation.  | 1644   |
| -      | T3                                 | TP33          | F-A, S-A               | Category A               | SGG7<br>SGG11                         | White crystals or powder. Decomposes in water, forming sulphuric acid. Toxic if swallowed, by skin contact or by dust inhalation.   | 1645   |
| -      | T3                                 | TP33          | F-A, S-A               | Category A               | SGG7<br>SGG11                         | White powder. Insoluble in water. Toxic if swallowed, by skin contact or by dust inhalation.  | 1646   |
| -      | T20                                | TP2<br>TP13   | F-A, S-A               | Category D<br>SW2        | SGG10                                 | Solutions of methyl bromide gas, evolving toxic vapour. Methyl bromide has a boiling point of approximately 4°C. Highly toxic if swallowed, by skin contact or by inhalation.   | 1647   |
| -      | T7                                 | TP2           | F-E, S-D               | Category B<br>SW2        | -                                     | Colourless, volatile liquid. Flashpoint: 2°C c.c. Explosive limits: 3% to 16%. Miscible with water. When involved in a fire, evolves toxic cyanide fumes. Harmful if swallowed, by skin contact or by inhalation.   | 1648   |
| -      | T14                                | TP2<br>TP13   | F-A, S-A               | Category D<br>SW1<br>SW2 | SGG7<br>SGG9                          | Volatile liquids evolving toxic vapour. Mixture of tetraethyllead or tetramethyllead with ethylene dibromide and ethylene dichloride. Insoluble in water. Highly toxic if swallowed, by skin contact or by inhalation.  | 1649   |
| -      | T3                                 | TP33          | F-A, S-A               | Category A               | -                                     | White crystals. Toxic if swallowed, by skin contact or by inhalation.   | 1650   |
| -      | T3                                 | TP33          | F-A, S-A               | Category A               | -                                     | White crystals or powder. Toxic if swallowed, by skin contact or by dust inhalation.  | 1651   |
| -      | T3                                 | TP33          | F-A, S-A               | Category A               | -                                     | Crystals or powder. Toxic if swallowed, by skin contact or by dust inhalation.  | 1652   |
| -      | T3                                 | TP33          | F-A, S-A               | Category A               | SGG6<br>SGG7<br>SG35                  | Green crystals or powder. Insoluble in water. Reacts with acids or acid fumes, evolving hydrogen cyanide, a highly toxic and flammable gas. Toxic if swallowed, by skin contact or by dust inhalation.  | 1653   |
| -      | -                                  | -             | F-A, S-A               | Category A               | -                                     | Thick colourless oil, turning brown on exposure to air. Miscible with water. Toxic if swallowed, by skin contact or by inhalation.  | 1654   |
| -      | T6                                 | TP33          | F-A, S-A               | Category B               | -                                     | A wide variety of toxic solids. Toxic if swallowed, by skin contact or by dust inhalation.  | 1655   |
| -      | T3                                 | TP33          | F-A, S-A               | Category A               | -                                     | See entry above.  | 1655   |
| -      | T1                                 | TP33          | F-A, S-A               | Category A               | -                                     | See entry above.  | 1655   |
| -      | -                                  | -             | F-A, S-A               | Category A               | -                                     | Miscible with water. Toxic if swallowed, by skin contact or by inhalation.  | 1656   |
| -      | -                                  | -             | F-A, S-A               | Category A               | -                                     | See entry above.  | 1656   |

Part 3 – Dangerous Goods List, special provisions and exceptions

Chapter 3.2 – Dangerous Goods List

| UN No. | Proper shipping name (PSN)     | Class or division | Subsidiary hazard(s) | Packing group  | Special provisions | Limited and excepted quantity provisions |                     | Packing      |              | IBC           |               |
|--------|--------------------------------|-------------------|----------------------|----------------|--------------------|--|---------------------|--------------|--------------|---------------|---------------|
|        |                                |                   |                      |                |                    | Limited quantities                       | Excepted quantities | Instructions | Provisions   | Instructions  | Provisions    |
| (1)    | (2)<br>3.1.2                   | (3)<br>2.0        | (4)<br>2.0           | (5)<br>2.0.1.3 | (6)<br>3.3         | (7a)<br>3.4                              | (7b)<br>3.5         | (8)<br>4.1.4 | (9)<br>4.1.4 | (10)<br>4.1.4 | (11)<br>4.1.4 |
| 1657   | NICOTINE SALICYLATE            | 6.1               | –                    | II             | –                  | 500 g                                    | E4                  | P002         | –            | IBC08         | B4<br>B21     |
| 1658   | NICOTINE SULPHATE SOLUTION     | 6.1               | –                    | II             | –                  | 100 mL                                   | E4                  | P001         | –            | IBC02         | –             |
| 1658   | NICOTINE SULPHATE SOLUTION     | 6.1               | –                    | III            | 223                | 5 L                                      | E1                  | P001<br>LP01 | –            | IBC03         | –             |
| 1659   | NICOTINE TARTRATE              | 6.1               | –                    | II             | –                  | 500 g                                    | E4                  | P002         | –            | IBC08         | B4<br>B21     |
| 1660   | NITRIC OXIDE, COMPRESSED       | 2.3               | 5.1/8                | –              | –                  | 0  | E0                  | P200         | –            | –             | –             |
| 1661   | NITROANILINES (o-, m-, p-)     | 6.1               | –                    | II             | 279                | 500 g                                    | E4                  | P002         | –            | IBC08         | B4<br>B21     |
| 1662   | NITROBENZENE                   | 6.1               | –                    | II             | 279                | 100 mL                                   | E4                  | P001         | –            | IBC02         | –             |
| 1663   | NITROPHENOLS (o-, m-, p-)      | 6.1               | –                    | III            | 279                | 5 kg                                     | E1                  | P002<br>LP02 | –            | IBC08         | B3            |
| 1664   | NITROTOLUENES, LIQUID          | 6.1               | –                    | II             | –                  | 100 mL                                   | E4                  | P001         | –            | IBC02         | –             |
| 1665   | NITROXYLENES, LIQUID           | 6.1               | –                    | II             | –                  | 100 mL                                   | E4                  | P001         | –            | IBC02         | –             |
| 1669   | PENTACHLOROETHANE              | 6.1               | –<br>P               | II             | –                  | 100 mL                                   | E4                  | P001         | –            | IBC02         | –             |
| 1670   | PERCHLOROMETHYL MERCAPTAN      | 6.1               | –<br>P               | I              | 354                | 0  | E0                  | P602         | –            | –             | –             |
| 1671   | PHENOL, SOLID                  | 6.1               | –                    | II             | 279                | 500 g                                    | E4                  | P002         | –            | IBC08         | B4<br>B21     |
| 1672   | PHENYL CARBYLAMINE CHLORIDE    | 6.1               | –                    | I              | –                  | 0  | E0                  | P602         | –            | –             | –             |
| 1673   | PHENYLENEDIAMINES (o-, m-, p-) | 6.1               | –                    | III            | 279                | 5 kg                                     | E1                  | P002<br>LP02 | –            | IBC08         | B3            |
| 1674   | PHENYLMERCURIC ACETATE         | 6.1               | –<br>P               | II             | 43                 | 500 g                                    | E4                  | P002         | –            | IBC08         | B4<br>B21     |
| 1677   | POTASSIUM ARSENATE             | 6.1               | –                    | II             | –                  | 500 g                                    | E4                  | P002         | –            | IBC08         | B4<br>B21     |
| 1678   | POTASSIUM ARSENITE             | 6.1               | –                    | II             | –                  | 500 g                                    | E4                  | P002         | –            | IBC08         | B4<br>B21     |
| 1679   | POTASSIUM CUPROCYANIDE         | 6.1               | –<br>P               | II             | –                  | 500 g                                    | E4                  | P002         | –            | IBC08         | B4<br>B21     |
| 1680   | POTASSIUM CYANIDE, SOLID       | 6.1               | –<br>P               | I              | –                  | 0  | E5                  | P002         | PP31         | IBC07         | B1            |

| UN No. | Portable tanks and bulk containers |               | EmS                    | Stowage and handling    | Segregation      | Properties and observations   | UN No. |
|--------|------------------------------------|---------------|------------------------|-------------------------|------------------|---|--------|
|        | Tank instructions                  | Provisions    |                        |                         |                  |   |        |
| (12)   | (13)<br>4.2.5<br>4.3               | (14)<br>4.2.5 | (15)<br>5.4.3.4<br>7.8 | (16a)<br>7.1<br>7.3–7.7 | (16b)<br>7.2–7.7 | (17)  | (18)   |
| –      | T3                                 | TP33          | F-A, S-A               | Category A              | –                | White crystals. Soluble in water. Toxic if swallowed, by skin contact or by dust inhalation.  | 1657   |
| –      | T7                                 | TP2           | F-A, S-A               | Category A              | –                | Miscible with water. Toxic if swallowed, by skin contact or by inhalation.  | 1658   |
| –      | T7                                 | TP2           | F-A, S-A               | Category A              | –                | See entry above.  | 1658   |
| –      | T3                                 | TP33          | F-A, S-A               | Category A              | –                | White crystals. Soluble in water. Toxic if swallowed, by skin contact or by dust inhalation.  | 1659   |
| –      | –                                  | –             | F-C, S-W               | Category D<br>SW2       | SG6<br>SG19      | Non-flammable, toxic and corrosive gas. Strong oxidizing agent. On contact with air, gives off brown fumes which are toxic by inhalation, with delayed effect similar to phosgene. Heavier than air (1.04). Highly irritating to skin, eyes and mucous membranes.                             | 1660   |
| –      | T3                                 | TP33          | F-A, S-A               | Category A              | –                | Yellow crystals. Toxic if swallowed, by skin contact or by dust inhalation. <i>ortho</i> -NITROANILINES may be carried in the molten state.   | 1661   |
| –      | T7                                 | TP2           | F-A, S-A               | Category A<br>SW2       | –                | Oily liquid, evolving toxic vapour. Melting point: approximately 6°C. Toxic if swallowed, by skin contact or by inhalation.   | 1662   |
| –      | T1                                 | TP33          | F-A, S-A               | Category A              | –                | Yellow crystals. Some isomers may have a melting point as low as 44°C. Toxic if swallowed, by skin contact or by dust inhalation. May be carried in the molten state.   | 1663   |
| –      | T7                                 | TP2           | F-A, S-A               | Category A              | –                | Yellow liquids. Melting points: <i>ortho</i> -NITROTOLUENE: –4°C, <i>meta</i> -NITROTOLUENE: 15°C. Toxic if swallowed, by skin contact or by inhalation.  | 1664   |
| –      | T7                                 | TP2           | F-A, S-A               | Category A              | –                | Yellow liquids. Melting points: 2-NITRO-3-XYLENE: 14°C to 16°C, 3-NITRO-2-XYLENE: 7°C to 9°C, 4-NITRO-3-XYLENE: 2°C. Immiscible with water. Toxic if swallowed, by skin contact or by inhalation.   | 1665   |
| –      | T7                                 | TP2           | F-A, S-A               | Category A<br>SW2       | SGG10            | Colourless liquid. Toxic if swallowed, by skin contact or by inhalation.  | 1669   |
| –      | T20                                | TP2<br>TP13   | F-A, S-A               | Category D<br>SW2       | –                | Yellow, oily, volatile liquid evolving irritating vapour ("Tear Gas"). Slowly decomposes in contact with water, producing hydrochloric acid. Reacts with iron or steel, evolving carbon tetrachloride. Corrosive to most metals. Highly toxic if swallowed, by skin contact or by inhalation. | 1670   |
| –      | T3                                 | TP33          | F-A, S-A               | Category A              | –                | Colourless or white crystals or crystallized mass. Melting point: 43°C (pure product). Soluble in water. Toxic if swallowed, by skin contact or by vapour inhalation. Rapidly absorbed through the skin.  | 1671   |
| –      | T14                                | TP2<br>TP13   | F-A, S-A               | Category D<br>SW2       | –                | Pale yellow, oily liquid with an irritating unpleasant odour. Highly toxic if swallowed, by skin contact or by inhalation.  | 1672   |
| –      | T1                                 | TP33          | F-A, S-A               | Category A              | –                | White crystals or powder. Toxic if swallowed, by skin contact or by dust inhalation. May be carried in the molten state.  | 1673   |
| –      | T3                                 | TP33          | F-A, S-A               | Category A              | SGG7             | Toxic if swallowed, by skin contact or by dust inhalation.  | 1674   |
| –      | T3                                 | TP33          | F-A, S-A               | Category A              | –                | Colourless crystals or white powder. Soluble in water. Toxic if swallowed, by skin contact or by dust inhalation.   | 1677   |
| –      | T3                                 | TP33          | F-A, S-A               | Category A              | –                | White powder. Soluble in water. Toxic if swallowed, by skin contact or by dust inhalation.  | 1678   |
| –      | T3                                 | TP33          | F-A, S-A               | Category A              | SGG6<br>SG35     | White crystals or powder. Soluble in water. Reacts with acids or acid fumes, evolving hydrogen cyanide, a highly toxic and flammable gas. Toxic if swallowed, by skin contact or by dust inhalation.  | 1679   |
| –      | T6                                 | TP33          | F-A, S-A               | Category B              | SGG6<br>SG35     | White, deliquescent crystals or lumps. Soluble in water. Reacts with acids or acid fumes, evolving hydrogen cyanide, a highly toxic and flammable gas. Highly toxic if swallowed, by skin contact or by dust inhalation.  | 1680   |

Part 3 – Dangerous Goods List, special provisions and exceptions

Chapter 3.2 – Dangerous Goods List

| UN No. | Proper shipping name (PSN)         | Class or division | Subsidiary hazard(s) | Packing group  | Special provisions | Limited and excepted quantity provisions |                     | Packing      |              | IBC           |               |
|--------|------------------------------------|-------------------|----------------------|----------------|--------------------|--|---------------------|--------------|--------------|---------------|---------------|
|        |                                    |                   |                      |                |                    | Limited quantities                       | Excepted quantities | Instructions | Provisions   | Instructions  | Provisions    |
| (1)    | (2)<br>3.1.2                       | (3)<br>2.0        | (4)<br>2.0           | (5)<br>2.0.1.3 | (6)<br>3.3         | (7a)<br>3.4                              | (7b)<br>3.5         | (8)<br>4.1.4 | (9)<br>4.1.4 | (10)<br>4.1.4 | (11)<br>4.1.4 |
| 1683   | SILVER ARSENITE                    | 6.1               | -<br>P               | II             | -                  | 500 g                                    | E4                  | P002         | -            | IBC08         | B4<br>B21     |
| 1684   | SILVER CYANIDE                     | 6.1               | -<br>P               | II             | -                  | 500 g                                    | E4                  | P002         | -            | IBC08         | B4<br>B21     |
| 1685   | SODIUM ARSENATE                    | 6.1               | -                    | II             | -                  | 500 g                                    | E4                  | P002         | -            | IBC08         | B4<br>B21     |
| 1686   | SODIUM ARSENITE, AQUEOUS SOLUTION  | 6.1               | -                    | II             | 43                 | 100 mL                                   | E4                  | P001         | -            | IBC02         | -             |
| 1686   | SODIUM ARSENITE, AQUEOUS SOLUTION  | 6.1               | -                    | III            | 43<br>223          | 5 L                                      | E1                  | P001<br>LP01 | -            | IBC03         | -             |
| 1687   | SODIUM AZIDE                       | 6.1               | -                    | II             | -                  | 500 g                                    | E4                  | P002         | -            | IBC08         | B4<br>B21     |
| 1688   | SODIUM CACODYLATE                  | 6.1               | -                    | II             | -                  | 500 g                                    | E4                  | P002         | -            | IBC08         | B4<br>B21     |
| 1689   | SODIUM CYANIDE, SOLID              | 6.1               | -<br>P               | I              | -                  | 0  | E5                  | P002         | PP31         | IBC07         | B1            |
| 1690   | SODIUM FLUORIDE, SOLID             | 6.1               | -                    | III            | -                  | 5 kg                                     | E1                  | P002<br>LP02 | -            | IBC08         | B3            |
| 1691   | STRONTIUM ARSENITE                 | 6.1               | -                    | II             | -                  | 500 g                                    | E4                  | P002         | -            | IBC08         | B4<br>B21     |
| 1692   | STRYCHNINE or STRYCHNINE SALTS     | 6.1               | -<br>P               | I              | 43                 | 0  | E5                  | P002         | -            | IBC07         | B1            |
| 1693   | TEAR GAS SUBSTANCE, LIQUID, N.O.S. | 6.1               | -                    | I              | 274                | 0  | E0                  | P001         | PP31         | -             | -             |
| 1693   | TEAR GAS SUBSTANCE, LIQUID, N.O.S. | 6.1               | -                    | II             | 274                | 0  | E0                  | P001         | PP31         | IBC02         | -             |
| 1694   | BROMOBENZYL CYANIDES, LIQUID       | 6.1               | -                    | I              | 138                | 0  | E0                  | P001         | PP31         | -             | -             |
| 1695   | CHLOROACETONE, STABILIZED          | 6.1               | 3/8<br>P             | I              | 354                | 0  | E0                  | P602         | -            | -             | -             |
| 1697   | CHLOROACETOPHENONE, SOLID          | 6.1               | -                    | II             | -                  | 0  | E0                  | P002         | -            | IBC08         | B4<br>B21     |
| 1698   | DIPHENYLAMINE CHLOROARSINE         | 6.1               | -<br>P               | I              | -                  | 0  | E0                  | P002         | PP31         | -             | -             |
| 1699   | DIPHENYLCHLOROARSINE, LIQUID       | 6.1               | -<br>P               | I              | -                  | 0  | E0                  | P001         | PP31         | -             | -             |
| 1700   | TEAR GAS CANDLES                   | 6.1               | 4.1                  | -              | -                  | 0  | E0                  | P600         | -            | -             | -             |

| UN No. | Portable tanks and bulk containers |               | EmS                    | Stowage and handling           | Segregation                   | Properties and observations  | UN No. |
|--------|------------------------------------|---------------|------------------------|--------------------------------|-------------------------------|--|--------|
|        | Tank instructions                  | Provisions    |                        |                                |                               |  |        |
| (12)   | (13)<br>4.2.5<br>4.3               | (14)<br>4.2.5 | (15)<br>5.4.3.4<br>7.8 | (16a)<br>7.1<br>7.3-7.7        | (16b)<br>7.2-7.7              | (17)   | (18)   |
| -      | T3                                 | TP33          | F-A, S-A               | Category A                     | SGG7                          | Yellow powder. Insoluble in water. Toxic if swallowed, by skin contact or by dust inhalation.  | 1683   |
| -      | T3                                 | TP33          | F-A, S-A               | Category A<br>SW2              | SGG6<br>SGG7<br>SG35          | White powder. Insoluble in water. Reacts with acids or acid fumes, evolving hydrogen cyanide, a highly toxic and flammable gas. Toxic if swallowed, by skin contact or by dust inhalation.   | 1684   |
| -      | T3                                 | TP33          | F-A, S-A               | Category A                     | -                             | Colourless crystals. Soluble in water. Toxic if swallowed, by skin contact or by dust inhalation.  | 1685   |
| -      | T7                                 | TP2           | F-A, S-A               | Category A                     | -                             | Colourless. Toxic if swallowed, by skin contact or by inhalation.  | 1686   |
| -      | T4                                 | TP2           | F-A, S-A               | Category A                     | -                             | See entry above.   | 1686   |
| -      | -                                  | -             | F-A, S-A               | Category A                     | SGG17<br>SG15<br>SG30<br>SG35 | Colourless crystals. May react vigorously with acids to form hydrazoic acid, which is an explosive. May form extremely sensitive compounds with heavy metals or their salts. May explode if involved in a fire. Toxic if swallowed, by skin contact or by dust inhalation. | 1687   |
| -      | T3                                 | TP33          | F-A, S-A               | Category A                     | SG35                          | White, deliquescent solid with a foul odour. Reacts with acids, evolving dimethylarsine, an extremely toxic gas. Soluble in water. Toxic if swallowed, by skin contact or by dust inhalation.  | 1688   |
| -      | T6                                 | TP33          | F-A, S-A               | Category B                     | SGG6<br>SG35                  | White, deliquescent crystals or lumps. Soluble in water. Reacts with acids or acid fumes, evolving hydrogen cyanide, a highly toxic and flammable gas. Highly toxic if swallowed, by skin contact or by dust inhalation.   | 1689   |
| -      | T1                                 | TP33          | F-A, S-A               | Category A                     | SG35                          | White crystals or powder. React with acids, evolving hydrogen fluoride, a toxic, irritating and corrosive gas, apparent as white fumes. Toxic if swallowed, by skin contact or by inhalation.  | 1690   |
| -      | T3                                 | TP33          | F-A, S-A               | Category A                     | -                             | White powder. Soluble in water. Toxic if swallowed, by skin contact or by dust inhalation.   | 1691   |
| -      | T6                                 | TP33          | F-A, S-A               | Category A                     | -                             | White crystals or powder. Strychnine is slightly soluble; the salts are soluble in water. Highly toxic if swallowed, by skin contact or by dust inhalation.  | 1692   |
| -      | -                                  | -             | F-A, S-A               | Category D<br>SW2              | -                             | "Tear gas substance" is a generic term for substances which, in minute quantities dispersed in air, cause extreme eye irritation and profuse tears. Toxic if swallowed, by skin contact or by inhalation.  | 1693   |
| -      | -                                  | -             | F-A, S-A               | Category D<br>SW2              | -                             | See entry above.   | 1693   |
| -      | T14                                | TP2<br>TP13   | F-A, S-A               | Category D<br>SW1<br>SW2<br>H2 | SGG6<br>SG35                  | Volatile liquids evolving irritating vapour ("Tear Gas"). Melting points: <i>ortho</i> -BROMOBENZYL CYANIDE 1°C. Highly toxic if swallowed, by skin contact or by inhalation.  | 1694   |
| -      | T20                                | TP2<br>TP13   | F-E, S-C               | Category D<br>SW2              | SG5<br>SG8                    | Flammable, corrosive, colourless liquid, evolving irritating vapour ("Tear Gas"). Miscible with water. Flashpoint: 25°C c.c. Highly toxic if swallowed, by skin contact or by inhalation.  | 1695   |
| -      | T3                                 | TP33          | F-A, S-A               | Category D<br>SW1<br>SW2<br>H2 | -                             | White crystals evolving irritating vapour ("Tear Gas"). Melting point may be as low as 20°C. Toxic if swallowed, by skin contact or by inhalation.   | 1697   |
| -      | T6                                 | TP33          | F-A, S-A               | Category D<br>SW2              | -                             | Volatile, yellow crystals evolving irritating vapour ("Tear Gas"). Highly toxic if swallowed, by skin contact or by inhalation.  | 1698   |
| -      | -                                  | -             | F-A, S-A               | Category D<br>SW2              | -                             | When pure, colourless liquid. The commercial product may be a dark brown liquid. Volatile liquid evolving an irritating vapour ("Tear Gas"). Highly toxic if swallowed, by skin contact or by inhalation.  | 1699   |
| -      | -                                  | -             | F-A, S-G               | Category D<br>SW2              | -                             | Devices containing tear-producing substances which, in minute quantities dispersed in air, cause extreme eye irritation and profuse tears.   | 1700   |



Part 3 – Dangerous Goods List, special provisions and exceptions

Chapter 3.2 – Dangerous Goods List

| UN No. | Proper shipping name (PSN)  | Class or division | Subsidiary hazard(s) | Packing group  | Special provisions | Limited and excepted quantity provisions |                     | Packing      |              | IBC           |               |
|--------|---|-------------------|----------------------|----------------|--------------------|--|---------------------|--------------|--------------|---------------|---------------|
|        |   |                   |                      |                |                    | Limited quantities                       | Excepted quantities | Instructions | Provisions   | Instructions  | Provisions    |
| (1)    | (2)<br>3.1.2  | (3)<br>2.0        | (4)<br>2.0           | (5)<br>2.0.1.3 | (6)<br>3.3         | (7a)<br>3.4                              | (7b)<br>3.5         | (8)<br>4.1.4 | (9)<br>4.1.4 | (10)<br>4.1.4 | (11)<br>4.1.4 |
| 1701   | XYLYL BROMIDE, LIQUID   | 6.1               | –                    | II             | –                  | 0  | E0                  | P001         | PP31         | IBC02         | –             |
| 1702   | 1,1,2,2-TETRACHLOROETHANE   | 6.1               | –<br>P               | II             | –                  | 100 mL                                   | E4                  | P001         | –            | IBC02         | –             |
| 1704   | TETRAETHYL DITHIOPYROPHOSPHATE  | 6.1               | –<br>P               | II             | 43                 | 100 mL                                   | E4                  | P001         | –            | IBC02         | –             |
| 1707   | THALLIUM COMPOUND, N.O.S.   | 6.1               | –<br>P               | II             | 43<br>274          | 500 g                                    | E4                  | P002         | –            | IBC08         | B4<br>B21     |
| 1708   | TOLUIDINES, LIQUID  | 6.1               | –<br>P               | II             | 279                | 100 mL                                   | E4                  | P001         | –            | IBC02         | –             |
| 1709   | 2,4-TOLUYLENEDIAMINE, SOLID   | 6.1               | –                    | III            | –                  | 5 kg                                     | E1                  | P002<br>LP02 | –            | IBC08         | B3            |
| 1710   | TRICHLOROETHYLENE   | 6.1               | –                    | III            | –                  | 5 L                                      | E1                  | P001<br>LP01 | –            | IBC03         | –             |
| 1711   | XYLIDINES, LIQUID   | 6.1               | –                    | II             | –                  | 100 mL                                   | E4                  | P001         | –            | IBC02         | –             |
| 1712   | ZINC ARSENATE, ZINC ARSENITE or ZINC ARSENATE AND ZINC ARSENITE MIXTURE | 6.1               | –                    | II             | –                  | 500 g                                    | E4                  | P002         | –            | IBC08         | B4<br>B21     |
| 1713   | ZINC CYANIDE  | 6.1               | –<br>P               | I              | –                  | 0  | E5                  | P002         | –            | IBC07         | B1            |
| 1714   | ZINC PHOSPHIDE  | 4.3               | 6.1                  | I              | –                  | 0  | E0                  | P403         | PP31         | –             | –             |
| 1715   | ACETIC ANHYDRIDE  | 8                 | 3                    | II             | –                  | 1 L                                      | E2                  | P001         | –            | IBC02         | –             |
| 1716   | ACETYL BROMIDE  | 8                 | –                    | II             | –                  | 1 L                                      | E2                  | P001         | –            | IBC02         | B20           |
| 1717   | ACETYL CHLORIDE   | 3                 | 8                    | II             | –                  | 1 L                                      | E2                  | P001         | –            | IBC02         | B20           |
| 1718   | BUTYL ACID PHOSPHATE  | 8                 | –                    | III            | –                  | 5 L                                      | E1                  | P001<br>LP01 | –            | IBC03         | –             |
| 1719   | CAUSTIC ALKALI LIQUID, N.O.S.   | 8                 | –                    | II             | 274                | 1 L                                      | E2                  | P001         | –            | IBC02         | –             |
| 1719   | CAUSTIC ALKALI LIQUID, N.O.S.   | 8                 | –                    | III            | 223<br>274         | 5 L                                      | E1                  | P001         | –            | IBC03         | –             |
| 1722   | ALLYL CHLOROFORMATE   | 6.1               | 3/8                  | I              | –                  | 0  | E0                  | P001         | –            | –             | –             |

| UN No. | Portable tanks and bulk containers |               | EmS                    | Stowage and handling           | Segregation                        | Properties and observations  | UN No. |
|--------|------------------------------------|---------------|------------------------|--------------------------------|------------------------------------|--|--------|
|        | Tank instructions                  | Provisions    |                        |                                |                                    |  |        |
| (12)   | (13)<br>4.2.5<br>4.3               | (14)<br>4.2.5 | (15)<br>5.4.3.4<br>7.8 | (16a)<br>7.1<br>7.3–7.7        | (16b)<br>7.2–7.7                   | (17)   | (18)   |
| –      | T7                                 | TP2<br>TP13   | F-A, S-A               | Category D<br>SW2              | SGG10                              | Colourless liquid, evolving irritating vapour (“Tear Gas”). Toxic if swallowed, by skin contact or by inhalation.  | 1701   |
| –      | T7                                 | TP2           | F-A, S-A               | Category A<br>SW2              | SGG10                              | Colourless liquid with a chloroform-like odour. Toxic if swallowed, by skin contact or by inhalation.  | 1702   |
| –      | T7                                 | TP2           | F-A, S-A               | Category D<br>SW2              | –                                  | Colourless liquid. In the presence of moisture, corrosive to most metals. Toxic if swallowed, by skin contact or by inhalation.  | 1704   |
| –      | T3                                 | TP33          | F-A, S-A               | Category A                     | –                                  | White crystals or powder. Toxic if swallowed, by skin contact or by dust inhalation.   | 1707   |
| –      | T7                                 | TP2           | F-A, S-A               | Category A                     | –                                  | Colourless liquids. Toxic if swallowed, by skin contact or by inhalation.  | 1708   |
| –      | T1                                 | TP33          | F-A, S-A               | Category A                     | –                                  | White crystals or powder. Toxic if swallowed, by skin contact or by dust inhalation.   | 1709   |
| –      | T4                                 | TP1           | F-A, S-A               | Category A<br>SW2              | SGG10                              | Colourless liquid with a chloroform-like odour. When involved in a fire, evolves extremely toxic fumes (phosgene). Toxic if swallowed, by skin contact or by inhalation.   | 1710   |
| –      | T7                                 | TP2           | F-A, S-A               | Category A                     | –                                  | Toxic if swallowed, by skin contact or by inhalation.  | 1711   |
| –      | T3                                 | TP33          | F-A, S-A               | Category A                     | SGG7                               | Crystalline solid. Insoluble in water. Toxic if swallowed, by skin contact or by dust inhalation.  | 1712   |
| –      | T6                                 | TP33          | F-A, S-A               | Category A                     | SGG6<br>SGG7<br>SG35               | White crystals or powder. Insoluble in water. Reacts with acids or acid fumes, evolving hydrogen cyanide, a highly toxic and flammable gas. Highly toxic if swallowed, by skin contact or by dust inhalation.  | 1713   |
| –      | –                                  | –             | F-G, S-N               | Category E<br>SW2<br>SW5<br>H1 | SGG7<br>SG26<br>SG35               | Grey crystals or powder. Reacts with acids or decomposes slowly in contact with water or damp air, evolving phosphine, a spontaneously flammable and highly toxic gas. Reacts violently with oxidizing substances.   | 1714   |
| –      | T7                                 | TP2           | F-E, S-C               | Category A<br>SW2              | SGG1<br>SG36<br>SG49               | Colourless, flammable liquid with an irritating odour. Flashpoint: 54°C c.c. Immiscible with water. In the presence of moisture, corrosive to most metals. Vapour irritates mucous membranes.  | 1715   |
| –      | T8                                 | TP2           | F-A, S-B               | Category C<br>SW2              | SGG1<br>SG36<br>SG49               | Colourless liquid. Reacts violently with water, evolving hydrogen bromide, an irritating and corrosive gas apparent as white fumes. In the presence of moisture, highly corrosive to most metals. Vapour irritates mucous membranes.   | 1716   |
| –      | T8                                 | TP2           | F-E, S-C               | Category B<br>SW2              | SGG1<br>SG36<br>SG49               | Colourless liquid. Flashpoint: 5°C c.c. Boiling point: 51°C. Reacts violently with water, evolving hydrogen chloride, an irritating and corrosive gas apparent as white fumes. In the presence of moisture, highly corrosive to most metals. Causes burns to skin, eyes and mucous membranes.                    | 1717   |
| –      | T4                                 | TP1           | F-A, S-B               | Category A                     | SGG1<br>SG36<br>SG49               | Yellow liquid. Insoluble in water. Mildly corrosive to most metals.  | 1718   |
| –      | T11                                | TP2<br>TP27   | F-A, S-B               | Category A                     | SGG18<br>SG22<br>SG35              | Corrosive to aluminium, zinc and tin. Reacts violently with acids. Reacts with ammonium salts, evolving ammonia gas. Causes burns to skin, eyes and mucous membranes.  | 1719   |
| –      | T7                                 | TP1<br>TP28   | F-A, S-B               | Category A                     | SGG18<br>SG22<br>SG35              | See entry above.   | 1719   |
| –      | T14                                | TP2<br>TP13   | F-E, S-C               | Category D<br>SW2              | SGG1<br>SG5<br>SG8<br>SG36<br>SG49 | Colourless, flammable liquid, extremely irritating odour, causes tears. Flashpoint: 31°C c.c. When involved in a fire, evolves toxic gases. In the presence of moisture, corrosive to most metals. Highly toxic if swallowed, by skin contact or by inhalation. Causes burns to skin, eyes and mucous membranes. | 1722   |

Part 3 – Dangerous Goods List, special provisions and exceptions

Chapter 3.2 – Dangerous Goods List

| UN No. | Proper shipping name (PSN)         | Class or division | Subsidiary hazard(s) | Packing group  | Special provisions | Limited and excepted quantity provisions |                     | Packing      |              | IBC           |               |
|--------|------------------------------------|-------------------|----------------------|----------------|--------------------|--|---------------------|--------------|--------------|---------------|---------------|
|        |                                    |                   |                      |                |                    | Limited quantities                       | Excepted quantities | Instructions | Provisions   | Instructions  | Provisions    |
| (1)    | (2)<br>3.1.2                       | (3)<br>2.0        | (4)<br>2.0           | (5)<br>2.0.1.3 | (6)<br>3.3         | (7a)<br>3.4                              | (7b)<br>3.5         | (8)<br>4.1.4 | (9)<br>4.1.4 | (10)<br>4.1.4 | (11)<br>4.1.4 |
| 1723   | ALLYL IODIDE                       | 3                 | 8                    | II             | –                  | 1 L                                      | E2                  | P001         | –            | IBC02         | –             |
| 1724   | ALLYLTRICHLOROSILANE, STABILIZED   | 8                 | 3                    | II             | 386                | 0  | E0                  | P010         | –            | –             | –             |
| 1725   | ALUMINIUM BROMIDE, ANHYDROUS       | 8                 | –                    | II             | 937                | 1 kg                                     | E2                  | P002         | –            | IBC08         | B4<br>B21     |
| 1726   | ALUMINIUM CHLORIDE, ANHYDROUS      | 8                 | –                    | II             | 937                | 1 kg                                     | E2                  | P002         | –            | IBC08         | B4<br>B21     |
| 1727   | AMMONIUM HYDROGENDIFLUORIDE, SOLID | 8                 | –                    | II             | –                  | 1 kg                                     | E2                  | P002         | –            | IBC08         | B4<br>B21     |
| 1728   | AMYLTRICHLOROSILANE                | 8                 | –                    | II             | –                  | 0  | E0                  | P010         | –            | –             | –             |
| 1729   | ANISOYL CHLORIDE                   | 8                 | –                    | II             | –                  | 1 kg                                     | E2                  | P002         | –            | IBC08         | B4<br>B21     |
| 1730   | ANTIMONY PENTACHLORIDE, LIQUID     | 8                 | –                    | II             | –                  | 1 L                                      | E2                  | P001         | –            | IBC02         | –             |
| 1731   | ANTIMONY PENTACHLORIDE SOLUTION    | 8                 | –                    | II             | –                  | 1 L                                      | E2                  | P001         | –            | IBC02         | –             |
| 1731   | ANTIMONY PENTACHLORIDE SOLUTION    | 8                 | –                    | III            | 223                | 5 L                                      | E1                  | P001<br>LP01 | –            | IBC03         | –             |
| 1732   | ANTIMONY PENTAFLUORIDE             | 8                 | 6.1                  | II             | –                  | 1 L                                      | E0                  | P001         | –            | IBC02         | –             |
| 1733   | ANTIMONY TRICHLORIDE               | 8                 | –                    | II             | –                  | 1 kg                                     | E2                  | P002         | –            | IBC08         | B4<br>B21     |

| UN No. | Portable tanks and bulk containers |                    | EmS                    | Stowage and handling     | Segregation  | Properties and observations  | UN No. |
|--------|------------------------------------|--------------------|------------------------|--------------------------|--|--|--------|
|        | Tank instructions                  | Provisions         |                        |                          |  |  |        |
| (12)   | (13)<br>4.2.5<br>4.3               | (14)<br>4.2.5      | (15)<br>5.4.3.4<br>7.8 | (16a)<br>7.1<br>7.3–7.7  | (16b)<br>7.2–7.7                                   | (17)   | (18)   |
| –      | T7                                 | TP2<br>TP13        | F-E, S-C               | Category B<br>SW2        | SGG1<br>SGG10<br>SG36<br>SG49                      | Yellow liquid with an irritating odour. Flashpoint: 5°C c.c. Immiscible with water. In the presence of moisture, corrosive to most metals. Causes burns to skin, eyes and mucous membranes.  | 1723   |
| –      | T10                                | TP2<br>TP7<br>TP13 | F-E, S-C               | Category C<br>SW1<br>SW2 | SGG1<br>SG36<br>SG49                               | Colourless, flammable liquid with a pungent odour. Flashpoint: 35°C c.c. Reacts violently with water, evolving hydrogen chloride, an irritating and corrosive gas, apparent as white fumes. When involved in a fire, evolves toxic gases. In the presence of moisture, highly corrosive to most metals. Causes burns to skin, eyes and mucous membranes.   | 1724   |
| –      | T3                                 | TP33               | F-A, S-B               | Category A<br>SW2        | SGG1<br>SG36<br>SG49                               | White to yellowish hygroscopic crystals. Forms corrosive vapours in moist air. Reacts violently with water, evolving heat and hydrogen bromide, an irritating and corrosive gas apparent as white fumes. In the presence of moisture, highly corrosive to most metals. Highly irritating to skin, eyes and mucous membranes. The solid hydrated form of this substance is not subject to the provisions of this Code.  | 1725   |
| –      | T3                                 | TP33               | F-A, S-B               | Category A<br>SW2        | SGG1<br>SG36<br>SG49                               | White to yellowish hygroscopic crystals. Forms corrosive vapours in moist air. Reacts violently with water, evolving heat and hydrogen chloride, an irritating and corrosive gas apparent as white fumes. In the presence of moisture, highly corrosive to most metals. Highly irritating to skin, eyes and mucous membranes. The solid hydrated form of this substance is not subject to the provisions of this Code.   | 1726   |
| –      | T3                                 | TP33               | F-A, S-B               | Category A<br>SW1<br>SW2 | SGG1<br>SGG2<br>SG35<br>SG36<br>SG49               | White deliquescent crystals. Decomposed by heat or acids, evolving hydrogen fluoride, a toxic, extremely irritating and corrosive gas, apparent as white fumes. In the presence of moisture, highly corrosive to glass, other siliceous materials and most metals. Causes burns to skin and mucous membranes.  | 1727   |
| –      | T10                                | TP2<br>TP7<br>TP13 | F-A, S-B               | Category C<br>SW2        | SGG1<br>SG36<br>SG49                               | Colourless liquid with a pungent odour. Reacts violently with water, evolving hydrogen chloride, an irritating and corrosive gas apparent as white fumes. When involved in a fire, evolves toxic gases. In the presence of moisture, highly corrosive to most metals. Vapour irritates mucous membranes.   | 1728   |
| –      | T3                                 | TP33               | F-A, S-B               | Category C<br>SW2        | SGG1<br>SG36<br>SG49                               | Crystalline powder. Melting point: 22°C. Reacts violently with water, evolving hydrogen chloride, an irritating and corrosive gas apparent as white fumes. In the presence of moisture, highly corrosive to most metals. Vapour irritates mucous membranes.  | 1729   |
| –      | T7                                 | TP2                | F-A, S-B               | Category C<br>SW2        | SGG1<br>SG36<br>SG49                               | Yellow, oily liquid with an offensive odour. May solidify by absorption of moisture. Reacts violently with water, evolving hydrogen chloride, an irritating and corrosive gas apparent as white fumes. In the presence of moisture, highly corrosive to most metals. Causes burns to skin, eyes and mucous membranes.  | 1730   |
| –      | T7                                 | TP2                | F-A, S-B               | Category C<br>SW2        | SGG1<br>SG36<br>SG49                               | Yellow liquid with an offensive odour. Corrosive to most metals. Causes burns to skin, eyes and mucous membranes.  | 1731   |
| –      | T4                                 | TP1                | F-A, S-B               | Category C<br>SW2        | SGG1<br>SG36<br>SG49                               | See entry above.   | 1731   |
| –      | T7                                 | TP2                | F-A, S-B               | Category D<br>SW2        | SGG1<br>SG6<br>SG8<br>SG10<br>SG12<br>SG36<br>SG49 | Colourless liquid with a pungent odour. When anhydrous, mildly corrosive to glass, other siliceous materials and most metals. Reacts violently with water, evolving hydrogen fluoride, an irritating gas, highly corrosive to glass and other siliceous materials and most metals. Powerful oxidant, may cause fire in contact with readily flammable organic substances. Toxic if swallowed, by skin contact or by inhalation. Causes burns to skin and mucous membranes. | 1732   |
| –      | T3                                 | TP33               | F-A, S-B               | Category C<br>SW2        | SGG1<br>SG36<br>SG49                               | Reacts slowly with water, evolving hydrogen chloride, an irritating and corrosive gas. In the presence of moisture, corrosive to most metals.  | 1733   |

Part 3 – Dangerous Goods List, special provisions and exceptions

Chapter 3.2 – Dangerous Goods List

| UN No. | Proper shipping name (PSN)                       | Class or division | Subsidiary hazard(s) | Packing group  | Special provisions | Limited and excepted quantity provisions |                     | Packing      |              | IBC           |               |
|--------|--|-------------------|----------------------|----------------|--------------------|--|---------------------|--------------|--------------|---------------|---------------|
|        |  |                   |                      |                |                    | Limited quantities                       | Excepted quantities | Instructions | Provisions   | Instructions  | Provisions    |
| (1)    | (2)<br>3.1.2                                     | (3)<br>2.0        | (4)<br>2.0           | (5)<br>2.0.1.3 | (6)<br>3.3         | (7a)<br>3.4                              | (7b)<br>3.5         | (8)<br>4.1.4 | (9)<br>4.1.4 | (10)<br>4.1.4 | (11)<br>4.1.4 |
| 1736   | BENZOYL CHLORIDE                                 | 8                 | –                    | II             | –                  | 1 L                                      | E2                  | P001         | –            | IBC02         | B20           |
| 1737   | BENZYL BROMIDE                                   | 6.1               | 8                    | II             | –                  | 0  | E4                  | P001         | –            | IBC02         | B20           |
| 1738   | BENZYL CHLORIDE                                  | 6.1               | 8                    | II             | –                  | 0  | E4                  | P001         | –            | IBC02         | B20           |
| 1739   | BENZYL CHLOROFORMATE                             | 8                 | –<br>P               | I              | –                  | 0  | E0                  | P001         | –            | –             | –             |
| 1740   | HYDROGENDIFLUORIDES, SOLID, N.O.S.               | 8                 | –                    | II             | –                  | 1 kg                                     | E2                  | P002         | –            | IBC08         | B4<br>B21     |
| 1740   | HYDROGENDIFLUORIDES, SOLID, N.O.S.               | 8                 | –                    | III            | 223                | 5 kg                                     | E1                  | P002<br>LP02 | –            | IBC08         | B3            |
| 1741   | BORON TRICHLORIDE                                | 2.3               | 8                    | –              | –                  | 0  | E0                  | P200         | –            | –             | –             |
| 1742   | BORON TRIFLUORIDE ACETIC ACID COMPLEX, LIQUID    | 8                 | –                    | II             | –                  | 1 L                                      | E2                  | P001         | –            | IBC02         | B20           |
| 1743   | BORON TRIFLUORIDE PROPIONIC ACID COMPLEX, LIQUID | 8                 | –                    | II             | –                  | 500 mL                                   | E2                  | P001         | –            | IBC02         | B20           |
| 1744   | BROMINE or BROMINE SOLUTION                      | 8                 | 6.1                  | I              | –                  | 0  | E0                  | P804         | –            | –             | –             |
| 1745   | BROMINE PENTAFLUORIDE                            | 5.1               | 6.1/8                | I              | –                  | 0  | E0                  | P200         | –            | –             | –             |

| (12)                 | Portable tanks and bulk containers |                        | EmS                     | Stowage and handling           | Segregation   | Properties and observations   | UN No. |
|----------------------|------------------------------------|------------------------|-------------------------|--------------------------------|---|---|--------|
|                      | Tank instructions                  | Provisions             |                         |                                |   |   |        |
| (13)<br>4.2.5<br>4.3 | (14)<br>4.2.5                      | (15)<br>5.4.3.4<br>7.8 | (16a)<br>7.1<br>7.3–7.7 | (16b)<br>7.2–7.7               | (17)  | (18)  |        |
| –                    | T8                                 | TP2<br>TP13            | F-A, S-B                | Category C<br>SW2              | SGG1<br>SG36<br>SG49                                | Colourless liquid, very irritating odour, causes tears. Reacts violently with water, evolving hydrogen chloride, an irritating and corrosive gas apparent as white fumes. In the presence of moisture, highly corrosive to most metals. Vapour irritates mucous membranes.  | 1736   |
| –                    | T8                                 | TP2<br>TP13            | F-A, S-B                | Category D<br>SW2<br>H1        | SGG1<br>SGG10<br>SG36<br>SG49                       | Colourless liquid with a pungent odour, causes tears. In the presence of moisture, corrosive to most metals. Toxic if swallowed, by skin contact or by inhalation. Causes burns to skin, eyes and mucous membranes.   | 1737   |
| –                    | T8                                 | TP2<br>TP13            | F-A, S-B                | Category D<br>SW2<br>H1        | SGG1<br>SGG10<br>SG36<br>SG49                       | Colourless liquid with a pungent odour. Causes tears. Immiscible with water, but hydrolyses slowly in contact with it. In the presence of moisture, corrosive to most metals. Toxic if swallowed, by skin contact or by vapour inhalation. Causes burns to skin, eyes and mucous membranes.   | 1738   |
| –                    | T10                                | TP2<br>TP13            | F-A, S-B                | Category D<br>SW2              | SGG1<br>SG36<br>SG49                                | Colourless liquid with an irritating odour. Reacts with water. When involved in a fire, evolves toxic gases. In the presence of moisture, highly corrosive to most metals. Causes severe burns to skin, eyes and mucous membranes.  | 1739   |
| –                    | T3                                 | TP33                   | F-A, S-B                | Category A<br>SW1<br>SW2       | SGG1<br>SG35<br>SG36<br>SG49                        | Crystalline solids. Decomposed by heat or acid, evolving hydrogen fluoride, an extremely irritating and corrosive gas. In the presence of moisture, corrosive to glass, other siliceous materials and most metals. Cause burns to skin, eyes and mucous membranes.  | 1740   |
| –                    | T1                                 | TP33                   | F-A, S-B                | Category A<br>SW1<br>SW2       | SGG1<br>SG35<br>SG36<br>SG49                        | See entry above.  | 1740   |
| –                    | –                                  | –                      | F-C, S-U                | Category D<br>SW1<br>SW2       | –   | Non-flammable, toxic and corrosive gas. Forms dense white corrosive fumes in moist air. Reacts violently with water, evolving hydrogen chloride, an irritating and corrosive gas apparent as white fumes. In the presence of moisture, highly corrosive to most metals. Much heavier than air (2.35). Highly irritating to skin, eyes and mucous membranes.   | 1741   |
| –                    | T8                                 | TP2                    | F-A, S-B                | Category A                     | SGG1<br>SG36<br>SG49                                | Highly corrosive to most metals. Causes burns to skin, eyes and mucous membranes.   | 1742   |
| –                    | T8                                 | TP2                    | F-A, S-B                | Category A                     | SGG1<br>SG36<br>SG49                                | Highly corrosive to most metals. Causes burns to skin, eyes and mucous membranes.   | 1743   |
| –                    | T22                                | TP2<br>TP10<br>TP13    | F-A, S-B                | Category D<br>SW1<br>SW2<br>H2 | SGG1<br>SG6<br>SG16<br>SG17<br>SG19<br>SG36<br>SG49 | Very dark brown, heavy liquid with an extremely irritating odour. Density: 3.1 (pure product). Boiling point: 59°C. Powerful oxidant; may cause fire in contact with organic materials such as wood, cotton or straw. Highly corrosive to most metals. Solutions have the same properties to a lesser degree, depending on concentration. Toxic if swallowed, by skin contact or by inhalation. Causes burns to skin, eyes and mucous membranes.  | 1744   |
| –                    | T22                                | TP2<br>TP13            | F-A, S-B                | Category D<br>SW1<br>SW2       | SGG1<br>SG6<br>SG16<br>SG19<br>SG36<br>SG49         | Colourless, heavy liquid with an extremely irritating odour. Boiling point: 40°C. Powerful oxidant; may cause fire in contact with organic material such as wood, cotton or straw. Reacts violently with water, evolving hydrogen fluoride, a toxic, extremely corrosive gas apparent as white fumes. In contact with acids or acid fumes, evolves highly toxic fumes of bromine, fluorine and their compounds. Highly corrosive to most metals. Toxic if swallowed, by skin contact or by inhalation. Causes burns to skin, eyes and mucous membranes. | 1745   |



| UN No. | Proper shipping name (PSN)   | Class or division | Subsidiary hazard(s) | Packing group  | Special provisions | Limited and excepted quantity provisions |                     | Packing      |              | IBC           |               |
|--------|--|-------------------|----------------------|----------------|--------------------|--|---------------------|--------------|--------------|---------------|---------------|
|        |  |                   |                      |                |                    | Limited quantities                       | Excepted quantities | Instructions | Provisions   | Instructions  | Provisions    |
| (1)    | (2)<br>3.1.2   | (3)<br>2.0        | (4)<br>2.0           | (5)<br>2.0.1.3 | (6)<br>3.3         | (7a)<br>3.4                              | (7b)<br>3.5         | (8)<br>4.1.4 | (9)<br>4.1.4 | (10)<br>4.1.4 | (11)<br>4.1.4 |
| 1746   | BROMINE TRIFLUORIDE  | 5.1               | 6.1/8                | I              | –                  | 0  | E0                  | P200         | –            | –             | –             |
| 1747   | BUTYLTRICHLOROSILANE   | 8                 | 3                    | II             | –                  | 0  | E0                  | P010         | –            | –             | –             |
| 1748   | CALCIUM HYPOCHLORITE, DRY or CALCIUM HYPOCHLORITE MIXTURE, DRY with more than 39% available chlorine (8.8% available oxygen) | 5.1               | –<br>P               | II             | 314                | 1 kg                                     | E2                  | P002         | PP85         | –             | –             |
| 1748   | CALCIUM HYPOCHLORITE, DRY or CALCIUM HYPOCHLORITE MIXTURE, DRY with more than 39% available chlorine (8.8% available oxygen) | 5.1               | –<br>P               | III            | 316                | 5 kg                                     | E1                  | P002         | PP85         | –             | –             |
| 1749   | CHLORINE TRIFLUORIDE   | 2.3               | 5.1/8                | –              | –                  | 0  | E0                  | P200         | –            | –             | –             |
| 1750   | CHLOROACETIC ACID SOLUTION   | 6.1               | 8                    | II             | –                  | 100 mL                                   | E4                  | P001         | –            | IBC02         | –             |
| 1751   | CHLOROACETIC ACID, SOLID   | 6.1               | 8                    | II             | –                  | 500 g                                    | E4                  | P002         | –            | IBC08         | B4<br>B21     |
| 1752   | CHLOROACETYL CHLORIDE  | 6.1               | 8                    | I              | 354                | 0  | E0                  | P602         | –            | –             | –             |
| 1753   | CHLOROPHENYL-TRICHLOROSILANE   | 8                 | –<br>P               | II             | –                  | 0  | E2                  | P010         | –            | –             | –             |
| 1754   | CHLOROSULPHONIC ACID (with or without sulphur trioxide)  | 8                 | –                    | I              | –                  | 0  | E0                  | P001         | –            | –             | –             |

| UN No. | Portable tanks and bulk containers |                    | EmS                    | Stowage and handling      | Segregation                                  | Properties and observations   | UN No. |
|--------|------------------------------------|--------------------|------------------------|---------------------------|--|---|--------|
|        | Tank instructions                  | Provisions         |                        |                           |  |   |        |
| (12)   | (13)<br>4.2.5<br>4.3               | (14)<br>4.2.5      | (15)<br>5.4.3.4<br>7.8 | (16a)<br>7.1<br>7.3–7.7   | (16b)<br>7.2–7.7                             | (17)  | (18)   |
| –      | T22                                | TP2<br>TP13        | F-A, S-B               | Category D<br>SW1<br>SW2  | SGG1<br>SG6<br>SG16<br>SG19<br>SG36<br>SG49  | Colourless, heavy liquid with an extremely irritating odour. Powerful oxidant; may cause fire in contact with organic material such as wood, cotton or straw. Reacts violently with water, evolving hydrogen fluoride, a toxic, extremely corrosive gas apparent as white fumes. In contact with acids or acid fumes, evolves highly toxic fumes of bromine, fluorine and their compounds. Highly corrosive to most metals. Toxic if swallowed, by skin contact or by inhalation. Causes burns to skin, eyes and mucous membranes.  | 1746   |
| –      | T10                                | TP2<br>TP7<br>TP13 | F-E, S-C               | Category C<br>SW2         | SGG1<br>SG36<br>SG49                         | Colourless, flammable liquid with a pungent odour. Flashpoint: 52°C c.c. Reacts violently with water, evolving hydrogen chloride, an irritating and corrosive gas apparent as white fumes. When involved in a fire, evolves toxic gases. In the presence of moisture, highly corrosive to most metals. Vapour irritates mucous membranes.   | 1747   |
| –      | –                                  | –                  | F-H, S-Q               | Category D<br>SW1<br>SW11 | SGG8<br>SG35<br>SG38<br>SG49<br>SG53<br>SG60 | White or yellowish solid (powder, granules or tablets) with chlorine-like odour. Soluble in water. May cause fire in contact with organic material or ammonium compounds. Substances are liable to exothermic decomposition at elevated temperatures. This condition may lead to fire or explosion. Decomposition can be initiated by heat or by impurities (e.g. powdered metals (iron, manganese, cobalt, magnesium) and their compounds). Liable to heat slowly. Reacts with acids, evolving chlorine, an irritating, corrosive and toxic gas. In the presence of moisture, corrosive to most metals. Dust irritates mucous membranes. | 1748   |
| –      | –                                  | –                  | F-H, S-Q               | Category D<br>SW1<br>SW11 | SGG8<br>SG35<br>SG38<br>SG49<br>SG53<br>SG60 | See entry above.  | 1748   |
| –      | –                                  | –                  | F-C, S-W               | Category D<br>SW2         | SG6<br>SG19                                  | Non-flammable, toxic and corrosive gas. Forms dense, white, corrosive fumes in moist air. Reacts violently with water, evolving hydrogen fluoride, an irritating and corrosive gas apparent as white fumes. Corrosive to glass and to most metals. Powerful oxidizing agent which may cause fires with combustible materials. Much heavier than air. Highly irritating to skin, eyes and mucous membranes.  | 1749   |
| –      | T7                                 | TP2                | F-A, S-B               | Category C<br>SW2         | SGG1<br>SG36<br>SG49                         | Colourless liquid. Corrosive to most metals. Toxic if swallowed, by skin contact or by inhalation. Causes burns to skin, eyes and mucous membranes.   | 1750   |
| –      | T3                                 | TP33               | F-A, S-B               | Category C<br>SW2         | SGG1<br>SG36<br>SG49                         | Colourless, very deliquescent crystals. Melting point may be as low as 50°C. In the presence of moisture, corrosive to most metals. Toxic if swallowed, by skin contact or by dust inhalation. Causes burns to skin, eyes and mucous membranes.   | 1751   |
| –      | T20                                | TP2<br>TP13        | F-A, S-B               | Category D<br>SW2         | SGG1<br>SG36<br>SG49                         | Colourless liquid, with extremely irritating odour, causing tears. Reacts violently with water, evolving hydrogen chloride, an irritating and corrosive gas apparent as white fumes. In the presence of moisture, highly corrosive to most metals. Highly toxic if swallowed, by skin contact or by inhalation. Causes burns to skin, eyes and mucous membranes.  | 1752   |
| –      | T10                                | TP2<br>TP7         | F-A, S-B               | Category C<br>SW2         | SGG1<br>SG36<br>SG49                         | Colourless liquid with a pungent odour. Reacts violently with water, evolving hydrogen chloride, an irritating and corrosive gas apparent as white fumes. When involved in a fire, evolves toxic gases. In the presence of moisture, highly corrosive to most metals. Irritating to skin, eyes and mucous membranes.  | 1753   |
| –      | T20                                | TP2                | F-A, S-B               | Category C<br>SW2         | SGG1<br>SG36<br>SG49                         | Colourless liquid with a pungent odour. Reacts violently with water, evolving hydrogen chloride, an irritating and corrosive gas apparent as white fumes. In the presence of moisture, highly corrosive to most metals. Causes severe burns to skin, eyes and mucous membranes.   | 1754   |

Part 3 – Dangerous Goods List, special provisions and exceptions

Chapter 3.2 – Dangerous Goods List

| UN No. | Proper shipping name (PSN)    | Class or division | Subsidiary hazard(s) | Packing group  | Special provisions | Limited and excepted quantity provisions |                     | Packing      |              | IBC           |               |
|--------|-------------------------------|-------------------|----------------------|----------------|--------------------|--|---------------------|--------------|--------------|---------------|---------------|
|        |                               |                   |                      |                |                    | Limited quantities                       | Excepted quantities | Instructions | Provisions   | Instructions  | Provisions    |
| (1)    | (2)<br>3.1.2                  | (3)<br>2.0        | (4)<br>2.0           | (5)<br>2.0.1.3 | (6)<br>3.3         | (7a)<br>3.4                              | (7b)<br>3.5         | (8)<br>4.1.4 | (9)<br>4.1.4 | (10)<br>4.1.4 | (11)<br>4.1.4 |
| 1755   | CHROMIC ACID SOLUTION         | 8                 | –                    | II             | –                  | 1 L                                      | E2                  | P001         | –            | IBC02         | B20           |
| 1755   | CHROMIC ACID SOLUTION         | 8                 | –                    | III            | 223                | 5 L                                      | E1                  | P001<br>LP01 | –            | IBC03         | –             |
| 1756   | CHROMIC FLUORIDE, SOLID       | 8                 | –                    | II             | –                  | 1 kg                                     | E2                  | P002         | –            | IBC08         | B4<br>B21     |
| 1757   | CHROMIC FLUORIDE SOLUTION     | 8                 | –                    | II             | –                  | 1 L                                      | E2                  | P001         | –            | IBC02         | –             |
| 1757   | CHROMIC FLUORIDE SOLUTION     | 8                 | –                    | III            | 223                | 5 L                                      | E1                  | P001<br>LP01 | –            | IBC03         | –             |
| 1758   | CHROMIUM OXYCHLORIDE          | 8                 | –                    | I              | –                  | 0  | E0                  | P001         | –            | –             | –             |
| 1759   | CORROSIVE SOLID, N.O.S.       | 8                 | –                    | I              | 274                | 0  | E0                  | P002         | –            | IBC07         | B1            |
| 1759   | CORROSIVE SOLID, N.O.S.       | 8                 | –                    | II             | 274                | 1 kg                                     | E2                  | P002         | –            | IBC08         | B4<br>B21     |
| 1759   | CORROSIVE SOLID, N.O.S.       | 8                 | –                    | III            | 223<br>274         | 5 kg                                     | E1                  | P002<br>LP02 | –            | IBC08         | B3            |
| 1760   | CORROSIVE LIQUID, N.O.S.      | 8                 | –                    | I              | 274                | 0  | E0                  | P001         | –            | –             | –             |
| 1760   | CORROSIVE LIQUID, N.O.S.      | 8                 | –                    | II             | 274                | 1 L                                      | E2                  | P001         | –            | IBC02         | –             |
| 1760   | CORROSIVE LIQUID, N.O.S.      | 8                 | –                    | III            | 223<br>274         | 5 L                                      | E1                  | P001<br>LP01 | –            | IBC03         | –             |
| 1761   | CUPRIETHYLENEDIAMINE SOLUTION | 8                 | 6.1<br>P             | II             | –                  | 1 L                                      | E2                  | P001         | –            | IBC02         | –             |
| 1761   | CUPRIETHYLENEDIAMINE SOLUTION | 8                 | 6.1<br>P             | III            | 223                | 5 L                                      | E1                  | P001         | –            | IBC03         | –             |
| 1762   | CYCLOHEXYLTRICHLORO-SILANE    | 8                 | –                    | II             | –                  | 0  | E0                  | P010         | –            | –             | –             |
| 1763   | CYCLOHEXYLTRICHLORO-SILANE    | 8                 | –                    | II             | –                  | 0  | E0                  | P010         | –            | –             | –             |

| UN No. | Portable tanks and bulk containers |                    | EmS                    | Stowage and handling    | Segregation   | Properties and observations  | UN No. |
|--------|------------------------------------|--------------------|------------------------|-------------------------|---|--|--------|
|        | Tank instructions                  | Provisions         |                        |                         |   |  |        |
| (12)   | (13)<br>4.2.5<br>4.3               | (14)<br>4.2.5      | (15)<br>5.4.3.4<br>7.8 | (16a)<br>7.1<br>7.3–7.7 | (16b)<br>7.2–7.7                                    | (17)   | (18)   |
| –      | T8                                 | TP2                | F-A, S-B               | Category C<br>SW2       | SGG1<br>SG6<br>SG8<br>SG10<br>SG12<br>SG36<br>SG49  | Orange liquid. Powerful oxidant. May cause fire in contact with organic materials such as wood, cotton or straw. Highly corrosive to most metals. Causes burns to skin, eyes and mucous membranes.   | 1755   |
| –      | T4                                 | TP1                | F-A, S-B               | Category C<br>SW2       | SGG1<br>SG6<br>SG8<br>SG10<br>SG12<br>SG36<br>SG49  | See entry above.   | 1755   |
| –      | T3                                 | TP33               | F-A, S-B               | Category A              | SGG1<br>SG35<br>SG36<br>SG49                        | Green or violet crystals. Slightly soluble in water. Reacts with acids, evolving hydrogen fluoride, an extremely irritating and corrosive gas. Mildly corrosive to most metals. Causes burns to skin, eyes and mucous membranes.   | 1756   |
| –      | T7                                 | TP2                | F-A, S-B               | Category A              | SGG1<br>SG36<br>SG49                                | Green liquid. Reacts with acids, evolving hydrogen fluoride, an extremely irritating and corrosive gas. Mildly corrosive to most metals. Causes burns to skin, eyes and mucous membranes.  | 1757   |
| –      | T4                                 | TP1                | F-A, S-B               | Category A              | SGG1<br>SG36<br>SG49                                | See entry above.   | 1757   |
| –      | T10                                | TP2                | F-A, S-B               | Category C<br>SW2       | SGG1<br>SG6<br>SG16<br>SG17<br>SG19<br>SG36<br>SG49 | Dark red liquid. Reacts violently with water, evolving hydrogen chloride and chlorine, both highly irritating and corrosive gases apparent as white fumes. Oxidant; may cause fire in contact with organic materials such as wood, cotton or straw. Highly corrosive to most metals. Causes severe burns to skin, eyes and mucous membranes. | 1758   |
| –      | T6                                 | TP33               | F-A, S-B               | Category B              | –   | Causes burns to skin, eyes and mucous membranes.   | 1759   |
| –      | T3                                 | TP33               | F-A, S-B               | Category A              | –   | See entry above.   | 1759   |
| –      | T1                                 | TP33               | F-A, S-B               | Category A              | –   | See entry above.   | 1759   |
| –      | T14                                | TP2<br>TP27        | F-A, S-B               | Category B<br>SW2       | –   | Causes burns to skin, eyes and mucous membranes.   | 1760   |
| –      | T11                                | TP2<br>TP27        | F-A, S-B               | Category B<br>SW2       | –   | See entry above.   | 1760   |
| –      | T7                                 | TP1<br>TP28        | F-A, S-B               | Category A<br>SW2       | –   | See entry above.   | 1760   |
| –      | T7                                 | TP2                | F-A, S-B               | Category A              | SG35  | Dark purple liquid with an ammonia-like odour. Corrosive to copper, aluminium, zinc and tin. Toxic if swallowed, by skin contact or by inhalation. Causes burns to skin, eyes and mucous membranes.  | 1761   |
| –      | T7                                 | TP1<br>TP28        | F-A, S-B               | Category A              | SG35  | See entry above.   | 1761   |
| –      | T10                                | TP2<br>TP7<br>TP13 | F-A, S-B               | Category C<br>SW2       | SGG1<br>SG36<br>SG49                                | Colourless liquid with a pungent odour. Reacts violently with water, evolving hydrogen chloride, an irritating and corrosive gas apparent as white fumes. When involved in a fire, evolves toxic gases. In the presence of moisture, highly corrosive to most metals. Causes burns to skin, eyes and mucous membranes.                       | 1762   |
| –      | T10                                | TP2<br>TP7<br>TP13 | F-A, S-B               | Category C<br>SW2       | SGG1<br>SG36<br>SG49                                | Colourless liquid with a pungent odour. Reacts violently with water, evolving hydrogen chloride, an irritating and corrosive gas apparent as white fumes. When involved in a fire, evolves toxic gases. In the presence of moisture, highly corrosive to most metals. Vapour irritates mucous membranes.                                     | 1763   |

| UN No. | Proper shipping name (PSN)                   | Class or division | Subsidiary hazard(s) | Packing group  | Special provisions | Limited and excepted quantity provisions |                     | Packing      |              | IBC           |               |
|--------|--|-------------------|----------------------|----------------|--------------------|--|---------------------|--------------|--------------|---------------|---------------|
|        |  |                   |                      |                |                    | Limited quantities                       | Excepted quantities | Instructions | Provisions   | Instructions  | Provisions    |
| (1)    | (2)<br>3.1.2                                 | (3)<br>2.0        | (4)<br>2.0           | (5)<br>2.0.1.3 | (6)<br>3.3         | (7a)<br>3.4                              | (7b)<br>3.5         | (8)<br>4.1.4 | (9)<br>4.1.4 | (10)<br>4.1.4 | (11)<br>4.1.4 |
| 1764   | DICHLOROACETIC ACID                          | 8                 | –                    | II             | –                  | 1 L                                      | E2                  | P001         | –            | IBC02         | B20           |
| 1765   | DICHLOROACETYL CHLORIDE                      | 8                 | –                    | II             | –                  | 1 L                                      | E2                  | P001         | –            | IBC02         | –             |
| 1766   | DICHLOROPHENYL-TRICHLOROSILANE               | 8                 | –<br>P               | II             | –                  | 0  | E0                  | P010         | –            | –             | –             |
| 1767   | DIETHYLDICHLOROSILANE                        | 8                 | 3                    | II             | –                  | 0  | E0                  | P010         | –            | –             | –             |
| 1768   | DIFLUOROPHOSPHORIC ACID, ANHYDROUS           | 8                 | –                    | II             | –                  | 1 L                                      | E2                  | P001         | –            | IBC02         | B20           |
| 1769   | DIPHENYLDICHLOROSILANE                       | 8                 | –                    | II             | –                  | 0  | E0                  | P010         | –            | –             | –             |
| 1770   | DIPHENYLMETHYL BROMIDE                       | 8                 | –                    | II             | –                  | 1 kg                                     | E2                  | P002         | –            | IBC08         | B4<br>B21     |
| 1771   | DODECYLTRICHLOROSILANE                       | 8                 | –                    | II             | –                  | 0  | E0                  | P010         | –            | –             | –             |
| 1773   | FERRIC CHLORIDE, ANHYDROUS                   | 8                 | –                    | III            | –                  | 5 kg                                     | E1                  | P002<br>LP02 | –            | IBC08         | B3            |
| 1774   | FIRE EXTINGUISHER CHARGES, corrosive liquid  | 8                 | –                    | II             | –                  | 1 L                                      | E0                  | P001         | PP4          | –             | –             |
| 1775   | FLUOROBORIC ACID                             | 8                 | –                    | II             | –                  | 1 L                                      | E2                  | P001         | –            | IBC02         | –             |
| 1776   | FLUOROPHOSPHORIC ACID, ANHYDROUS             | 8                 | –                    | II             | –                  | 1 L                                      | E2                  | P001         | –            | IBC02         | B20           |
| 1777   | FLUOROSULPHONIC ACID                         | 8                 | –                    | I              | –                  | 0  | E0                  | P001         | –            | –             | –             |
| 1778   | FLUOROSILICIC ACID                           | 8                 | –                    | II             | –                  | 1 L                                      | E2                  | P001         | –            | IBC02         | B20           |
| 1779   | FORMIC ACID with more than 85% acid, by mass | 8                 | 3                    | II             | –                  | 1 L                                      | E2                  | P001         | –            | IBC02         | –             |

| UN No. | Portable tanks and bulk containers |                    | EmS                    | Stowage and handling    | Segregation          | Properties and observations   | UN No. |
|--------|------------------------------------|--------------------|------------------------|-------------------------|----------------------|---|--------|
|        | Tank instructions                  | Provisions         |                        |                         |                      |   |        |
| (12)   | (13)<br>4.2.5<br>4.3               | (14)<br>4.2.5      | (15)<br>5.4.3.4<br>7.8 | (16a)<br>7.1<br>7.3–7.7 | (16b)<br>7.2–7.7     | (17)  | (18)   |
| –      | T8                                 | TP2                | F-A, S-B               | Category A              | SGG1<br>SG36<br>SG49 | Colourless liquid. Melting point: –4°C. Highly corrosive to most metals. Causes burns to skin, eyes and mucous membranes.   | 1764   |
| –      | T7                                 | TP2                | F-A, S-B               | Category D<br>SW2       | SGG1<br>SG36<br>SG49 | Colourless liquid with an extremely irritating odour, causing tears. Reacts violently with water, evolving hydrogen chloride, an irritating and corrosive gas apparent as white fumes. In the presence of moisture, highly corrosive to most metals. Causes burns to skin, eyes and mucous membranes.                                     | 1765   |
| –      | T10                                | TP2<br>TP7<br>TP13 | F-A, S-B               | Category C<br>SW2       | SGG1<br>SG36<br>SG49 | Colourless liquid with a pungent odour. Reacts violently with water, evolving hydrogen chloride, an irritating and corrosive gas apparent as white fumes. When involved in a fire, evolves toxic gases. In the presence of moisture, highly corrosive to most metals. Irritating to skin, eyes and mucous membranes.                      | 1766   |
| –      | T10                                | TP2<br>TP7<br>TP13 | F-E, S-C               | Category C<br>SW2       | SGG1<br>SG36<br>SG49 | Colourless, flammable liquid with a pungent odour. Flashpoint: 25°C c.c. Reacts violently with water, evolving hydrogen chloride, an irritating and corrosive gas apparent as white fumes. When involved in a fire, evolves toxic gases. In the presence of moisture, highly corrosive to most metals. Vapour irritates mucous membranes. | 1767   |
| –      | T8                                 | TP2                | F-A, S-B               | Category A<br>SW2       | SGG1<br>SG36<br>SG49 | Colourless liquid. In the presence of moisture, highly corrosive to glass and other siliceous materials. Harmful if swallowed.  | 1768   |
| –      | T10                                | TP2<br>TP7<br>TP13 | F-A, S-B               | Category C<br>SW2       | SGG1<br>SG36<br>SG49 | Colourless liquid with a pungent odour. Reacts violently with water, evolving hydrogen chloride, an irritating and corrosive gas apparent as white fumes. When involved in a fire, evolves toxic gases. In the presence of moisture, highly corrosive to most metals. Vapour irritates mucous membranes.                                  | 1769   |
| –      | T3                                 | TP33               | F-A, S-B               | Category D<br>SW2       | SGG1<br>SG36<br>SG49 | Solid with an irritating odour. Causes tears. Melting point: 45°C. In the presence of moisture, corrosive to most metals. Vapour irritates mucous membranes.  | 1770   |
| –      | T10                                | TP2<br>TP7<br>TP13 | F-A, S-B               | Category C<br>SW2       | SGG1<br>SG36<br>SG49 | Colourless liquid with a pungent odour. Reacts violently with water, evolving hydrogen chloride, an irritating and corrosive gas apparent as white fumes. When involved in a fire, evolves toxic gases. In the presence of moisture, highly corrosive to most metals. Causes burns to skin, eyes and mucous membranes.                    | 1771   |
| –      | T1                                 | TP33               | F-A, S-B               | Category A              | SGG1<br>SG36<br>SG49 | Brown solid. In the presence of moisture, highly corrosive to most metals. The provisions of this Code should not apply to the solid hydrated form.   | 1773   |
| –      | –                                  | –                  | F-A, S-B               | Category A              | –                    | Usually, diluted sulphuric acid in small glass receptacles.   | 1774   |
| –      | T7                                 | TP2                | F-A, S-B               | Category A              | SGG1<br>SG36<br>SG49 | Colourless, clear liquid. Corrosive to most metals. May cause severe burns to skin, eyes and mucous membranes if containing free hydrofluoric acid.   | 1775   |
| –      | T8                                 | TP2                | F-A, S-B               | Category A              | SGG1<br>SG36<br>SG49 | Colourless liquid. In the presence of moisture, highly corrosive to glass, other siliceous materials and most metals. Causes burns to skin, eyes and mucous membranes.  | 1776   |
| –      | T10                                | TP2                | F-A, S-B               | Category D<br>SW2       | SGG1<br>SG36<br>SG49 | Colourless liquid with a pungent odour. Reacts violently with water, evolving hydrogen fluoride, an extremely irritating and corrosive gas apparent as white fumes. In the presence of moisture, highly corrosive to glass, other siliceous materials and most metals. Causes severe burns to skin, eyes and mucous membranes.            | 1777   |
| –      | T8                                 | TP2                | F-A, S-B               | Category A              | SGG1<br>SG36<br>SG49 | Colourless liquid. Highly corrosive to most metals. May cause severe burns to skin, eyes and mucous membranes if containing free hydrofluoric acid.   | 1778   |
| –      | T7                                 | TP2                | F-E, S-C               | Category A<br>SW2       | SGG1<br>SG36<br>SG49 | Colourless flammable liquid with a pungent odour. Pure FORMIC ACID: flashpoint 42°C c.c. Corrosive to most metals. Causes burns to skin, eyes and mucous membranes.   | 1779   |

Part 3 – Dangerous Goods List, special provisions and exceptions

Chapter 3.2 – Dangerous Goods List

| UN No. | Proper shipping name (PSN)                                  | Class or division | Subsidiary hazard(s) | Packing group  | Special provisions | Limited and excepted quantity provisions |                     | Packing      |              | IBC           |               |
|--------|---|-------------------|----------------------|----------------|--------------------|--|---------------------|--------------|--------------|---------------|---------------|
|        |   |                   |                      |                |                    | Limited quantities                       | Excepted quantities | Instructions | Provisions   | Instructions  | Provisions    |
| (1)    | (2)<br>3.1.2  | (3)<br>2.0        | (4)<br>2.0           | (5)<br>2.0.1.3 | (6)<br>3.3         | (7a)<br>3.4                              | (7b)<br>3.5         | (8)<br>4.1.4 | (9)<br>4.1.4 | (10)<br>4.1.4 | (11)<br>4.1.4 |
| 1780   | FUMARYL CHLORIDE  | 8                 | –                    | II             | –                  | 1 L                                      | E2                  | P001         | –            | IBC02         | –             |
| 1781   | HEXADECYLTRICHLOROSILANE                                    | 8                 | –                    | II             | –                  | 0  | E0                  | P010         | –            | –             | –             |
| 1782   | HEXAFLUOROPHOSPHORIC ACID                                   | 8                 | –                    | II             | –                  | 1 L                                      | E2                  | P001         | –            | IBC02         | B20           |
| 1783   | HEXAMETHYLENEDIAMINE SOLUTION                               | 8                 | –                    | II             | –                  | 1 L                                      | E2                  | P001         | –            | IBC02         | –             |
| 1783   | HEXAMETHYLENEDIAMINE SOLUTION                               | 8                 | –                    | III            | 223                | 5 L                                      | E1                  | P001<br>LP01 | –            | IBC03         | –             |
| 1784   | HEXYLTRICHLOROSILANE  | 8                 | –                    | II             | –                  | 0  | E0                  | P010         | –            | –             | –             |
| 1786   | HYDROFLUORIC ACID AND SULPHURIC ACID MIXTURE                | 8                 | 6.1                  | I              | –                  | 0  | E0                  | P001         | –            | –             | –             |
| 1787   | HYDRIODIC ACID  | 8                 | –                    | II             | –                  | 1 L                                      | E2                  | P001         | –            | IBC02         | –             |
| 1787   | HYDRIODIC ACID  | 8                 | –                    | III            | 223                | 5 L                                      | E1                  | P001<br>LP01 | –            | IBC03         | –             |
| 1788   | HYDROBROMIC ACID  | 8                 | –                    | II             | –                  | 1 L                                      | E2                  | P001         | –            | IBC02         | –             |
| 1788   | HYDROBROMIC ACID  | 8                 | –                    | III            | 223                | 5 L                                      | E1                  | P001<br>LP01 | –            | IBC03         | –             |
| 1789   | HYDROCHLORIC ACID   | 8                 | –                    | II             | –                  | 1 L                                      | E2                  | P001         | –            | IBC02         | B20           |
| 1789   | HYDROCHLORIC ACID   | 8                 | –                    | III            | 223                | 5 L                                      | E1                  | P001<br>LP01 | –            | IBC03         | –             |
| 1790   | HYDROFLUORIC ACID, with more than 60% hydrogen fluoride     | 8                 | 6.1                  | I              | –                  | 0  | E0                  | P802         | PP79<br>PP81 | –             | –             |
| 1790   | HYDROFLUORIC ACID, with not more than 60% hydrogen fluoride | 8                 | 6.1                  | II             | –                  | 1 L                                      | E2                  | P001         | PP81         | IBC02         | B20           |
| 1791   | HYPOCHLORITE SOLUTION                                       | 8                 | –<br>P               | II             | 274<br>900         | 1 L                                      | E2                  | P001         | PP10         | IBC02         | B5            |

| UN No. | Portable tanks and bulk containers |                    | EmS                    | Stowage and handling           | Segregation          | Properties and observations  | UN No. |
|--------|------------------------------------|--------------------|------------------------|--------------------------------|----------------------|--|--------|
|        | Tank instructions                  | Provisions         |                        |                                |                      |  |        |
| (12)   | (13)<br>4.2.5<br>4.3               | (14)<br>4.2.5      | (15)<br>5.4.3.4<br>7.8 | (16a)<br>7.1<br>7.3–7.7        | (16b)<br>7.2–7.7     | (17)   | (18)   |
| –      | T7                                 | TP2                | F-A, S-B               | Category C<br>SW2              | SGG1<br>SG36<br>SG49 | Yellow liquid. Reacts violently with water, evolving hydrogen chloride, an irritating and corrosive gas apparent as white fumes. In the presence of moisture, highly corrosive to most metals. Causes burns to skin, eyes and mucous membranes.  | 1780   |
| –      | T10                                | TP2<br>TP7<br>TP13 | F-A, S-B               | Category C<br>SW2              | SGG1<br>SG36<br>SG49 | Colourless liquid with a pungent odour. Reacts violently with water, evolving hydrogen chloride, an irritating and corrosive gas apparent as white fumes. When involved in a fire, evolves toxic gases. In the presence of moisture, highly corrosive to most metals. Vapour irritates mucous membranes.   | 1781   |
| –      | T8                                 | TP2                | F-A, S-B               | Category A                     | SGG1<br>SG36<br>SG49 | Colourless liquid. In the presence of moisture, highly corrosive to glass, other siliceous materials and most metals. Causes burns to skin, eyes and mucous membranes. Harmful if swallowed.   | 1782   |
| –      | T7                                 | TP2                | F-A, S-B               | Category A                     | SG35                 | Colourless liquid. Causes burns to skin, eyes and mucous membranes.  | 1783   |
| –      | T4                                 | TP1                | F-A, S-B               | Category A                     | SG35                 | See entry above.   | 1783   |
| –      | T10                                | TP2<br>TP7<br>TP13 | F-A, S-B               | Category C<br>SW2              | SGG1<br>SG36<br>SG49 | Colourless liquid with a pungent odour. Reacts violently with water, evolving hydrogen chloride, an irritating and corrosive gas apparent as white fumes. When involved in a fire, evolves toxic gases. In the presence of moisture, highly corrosive to most metals. Causes burns to skin, eyes and mucous membranes.   | 1784   |
| –      | T10                                | TP2<br>TP13        | F-A, S-B               | Category D<br>SW2              | SGG1<br>SG36<br>SG49 | Colourless syrupy liquid with a pungent odour. Mixture consists of between 70% and 80% by mass of acids and contains not less than 25% by mass of hydrofluoric acid. Reacts violently with water, developing heat. Highly corrosive to glass, other siliceous materials and most metals. Toxic if swallowed, by skin contact or by inhalation. Causes severe burns to skin and mucous membranes. | 1786   |
| –      | T7                                 | TP2                | F-A, S-B               | Category C                     | SGG1<br>SG36<br>SG49 | Colourless liquid. An aqueous solution of the gas hydrogen iodide. Highly corrosive to most metals. Causes burns to skin, eyes and mucous membranes.   | 1787   |
| –      | T4                                 | TP1                | F-A, S-B               | Category C                     | SGG1<br>SG36<br>SG49 | See entry above.   | 1787   |
| –      | T7                                 | TP2                | F-A, S-B               | Category C                     | SGG1<br>SG36<br>SG49 | Colourless liquid. An aqueous solution of the gas hydrogen bromide. Highly corrosive to most metals. Causes burns to skin, eyes and mucous membranes.  | 1788   |
| –      | T4                                 | TP1                | F-A, S-B               | Category C                     | SGG1<br>SG36<br>SG49 | See entry above.   | 1788   |
| –      | T8                                 | TP2                | F-A, S-B               | Category C                     | SGG1<br>SG36<br>SG49 | Colourless liquid. An aqueous solution of the gas hydrogen chloride. Highly corrosive to most metals. Causes burns to skin, eyes and mucous membranes.   | 1789   |
| –      | T4                                 | TP1                | F-A, S-B               | Category C                     | SGG1<br>SG36<br>SG49 | See entry above.   | 1789   |
| –      | T10                                | TP2<br>TP13        | F-A, S-B               | Category D<br>SW1<br>SW2<br>H2 | SGG1<br>SG36<br>SG49 | Colourless liquid with an irritating odour. Highly corrosive to glass, other siliceous materials and most metals. Toxic if swallowed, by skin contact or by inhalation. Both the liquid and its fumes cause severe burns to skin, eyes and mucous membranes.   | 1790   |
| –      | T8                                 | TP2                | F-A, S-B               | Category D<br>SW1<br>SW2<br>H2 | SGG1<br>SG36<br>SG49 | See entry above.   | 1790   |
| –      | T7                                 | TP2<br>TP24        | F-A, S-B               | Category B                     | SGG8<br>SG20         | Liquid with chlorine odour. In contact with acids, evolves very irritating and corrosive gases. Mildly corrosive to most metals. Causes burns to skin, eyes and mucous membranes.  | 1791   |



Part 3 – Dangerous Goods List, special provisions and exceptions

Chapter 3.2 – Dangerous Goods List

| UN No. | Proper shipping name (PSN)                                | Class or division | Subsidiary hazard(s) | Packing group  | Special provisions | Limited and excepted quantity provisions |                     | Packing      |              | IBC           |               |
|--------|---|-------------------|----------------------|----------------|--------------------|--|---------------------|--------------|--------------|---------------|---------------|
|        |   |                   |                      |                |                    | Limited quantities                       | Excepted quantities | Instructions | Provisions   | Instructions  | Provisions    |
| (1)    | (2)<br>3.1.2  | (3)<br>2.0        | (4)<br>2.0           | (5)<br>2.0.1.3 | (6)<br>3.3         | (7a)<br>3.4                              | (7b)<br>3.5         | (8)<br>4.1.4 | (9)<br>4.1.4 | (10)<br>4.1.4 | (11)<br>4.1.4 |
| 1791   | HYPOCHLORITE SOLUTION                                     | 8                 | –<br>P               | III            | 223<br>274<br>900  | 5 L                                      | E1                  | P001<br>LP01 | –            | IBC03         | –             |
| 1792   | IODINE MONOCHLORIDE, SOLID                                | 8                 | –                    | II             | –                  | 1 kg                                     | E0                  | P002         | –            | IBC08         | B4<br>B21     |
| 1793   | ISOPROPYL ACID PHOSPHATE                                  | 8                 | –                    | III            | –                  | 5 L                                      | E1                  | P001<br>LP01 | –            | IBC02         | –             |
| 1794   | LEAD SULPHATE with more than 3% free acid                 | 8                 | –                    | II             | –                  | 1 kg                                     | E2                  | P002         | –            | IBC08         | B4<br>B21     |
| 1796   | NITRATING ACID MIXTURE with more than 50% nitric acid     | 8                 | 5.1                  | I              | –                  | 0  | E0                  | P001         | –            | –             | –             |
| 1796   | NITRATING ACID MIXTURE with not more than 50% nitric acid | 8                 | –                    | II             | –                  | 1 L                                      | E0                  | P001         | –            | IBC02         | B20           |
| 1798   | NITROHYDROCHLORIC ACID                                    | 8                 | –                    | I              | –                  | 0  | E0                  | P802         | –            | –             | –             |
| 1799   | NONYLTRICHLOROSILANE                                      | 8                 | –                    | II             | –                  | 0  | E0                  | P010         | –            | –             | –             |
| 1800   | OCTADECYLTRICHLORO-SILANE                                 | 8                 | –                    | II             | –                  | 0  | E0                  | P010         | –            | –             | –             |
| 1801   | OCTYLTRICHLOROSILANE                                      | 8                 | –                    | II             | –                  | 0  | E0                  | P010         | –            | –             | –             |
| 1802   | PERCHLORIC ACID with not more than 50% acid, by mass      | 8                 | 5.1                  | II             | –                  | 1 L                                      | E0                  | P001         | –            | IBC02         | –             |
| 1803   | PHENOLSULPHONIC ACID, LIQUID                              | 8                 | –                    | II             | –                  | 1 L                                      | E2                  | P001         | –            | IBC02         | –             |

| UN No. | Portable tanks and bulk containers |                    | EmS                    | Stowage and handling    | Segregation   | Properties and observations   | UN No. |
|--------|------------------------------------|--------------------|------------------------|-------------------------|---|---|--------|
|        | Tank instructions                  | Provisions         |                        |                         |   |   |        |
| (12)   | (13)<br>4.2.5<br>4.3               | (14)<br>4.2.5      | (15)<br>5.4.3.4<br>7.8 | (16a)<br>7.1<br>7.3–7.7 | (16b)<br>7.2–7.7                                    | (17)  | (18)   |
| –      | T4                                 | TP2<br>TP24        | F-A, S-B               | Category B              | SGG8<br>SG20  | Liquid with chlorine odour. In contact with acids, evolves very irritating and corrosive gases. Mildly corrosive to most metals. Causes burns to skin, eyes and mucous membranes.   | 1791   |
| –      | T7                                 | TP2                | F-A, S-B               | Category D<br>SW2       | SGG1<br>SG6<br>SG16<br>SG17<br>SG19<br>SG36<br>SG49 | Red, brown or black crystals. Reacts violently with water, evolving irritating and corrosive gases apparent as white fumes. Powerful oxidant; may cause fire in contact with organic materials such as wood, cotton or straw. In the presence of moisture, highly corrosive to most metals. Vapour irritates mucous membranes.          | 1792   |
| –      | T4                                 | TP1                | F-A, S-B               | Category A              | SGG1<br>SG36<br>SG49                                | Oily liquid. Mildly corrosive to most metals.   | 1793   |
| –      | T3                                 | TP33               | F-A, S-B               | Category A              | SGG1<br>SGG7<br>SGG9<br>SG36<br>SG49                | May be dry solid or slurry. Corrosive to most metals. Harmful if swallowed.   | 1794   |
| –      | T10                                | TP2<br>TP13        | F-A, S-Q               | Category D<br>SW2       | SGG1<br>SG16<br>SG36<br>SG49                        | Mixture of concentrated nitric and sulphuric acids. Oxidant; may cause fire in contact with organic materials such as wood, cotton or straw, developing highly toxic gas (brown fumes). Highly corrosive to most metals. Causes severe burns to skin, eyes and mucous membranes.  | 1796   |
| –      | T8                                 | TP2<br>TP13        | F-A, S-B               | Category D<br>SW2       | SGG1<br>SG36<br>SG49                                | See entry above.  | 1796   |
| –      | T10                                | TP2<br>TP13        | F-A, S-B               | Category D<br>SW2       | SGG1<br>SG6<br>SG16<br>SG17<br>SG19<br>SG36<br>SG49 | Yellow liquid; a mixture of nitric acid and hydrochloric acid, usually in the proportion of 1:3. Powerful oxidant; may cause fire in contact with organic materials such as wood, cotton or straw, evolving suffocating and highly toxic gases. Highly corrosive to all metals. Causes severe burns to skin, eyes and mucous membranes. | 1798   |
| –      | T10                                | TP2<br>TP7<br>TP13 | F-A, S-B               | Category C<br>SW2       | SGG1<br>SG36<br>SG49                                | Colourless liquid with a pungent odour. Reacts violently with water, evolving hydrogen chloride, an irritating and corrosive gas apparent as white fumes. When involved in a fire, evolves toxic gases. In the presence of moisture, highly corrosive to most metals. Causes burns to skin, eyes and mucous membranes.                  | 1799   |
| –      | T10                                | TP2<br>TP7<br>TP13 | F-A, S-B               | Category C<br>SW2       | SGG1<br>SG36<br>SG49                                | Colourless liquid with a pungent odour. Reacts violently with water, evolving hydrogen chloride, an irritating and corrosive gas apparent as white fumes. When involved in a fire, evolves toxic gases. In the presence of moisture, highly corrosive to most metals. Vapour irritates mucous membranes.                                | 1800   |
| –      | T10                                | TP2<br>TP7<br>TP13 | F-A, S-B               | Category C<br>SW2       | SGG1<br>SG36<br>SG49                                | Colourless liquid with a pungent odour. Reacts violently with water, evolving hydrogen chloride, an irritating and corrosive gas apparent as white fumes. When involved in a fire, evolves toxic gases. In the presence of moisture, highly corrosive to most metals. Vapour irritates mucous membranes.                                | 1801   |
| –      | T7                                 | TP2                | F-H, S-Q               | Category C              | SGG1<br>SG16<br>SG36<br>SG49                        | Colourless liquid. Oxidant. Highly corrosive to most metals.  | 1802   |
| –      | T7                                 | TP2                | F-A, S-B               | Category C<br>SW15      | SGG1<br>SG36<br>SG49                                | Yellow, oily liquid. Corrosive to most metals.  | 1803   |

Part 3 – Dangerous Goods List, special provisions and exceptions

Chapter 3.2 – Dangerous Goods List

| UN No. | Proper shipping name (PSN)           | Class or division | Subsidiary hazard(s) | Packing group  | Special provisions | Limited and excepted quantity provisions |                     | Packing      |              | IBC           |               |
|--------|--------------------------------------|-------------------|----------------------|----------------|--------------------|--|---------------------|--------------|--------------|---------------|---------------|
|        |                                      |                   |                      |                |                    | Limited quantities                       | Excepted quantities | Instructions | Provisions   | Instructions  | Provisions    |
| (1)    | (2)<br>3.1.2                         | (3)<br>2.0        | (4)<br>2.0           | (5)<br>2.0.1.3 | (6)<br>3.3         | (7a)<br>3.4                              | (7b)<br>3.5         | (8)<br>4.1.4 | (9)<br>4.1.4 | (10)<br>4.1.4 | (11)<br>4.1.4 |
| 1804   | PHENYLTRICHLOROSILANE                | 8                 | –                    | II             | –                  | 0  | E0                  | P010         | –            | –             | –             |
| 1805   | PHOSPHORIC ACID, SOLUTION            | 8                 | –                    | III            | 223                | 5 L                                      | E1                  | P001<br>LP01 | –            | IBC03         | –             |
| 1806   | PHOSPHORUS PENTACHLORIDE             | 8                 | –                    | II             | –                  | 1 kg                                     | E0                  | P002         | –            | IBC08         | B4<br>B21     |
| 1807   | PHOSPHORUS PENTOXIDE                 | 8                 | –                    | II             | –                  | 1 kg                                     | E2                  | P002         | –            | IBC08         | B4<br>B21     |
| 1808   | PHOSPHORUS TRIBROMIDE                | 8                 | –                    | II             | –                  | 1 L                                      | E0                  | P001         | –            | IBC02         | –             |
| 1809   | PHOSPHORUS TRICHLORIDE               | 6.1               | 8                    | I              | 354                | 0  | E0                  | P602         | –            | –             | –             |
| 1810   | PHOSPHORUS OXYCHLORIDE               | 6.1               | 8                    | I              | 354                | 0  | E0                  | P602         | –            | –             | –             |
| 1811   | POTASSIUM HYDROGEN DIFLUORIDE, SOLID | 8                 | 6.1                  | II             | –                  | 1 kg                                     | E2                  | P002         | –            | IBC08         | B4<br>B21     |
| 1812   | POTASSIUM FLUORIDE, SOLID            | 6.1               | –                    | III            | –                  | 5 kg                                     | E1                  | P002<br>LP02 | –            | IBC08         | B3            |
| 1813   | POTASSIUM HYDROXIDE, SOLID           | 8                 | –                    | II             | –                  | 1 kg                                     | E2                  | P002         | –            | IBC08         | B4<br>B21     |
| 1814   | POTASSIUM HYDROXIDE SOLUTION         | 8                 | –                    | II             | –                  | 1 L                                      | E2                  | P001         | –            | IBC02         | –             |
| 1814   | POTASSIUM HYDROXIDE SOLUTION         | 8                 | –                    | III            | 223                | 5 L                                      | E1                  | P001<br>LP01 | –            | IBC03         | –             |
| 1815   | PROPIONYL CHLORIDE                   | 3                 | 8                    | II             | –                  | 1 L                                      | E2                  | P001         | –            | IBC02         | –             |

| UN No. | Portable tanks and bulk containers |                    | EmS                    | Stowage and handling     | Segregation  | Properties and observations  | UN No. |
|--------|------------------------------------|--------------------|------------------------|--------------------------|--|--|--------|
|        | Tank instructions                  | Provisions         |                        |                          |  |  |        |
| (12)   | (13)<br>4.2.5<br>4.3               | (14)<br>4.2.5      | (15)<br>5.4.3.4<br>7.8 | (16a)<br>7.1<br>7.3–7.7  | (16b)<br>7.2–7.7                                   | (17)   | (18)   |
| –      | T10                                | TP2<br>TP7<br>TP13 | F-A, S-B               | Category C<br>SW2        | SGG1<br>SG36<br>SG49                               | Colourless liquid with a pungent odour. Reacts violently with water, evolving hydrogen chloride, an irritating and corrosive gas apparent as white fumes. When involved in a fire, evolves toxic gases. In the presence of moisture, highly corrosive to most metals. Vapour irritates mucous membranes.   | 1804   |
| –      | T4                                 | TP1                | F-A, S-B               | Category A               | SGG1<br>SG36<br>SG49                               | Miscible in water. Mildly corrosive to most metals.  | 1805   |
| –      | T3                                 | TP33               | F-A, S-B               | Category C<br>SW2        | SGG1<br>SG6<br>SG8<br>SG10<br>SG12<br>SG36<br>SG49 | Colourless, crystalline powder. Reacts violently with water, evolving hydrogen chloride, an irritating and corrosive gas apparent as white fumes. Powerful oxidant; may cause fire in contact with organic materials such as wood, cotton or straw. In the presence of moisture, highly corrosive to most metals.  | 1806   |
| –      | T3                                 | TP33               | F-A, S-B               | Category A               | SGG1<br>SG36<br>SG49                               | Crystalline powder, very deliquescent. Reacts violently with water and organic materials such as wood, cotton or straw, generating heat. In the presence of moisture, mildly corrosive to most metals.   | 1807   |
| –      | T7                                 | TP2                | F-A, S-B               | Category C<br>SW2        | SGG1<br>SG36<br>SG49                               | Colourless liquid with a pungent odour. Reacts violently with water, evolving hydrogen bromide, an irritating and corrosive gas apparent as white fumes. In the presence of moisture, highly corrosive to most metals. Causes burns to skin, eyes and mucous membranes.  | 1808   |
| –      | T20                                | TP2<br>TP13        | F-A, S-B               | Category D<br>SW2        | SGG1<br>SG36<br>SG49                               | Colourless liquid with a pungent odour. Reacts violently with water, evolving hydrogen chloride, an irritating and corrosive gas apparent as white fumes. In the presence of moisture, highly corrosive to most metals. Highly toxic if swallowed, by skin contact or by inhalation. Causes burns to skin, eyes and mucous membranes.                                | 1809   |
| –      | T20                                | TP2<br>TP13        | F-A, S-B               | Category D<br>SW2        | SGG1<br>SG36<br>SG49                               | Colourless liquid with a pungent odour. Reacts violently with water, evolving hydrogen chloride, an irritating and corrosive gas apparent as white fumes. In the presence of moisture, highly corrosive to most metals. Causes burns to skin, eyes and mucous membranes. Highly toxic if swallowed, by skin contact or by inhalation.                                | 1810   |
| –      | T3                                 | TP33               | F-A, S-B               | Category A<br>SW1<br>SW2 | SGG1<br>SG35<br>SG36<br>SG49                       | White crystalline solid. Decomposed by heat or acids, evolving hydrogen fluoride, a toxic, extremely irritating and corrosive gas apparent as white fumes. In the presence of moisture, highly corrosive to glass, other siliceous materials and most metals. Toxic if swallowed, by skin contact or by inhalation. Causes burns to skin, eyes and mucous membranes. | 1811   |
| –      | T1                                 | TP33               | F-A, S-A               | Category A               | SG35   | White, deliquescent crystals or powder. Decomposed by acids, evolving hydrogen fluoride, an irritating and corrosive gas. Toxic if swallowed, by skin contact or by inhalation.  | 1812   |
| –      | T3                                 | TP33               | F-A, S-B               | Category A               | SGG18<br>SG35                                      | White pellets, flakes, lumps or solid blocks, deliquescent. Reacts with ammonium salts, evolving ammonia gas. In the presence of moisture, corrosive to aluminium, zinc and tin. Causes burns to skin, eyes and mucous membranes. Reacts violently with acids.   | 1813   |
| –      | T7                                 | TP2                | F-A, S-B               | Category A               | SGG18<br>SG35                                      | Colourless liquid. Reacts with ammonium salts, evolving ammonia gas. Corrosive to aluminium, zinc and tin. Causes burns to skin, eyes and mucous membranes. Reacts violently with acids.   | 1814   |
| –      | T4                                 | TP1                | F-A, S-B               | Category A               | SGG18<br>SG35                                      | See entry above.   | 1814   |
| –      | T7                                 | TP1                | F-E, S-C               | Category B<br>SW2        | SGG1<br>SG36<br>SG49                               | Colourless liquid. Flashpoint: 12°C c.c. Reacts violently with water, evolving hydrogen chloride, an irritating and corrosive gas, apparent as white fumes. In the presence of moisture, highly corrosive to most metals. Causes burns to skin, eyes and mucous membranes.   | 1815   |

Part 3 – Dangerous Goods List, special provisions and exceptions

Chapter 3.2 – Dangerous Goods List

| UN No. | Proper shipping name (PSN)  | Class or division | Subsidiary hazard(s) | Packing group  | Special provisions | Limited and excepted quantity provisions |                     | Packing      |              | IBC           |               |
|--------|---|-------------------|----------------------|----------------|--------------------|--|---------------------|--------------|--------------|---------------|---------------|
|        |   |                   |                      |                |                    | Limited quantities                       | Excepted quantities | Instructions | Provisions   | Instructions  | Provisions    |
| (1)    | (2)<br>3.1.2  | (3)<br>2.0        | (4)<br>2.0           | (5)<br>2.0.1.3 | (6)<br>3.3         | (7a)<br>3.4                              | (7b)<br>3.5         | (8)<br>4.1.4 | (9)<br>4.1.4 | (10)<br>4.1.4 | (11)<br>4.1.4 |
| 1816   | PROPYLTRICHLOROSILANE   | 8                 | 3                    | II             | –                  | 0  | E0                  | P010         | –            | –             | –             |
| 1817   | PYROSULPHURYL CHLORIDE  | 8                 | –                    | II             | –                  | 1 L                                      | E2                  | P001         | –            | IBC02         | –             |
| 1818   | SILICON TETRACHLORIDE   | 8                 | –                    | II             | –                  | 0  | E0                  | P010         | –            | –             | –             |
| 1819   | SODIUM ALUMINATE SOLUTION   | 8                 | –                    | II             | –                  | 1 L                                      | E2                  | P001         | –            | IBC02         | –             |
| 1819   | SODIUM ALUMINATE SOLUTION   | 8                 | –                    | III            | 223                | 5 L                                      | E1                  | P001<br>LP01 | –            | IBC03         | –             |
| 1823   | SODIUM HYDROXIDE, SOLID   | 8                 | –                    | II             | –                  | 1 kg                                     | E2                  | P002         | –            | IBC08         | B4<br>B21     |
| 1824   | SODIUM HYDROXIDE SOLUTION   | 8                 | –                    | II             | –                  | 1 L                                      | E2                  | P001         | –            | IBC02         | –             |
| 1824   | SODIUM HYDROXIDE SOLUTION   | 8                 | –                    | III            | 223                | 5 L                                      | E1                  | P001<br>LP01 | –            | IBC03         | –             |
| 1825   | SODIUM MONOXIDE   | 8                 | –                    | II             | –                  | 1 kg                                     | E2                  | P002         | –            | IBC08         | B4<br>B21     |
| 1826   | NITRATING ACID MIXTURE, SPENT, with more than 50% nitric acid     | 8                 | 5.1                  | I              | 113                | 0  | E0                  | P001         | –            | –             | –             |
| 1826   | NITRATING ACID MIXTURE, SPENT, with not more than 50% nitric acid | 8                 | –                    | II             | 113                | 1 L                                      | E0                  | P001         | –            | IBC02         | B20           |
| 1827   | STANNIC CHLORIDE, ANHYDROUS                                       | 8                 | –                    | II             | –                  | 1 L                                      | E2                  | P001         | –            | IBC02         | –             |
| 1828   | SULPHUR CHLORIDES   | 8                 | –                    | I              | –                  | 0  | E0                  | P602         | –            | –             | –             |
| 1829   | SULPHUR TRIOXIDE, STABILIZED                                      | 8                 | –                    | I              | 386                | 0  | E0                  | P001         | –            | –             | –             |
| 1830   | SULPHURIC ACID with more than 51% acid                            | 8                 | –                    | II             | –                  | 1 L                                      | E2                  | P001         | –            | IBC02         | B20           |

| UN No. | Portable tanks and bulk containers |                             | EmS                    | Stowage and handling     | Segregation                  | Properties and observations  | UN No. |
|--------|------------------------------------|-----------------------------|------------------------|--------------------------|------------------------------|--|--------|
|        | Tank instructions                  | Provisions                  |                        |                          |                              |  |        |
| (12)   | (13)<br>4.2.5<br>4.3               | (14)<br>4.2.5               | (15)<br>5.4.3.4<br>7.8 | (16a)<br>7.1<br>7.3–7.7  | (16b)<br>7.2–7.7             | (17)   | (18)   |
| –      | T10                                | TP2<br>TP7<br>TP13          | F-E, S-C               | Category C<br>SW2        | SGG1<br>SG36<br>SG49         | Colourless, flammable liquid, with a pungent odour. Flashpoint: 38°C c.c. Reacts violently with water, evolving hydrogen chloride, an irritating and corrosive gas apparent as white fumes. When involved in a fire, evolves toxic gases. In the presence of moisture, highly corrosive to most metals. Vapour irritates mucous membranes. | 1816   |
| –      | T8                                 | TP2                         | F-A, S-B               | Category C<br>SW2        | SGG1<br>SG36<br>SG49         | Colourless liquid with a pungent odour. Reacts violently with water, evolving hydrogen chloride, an irritating and corrosive gas apparent as white fumes. In the presence of moisture, highly corrosive to most metals. Vapour irritates mucous membranes.   | 1817   |
| –      | T10                                | TP2<br>TP7<br>TP13          | F-A, S-B               | Category C<br>SW2        | SGG1<br>SG36<br>SG49<br>SG72 | Colourless, extremely mobile liquid with a suffocating odour. Reacts violently with water, evolving hydrogen chloride, an irritating and corrosive gas apparent as white fumes. In the presence of moisture, highly corrosive to most metals. Vapour irritates mucous membranes.   | 1818   |
| –      | T7                                 | TP2                         | F-A, S-B               | Category A               | SGG18<br>SG35                | Colourless liquid. Reacts with ammonium salts, evolving ammonia gas. Corrosive to aluminium, zinc and tin. Causes burns to skin, eyes and mucous membranes. Reacts violently with acids.   | 1819   |
| –      | T4                                 | TP1                         | F-A, S-B               | Category A               | SGG18<br>SG35                | See entry above.   | 1819   |
| –      | T3                                 | TP33                        | F-A, S-B               | Category A               | SGG18<br>SG35                | White pellets, flakes, lumps or solid blocks, deliquescent. Reacts with ammonium salts, evolving ammonia gas. In the presence of moisture, corrosive to aluminium, zinc and tin. Causes burns to skin, eyes and mucous membranes. Reacts violently with acids.   | 1823   |
| –      | T7                                 | TP2                         | F-A, S-B               | Category A               | SGG18<br>SG35                | Colourless liquid. Corrosive to aluminium, zinc and tin. Reacts with ammonium salts, evolving ammonia gas. Causes burns to skin, eyes and mucous membranes. Reacts violently with acids.   | 1824   |
| –      | T4                                 | TP1                         | F-A, S-B               | Category A               | SGG18<br>SG35                | See entry above.   | 1824   |
| –      | T3                                 | TP33                        | F-A, S-B               | Category A               | SGG18<br>SG35                | Deliquescent crystalline solid. Reacts violently with water and acids, generating heat. Reacts with ammonium salts, evolving ammonia gas. In the presence of moisture, corrosive to aluminium, zinc and tin. Causes burns to skin, eyes and mucous membranes.  | 1825   |
| –      | T10                                | TP2<br>TP13                 | F-A, S-Q               | Category D<br>SW2        | SGG1<br>SG16<br>SG36<br>SG49 | Usually a mixture of acids which has been used for nitration processes. Highly corrosive to most metals. Causes severe burns to skin, eyes and mucous membranes. Prohibited for shipment unless the mixture is (1) chemically stable; and (2) certified as containing no explosive impurities.   | 1826   |
| –      | T8                                 | TP2                         | F-A, S-B               | Category D<br>SW2        | SGG1<br>SG36<br>SG49         | See entry above.   | 1826   |
| –      | T7                                 | TP2                         | F-A, S-B               | Category C               | SGG1<br>SG36<br>SG49         | Colourless liquid. In the presence of water, corrosive to most metals. Vapour irritates mucous membranes.  | 1827   |
| –      | T20                                | TP2                         | F-A, S-B               | Category C<br>SW2        | SGG1<br>SG36<br>SG49         | Red liquids with a suffocating odour. React violently with water, evolving hydrogen chloride and sulphur dioxide, irritating and corrosive gases. In the presence of moisture, highly corrosive to most metals. Causes severe burns to skin, eyes and mucous membranes.  | 1828   |
| –      | T20                                | TP4<br>TP13<br>TP25<br>TP26 | F-A, S-B               | Category C<br>SW1<br>SW2 | SGG1<br>SG36<br>SG49         | Very deliquescent solid. Melting point may be as low as 17°C. Reacts violently with water, generating heat. May cause fire in contact with organic materials such as wood, cotton or straw. In the presence of moisture, highly corrosive to most metals. Causes severe burns to skin, eyes and mucous membranes.                          | 1829   |
| –      | T8                                 | TP2                         | F-A, S-B               | Category C<br>SW15       | SGG1<br>SG36<br>SG49         | Colourless, oily liquid, mixture over 1.41 up to 1.84 relative density. In the presence of moisture, highly corrosive to most metals. Causes burns to skin, eyes and mucous membranes.   | 1830   |



| UN No. | Proper shipping name (PSN)   | Class or division | Subsidiary hazard(s) | Packing group  | Special provisions | Limited and excepted quantity provisions |                     | Packing      |              | IBC           |               |
|--------|--|-------------------|----------------------|----------------|--------------------|--|---------------------|--------------|--------------|---------------|---------------|
|        |  |                   |                      |                |                    | Limited quantities                       | Excepted quantities | Instructions | Provisions   | Instructions  | Provisions    |
| (1)    | (2)<br>3.1.2   | (3)<br>2.0        | (4)<br>2.0           | (5)<br>2.0.1.3 | (6)<br>3.3         | (7a)<br>3.4                              | (7b)<br>3.5         | (8)<br>4.1.4 | (9)<br>4.1.4 | (10)<br>4.1.4 | (11)<br>4.1.4 |
| 1831   | SULPHURIC ACID, FUMING   | 8                 | 6.1                  | I              | –                  | 0  | E0                  | P602         | –            | –             | –             |
| 1832   | SULPHURIC ACID, SPENT  | 8                 | –                    | II             | 113                | 1 L                                      | E0                  | P001         | –            | IBC02         | B20           |
| 1833   | SULPHUROUS ACID  | 8                 | –                    | II             | –                  | 1 L                                      | E2                  | P001         | –            | IBC02         | –             |
| 1834   | SULPHURYL CHLORIDE   | 6.1               | 8                    | I              | 354                | 0  | E0                  | P602         | –            | –             | –             |
| △ 1835 | TETRAMETHYLAMMONIUM HYDROXIDE AQUEOUS SOLUTION with more than 2.5% but less than 25% tetramethylammonium hydroxide | 8                 | 6.1                  | II             | 279<br>408<br>409  | 1 L                                      | E2                  | P001         | –            | IBC02         | –             |
| △ 1835 | TETRAMETHYLAMMONIUM HYDROXIDE AQUEOUS SOLUTION with not more than 2.5% tetramethylammonium hydroxide               | 8                 | –                    | III            | 223<br>408<br>409  | 5 L                                      | E1                  | P001<br>LP01 | –            | IBC03         | –             |
| 1836   | THIONYL CHLORIDE   | 8                 | –                    | I              | –                  | 0  | E0                  | P802         | –            | –             | –             |
| 1837   | THIOPHOSPHORYL CHLORIDE  | 8                 | –                    | II             | –                  | 1 L                                      | E0                  | P001         | –            | IBC02         | –             |
| 1838   | TITANIUM TETRACHLORIDE   | 6.1               | 8                    | I              | 354                | 0  | E0                  | P602         | –            | –             | –             |
| 1839   | TRICHLOROACETIC ACID, SOLID  | 8                 | –                    | II             | –                  | 1 kg                                     | E2                  | P002         | –            | IBC08         | B4<br>B21     |
| 1840   | ZINC CHLORIDE SOLUTION   | 8                 | –<br>P               | III            | 223                | 5 L                                      | E1                  | P001<br>LP01 | –            | IBC03         | –             |
| 1841   | ACETALDEHYDE AMMONIA   | 9                 | –                    | III            | –                  | 5 kg                                     | E1                  | P002<br>LP02 | –            | IBC08         | B3<br>B6      |
| 1843   | AMMONIUM DINITRO- <i>o</i> -CRESOLATE, SOLID   | 6.1               | –<br>P               | II             | –                  | 500 g                                    | E4                  | P002         | –            | IBC08         | B4<br>B21     |

| UN No. | Portable tanks and bulk containers |               | EmS                    | Stowage and handling      | Segregation                          | Properties and observations   | UN No. |
|--------|------------------------------------|---------------|------------------------|---------------------------|--------------------------------------|---|--------|
|        | Tank instructions                  | Provisions    |                        |                           |                                      |   |        |
| (12)   | (13)<br>4.2.5<br>4.3               | (14)<br>4.2.5 | (15)<br>5.4.3.4<br>7.8 | (16a)<br>7.1<br>7.3–7.7   | (16b)<br>7.2–7.7                     | (17)  | (18)   |
| –      | T20                                | TP2<br>TP13   | F-A, S-B               | Category C<br>SW2<br>SW15 | SGG1<br>SG36<br>SG49                 | Colourless, oily liquid, may be partly crystallized. Solution of varying quantities of sulphur trioxide in sulphuric acid. Reacts violently with water and organic material, generating heat. In the presence of moisture, highly corrosive to most metals. Toxic if swallowed, by skin contact or by inhalation. Causes severe burns to skin, eyes and mucous membranes. | 1831   |
| –      | T8                                 | TP2           | F-A, S-B               | Category C<br>SW15        | SGG1<br>SG36<br>SG49                 | Sulphuric acid, usually of high concentration, which has been used for chemical processes. Highly corrosive to most metals.   | 1832   |
| –      | T7                                 | TP2           | F-A, S-B               | Category B<br>SW2         | SGG1<br>SG36<br>SG49                 | Solution of sulphur dioxide in water, with a suffocating odour. Corrosive to most metals. Vapour irritates mucous membranes.  | 1833   |
| –      | T20                                | TP2<br>TP13   | F-A, S-B               | Category D<br>SW2         | SGG1<br>SG36<br>SG49                 | Colourless liquid with a pungent odour. Boiling point: 69°C. Reacts violently with water, evolving hydrogen chloride, an irritating and corrosive gas apparent as white fumes. In the presence of moisture, highly corrosive to most metals. Causes severe burns to skin, eyes and mucous membranes. Highly toxic if swallowed, by skin contact or by inhalation.         | 1834   |
| –      | T7                                 | TP2           | F-A, S-B               | Category A                | SGG2<br>SGG18<br>SG35                | Colourless liquid with a strong ammonia-like odour that is miscible with water. Corrosive to metal. When heated emits toxic fumes of nitrogen oxides and ammonia. Highly toxic if swallowed, by skin contact or by inhalation. Causes burns to skin, eyes, and mucous membranes. Reacts violently with acids.   | 1835 △ |
| –      | T7                                 | TP2           | F-A, S-B               | Category A                | SGG2<br>SGG18<br>SG35                | See entry above.  | 1835 △ |
| –      | T10                                | TP2<br>TP13   | F-A, S-B               | Category C<br>SW2         | SGG1<br>SG36<br>SG49                 | Yellow or red liquid. Boiling point: 79°C. Reacts violently with water, evolving hydrogen chloride and sulphur dioxide, irritating and corrosive gases. In the presence of moisture, highly corrosive to most metals. Causes severe burns to skin, eyes and mucous membranes.   | 1836   |
| –      | T7                                 | TP2           | F-A, S-B               | Category C<br>SW2         | SGG1<br>SG36<br>SG49                 | Colourless liquid with a pungent odour. Reacts violently with water, evolving hydrogen chloride, an irritating and corrosive gas apparent as white fumes. In the presence of moisture, highly corrosive to most metals. Vapour irritates mucous membranes.  | 1837   |
| –      | T20                                | TP2<br>TP13   | F-A, S-B               | Category D<br>SW2         | SGG1<br>SGG7<br>SG36<br>SG49         | Colourless liquid. Reacts violently with water, evolving hydrogen chloride, an irritating and corrosive gas apparent as white fumes. In the presence of moisture, highly corrosive to most metals. Causes burns to skin, eyes and mucous membranes.   | 1838   |
| –      | T3                                 | TP33          | F-A, S-B               | Category A                | SGG1<br>SG36<br>SG49                 | Colourless, deliquescent crystals. Melting point of the pure substance: 58°C. In the presence of moisture, corrosive to most metals. Causes burns to skin, eyes and mucous membranes.   | 1839   |
| –      | T4                                 | TP2           | F-A, S-B               | Category A                | SGG1<br>SGG7<br>SG36<br>SG49         | Colourless liquid. Mildly corrosive to most metals. Causes burns to skin, eyes and mucous membranes.  | 1840   |
| –      | T1                                 | TP33          | F-A, S-B               | Category A                | SG29                                 | White crystalline solid. Soluble in water. When heated, decomposes into ammonia and acetaldehyde.   | 1841   |
| –      | T3                                 | TP33          | F-A, S-A               | Category B                | SGG2<br>SG15<br>SG16<br>SG30<br>SG63 | May support combustion and burn without oxygen. When involved in a fire, evolves toxic fumes. Forms extremely sensitive explosive compounds with lead, silver or other heavy metals and their compounds. Toxic if swallowed, by skin contact or by inhalation.  | 1843   |

Part 3 – Dangerous Goods List, special provisions and exceptions

Chapter 3.2 – Dangerous Goods List

| UN No. | Proper shipping name (PSN)   | Class or division | Subsidiary hazard(s) | Packing group  | Special provisions | Limited and excepted quantity provisions |                     | Packing      |              | IBC           |               |
|--------|--|-------------------|----------------------|----------------|--------------------|--|---------------------|--------------|--------------|---------------|---------------|
|        |  |                   |                      |                |                    | Limited quantities                       | Excepted quantities | Instructions | Provisions   | Instructions  | Provisions    |
| (1)    | (2)<br>3.1.2   | (3)<br>2.0        | (4)<br>2.0           | (5)<br>2.0.1.3 | (6)<br>3.3         | (7a)<br>3.4                              | (7b)<br>3.5         | (8)<br>4.1.4 | (9)<br>4.1.4 | (10)<br>4.1.4 | (11)<br>4.1.4 |
| 1845   | CARBON DIOXIDE, SOLID (DRY ICE)  | 9                 | –                    | –              | –                  | 0  | E0                  | P003         | PP18         | –             | –             |
| 1846   | CARBON TETRACHLORIDE   | 6.1               | –<br>P               | II             | –                  | 100 mL                                   | E4                  | P001         | –            | IBC02         | –             |
| 1847   | POTASSIUM SULPHIDE, HYDRATED with not less than 30% water of crystallization | 8                 | –                    | II             | –                  | 1 kg                                     | E2                  | P002         | –            | IBC08         | B4<br>B21     |
| 1848   | PROPIONIC ACID with not less than 10% and less than 90% acid, by mass        | 8                 | –                    | III            | –                  | 5 L                                      | E1                  | P001<br>LP01 | –            | IBC03         | –             |
| 1849   | SODIUM SULPHIDE, HYDRATED with not less than 30% water                       | 8                 | –                    | II             | –                  | 1 kg                                     | E2                  | P002         | –            | IBC08         | B4<br>B21     |
| 1851   | MEDICINE, LIQUID, TOXIC, N.O.S.  | 6.1               | –                    | II             | 221                | 100 mL                                   | E4                  | P001         | –            | –             | –             |
| 1851   | MEDICINE, LIQUID, TOXIC, N.O.S.  | 6.1               | –                    | III            | 221<br>223         | 5 L                                      | E1                  | P001<br>LP01 | –            | –             | –             |
| 1854   | BARIUM ALLOYS, PYROPHORIC  | 4.2               | –                    | I              | –                  | 0  | E0                  | P404         | PP31         | –             | –             |
| 1855   | CALCIUM, PYROPHORIC or CALCIUM ALLOYS, PYROPHORIC                            | 4.2               | –                    | I              | –                  | 0  | E0                  | P404         | PP31         | –             | –             |
| 1856   | RAGS, OILY   | 4.2               | –                    | –              | 29<br>123<br>973   | 0  | E0                  | P003         | PP19         | IBC08         | B3<br>B6      |
| 1857   | TEXTILE WASTE, WET   | 4.2               | –                    | III            | 123                | 0  | E1                  | P410         | –            | –             | –             |
| 1858   | HEXAFLUOROPROPYLENE (REFRIGERANT GAS R 1216)                                 | 2.2               | –                    | –              | –                  | 120 mL                                   | E1                  | P200         | –            | –             | –             |
| 1859   | SILICON TETRAFLUORIDE  | 2.3               | 8                    | –              | –                  | 0  | E0                  | P200         | –            | –             | –             |
| 1860   | VINYL FLUORIDE, STABILIZED   | 2.1               | –                    | –              | 386                | 0  | E0                  | P200         | –            | –             | –             |
| 1862   | ETHYL CROTONATE  | 3                 | –                    | II             | –                  | 1 L                                      | E2                  | P001         | –            | IBC02         | –             |
| 1863   | FUEL, AVIATION, TURBINE ENGINE   | 3                 | –                    | I              | –                  | 500 mL                                   | E3                  | P001         | –            | –             | –             |
| 1863   | FUEL, AVIATION, TURBINE ENGINE   | 3                 | –                    | II             | –                  | 1 L                                      | E2                  | P001         | –            | IBC02         | –             |
| 1863   | FUEL, AVIATION, TURBINE ENGINE   | 3                 | –                    | III            | 223                | 5 L                                      | E1                  | P001<br>LP01 | –            | IBC03         | –             |
| 1865   | n-PROPYL NITRATE   | 3                 | –                    | II             | 26                 | 1 L                                      | E2                  | P001         | –            | –             | –             |

| UN No. | Portable tanks and bulk containers |                    | EmS                    | Stowage and handling     | Segregation                | Properties and observations   | UN No. |
|--------|------------------------------------|--------------------|------------------------|--------------------------|----------------------------|---|--------|
|        | Tank instructions                  | Provisions         |                        |                          |                            |   |        |
| (12)   | (13)<br>4.2.5<br>4.3               | (14)<br>4.2.5      | (15)<br>5.4.3.4<br>7.8 | (16a)<br>7.1<br>7.3–7.7  | (16b)<br>7.2–7.7           | (17)  | (18)   |
| –      | –                                  | –                  | F-C, S-V               | Category C<br>SW2        | –                          | Non-flammable gas in a white solid form. Slowly evolves vapours which are heavier than air (1.5). Inhalation of vapours may lead to unconsciousness. Can cause severe burns when in contact with the skin.  | 1845   |
| –      | T7                                 | TP2                | F-A, S-A               | Category A<br>SW2        | SGG10                      | Colourless, volatile liquid with a heavy anaesthetic vapour. Non-flammable; when involved in a fire, evolves extremely toxic fumes (phosgene). Toxic if swallowed, by skin contact or by inhalation.  | 1846   |
| –      | T3                                 | TP33               | F-A, S-B               | Category A               | SGG18<br>SG35              | Crystalline solid. Melting point: 60°C. Reacts violently with acids, evolving hydrogen sulphide, a toxic and flammable gas. Mildly corrosive to most metals. Causes burns to skin, eyes and mucous membranes.   | 1847   |
| –      | T4                                 | TP1                | F-A, S-B               | Category A               | SGG1<br>SG36<br>SG49       | Colourless liquid with a pungent odour. Miscible with water. Corrosive to lead and most other metals. Burns skin. Vapours irritate mucous membranes.  | 1848   |
| –      | T3                                 | TP33               | F-A, S-B               | Category A               | SGG18<br>SG35              | Yellow-pink or white deliquescent crystals, flakes or lumps. Melting point: 50°C. Soluble in water. Reacts violently with acids, evolving hydrogen sulphide, a toxic and flammable gas. Mildly corrosive to most metals. Causes burns to skin, eyes and mucous membranes. | 1849   |
| –      | –                                  | –                  | F-A, S-A               | Category C<br>SW2        | –                          | Toxic if swallowed, by skin contact or by inhalation.   | 1851   |
| –      | –                                  | –                  | F-A, S-A               | Category C<br>SW2        | –                          | See entry above.  | 1851   |
| –      | T21                                | TP7<br>TP33        | F-G, S-M               | Category D<br>H1         | SGG15<br>SG26              | Liable to ignite spontaneously in air. If shaken, may produce sparks. In contact with water, evolve hydrogen, a flammable gas.  | 1854   |
| –      | –                                  | –                  | F-G, S-M               | Category D<br>H1         | SG26                       | Liable to ignite spontaneously in air. If shaken, may produce sparks. In contact with water, evolve hydrogen, a flammable gas.  | 1855   |
| –      | –                                  | –                  | F-A, S-J               | Category A               | –                          | Liable to ignite spontaneously in air according to oil content.   | 1856   |
| –      | –                                  | –                  | F-A, S-J               | Category A               | –                          | Liable to ignite spontaneously in air according to moisture content.  | 1857   |
| –      | T50                                | –                  | F-C, S-V               | Category A               | –                          | Non-flammable gas. Much heavier than air (5.2).   | 1858   |
| –      | –                                  | –                  | F-C, S-U               | Category D<br>SW2        | –                          | Non-flammable, toxic and corrosive gas with a pungent odour. Corrosive to metals. In moist air, produces hydrogen fluoride. Much heavier than air (3.6). Highly irritating to skin, eyes and mucous membranes.  | 1859   |
| –      | –                                  | –                  | F-D, S-U               | Category E<br>SW1<br>SW2 | –                          | Flammable gas. Explosive limits: 2.9% to 29%. Heavier than air (1.6).   | 1860   |
| –      | T4                                 | TP2                | F-E, S-D               | Category B               | –                          | Colourless liquid with a pungent odour. Flashpoint: 2°C c.c. Immiscible with water.   | 1862   |
| –      | T11                                | TP1<br>TP8<br>TP28 | F-E, S-E               | Category E               | –                          | Boiling range: –14°C upwards. Immiscible with water.  | 1863   |
| –      | T4                                 | TP1<br>TP8         | F-E, S-E               | Category B               | –                          | Immiscible with water.  | 1863   |
| –      | T2                                 | TP1                | F-E, S-E               | Category A               | –                          | See entry above.  | 1863   |
| –      | –                                  | –                  | F-E, S-D               | Category D               | SG6<br>SG8<br>SG10<br>SG12 | White to straw-coloured liquid with an ether-like odour. Flashpoint: 20°C c.c. Explosive limits: 2% to 100%. Immiscible with water. Oxidizing material. May explode on heating. Harmful if swallowed or by inhalation.  | 1865   |

Part 3 – Dangerous Goods List, special provisions and exceptions

Chapter 3.2 – Dangerous Goods List

| UN No. | Proper shipping name (PSN)   | Class or division | Subsidiary hazard(s) | Packing group  | Special provisions | Limited and excepted quantity provisions |                     | Packing      |              | IBC           |               |
|--------|--|-------------------|----------------------|----------------|--------------------|--|---------------------|--------------|--------------|---------------|---------------|
|        |  |                   |                      |                |                    | Limited quantities                       | Excepted quantities | Instructions | Provisions   | Instructions  | Provisions    |
| (1)    | (2)<br>3.1.2   | (3)<br>2.0        | (4)<br>2.0           | (5)<br>2.0.1.3 | (6)<br>3.3         | (7a)<br>3.4                              | (7b)<br>3.5         | (8)<br>4.1.4 | (9)<br>4.1.4 | (10)<br>4.1.4 | (11)<br>4.1.4 |
| 1866   | RESIN SOLUTION, flammable  | 3                 | –                    | I              | –                  | 500 mL                                   | E3                  | P001         | –            | –             | –             |
| 1866   | RESIN SOLUTION, flammable  | 3                 | –                    | II             | –                  | 5 L                                      | E2                  | P001         | PP1          | IBC02         | –             |
| 1866   | RESIN SOLUTION, flammable  | 3                 | –                    | III            | 223<br>955         | 5 L                                      | E1                  | P001<br>LP01 | PP1          | IBC03         | –             |
| 1868   | DECABORANE   | 4.1               | 6.1                  | II             | –                  | 1 kg                                     | E0                  | P002         | PP31         | IBC06         | B21           |
| 1869   | MAGNESIUM or MAGNESIUM ALLOYS with more than 50% magnesium in pellets, turnings or ribbons | 4.1               | –                    | III            | 59<br>920          | 5 kg                                     | E1                  | P002<br>LP02 | PP100<br>L3  | IBC08         | B4            |
| 1870   | POTASSIUM BOROHYDRIDE  | 4.3               | –                    | I              | –                  | 0  | E0                  | P403         | PP31         | –             | –             |
| 1871   | TITANIUM HYDRIDE   | 4.1               | –                    | II             | –                  | 1 kg                                     | E2                  | P410         | PP31<br>PP40 | IBC04         | –             |
| 1872   | LEAD DIOXIDE   | 5.1               | –                    | III            | –                  | 5 kg                                     | E1                  | P002<br>LP02 | –            | IBC08         | B3            |
| 1873   | PERCHLORIC ACID with more than 50% but not more than 72% acid, by mass                     | 5.1               | 8                    | I              | 900                | 0  | E0                  | P502         | PP28         | –             | –             |
| 1884   | BARIUM OXIDE   | 6.1               | –                    | III            | –                  | 5 kg                                     | E1                  | P002<br>LP02 | –            | IBC08         | B3            |
| 1885   | BENZIDINE  | 6.1               | –                    | II             | –                  | 500 g                                    | E4                  | P002         | –            | IBC08         | B4<br>B21     |
| 1886   | BENZYLIDENE CHLORIDE   | 6.1               | –                    | II             | –                  | 100 mL                                   | E4                  | P001         | –            | IBC02         | –             |
| 1887   | BROMOCHLOROMETHANE   | 6.1               | –                    | III            | –                  | 5 L                                      | E1                  | P001<br>LP01 | –            | IBC03         | –             |
| 1888   | CHLOROFORM   | 6.1               | –                    | III            | –                  | 5 L                                      | E1                  | P001<br>LP01 | –            | IBC03         | –             |
| 1889   | CYANOGEN BROMIDE   | 6.1               | 8<br>P               | I              | –                  | 0  | E0                  | P002         | PP31         | –             | –             |
| 1891   | ETHYL BROMIDE  | 3                 | 6.1                  | II             | –                  | 1 L                                      | E2                  | P001         | –            | IBC02         | B8            |
| 1892   | ETHYLDICHLOROARSINE  | 6.1               | –<br>P               | I              | 354                | 0  | E0                  | P602         | –            | –             | –             |

| UN No. | Portable tanks and bulk containers |                    | EmS                    | Stowage and handling     | Segregation  | Properties and observations   | UN No. |
|--------|------------------------------------|--------------------|------------------------|--------------------------|--|---|--------|
|        | Tank instructions                  | Provisions         |                        |                          |  |   |        |
| (12)   | (13)<br>4.2.5<br>4.3               | (14)<br>4.2.5      | (15)<br>5.4.3.4<br>7.8 | (16a)<br>7.1<br>7.3–7.7  | (16b)<br>7.2–7.7                                     | (17)  | (18)   |
| –      | T11                                | TP1<br>TP8<br>TP28 | F-E, S-E               | Category E               | –  | Miscibility with water depends upon the composition.  | 1866   |
| –      | T4                                 | TP1<br>TP8         | F-E, S-E               | Category B               | –  | See entry above.  | 1866   |
| –      | T2                                 | TP1                | F-E, S-E               | Category A               | –  | See entry above.  | 1866   |
| –      | T3                                 | TP33               | F-A, S-G               | Category A               | SG17   | Colourless crystals. Slightly soluble in water. Vapours may form explosive mixture in air. Forms explosive and extremely sensitive mixtures with oxidizing substances. Toxic if swallowed, by skin contact or by dust inhalation.   | 1868   |
| –      | T1                                 | TP33               | F-G, S-G               | Category A<br>H1         | SG17<br>SG25<br>SG26<br>SG32<br>SG35<br>SG36<br>SG52 | Silvery white metal. Burns with an intense white light and heat. In contact with water, especially seawater, may evolve hydrogen, a flammable gas. Reacts readily with acids and caustic alkali, evolving hydrogen. Reacts readily with iron oxide, producing a thermite effect. Forms explosive mixtures with oxidizing substances.  | 1869   |
| –      | –                                  | –                  | F-G, S-O               | Category E<br>H1         | SG26<br>SG35   | White, crystalline powder. In contact with water, acids or moisture evolves hydrogen, which may be ignited by the heat of the reaction.   | 1870   |
| –      | T3                                 | TP33               | F-A, S-G               | Category E               | –  | Dark grey powder or crystals.   | 1871   |
| –      | T1                                 | TP33               | F-A, S-Q               | Category A               | SGG7<br>SGG9   | Brown powder or crystals. Insoluble in water. Harmful if swallowed.   | 1872   |
| –      | T10                                | TP1                | F-A, S-Q               | Category D               | SGG1<br>SG16<br>SG36<br>SG49                         | Colourless liquid. Mixtures with combustible material may ignite spontaneously and, when involved in a fire, by shock or by friction, may cause an explosion. Highly corrosive to most metals. Causes burns to skin, eyes and mucous membranes. Transport of PERCHLORIC ACID with more than 72% acid, by mass, is prohibited.   | 1873   |
| –      | T1                                 | TP33               | F-A, S-A               | Category A               | –  | White solid. Evolves heat in contact with water. Toxic if swallowed, by skin contact or by dust inhalation.   | 1884   |
| –      | T3                                 | TP33               | F-A, S-A               | Category A               | –  | White, crystalline solid. Toxic if swallowed, by skin contact or by inhalation.   | 1885   |
| –      | T7                                 | TP2                | F-A, S-A               | Category D<br>SW2        | –  | Colourless liquid evolving vapour which is irritating to eyes and skin ("Tear Gas"). Toxic if swallowed, by skin contact or by inhalation.  | 1886   |
| –      | T4                                 | TP1                | F-A, S-A               | Category A               | SGG10  | Clear, colourless, volatile liquid with a chloroform-like odour. Immiscible with water. When involved in a fire, evolves extremely toxic fumes (phosgene). Toxic if swallowed, by skin contact or by inhalation.  | 1887   |
| –      | T7                                 | TP2                | F-A, S-A               | Category A<br>SW2        | SGG10  | Colourless, volatile liquid. Boiling point: 61°C. Non-flammable. When involved in a fire, evolves extremely toxic fumes (phosgene). Toxic if swallowed, by skin contact or by inhalation. Anaesthetic.  | 1888   |
| –      | T6                                 | TP33               | F-A, S-B               | Category D<br>SW2        | SGG6<br>SG35   | Colourless crystals evolving toxic vapour which is irritating and causes tears. Melting point: approximately 52°C. Boiling point: approximately 62°C. In contact with water evolves hydrogen bromide and hydrogen cyanide, which are highly toxic, flammable and corrosive gases. Highly toxic if swallowed, by skin contact or by inhalation. Causes burns to skin, eyes and mucous membranes. | 1889   |
| –      | T7                                 | TP2<br>TP13        | F-E, S-D               | Category B<br>SW2<br>SW5 | SGG10  | Colourless volatile liquid evolving irritating vapour with a narcotic effect. Flashpoint –20°C c.c. Boiling point: 38°C. Vapour can be ignited by an electric spark or similar sources of ignition. Toxic if swallowed, by skin contact or by inhalation.   | 1891   |
| –      | T20                                | TP2<br>TP13        | F-A, S-A               | Category D<br>SW2        | –  | Colourless liquid evolving irritating vapour ("Tear Gas"). Highly toxic if swallowed, by skin contact or by inhalation.   | 1892   |

Part 3 – Dangerous Goods List, special provisions and exceptions

Chapter 3.2 – Dangerous Goods List

| UN No. | Proper shipping name (PSN)                     | Class or division | Subsidiary hazard(s) | Packing group  | Special provisions | Limited and excepted quantity provisions |                     | Packing      |              | IBC           |               |
|--------|--|-------------------|----------------------|----------------|--------------------|--|---------------------|--------------|--------------|---------------|---------------|
|        |  |                   |                      |                |                    | Limited quantities                       | Excepted quantities | Instructions | Provisions   | Instructions  | Provisions    |
| (1)    | (2)<br>3.1.2                                   | (3)<br>2.0        | (4)<br>2.0           | (5)<br>2.0.1.3 | (6)<br>3.3         | (7a)<br>3.4                              | (7b)<br>3.5         | (8)<br>4.1.4 | (9)<br>4.1.4 | (10)<br>4.1.4 | (11)<br>4.1.4 |
| 1894   | PHENYLMERCURIC HYDROXIDE                       | 6.1               | -<br>P               | II             | -                  | 500 g                                    | E4                  | P002         | -            | IBC08         | B4<br>B21     |
| 1895   | PHENYLMERCURIC NITRATE                         | 6.1               | -<br>P               | II             | -                  | 500 g                                    | E4                  | P002         | -            | IBC08         | B4<br>B21     |
| 1897   | TETRACHLOROETHYLENE                            | 6.1               | -<br>P               | III            | -                  | 5 L                                      | E1                  | P001<br>LP01 | -            | IBC03         | -             |
| 1898   | ACETYL IODIDE                                  | 8                 | -                    | II             | -                  | 1 L                                      | E2                  | P001         | -            | IBC02         | -             |
| 1902   | DIISOCTYL ACID PHOSPHATE                       | 8                 | -                    | III            | -                  | 5 L                                      | E1                  | P001<br>LP01 | -            | IBC03         | -             |
| 1903   | DISINFECTANT, LIQUID, CORROSIVE, N.O.S.        | 8                 | -                    | I              | 274                | 0  | E0                  | P001         | -            | -             | -             |
| 1903   | DISINFECTANT, LIQUID, CORROSIVE, N.O.S.        | 8                 | -                    | II             | 274                | 1 L                                      | E2                  | P001         | -            | IBC02         | -             |
| 1903   | DISINFECTANT, LIQUID, CORROSIVE, N.O.S.        | 8                 | -                    | III            | 223<br>274         | 5 L                                      | E1                  | P001<br>LP01 | -            | IBC03         | -             |
| 1905   | SELENIC ACID                                   | 8                 | -                    | I              | -                  | 0  | E0                  | P002         | -            | IBC07         | B1            |
| 1906   | SLUDGE ACID                                    | 8                 | -                    | II             | -                  | 1 L                                      | E0                  | P001         | -            | IBC02         | -             |
| 1907   | SODA LIME with more than 4% sodium hydroxide   | 8                 | -                    | III            | 62                 | 5 kg                                     | E1                  | P002<br>LP02 | -            | IBC08         | B3            |
| 1908   | CHLORITE SOLUTION                              | 8                 | -                    | II             | 274<br>352         | 1 L                                      | E2                  | P001         | -            | IBC02         | -             |
| 1908   | CHLORITE SOLUTION                              | 8                 | -                    | III            | 223<br>274<br>352  | 5 L                                      | E1                  | P001<br>LP01 | -            | IBC03         | -             |
| 1910   | CALCIUM OXIDE                                  | 8                 | -                    | -              | 960                | -  | -                   | -            | -            | -             | -             |
| 1911   | DIBORANE                                       | 2.3               | 2.1                  | -              | -                  | 0  | E0                  | P200         | -            | -             | -             |
| 1912   | METHYL CHLORIDE AND METHYLENE CHLORIDE MIXTURE | 2.1               | -                    | -              | 228                | 0  | E0                  | P200         | -            | -             | -             |
| 1913   | NEON, REFRIGERATED LIQUID                      | 2.2               | -                    | -              | -                  | 120 mL                                   | E1                  | P203         | -            | -             | -             |

| UN No. | Portable tanks and bulk containers |               | EmS                    | Stowage and handling    | Segregation                                | Properties and observations  | UN No. |
|--------|------------------------------------|---------------|------------------------|-------------------------|--|--|--------|
|        | Tank instructions                  | Provisions    |                        |                         |  |  |        |
| (12)   | (13)<br>4.2.5<br>4.3               | (14)<br>4.2.5 | (15)<br>5.4.3.4<br>7.8 | (16a)<br>7.1<br>7.3-7.7 | (16b)<br>7.2-7.7                           | (17)   | (18)   |
| -      | T3                                 | TP33          | F-A, S-A               | Category A              | SGG7<br>SGG11                              | White crystals or powder. Soluble in water. Toxic if swallowed, by skin contact or by dust inhalation.   | 1894   |
| -      | T3                                 | TP33          | F-A, S-A               | Category A              | SGG7<br>SGG11                              | White crystals or powder. Toxic if swallowed, by skin contact or by inhalation.  | 1895   |
| -      | T4                                 | TP1           | F-A, S-A               | Category A<br>SW2       | SGG10                                      | Colourless liquid with an ethereal odour. When involved in a fire, evolves extremely toxic fumes (phosgene). Toxic if swallowed, by skin contact or by inhalation.   | 1897   |
| -      | T7                                 | TP2<br>TP13   | F-A, S-B               | Category C<br>SW2       | SGG1<br>SG36<br>SG49                       | Colourless liquid. Reacts violently with water, evolving hydrogen iodide, an irritating and corrosive gas apparent as white fumes. In the presence of moisture, highly corrosive to most metals. Vapour irritates mucous membranes.  | 1898   |
| -      | T4                                 | TP1           | F-A, S-B               | Category A              | SGG1<br>SG36<br>SG49                       | Oily liquid. Mildly corrosive to most metals.  | 1902   |
| -      | -                                  | -             | F-A, S-B               | Category B              | -  | A wide variety of corrosive liquids. Cause burns to skin, eyes and mucous membranes.   | 1903   |
| -      | -                                  | -             | F-A, S-B               | Category B              | -  | See entry above.   | 1903   |
| -      | -                                  | -             | F-A, S-B               | Category A              | -  | See entry above.   | 1903   |
| -      | T6                                 | TP33          | F-A, S-B               | Category A              | SGG1<br>SG36<br>SG49                       | White, very deliquescent crystalline solid. Melting point: 50°C. Soluble in water. Reacts violently with organic materials such as wood, cotton or straw. In the presence of moisture, corrosive to most metals. Causes severe burns to skin, eyes and mucous membranes.   | 1905   |
| -      | T8                                 | TP2<br>TP28   | F-A, S-B               | Category C<br>SW15      | SGG1<br>SG36<br>SG49                       | Waste or spent sulphuric acid, usually a by-product of refining petroleum oils or crude benzenes. Highly corrosive to most metals.   | 1906   |
| -      | T1                                 | TP33          | F-A, S-B               | Category A              | SGG18<br>SG35                              | Deliquescent, granulated mixture of sodium hydroxide and calcium hydroxide. Reacts violently with acids. Reacts with ammonium salts, evolving ammonia gas. In the presence of moisture, corrosive to aluminium, zinc and tin. Causes burns to skin, eyes and mucous membranes.   | 1907   |
| -      | T7                                 | TP2<br>TP24   | F-A, S-B               | Category B              | SGG5<br>SG6<br>SG8<br>SG10<br>SG12<br>SG20 | Colourless liquid. In contact with acids, evolves very irritating and corrosive gases. Oxidizing solution. May cause fire in contact with organic materials such as wood, cotton or straw. Mildly corrosive to most metals. Causes burns to skin, eyes and mucous membranes.   | 1908   |
| -      | T4                                 | TP2<br>TP24   | F-A, S-B               | Category B              | SGG5<br>SG6<br>SG8<br>SG10<br>SG12<br>SG20 | See entry above.   | 1908   |
| -      | -                                  | -             | -                      | -                       | -  | Not subject to the provisions of this Code but may be subject to provisions governing the transport of dangerous goods by other modes.   | 1910   |
| -      | -                                  | -             | F-D, S-U               | Category D<br>SW2       | SG46                                       | Liquefied, flammable, toxic, colourless gas with an unpleasant odour. Explosive limits: 0.9% to 98%. Lighter than air (0.95). May decompose above -18°C with the formation of hydrogen and boron hydrides. Autoignition temperature: 90°C. Toxic by inhalation; forms boric acid and water by hydrolysis within the lungs. | 1911   |
| -      | T50                                | -             | F-D, S-U               | Category D<br>SW2       | -  | Solution of the flammable gas methyl chloride, UN No. 1063, in the liquid methylene chloride.  | 1912   |
| -      | T75                                | TP5           | F-C, S-V               | Category D              | -  | Liquefied, inert gas. Lighter than air (0.7).  | 1913   |



Part 3 – Dangerous Goods List, special provisions and exceptions

Chapter 3.2 – Dangerous Goods List

| UN No. | Proper shipping name (PSN)                     | Class or division | Subsidiary hazard(s) | Packing group  | Special provisions | Limited and excepted quantity provisions |                     | Packing      |              | IBC           |               |
|--------|--|-------------------|----------------------|----------------|--------------------|--|---------------------|--------------|--------------|---------------|---------------|
|        |  |                   |                      |                |                    | Limited quantities                       | Excepted quantities | Instructions | Provisions   | Instructions  | Provisions    |
| (1)    | (2)<br>3.1.2                                   | (3)<br>2.0        | (4)<br>2.0           | (5)<br>2.0.1.3 | (6)<br>3.3         | (7a)<br>3.4                              | (7b)<br>3.5         | (8)<br>4.1.4 | (9)<br>4.1.4 | (10)<br>4.1.4 | (11)<br>4.1.4 |
| 1914   | BUTYL PROPIONATES                              | 3                 | –                    | III            | –                  | 5 L                                      | E1                  | P001<br>LP01 | –            | IBC03         | –             |
| 1915   | CYCLOHEXANONE                                  | 3                 | –                    | III            | –                  | 5 L                                      | E1                  | P001<br>LP01 | –            | IBC03         | –             |
| 1916   | 2,2'-DICHLORODIETHYL ETHER                     | 6.1               | 3                    | II             | –                  | 100 mL                                   | E4                  | P001         | –            | IBC02         | –             |
| 1917   | ETHYL ACRYLATE, STABILIZED                     | 3                 | –                    | II             | 386                | 1 L                                      | E2                  | P001         | –            | IBC02         | –             |
| 1918   | ISOPROPYLBENZENE                               | 3                 | –                    | III            | –                  | 5 L                                      | E1                  | P001<br>LP01 | –            | IBC03         | –             |
| 1919   | METHYL ACRYLATE, STABILIZED                    | 3                 | –                    | II             | 386                | 1 L                                      | E2                  | P001         | –            | IBC02         | –             |
| 1920   | NONANES  | 3                 | –<br>P               | III            | –                  | 5 L                                      | E1                  | P001<br>LP01 | –            | IBC03         | –             |
| 1921   | PROPYLENEIMINE, STABILIZED                     | 3                 | 6.1                  | I              | 386                | 0  | E0                  | P001         | –            | –             | –             |
| 1922   | PYRROLIDINE                                    | 3                 | 8                    | II             | –                  | 1 L                                      | E2                  | P001         | –            | IBC02         | –             |
| 1923   | CALCIUM DITHIONITE (CALCIUM HYDROSULPHITE)     | 4.2               | –                    | II             | –                  | 0  | E2                  | P410         | PP31         | IBC06         | B21           |
| 1928   | METHYLMAGNESIUM BROMIDE IN ETHYL ETHER         | 4.3               | 3                    | I              | –                  | 0  | E0                  | P402         | –            | –             | –             |
| 1929   | POTASSIUM DITHIONITE (POTASSIUM HYDROSULPHITE) | 4.2               | –                    | II             | –                  | 0  | E2                  | P410         | PP31         | IBC06         | B21           |
| 1931   | ZINC DITHIONITE (ZINC HYDROSULPHITE)           | 9                 | –                    | III            | –                  | 5 kg                                     | E1                  | P002<br>LP02 | –            | IBC08         | B3            |
| 1932   | ZIRCONIUM SCRAP                                | 4.2               | –                    | III            | 223                | 0  | E0                  | P002<br>LP02 | PP31<br>L4   | IBC08         | B4            |
| 1935   | CYANIDE SOLUTION, N.O.S.                       | 6.1               | –<br>P               | I              | 274                | 0  | E5                  | P001         | –            | –             | –             |
| 1935   | CYANIDE SOLUTION, N.O.S.                       | 6.1               | –<br>P               | II             | 274                | 100 mL                                   | E4                  | P001         | –            | IBC02         | –             |
| 1935   | CYANIDE SOLUTION, N.O.S.                       | 6.1               | –<br>P               | III            | 223<br>274         | 5 L                                      | E1                  | P001<br>LP01 | –            | IBC03         | –             |
| 1938   | BROMOACETIC ACID SOLUTION                      | 8                 | –                    | II             | –                  | 1 L                                      | E2                  | P001         | –            | IBC02         | –             |
| 1938   | BROMOACETIC ACID SOLUTION                      | 8                 | –                    | III            | 223                | 5 L                                      | E1                  | P001<br>LP01 | –            | IBC03         | –             |

| UN No. | Portable tanks and bulk containers |                     | EmS                    | Stowage and handling     | Segregation          | Properties and observations  | UN No. |
|--------|------------------------------------|---------------------|------------------------|--------------------------|----------------------|--|--------|
|        | Tank instructions                  | Provisions          |                        |                          |                      |  |        |
| (12)   | (13)<br>4.2.5<br>4.3               | (14)<br>4.2.5       | (15)<br>5.4.3.4<br>7.8 | (16a)<br>7.1<br>7.3–7.7  | (16b)<br>7.2–7.7     | (17)   | (18)   |
| –      | T2                                 | TP1                 | F-E, S-D               | Category A               | –                    | Colourless liquids. Flashpoint: 32°C c.c. Immiscible with water.   | 1914   |
| –      | T2                                 | TP1                 | F-E, S-D               | Category A               | –                    | Colourless liquid. Flashpoint: 38°C to 44°C c.c. Explosive limits: 1.1% to 9.4%. Immiscible with water.  | 1915   |
| –      | T7                                 | TP2                 | F-E, S-D               | Category A               | –                    | Colourless flammable liquid. Flashpoint: 55°C c.c. Immiscible with water, but reacts with it, forming corrosive and toxic fumes. Toxic if swallowed, by skin contact or by inhalation.   | 1916   |
| –      | T4                                 | TP1<br>TP13         | F-E, S-D               | Category C<br>SW1<br>SW2 | –                    | Colourless liquid with a pungent odour. Flashpoint: 16°C c.c. Explosive limits: 1.8% to 14%. Immiscible with water. Irritating to skin, eyes and mucous membranes.   | 1917   |
| –      | T2                                 | TP1                 | F-E, S-E               | Category A               | –                    | Colourless liquid with a chloroform-like odour. Flashpoint: 31°C c.c. Explosive limits: 0.9% to 6.5%. Immiscible with water.   | 1918   |
| –      | T4                                 | TP1<br>TP13         | F-E, S-D               | Category C<br>SW1        | –                    | Colourless, volatile liquid with a pungent odour. Flashpoint: –3°C c.c. Explosive limits: 1.2% to 25%. Immiscible with water. Harmful by inhalation. Irritating to skin, eyes and mucous membranes.                              | 1919   |
| –      | T2                                 | TP2                 | F-E, S-E               | Category A               | –                    | Colourless liquids. Explosive limits: 0.8% to 2.9%. <i>normal</i> -NONANE: flashpoint 31°C c.c. Immiscible with water. Irritating to skin, eyes and mucous membranes.  | 1920   |
| –      | T14                                | TP2<br>TP13         | F-E, S-D               | Category D<br>SW1<br>SW2 | –                    | Colourless liquid with an ammoniacal odour. Flashpoint: –4°C o.c. Miscible with water. Toxic if swallowed, by skin contact or by inhalation. Causes burns to skin and eyes.  | 1921   |
| –      | T7                                 | TP1                 | F-E, S-C               | Category B<br>SW2        | SGG18<br>SG35        | Colourless to pale yellow liquid with an ammoniacal odour. Reacts violently with acids. Flashpoint: 3°C c.c. Miscible with water. Harmful by inhalation. Causes burns to skin, eyes and mucous membranes.                        | 1922   |
| –      | T3                                 | TP33                | F-A, S-J               | Category E<br>H1         | –                    | Liable to heat and ignite spontaneously in air and to evolve sulphur dioxide, an irritating gas.   | 1923   |
| –      | –                                  | –                   | F-G, S-L               | Category D<br>H1         | SG26                 | Colourless, yellowish liquid. Decomposes violently in contact with water. Spillage will ignite spontaneously.  | 1928   |
| –      | T3                                 | TP33                | F-A, S-J               | Category E<br>H1         | –                    | Liable to heat and ignite spontaneously in air and to evolve sulphur dioxide, an irritating gas.   | 1929   |
| –      | T1                                 | TP33                | F-A, S-J               | Category A<br>H1         | SGG7<br>SG11<br>SG20 | White, amorphous solid material. Soluble in water. Liable to heat on contact with moisture and heating results in evolution of sulphur dioxide, an intensely irritating gas. Also evolves sulphur dioxide on contact with acids. | 1931   |
| –      | T1                                 | TP33                | F-G, S-L               | Category D<br>H1         | SG26                 | Particle size larger than 840 microns. Readily flammable; may ignite spontaneously in air. In contact with water, may evolve hydrogen, a flammable gas.  | 1932   |
| –      | T14                                | TP2<br>TP13<br>TP27 | F-A, S-A               | Category B<br>SW2        | SGG6<br>SG35         | Liquid evolving toxic vapour. Reacts with acids or acid fumes, evolving hydrogen cyanide, a highly toxic and flammable gas. Toxic if swallowed, by skin contact or by inhalation.  | 1935   |
| –      | T11                                | TP2<br>TP13<br>TP27 | F-A, S-A               | Category A<br>SW2        | SGG6<br>SG35         | See entry above.   | 1935   |
| –      | T7                                 | TP2<br>TP13<br>TP28 | F-A, S-A               | Category A<br>SW2        | SGG6<br>SG35         | See entry above.   | 1935   |
| –      | T7                                 | TP2                 | F-A, S-B               | Category A<br>SW2        | SGG1<br>SG36<br>SG49 | Corrosive to most metals. Harmful if swallowed. Causes burns to eyes and skin.   | 1938   |
| –      | T7                                 | TP2                 | F-A, S-B               | Category A<br>SW2        | SGG1<br>SG36<br>SG49 | See entry above.   | 1938   |

Part 3 – Dangerous Goods List, special provisions and exceptions

Chapter 3.2 – Dangerous Goods List

| UN No. | Proper shipping name (PSN)   | Class or division | Subsidiary hazard(s) | Packing group  | Special provisions                           | Limited and excepted quantity provisions |                     | Packing       |              | IBC           |               |
|--------|--|-------------------|----------------------|----------------|--|--|---------------------|---------------|--------------|---------------|---------------|
|        |  |                   |                      |                |  | Limited quantities                       | Excepted quantities | Instructions  | Provisions   | Instructions  | Provisions    |
| (1)    | (2)<br>3.1.2   | (3)<br>2.0        | (4)<br>2.0           | (5)<br>2.0.1.3 | (6)<br>3.3                                   | (7a)<br>3.4                              | (7b)<br>3.5         | (8)<br>4.1.4  | (9)<br>4.1.4 | (10)<br>4.1.4 | (11)<br>4.1.4 |
| 1939   | PHOSPHORUS OXYBROMIDE  | 8                 | –                    | II             | –  | 1 kg                                     | E0                  | P002          | –            | IBC08         | B4<br>B21     |
| 1940   | THIOGLYCOLIC ACID  | 8                 | –                    | II             | –  | 1 L                                      | E2                  | P001          | –            | IBC02         | –             |
| 1941   | DIBROMODIFLUOROMETHANE   | 9                 | –                    | III            | –  | 5 L                                      | E1                  | P001<br>LP01  | –            | –             | –             |
| 1942   | AMMONIUM NITRATE with not more than 0.2% combustible substances, including any organic substance calculated as carbon, to the exclusion of any other added substance | 5.1               | –                    | III            | 900<br>952<br>967                            | 5 kg                                     | E1                  | P002<br>LP02  | –            | IBC08         | B3            |
| 1944   | MATCHES, SAFETY (book, card or strike on box)  | 4.1               | –                    | III            | 293<br>294                                   | 5 kg                                     | E1                  | P407          | –            | –             | –             |
| 1945   | MATCHES, WAX 'VESTA'   | 4.1               | –                    | III            | 293<br>294                                   | 5 kg                                     | E1                  | P407          | –            | –             | –             |
| 1950   | AEROSOLS   | 2                 | –<br>See<br>SP63     | –              | 63<br>190<br>277<br>327<br>344<br>381<br>959 | See<br>SP277                             | E0                  | P207<br>LP200 | PP87<br>L2   | –             | –             |
| 1951   | ARGON, REFRIGERATED LIQUID   | 2.2               | –                    | –              | –  | 120 mL                                   | E1                  | P203          | –            | –             | –             |
| 1952   | ETHYLENE OXIDE AND CARBON DIOXIDE MIXTURE with not more than 9% ethylene oxide   | 2.2               | –                    | –              | 392  | 120 mL                                   | E1                  | P200          | –            | –             | –             |
| 1953   | COMPRESSED GAS, TOXIC, FLAMMABLE, N.O.S.   | 2.3               | 2.1                  | –              | 274  | 0  | E0                  | P200          | –            | –             | –             |
| 1954   | COMPRESSED GAS, FLAMMABLE, N.O.S.  | 2.1               | –                    | –              | 274<br>392                                   | 0  | E0                  | P200          | –            | –             | –             |
| 1955   | COMPRESSED GAS, TOXIC, N.O.S.  | 2.3               | –                    | –              | 274  | 0  | E0                  | P200          | –            | –             | –             |
| 1956   | COMPRESSED GAS, N.O.S.   | 2.2               | –                    | –              | 274<br>378<br>392                            | 120 mL                                   | E1                  | P200          | –            | –             | –             |
| 1957   | DEUTERIUM, COMPRESSED  | 2.1               | –                    | –              | –  | 0  | E0                  | P200          | –            | –             | –             |
| 1958   | 1,2-DICHLORO-1,1,2,2-TETRAFLUOROETHANE (REFRIGERANT GAS R 114)   | 2.2               | –                    | –              | –  | 120 mL                                   | E1                  | P200          | –            | –             | –             |
| 1959   | 1,1-DIFLUOROETHYLENE (REFRIGERANT GAS R 1132a)   | 2.1               | –                    | –              | –  | 0  | E0                  | P200          | –            | –             | –             |

| UN No. | Portable tanks and bulk containers |               | EmS                    | Stowage and handling              | Segregation  | Properties and observations  | UN No. |
|--------|------------------------------------|---------------|------------------------|-----------------------------------|--|--|--------|
|        | Tank instructions                  | Provisions    |                        |                                   |  |  |        |
| (12)   | (13)<br>4.2.5<br>4.3               | (14)<br>4.2.5 | (15)<br>5.4.3.4<br>7.8 | (16a)<br>7.1<br>7.3–7.7           | (16b)<br>7.2–7.7   | (17)   | (18)   |
| –      | T3                                 | TP33          | F-A, S-B               | Category C<br>SW1<br>SW2<br>H2    | SGG1<br>SG36<br>SG49   | Colourless crystals. Melting point: 56°C. Reacts violently with water, evolving hydrogen bromide, a toxic and corrosive gas apparent as white fumes. Reacts violently with organic materials (such as wood, cotton, straw), causing fire. Decomposes when heated, evolving toxic and corrosive gases. When involved in a fire, evolves toxic and corrosive gases. In the presence of moisture, highly corrosive to most metals. Causes burns to skin, eyes and mucous membranes.                       | 1939   |
| –      | T7                                 | TP2           | F-A, S-B               | Category A                        | SGG1<br>SG36<br>SG49   | Colourless liquid with a strong, very unpleasant odour. Corrosive to most metals. Harmful if swallowed.  | 1940   |
| –      | T11                                | TP2           | F-A, S-A               | Category A<br>SW1                 | –  | Colourless, heavy liquid. Boiling point: 24°C. Immiscible with water. When involved in a fire, may evolve toxic fumes. Toxic if swallowed, by skin contact or by inhalation. Irritating to skin, eyes and mucous membranes.  | 1941   |
| –      | T1<br>BK2<br>BK3                   | TP33          | F-H, S-Q               | Category C<br>SW1<br>SW14<br>SW23 | SGG2<br>SG16<br>SG42<br>SG45<br>SG47<br>SG48<br>SG51<br>SG56<br>SG58<br>SG59<br>SG61 | Crystals, granules or prills. Soluble in water. Supporter of combustion. A major fire aboard a ship carrying this substance may involve a risk of explosion in the event of contamination (e.g. by fuel oil) or strong confinement. An adjacent detonation may also involve the risk of explosion. If heated strongly, decomposes, giving off toxic gases and gases which support combustion. Transport of AMMONIUM NITRATE liable to self-heating sufficient to initiate decomposition is prohibited. | 1942   |
| –      | –                                  | –             | F-A, S-I               | Category A                        | –  | Intended to be ignited on a specially prepared surface.  | 1944   |
| –      | –                                  | –             | F-A, S-I               | Category B                        | –  | Ignite by friction; a prepared surface may be required.  | 1945   |
| –      | –                                  | –             | F-D, S-U               | –<br>SW1<br>SW22                  | SG69   | –  | 1950   |
| –      | T75                                | TP5           | F-C, S-V               | Category D                        | –  | Liquefied, inert gas. Heavier than air (1.4).  | 1951   |
| –      | –                                  | –             | F-C, S-V               | Category A                        | –  | Liquefied, non-flammable gas with an ether-like odour. Explosive limits: 31% to 52%. Heavier than air (1.5).   | 1952   |
| –      | –                                  | –             | F-D, S-U               | Category D<br>SW2                 | –  | –  | 1953   |
| –      | –                                  | –             | F-D, S-U               | Category D<br>SW2                 | –  | –  | 1954   |
| –      | –                                  | –             | F-C, S-U               | Category D<br>SW2                 | –  | –  | 1955   |
| –      | –                                  | –             | F-C, S-V               | Category A                        | –  | –  | 1956   |
| –      | –                                  | –             | F-D, S-U               | Category E<br>SW2                 | –  | Flammable, odourless gas. Much lighter than air (0.14).  | 1957   |
| –      | T50                                | –             | F-C, S-V               | Category A                        | –  | Liquefied, non-flammable gas with a chloroform-like odour. Much heavier than air (5.9). Boiling point: 4°C.  | 1958   |
| –      | –                                  | –             | F-D, S-U               | Category E<br>SW2                 | –  | Flammable gas. Explosive limits: 2.3% to 25%. Much heavier than air (2.2).   | 1959   |

Part 3 – Dangerous Goods List, special provisions and exceptions

Chapter 3.2 – Dangerous Goods List

| UN No. | Proper shipping name (PSN)   | Class or division | Subsidiary hazard(s) | Packing group  | Special provisions | Limited and excepted quantity provisions |                     | Packing      |              | IBC           |               |
|--------|--|-------------------|----------------------|----------------|--------------------|--|---------------------|--------------|--------------|---------------|---------------|
|        |  |                   |                      |                |                    | Limited quantities                       | Excepted quantities | Instructions | Provisions   | Instructions  | Provisions    |
| (1)    | (2)<br>3.1.2   | (3)<br>2.0        | (4)<br>2.0           | (5)<br>2.0.1.3 | (6)<br>3.3         | (7a)<br>3.4                              | (7b)<br>3.5         | (8)<br>4.1.4 | (9)<br>4.1.4 | (10)<br>4.1.4 | (11)<br>4.1.4 |
| 1961   | ETHANE, REFRIGERATED LIQUID  | 2.1               | -                    | -              | -                  | 0  | E0                  | P203         | -            | -             | -             |
| 1962   | ETHYLENE   | 2.1               | -                    | -              | -                  | 0  | E0                  | P200         | -            | -             | -             |
| 1963   | HELIUM, REFRIGERATED LIQUID  | 2.2               | -                    | -              | -                  | 120 mL                                   | E1                  | P203         | -            | -             | -             |
| 1964   | HYDROCARBON GAS MIXTURE, COMPRESSED, N.O.S.  | 2.1               | -                    | -              | 274                | 0  | E0                  | P200         | -            | -             | -             |
| 1965   | HYDROCARBON GAS MIXTURE, LIQUEFIED, N.O.S.   | 2.1               | -                    | -              | 274<br>392         | 0  | E0                  | P200         | -            | -             | -             |
| 1966   | HYDROGEN, REFRIGERATED LIQUID  | 2.1               | -                    | -              | -                  | 0  | E0                  | P203         | -            | -             | -             |
| 1967   | INSECTICIDE GAS, TOXIC, N.O.S.   | 2.3               | -                    | -              | 274                | 0  | E0                  | P200         | -            | -             | -             |
| 1968   | INSECTICIDE GAS, N.O.S.  | 2.2               | -                    | -              | 274                | 120 mL                                   | E1                  | P200         | -            | -             | -             |
| 1969   | ISOBUTANE  | 2.1               | -                    | -              | 392                | 0  | E0                  | P200         | -            | -             | -             |
| 1970   | KRYPTON, REFRIGERATED LIQUID   | 2.2               | -                    | -              | -                  | 120 mL                                   | E1                  | P203         | -            | -             | -             |
| 1971   | METHANE, COMPRESSED or NATURAL GAS, COMPRESSED with high methane content   | 2.1               | -                    | -              | 392<br>974         | 0  | E0                  | P200         | -            | -             | -             |
| 1972   | METHANE, REFRIGERATED LIQUID or NATURAL GAS, REFRIGERATED LIQUID with high methane content   | 2.1               | -                    | -              | -                  | 0  | E0                  | P203         | -            | -             | -             |
| 1973   | CHLORODIFLUOROMETHANE AND CHLOROPENTAFLUOROETHANE MIXTURE with fixed boiling point, with approximately 49% chlorodifluoromethane (REFRIGERANT GAS R 502) | 2.2               | -                    | -              | -                  | 120 mL                                   | E1                  | P200         | -            | -             | -             |
| 1974   | CHLORODIFLUOROBROMOMETHANE (REFRIGERANT GAS R 12B1)  | 2.2               | -                    | -              | -                  | 120 mL                                   | E1                  | P200         | -            | -             | -             |
| 1975   | NITRIC OXIDE AND DINITROGEN TETROXIDE MIXTURE (NITRIC OXIDE AND NITROGEN DIOXIDE MIXTURE)  | 2.3               | 5.1/8                | -              | -                  | 0  | E0                  | P200         | -            | -             | -             |
| 1976   | OCTAFLUOROCYCLOBUTANE (REFRIGERANT GAS RC 318)   | 2.2               | -                    | -              | -                  | 120 mL                                   | E1                  | P200         | -            | -             | -             |
| 1977   | NITROGEN, REFRIGERATED LIQUID  | 2.2               | -                    | -              | 345<br>346         | 120 mL                                   | E1                  | P203         | -            | -             | -             |
| 1978   | PROPANE  | 2.1               | -                    | -              | 392                | 0  | E0                  | P200         | -            | -             | -             |
| 1982   | TETRAFLUOROMETHANE (REFRIGERANT GAS R 14)  | 2.2               | -                    | -              | -                  | 120 mL                                   | E1                  | P200         | -            | -             | -             |

| UN No. | Portable tanks and bulk containers |               | EmS                    | Stowage and handling    | Segregation      | Properties and observations   | UN No. |
|--------|------------------------------------|---------------|------------------------|-------------------------|------------------|---|--------|
|        | Tank instructions                  | Provisions    |                        |                         |                  |   |        |
| (12)   | (13)<br>4.2.5<br>4.3               | (14)<br>4.2.5 | (15)<br>5.4.3.4<br>7.8 | (16a)<br>7.1<br>7.3-7.7 | (16b)<br>7.2-7.7 | (17)  | (18)   |
| -      | T75                                | TP5           | F-D, S-U               | Category D SW2          | -                | Liquefied, flammable gas with a faint odour. Explosive limits: 3% to 16%. Slightly heavier than air (1.05).   | 1961   |
| -      | -                                  | -             | F-D, S-U               | Category E SW2          | -                | Flammable gas. Explosive limits: 3% to 34%. Slightly lighter than air (0.98).   | 1962   |
| -      | T75                                | TP5<br>TP34   | F-C, S-V               | Category D              | -                | Liquefied, inert gas. Much lighter than air (0.14).   | 1963   |
| -      | -                                  | -             | F-D, S-U               | Category E SW2          | -                | Flammable hydrocarbon gas mixture obtained from natural gas or by distillation of mineral oils or coal, etc. May contain propane, cyclopropane, propylene, butane, butylene, etc., in varying proportions. Heavier than air.  | 1964   |
| -      | T50                                | -             | F-D, S-U               | Category E SW2          | -                | Liquefied flammable hydrocarbon gas obtained from natural gas or by distillation of mineral oils or coal, etc. May contain propane, cyclopropane, propylene, butane, butylene, etc., in varying proportions. Heavier than air.  | 1965   |
| -      | T75                                | TP5<br>TP34   | F-D, S-U               | Category D SW2          | SG46             | Liquefied, flammable, odourless gas. Explosive limits: 4% to 75%. Much lighter than air (0.07).   | 1966   |
| -      | -                                  | -             | F-C, S-U               | Category D SW2          | -                | Toxic mixtures of insecticides with liquefied gases. These mixtures may be flammable.   | 1967   |
| -      | -                                  | -             | F-C, S-V               | Category A              | -                | Non-flammable and non-toxic mixtures of insecticides with liquefied gases.  | 1968   |
| -      | T50                                | -             | F-D, S-U               | Category E SW2          | -                | Flammable hydrocarbon. Heavier than air.  | 1969   |
| -      | T75                                | TP5           | F-C, S-V               | Category D              | -                | Liquefied, inert gas. Much heavier than air (2.9).  | 1970   |
| -      | -                                  | -             | F-D, S-U               | Category E SW2          | -                | Flammable gas. Explosive limits: 5% to 16%. Lighter than air (methane 0.55).  | 1971   |
| -      | T75                                | TP5           | F-D, S-U               | Category D SW2          | -                | Liquefied, flammable gas. Explosive limits: 5% to 16%. Lighter than air (methane 0.55).   | 1972   |
| -      | T50                                | -             | F-C, S-V               | Category A              | -                | Liquefied, non-flammable gas. Much heavier than air (4.2).  | 1973   |
| -      | T50                                | -             | F-C, S-V               | Category A              | -                | Liquefied, non-flammable gas. Much heavier than air (5.7).  | 1974   |
| -      | -                                  | -             | F-C, S-W               | Category D SW2          | SG6<br>SG19      | Non-flammable, toxic and corrosive, brown gas mixtures of varying composition with a pungent odour. Strong oxidizing agent. Heavier than air. Highly irritating to skin, eyes and mucous membranes. Toxic by inhalation, with delayed effect similar to phosgene.                               | 1975   |
| -      | T50                                | -             | F-C, S-V               | Category A              | -                | Liquefied, non-flammable gas. Much heavier than air (7.0).  | 1976   |
| -      | T75                                | TP5           | F-C, S-V               | Category D              | -                | Liquefied, non-flammable, odourless gas. Lighter than air (0.97). Arrangements for the containment of the liquid nitrogen and fittings in use should be appropriate to the potential danger to the structure of the freight container or ship from the effect of misuse or accidental spillage. | 1977   |
| -      | T50                                | -             | F-D, S-U               | Category E SW2          | -                | Flammable hydrocarbon gas. Explosive limits: 2.3% to 9.5%. Heavier than air (1.56).   | 1978   |
| -      | -                                  | -             | F-C, S-V               | Category A              | -                | Non-flammable gas. Much heavier than air (3.1).   | 1982   |



Part 3 – Dangerous Goods List, special provisions and exceptions

Chapter 3.2 – Dangerous Goods List

| UN No. | Proper shipping name (PSN)                              | Class or division | Subsidiary hazard(s) | Packing group  | Special provisions | Limited and excepted quantity provisions |                     | Packing      |              | IBC           |               |
|--------|---|-------------------|----------------------|----------------|--------------------|--|---------------------|--------------|--------------|---------------|---------------|
|        |   |                   |                      |                |                    | Limited quantities                       | Excepted quantities | Instructions | Provisions   | Instructions  | Provisions    |
| (1)    | (2)<br>3.1.2  | (3)<br>2.0        | (4)<br>2.0           | (5)<br>2.0.1.3 | (6)<br>3.3         | (7a)<br>3.4                              | (7b)<br>3.5         | (8)<br>4.1.4 | (9)<br>4.1.4 | (10)<br>4.1.4 | (11)<br>4.1.4 |
| 1983   | 1-CHLORO-2,2,2-TRIFLUOROETHANE (REFRIGERANT GAS R 133a) | 2.2               | –                    | –              | –                  | 120 mL                                   | E1                  | P200         | –            | –             | –             |
| 1984   | TRIFLUOROMETHANE (REFRIGERANT GAS R 23)                 | 2.2               | –                    | –              | –                  | 120 mL                                   | E1                  | P200         | –            | –             | –             |
| 1986   | ALCOHOLS, FLAMMABLE, TOXIC, N.O.S.                      | 3                 | 6.1                  | I              | 274                | 0  | E0                  | P001         | –            | –             | –             |
| 1986   | ALCOHOLS, FLAMMABLE, TOXIC, N.O.S.                      | 3                 | 6.1                  | II             | 274                | 1 L                                      | E2                  | P001         | –            | IBC02         | –             |
| 1986   | ALCOHOLS, FLAMMABLE, TOXIC, N.O.S.                      | 3                 | 6.1                  | III            | 223<br>274         | 5 L                                      | E1                  | P001         | –            | IBC03         | –             |
| 1987   | ALCOHOLS, N.O.S.  | 3                 | –                    | II             | 274                | 1 L                                      | E2                  | P001         | –            | IBC02         | –             |
| 1987   | ALCOHOLS, N.O.S.  | 3                 | –                    | III            | 223<br>274         | 5 L                                      | E1                  | P001<br>LP01 | –            | IBC03         | –             |
| 1988   | ALDEHYDES, FLAMMABLE, TOXIC, N.O.S.                     | 3                 | 6.1                  | I              | 274                | 0  | E0                  | P001         | –            | –             | –             |
| 1988   | ALDEHYDES, FLAMMABLE, TOXIC, N.O.S.                     | 3                 | 6.1                  | II             | 274                | 1 L                                      | E2                  | P001         | –            | IBC02         | –             |
| 1988   | ALDEHYDES, FLAMMABLE, TOXIC, N.O.S.                     | 3                 | 6.1                  | III            | 223<br>274         | 5 L                                      | E1                  | P001         | –            | IBC03         | –             |
| 1989   | ALDEHYDES, N.O.S.                                       | 3                 | –                    | I              | 274                | 0  | E3                  | P001         | –            | –             | –             |
| 1989   | ALDEHYDES, N.O.S.                                       | 3                 | –                    | II             | 274                | 1 L                                      | E2                  | P001         | –            | IBC02         | –             |
| 1989   | ALDEHYDES, N.O.S.                                       | 3                 | –                    | III            | 223<br>274         | 5 L                                      | E1                  | P001<br>LP01 | –            | IBC03         | –             |
| 1990   | BENZALDEHYDE  | 9                 | –                    | III            | –                  | 5 L                                      | E1                  | P001<br>LP01 | –            | IBC03         | –             |
| 1991   | CHLOROPRENE, STABILIZED                                 | 3                 | 6.1                  | I              | 386                | 0  | E0                  | P001         | –            | –             | –             |
| 1992   | FLAMMABLE LIQUID, TOXIC, N.O.S.                         | 3                 | 6.1                  | I              | 274                | 0  | E0                  | P001         | –            | –             | –             |
| 1992   | FLAMMABLE LIQUID, TOXIC, N.O.S.                         | 3                 | 6.1                  | II             | 274                | 1 L                                      | E2                  | P001         | –            | IBC02         | –             |
| 1992   | FLAMMABLE LIQUID, TOXIC, N.O.S.                         | 3                 | 6.1                  | III            | 223<br>274         | 5 L                                      | E1                  | P001         | –            | IBC03         | –             |
| 1993   | FLAMMABLE LIQUID, N.O.S.                                | 3                 | –                    | I              | 274                | 0  | E3                  | P001         | –            | –             | –             |
| 1993   | FLAMMABLE LIQUID, N.O.S.                                | 3                 | –                    | II             | 274                | 1 L                                      | E2                  | P001         | –            | IBC02         | –             |
| 1993   | FLAMMABLE LIQUID, N.O.S.                                | 3                 | –                    | III            | 223<br>274<br>955  | 5 L                                      | E1                  | P001<br>LP01 | –            | IBC03         | –             |
| 1994   | IRON PENTACARBONYL                                      | 6.1               | 3                    | I              | 354                | 0  | E0                  | P601         | –            | –             | –             |

| UN No. | Portable tanks and bulk containers |                     | EmS                    | Stowage and handling     | Segregation      | Properties and observations  | UN No. |
|--------|------------------------------------|---------------------|------------------------|--------------------------|------------------|--|--------|
|        | Tank instructions                  | Provisions          |                        |                          |                  |  |        |
| (12)   | (13)<br>4.2.5<br>4.3               | (14)<br>4.2.5       | (15)<br>5.4.3.4<br>7.8 | (16a)<br>7.1<br>7.3–7.7  | (16b)<br>7.2–7.7 | (17)   | (18)   |
| –      | T50                                | –                   | F-C, S-V               | Category A               | –                | Liquefied, non-flammable gas. Much heavier than air (4.1). Boiling point: 7°C.   | 1983   |
| –      | –                                  | –                   | F-C, S-V               | Category A               | –                | Liquefied, non-flammable gas. Much heavier than air (2.4).   | 1984   |
| –      | T14                                | TP2<br>TP13<br>TP27 | F-E, S-D               | Category E<br>SW2        | –                | Toxic if swallowed, by skin contact or by inhalation.  | 1986   |
| –      | T11                                | TP2<br>TP27         | F-E, S-D               | Category B<br>SW2        | –                | See entry above.   | 1986   |
| –      | T7                                 | TP1<br>TP28         | F-E, S-D               | Category A               | –                | See entry above.   | 1986   |
| –      | T7                                 | TP1<br>TP8<br>TP28  | F-E, S-D               | Category B               | –                | –  | 1987   |
| –      | T4                                 | TP1<br>TP29         | F-E, S-D               | Category A               | –                | –  | 1987   |
| –      | T14                                | TP2<br>TP13<br>TP27 | F-E, S-D               | Category E<br>SW2        | –                | Toxic if swallowed, by skin contact or by inhalation.  | 1988   |
| –      | T11                                | TP2<br>TP27         | F-E, S-D               | Category B<br>SW2        | –                | See entry above.   | 1988   |
| –      | T7                                 | TP1<br>TP28         | F-E, S-D               | Category A               | –                | See entry above.   | 1988   |
| –      | T11                                | TP1<br>TP27         | F-E, S-D               | Category E               | –                | –  | 1989   |
| –      | T7                                 | TP1<br>TP8<br>TP28  | F-E, S-D               | Category B               | –                | –  | 1989   |
| –      | T4                                 | TP1<br>TP29         | F-E, S-D               | Category A               | –                | –  | 1989   |
| –      | T2                                 | TP1                 | F-A, S-A               | Category A               | –                | Colourless or yellowish volatile oil with a bitter almond odour. Slightly soluble in water. Irritating to skin, eyes and mucous membranes.   | 1990   |
| –      | T14                                | TP2<br>TP6<br>TP13  | F-E, S-D               | Category D<br>SW1<br>SW2 | SGG10            | Colourless liquid. Flashpoint: –20°C c.c. Explosive limits: 2.5% to 12%. Slightly soluble in water. Toxic if swallowed, by skin contact or by inhalation.  | 1991   |
| –      | T14                                | TP2<br>TP13<br>TP27 | F-E, S-D               | Category E<br>SW2        | –                | Flammable toxic liquid which is not specified by name in this class or, on account of its characteristics, in some other class. Toxic if swallowed, by skin contact or by inhalation.  | 1992   |
| –      | T7                                 | TP2<br>TP13         | F-E, S-D               | Category B<br>SW2        | –                | See entry above.   | 1992   |
| –      | T7                                 | TP1<br>TP28         | F-E, S-D               | Category A               | –                | See entry above.   | 1992   |
| –      | T11                                | TP1<br>TP27         | F-E, <u>S-E</u>        | Category E               | –                | –  | 1993   |
| –      | T7                                 | TP1<br>TP8<br>TP28  | F-E, <u>S-E</u>        | Category B               | –                | –  | 1993   |
| –      | T4                                 | TP1<br>TP29         | F-E, <u>S-E</u>        | Category A               | –                | –  | 1993   |
| –      | T22                                | TP2<br>TP13         | F-E, S-D               | Category D<br>SW2        | –                | Yellow to dark red, volatile flammable liquid. Flashpoint: –15°C c.c. Explosive limits: 3.7% to 12.5%. May react with water or steam, evolving carbon monoxide, which is a toxic gas. Highly toxic if swallowed, by skin contact or by inhalation. | 1994   |

Part 3 – Dangerous Goods List, special provisions and exceptions

Chapter 3.2 – Dangerous Goods List

| UN No. | Proper shipping name (PSN)   | Class or division | Subsidiary hazard(s) | Packing group  | Special provisions | Limited and excepted quantity provisions |                     | Packing      |              | IBC           |               |
|--------|--|-------------------|----------------------|----------------|--------------------|--|---------------------|--------------|--------------|---------------|---------------|
|        |  |                   |                      |                |                    | Limited quantities                       | Excepted quantities | Instructions | Provisions   | Instructions  | Provisions    |
| (1)    | (2)<br>3.1.2   | (3)<br>2.0        | (4)<br>2.0           | (5)<br>2.0.1.3 | (6)<br>3.3         | (7a)<br>3.4                              | (7b)<br>3.5         | (8)<br>4.1.4 | (9)<br>4.1.4 | (10)<br>4.1.4 | (11)<br>4.1.4 |
| 1999   | TARS, LIQUID, including road oils, and cutback bitumens  | 3                 | –                    | II             | –                  | 5 L                                      | E2                  | P001         | –            | IBC02         | –             |
| 1999   | TARS, LIQUID, including road oils, and cutback bitumens  | 3                 | –                    | III            | 955                | 5 L                                      | E1                  | P001 LP01    | –            | IBC03         | –             |
| 2000   | CELLULOID in block, rods, rolls, sheets, tubes, etc., except scrap   | 4.1               | –                    | III            | 223<br>383         | 5 kg                                     | E1                  | P002 LP02    | PP7          | –             | –             |
| 2001   | COBALT NAPHTHENATES, POWDER  | 4.1               | –                    | III            | –                  | 5 kg                                     | E1                  | P002 LP02    | –            | IBC08         | B3            |
| 2002   | CELLULOID, SCRAP   | 4.2               | –                    | III            | 223                | 0  | E0                  | P002 LP02    | PP8          | IBC08         | B3            |
| 2004   | MAGNESIUM DIAMIDE  | 4.2               | –                    | II             | –                  | 0  | E2                  | P410         | PP31         | IBC06         | –             |
| 2006   | PLASTICS, NITROCELLULOSE-BASED, SELF-HEATING, N.O.S.   | 4.2               | –                    | III            | 274                | 0  | E0                  | P002         | –            | –             | –             |
| 2008   | ZIRCONIUM POWDER, DRY  | 4.2               | –                    | I              | –                  | 0  | E0                  | P404         | PP31         | –             | –             |
| 2008   | ZIRCONIUM POWDER, DRY  | 4.2               | –                    | II             | –                  | 0  | E2                  | P410         | PP31         | IBC06         | B21           |
| 2008   | ZIRCONIUM POWDER, DRY  | 4.2               | –                    | III            | 223                | 0  | E1                  | P002 LP02    | PP31 L4      | IBC08         | B4            |
| 2009   | ZIRCONIUM, DRY, finished sheets, strip or coiled wire  | 4.2               | –                    | III            | 223                | 0  | E1                  | P002 LP02    | PP31 L4      | –             | –             |
| 2010   | MAGNESIUM HYDRIDE  | 4.3               | –                    | I              | –                  | 0  | E0                  | P403         | PP31         | –             | –             |
| 2011   | MAGNESIUM PHOSPHIDE  | 4.3               | 6.1                  | I              | –                  | 0  | E0                  | P403         | PP31         | –             | –             |
| 2012   | POTASSIUM PHOSPHIDE  | 4.3               | 6.1                  | I              | –                  | 0  | E0                  | P403         | PP31         | –             | –             |
| 2013   | STRONTIUM PHOSPHIDE  | 4.3               | 6.1                  | I              | –                  | 0  | E0                  | P403         | PP31         | –             | –             |
| 2014   | HYDROGEN PEROXIDE, AQUEOUS SOLUTION with not less than 20% but not more than 60% hydrogen peroxide (stabilized as necessary) | 5.1               | 8                    | II             | –                  | 1 L                                      | E2                  | P504         | PP10         | IBC02         | B5            |
| 2015   | HYDROGEN PEROXIDE, STABILIZED or HYDROGEN PEROXIDE, AQUEOUS SOLUTION, STABILIZED with more than 60% hydrogen peroxide        | 5.1               | 8                    | I              | –                  | 0  | E0                  | P501         | –            | –             | –             |
| 2016   | AMMUNITION, TOXIC, NON-EXPLOSIVE without burster or expelling charge, non-fuzed  | 6.1               | –                    | –              | –                  | 0  | E0                  | P600         | –            | –             | –             |
| 2017   | AMMUNITION, TEAR-PRODUCING, NON-EXPLOSIVE without burster or expelling charge, non-fuzed                                     | 6.1               | 8                    | –              | –                  | 0  | E0                  | P600         | –            | –             | –             |

| UN No. | Portable tanks and bulk containers |                    | EmS                    | Stowage and handling           | Segregation                   | Properties and observations   | UN No. |
|--------|------------------------------------|--------------------|------------------------|--------------------------------|-------------------------------|---|--------|
|        | Tank instructions                  | Provisions         |                        |                                |                               |   |        |
| (12)   | (13)<br>4.2.5<br>4.3               | (14)<br>4.2.5      | (15)<br>5.4.3.4<br>7.8 | (16a)<br>7.1<br>7.3–7.7        | (16b)<br>7.2–7.7              | (17)  | (18)   |
| –      | T3                                 | TP3<br>TP29        | F-E, S-E               | Category B                     | –                             | Mobile liquids prepared by mixing asphalt with petroleum distillate. Pungent odour. Immiscible with water.  | 1999   |
| –      | T1                                 | TP3                | F-E, S-E               | Category A                     | –                             | See entry above.  | 1999   |
| –      | –                                  | –                  | F-A, S-I               | Category A                     | –                             | Ignites readily. When involved in a fire, evolves toxic fumes; in enclosed cargo spaces, these fumes may form an explosive mixture with air.  | 2000   |
| –      | T1                                 | TP33               | F-A, S-I               | Category A                     | –                             | Brown, amorphous powder. Insoluble in water. Readily combustible.   | 2001   |
| –      | –                                  | –                  | F-A, S-J               | Category D                     | –                             | Ignites readily. When involved in a fire, evolves toxic fumes; in enclosed cargo spaces, these fumes may form an explosive mixture with air.  | 2002   |
| –      | T3                                 | TP33               | F-G, S-M               | Category C<br>H1               | SG26                          | White powder. Ignites spontaneously in air. Reacts violently in contact with water.   | 2004   |
| –      | –                                  | –                  | F-A, S-G               | Category C                     | –                             | –   | 2006   |
| –      | T21                                | TP7<br>TP33        | F-G, S-M               | Category D<br>H1               | SGG15<br>SG26                 | Amorphous powder. Liable to ignite spontaneously in air. Forms explosive mixtures with oxidizing substances.  | 2008   |
| –      | T3                                 | TP33               | F-G, S-M               | Category D<br>H1               | SGG15<br>SG26                 | See entry above.  | 2008   |
| –      | T1                                 | TP33               | F-G, S-M               | Category D<br>H1               | SGG15<br>SG26                 | See entry above.  | 2008   |
| –      | –                                  | –                  | F-G, S-M               | Category D<br>H1               | SGG15<br>SG26                 | Hard, silvery metal, liable to ignite spontaneously in air.   | 2009   |
| –      | –                                  | –                  | F-G, S-O               | Category E<br>H1               | SG26<br>SG35                  | White crystals. In contact with water, acids or moisture, evolves hydrogen, which may be ignited by the heat of the reaction.   | 2010   |
| –      | –                                  | –                  | F-G, S-N               | Category E<br>SW2<br>SW5<br>H1 | SG26<br>SG35                  | Solid. Reacts with acids or decomposes slowly in contact with water or damp air, evolving phosphine, a spontaneously flammable and highly toxic gas. Reacts violently with oxidizing substances. Toxic if swallowed, by skin contact or by inhalation.  | 2011   |
| –      | –                                  | –                  | F-G, S-N               | Category E<br>SW2<br>SW5<br>H1 | SG26<br>SG35                  | Solid. Reacts with acids or decomposes slowly in contact with water or damp air, evolving phosphine, a spontaneously flammable and highly toxic gas. Reacts violently with oxidizing substances. Toxic if swallowed, by skin contact or by inhalation.  | 2012   |
| –      | –                                  | –                  | F-G, S-N               | Category E<br>SW2<br>SW5<br>H1 | SG26<br>SG35                  | Solid. Reacts with acids or decomposes slowly in contact with water or damp air, evolving phosphine, a spontaneously flammable and highly toxic gas. Reacts violently with oxidizing substances. Toxic if swallowed, by skin contact or by inhalation.  | 2013   |
| –      | T7                                 | TP2<br>TP6<br>TP24 | F-H, S-Q               | Category D<br>SW1              | SGG16<br>SG16<br>SG59<br>SG72 | Colourless liquid. Slowly decomposes, evolving oxygen; the rate of decomposition increases in contact with metals, except aluminium. In contact with combustible material, may cause fire or explosion. Causes burns to skin, eyes and mucous membranes. Even though stabilized, these solutions may evolve oxygen.   | 2014   |
| –      | T9                                 | TP2<br>TP6<br>TP24 | F-H, S-Q               | Category D<br>SW1              | SGG16<br>SG16<br>SG59         | Colourless liquid. Slowly decomposes, evolving oxygen; the rate of decomposition increases in contact with metals, except aluminium. Decomposes vigorously in contact with permanganates. When involved in a fire, mixtures with combustible material may be explosive. Causes burns to skin, eyes and mucous membranes. Even though stabilized, these solutions may evolve oxygen. | 2015   |
| –      | –                                  | –                  | F-A, S-A               | Category E<br>SW2<br>H1        | –                             | Contents may evolve toxic fumes or vapour. Gases evolved are toxic by skin contact or by inhalation.  | 2016   |
| –      | –                                  | –                  | F-A, S-B               | Category E<br>SW2<br>H1        | –                             | Contents may evolve irritant gas or vapour with lachrymatory effects.   | 2017   |

Part 3 – Dangerous Goods List, special provisions and exceptions

Chapter 3.2 – Dangerous Goods List

| UN No. | Proper shipping name (PSN)   | Class or division | Subsidiary hazard(s) | Packing group  | Special provisions     | Limited and excepted quantity provisions |                     | Packing      |              | IBC           |               |
|--------|--|-------------------|----------------------|----------------|------------------------|--|---------------------|--------------|--------------|---------------|---------------|
|        |  |                   |                      |                |                        | Limited quantities                       | Excepted quantities | Instructions | Provisions   | Instructions  | Provisions    |
| (1)    | (2)<br>3.1.2   | (3)<br>2.0        | (4)<br>2.0           | (5)<br>2.0.1.3 | (6)<br>3.3             | (7a)<br>3.4                              | (7b)<br>3.5         | (8)<br>4.1.4 | (9)<br>4.1.4 | (10)<br>4.1.4 | (11)<br>4.1.4 |
| 2018   | CHLOROANILINES, SOLID  | 6.1               | –                    | II             | –                      | 500 g                                    | E4                  | P002         | –            | IBC08         | B4<br>B21     |
| 2019   | CHLOROANILINES, LIQUID   | 6.1               | –                    | II             | –                      | 100 mL                                   | E4                  | P001         | –            | IBC02         | –             |
| 2020   | CHLOROPHENOLS, SOLID   | 6.1               | –                    | III            | 205                    | 5 kg                                     | E1                  | P002<br>LP02 | –            | IBC08         | B3            |
| 2021   | CHLOROPHENOLS, LIQUID  | 6.1               | –                    | III            | –                      | 5 L                                      | E1                  | P001<br>LP01 | –            | IBC03         | –             |
| 2022   | CRESYLIC ACID  | 6.1               | 8                    | II             | –                      | 100 mL                                   | E4                  | P001         | –            | IBC02         | –             |
| 2023   | EPICHLOROHYDRIN  | 6.1               | 3<br>P               | II             | 279                    | 100 mL                                   | E4                  | P001         | –            | IBC02         | –             |
| 2024   | MERCURY COMPOUND, LIQUID, N.O.S.   | 6.1               | –<br>P               | I              | 43<br>66<br>274        | 0  | E5                  | P001         | –            | –             | –             |
| 2024   | MERCURY COMPOUND, LIQUID, N.O.S.   | 6.1               | –<br>P               | II             | 43<br>66<br>274        | 100 mL                                   | E4                  | P001         | –            | IBC02         | –             |
| 2024   | MERCURY COMPOUND, LIQUID, N.O.S.   | 6.1               | –<br>P               | III            | 43<br>66<br>223<br>274 | 5 L                                      | E1                  | P001<br>LP01 | –            | IBC03         | –             |
| 2025   | MERCURY COMPOUND, SOLID, N.O.S.  | 6.1               | –<br>P               | I              | 43<br>66<br>274        | 0  | E5                  | P002         | –            | IBC07         | B1            |
| 2025   | MERCURY COMPOUND, SOLID, N.O.S.  | 6.1               | –<br>P               | II             | 43<br>66<br>274        | 500 g                                    | E4                  | P002         | –            | IBC08         | B4<br>B21     |
| 2025   | MERCURY COMPOUND, SOLID, N.O.S.  | 6.1               | –<br>P               | III            | 43<br>66<br>223<br>274 | 5 kg                                     | E1                  | P002<br>LP02 | –            | IBC08         | B3            |
| 2026   | PHENYLMERCURIC COMPOUND, N.O.S.  | 6.1               | –<br>P               | I              | 43<br>274              | 0  | E5                  | P002         | –            | IBC07         | B1            |
| 2026   | PHENYLMERCURIC COMPOUND, N.O.S.  | 6.1               | –<br>P               | II             | 43<br>274              | 500 g                                    | E4                  | P002         | –            | IBC08         | B4<br>B21     |
| 2026   | PHENYLMERCURIC COMPOUND, N.O.S.  | 6.1               | –<br>P               | III            | 43<br>223<br>274       | 5 kg                                     | E1                  | P002<br>LP02 | –            | IBC08         | B3            |
| 2027   | SODIUM ARSENITE, SOLID   | 6.1               | –                    | II             | 43                     | 500 g                                    | E4                  | P002         | –            | IBC08         | B4<br>B21     |
| △ 2028 | BOMBS, SMOKE, NON-EXPLOSIVE with corrosive liquid, without initiating device | 8                 | –                    | –              | –                      | 0  | E0                  | P803         | –            | –             | –             |
| 2029   | HYDRAZINE, ANHYDROUS   | 8                 | 3/6.1                | I              | –                      | 0  | E0                  | P001         | –            | –             | –             |

| UN No. | Portable tanks and bulk containers |               | EmS                    | Stowage and handling    | Segregation                 | Properties and observations  | UN No. |
|--------|------------------------------------|---------------|------------------------|-------------------------|-----------------------------|--|--------|
|        | Tank instructions                  | Provisions    |                        |                         |                             |  |        |
| (12)   | (13)<br>4.2.5<br>4.3               | (14)<br>4.2.5 | (15)<br>5.4.3.4<br>7.8 | (16a)<br>7.1<br>7.3–7.7 | (16b)<br>7.2–7.7            | (17)   | (18)   |
| –      | T3                                 | TP33          | F-A, S-A               | Category A              | –                           | Crystalline solid. Melting point of pure <i>para</i> -chloroaniline: 70°C approximately. Toxic if swallowed, by skin contact or by dust inhalation.  | 2018   |
| –      | T7                                 | TP2           | F-A, S-A               | Category A              | SG35                        | Colourless liquid. May be a mixture of two of the isomers (e.g. <i>ortho</i> - and <i>meta</i> -) of chloroaniline. Reacts with acids. Toxic if swallowed, by skin contact or by inhalation.   | 2019   |
| –      | T1                                 | TP33          | F-A, S-A               | Category A              | –                           | A wide range of toxic solids. Toxic if swallowed, by skin contact or by dust inhalation.   | 2020   |
| –      | T4                                 | TP1           | F-A, S-A               | Category A              | –                           | A wide range of toxic liquids. Toxic if swallowed, by skin contact or by inhalation.   | 2021   |
| –      | T7                                 | TP2<br>TP13   | F-A, S-B               | Category B              | –                           | Colourless to brownish-yellow liquid mixture with a phenolic odour. Miscible with water. Toxic if swallowed, by skin contact or by inhalation. Causes burns to skin, eyes and mucous membranes. "Cresylic acid" is a generic name for mixtures of cresols and higher alkylphenols, in varying proportions. It generally contains more than 95% phenolic compounds.     | 2022   |
| –      | T7                                 | TP2<br>TP13   | F-E, S-D               | Category A<br>SW2       | –                           | Colourless flammable liquid with a chloroform-like odour. Flashpoint: approximately 32°C c.c. Toxic if swallowed, by skin contact or by inhalation.  | 2023   |
| –      | –                                  | –             | F-A, S-A               | Category B<br>SW2       | SGG7<br>SGG11               | Toxic if swallowed, by skin contact or by inhalation.  | 2024   |
| –      | –                                  | –             | F-A, S-A               | Category B<br>SW2       | SGG7<br>SGG11               | See entry above.   | 2024   |
| –      | –                                  | –             | F-A, S-A               | Category B<br>SW2       | SGG7<br>SGG11               | See entry above.   | 2024   |
| –      | T6                                 | TP33          | F-A, S-A               | Category A              | SGG7<br>SGG11               | Toxic if swallowed, by skin contact or by dust inhalation.   | 2025   |
| –      | T3                                 | TP33          | F-A, S-A               | Category A              | SGG7<br>SGG11               | See entry above.   | 2025   |
| –      | T1                                 | TP33          | F-A, S-A               | Category A              | SGG7<br>SGG11               | See entry above.   | 2025   |
| –      | T6                                 | TP33          | F-A, S-A               | Category A              | SGG7<br>SGG11               | Usually white crystals or powder. Toxic if swallowed, by skin contact or by dust inhalation.   | 2026   |
| –      | T3                                 | TP33          | F-A, S-A               | Category A              | SGG7<br>SGG11               | See entry above.   | 2026   |
| –      | T1                                 | TP33          | F-A, S-A               | Category A              | SGG7<br>SGG11               | See entry above.   | 2026   |
| –      | T3                                 | TP33          | F-A, S-A               | Category A              | –                           | Greyish-white powder. Soluble in water. Reacts with oxidizing substances, evolving heat. Toxic if swallowed, by skin contact or by dust inhalation.  | 2027   |
| –      | –                                  | –             | F-A, S-B               | Category E<br>SW2       | –                           | Corrosive content evolves dense smoke when in contact with air. Corrosive content may cause acid burns to skin.  | △ 2028 |
| –      | –                                  | –             | F-E, S-C               | Category D<br>SW2       | SGG18<br>SG5<br>SG8<br>SG35 | Colourless, flammable liquid with an ammoniacal odour. Reacts violently with acids. Flashpoint: 52°C c.c. Miscible with water. Highly reactive reducing agent. Ignites spontaneously when in contact with porous materials such as earth, wood or cloth. Toxic if swallowed, by skin contact or by inhalation. Causes severe burns to skin, eyes and mucous membranes. | 2029   |

Part 3 – Dangerous Goods List, special provisions and exceptions

Chapter 3.2 – Dangerous Goods List

| UN No. | Proper shipping name (PSN)   | Class or division | Subsidiary hazard(s) | Packing group  | Special provisions                     | Limited and excepted quantity provisions |                     | Packing       |                    | IBC           |               |
|--------|--|-------------------|----------------------|----------------|--|--|---------------------|---------------|--------------------|---------------|---------------|
|        |  |                   |                      |                |  | Limited quantities                       | Excepted quantities | Instructions  | Provisions         | Instructions  | Provisions    |
| (1)    | (2)<br>3.1.2   | (3)<br>2.0        | (4)<br>2.0           | (5)<br>2.0.1.3 | (6)<br>3.3                             | (7a)<br>3.4                              | (7b)<br>3.5         | (8)<br>4.1.4  | (9)<br>4.1.4       | (10)<br>4.1.4 | (11)<br>4.1.4 |
| 2030   | HYDRAZINE, AQUEOUS SOLUTION with more than 37% hydrazine, by mass                            | 8                 | 6.1                  | I              | –                                      | 0  | E0                  | P001          | –                  | –             | –             |
| 2030   | HYDRAZINE, AQUEOUS SOLUTION with more than 37% hydrazine, by mass                            | 8                 | 6.1                  | II             | –                                      | 1 L                                      | E0                  | P001          | –                  | IBC02         | –             |
| 2030   | HYDRAZINE, AQUEOUS SOLUTION with more than 37% hydrazine, by mass                            | 8                 | 6.1                  | III            | –                                      | 5 L                                      | E1                  | P001<br>LP01  | –                  | IBC03         | –             |
| 2031   | NITRIC ACID other than red fuming, with more than 70% nitric acid                            | 8                 | 5.1                  | I              | –                                      | 0  | E0                  | P001          | PP81               | –             | –             |
| 2031   | NITRIC ACID other than red fuming, with at least 65% but with not more than 70% nitric acid  | 8                 | 5.1                  | II             | –                                      | 1 L                                      | E2                  | P001          | PP81               | IBC02         | B15<br>B20    |
| 2031   | NITRIC ACID other than red fuming, with less than 65% nitric acid                            | 8                 | –                    | II             | –                                      | 1 L                                      | E2                  | P001          | PP81               | IBC02         | B15<br>B20    |
| 2032   | NITRIC ACID, RED FUMING  | 8                 | 5.1/6.1              | I              | –                                      | 0  | E0                  | P602          | –                  | –             | –             |
| 2033   | POTASSIUM MONOXIDE   | 8                 | –                    | II             | –                                      | 1 kg                                     | E2                  | P002          | –                  | IBC08         | B4<br>B21     |
| 2034   | HYDROGEN AND METHANE MIXTURE, COMPRESSED   | 2.1               | –                    | –              | –                                      | 0  | E0                  | P200          | –                  | –             | –             |
| 2035   | 1,1,1-TRIFLUOROETHANE (REFRIGERANT GAS R 143a)   | 2.1               | –                    | –              | –                                      | 0  | E0                  | P200          | –                  | –             | –             |
| 2036   | XENON  | 2.2               | –                    | –              | 378<br>392                             | 120 mL                                   | E1                  | P200          | –                  | –             | –             |
| 2037   | RECEPTACLES, SMALL, CONTAINING GAS (GAS CARTRIDGES) without a release device, non-refillable | 2                 | –                    | –              | 191<br>277<br>303<br>327<br>344<br>959 | see<br>SP277                             | E0                  | P003<br>LP200 | PP17<br>PP96<br>L2 | –             | –             |
| 2038   | DINITROTOLUENES, LIQUID  | 6.1               | –<br>P               | II             | –                                      | 100 mL                                   | E4                  | P001          | –                  | IBC02         | B20           |
| 2044   | 2,2-DIMETHYLPROPANE  | 2.1               | –                    | –              | –                                      | 0  | E0                  | P200          | –                  | –             | –             |

| UN No. | Portable tanks and bulk containers |               | EmS                    | Stowage and handling      | Segregation   | Properties and observations  | UN No. |
|--------|------------------------------------|---------------|------------------------|---------------------------|---|--|--------|
|        | Tank instructions                  | Provisions    |                        |                           |   |  |        |
| (12)   | (13)<br>4.2.5<br>4.3               | (14)<br>4.2.5 | (15)<br>5.4.3.4<br>7.8 | (16a)<br>7.1<br>7.3–7.7   | (16b)<br>7.2–7.7                                    | (17)   | (18)   |
| –      | T10                                | TP2<br>TP13   | F-A, S-B               | Category D<br>SW2         | SGG18<br>SG35                                       | Colourless liquid. Powerful reducing agent, burns readily. Toxic if swallowed, by skin contact or by inhalation. Causes burns to skin, eyes and mucous membranes. Reacts violently with acids.   | 2030   |
| –      | T7                                 | TP2<br>TP13   | F-A, S-B               | Category D<br>SW2         | SGG18<br>SG35                                       | See entry above.   | 2030   |
| –      | T4                                 | TP1           | F-A, S-B               | Category D<br>SW2         | SGG18<br>SG35                                       | See entry above.   | 2030   |
| –      | T10                                | TP2<br>TP13   | F-A, S-Q               | Category D                | SGG1<br>SG6<br>SG16<br>SG17<br>SG19<br>SG36<br>SG49 | Colourless liquid. Powerful oxidant; may cause fire in contact with organic materials such as wood, cotton or straw, evolving highly toxic gases (brown fumes). Highly corrosive to most metals. Causes severe burns to skin, eyes and mucous membranes.                         | 2031   |
| –      | T8                                 | TP2           | F-A, S-Q               | Category D                | SGG1<br>SG6<br>SG16<br>SG17<br>SG19<br>SG36<br>SG49 | Colourless liquid. Oxidant; may cause fire in contact with organic materials such as wood, cotton or straw, evolving highly toxic gases (brown fumes). Highly corrosive to most metals. Causes severe burns to skin, eyes and mucous membranes.                                  | 2031   |
| –      | T8                                 | TP2           | F-A, S-B               | Category D                | SGG1<br>SG36<br>SG49                                | See entry above.   | 2031   |
| –      | T20                                | TP2<br>TP13   | F-A, S-Q               | Category D<br>SW2         | SGG1<br>SG6<br>SG16<br>SG17<br>SG19<br>SG36<br>SG49 | Brown liquid. Powerful oxidant; may cause fire in contact with organic materials such as wood, cotton or straw. Highly corrosive to most metals. Toxic if swallowed, by skin contact or by vapour inhalation. Causes severe burns to skin, eyes and mucous membranes.            | 2032   |
| –      | T3                                 | TP33          | F-A, S-B               | Category A                | SGG18<br>SG22<br>SG35                               | Deliquescent crystalline solid. Reacts violently with water, generating heat. Reacts with ammonium salts, evolving ammonia gas. Reacts violently with acids. In the presence of moisture, corrosive to aluminium, zinc and tin. Causes burns to skin, eyes and mucous membranes. | 2033   |
| –      | –                                  | –             | F-D, S-U               | Category E<br>SW2         | SG46  | Flammable, odourless gas mixtures. Much lighter than air.  | 2034   |
| –      | T50                                | –             | F-D, S-U               | Category B<br>SW2         | –   | Flammable gas with a slight odour. Much heavier than air (2.9).  | 2035   |
| –      | –                                  | –             | F-C, S-V               | Category A                | –   | Liquefied, inert gas. Much heavier than air (4.5).   | 2036   |
| –      | –                                  | –             | F-D, S-U               | Category B<br>SW2<br>SW22 | –   | Normally contain mixtures of liquefied butane and propane in various proportions for use in camping stoves, etc.   | 2037   |
| –      | T7                                 | TP2           | F-A, S-A               | Category A                | –   | Immiscible with water. A commercial grade consisting of a mixture of the 2,4-, 3,4- and 3,5-isomers is an oily liquid. Toxic if swallowed, by skin contact or by inhalation.   | 2038   |
| –      | –                                  | –             | F-D, S-U               | Category E<br>SW2         | –   | Flammable hydrocarbon gas. Explosive limits: 1.4% to 7.2%. Heavier than air (2.48).  | 2044   |



Part 3 – Dangerous Goods List, special provisions and exceptions

Chapter 3.2 – Dangerous Goods List

| UN No. | Proper shipping name (PSN)  | Class or division | Subsidiary hazard(s) | Packing group  | Special provisions | Limited and excepted quantity provisions |                     | Packing      |              | IBC           |               |
|--------|---|-------------------|----------------------|----------------|--------------------|--|---------------------|--------------|--------------|---------------|---------------|
|        |   |                   |                      |                |                    | Limited quantities                       | Excepted quantities | Instructions | Provisions   | Instructions  | Provisions    |
| (1)    | (2)<br>3.1.2  | (3)<br>2.0        | (4)<br>2.0           | (5)<br>2.0.1.3 | (6)<br>3.3         | (7a)<br>3.4                              | (7b)<br>3.5         | (8)<br>4.1.4 | (9)<br>4.1.4 | (10)<br>4.1.4 | (11)<br>4.1.4 |
| 2045   | ISOBUTYL ALDEHYDE (ISOBUTYRALDEHYDE)  | 3                 | –                    | II             | –                  | 1 L                                      | E2                  | P001         | –            | IBC02         | –             |
| 2046   | CYMENES   | 3                 | –<br>P               | III            | –                  | 5 L                                      | E1                  | P001<br>LP01 | –            | IBC03         | –             |
| 2047   | DICHLOROPROPENES  | 3                 | –                    | II             | –                  | 1 L                                      | E2                  | P001         | –            | IBC02         | –             |
| 2047   | DICHLOROPROPENES  | 3                 | –                    | III            | 223                | 5 L                                      | E1                  | P001<br>LP01 | –            | IBC03         | –             |
| 2048   | DICYCLOPENTADIENE   | 3                 | –                    | III            | –                  | 5 L                                      | E1                  | P001<br>LP01 | –            | IBC03         | –             |
| 2049   | DIETHYLBENZENE  | 3                 | –                    | III            | –                  | 5 L                                      | E1                  | P001<br>LP01 | –            | IBC03         | –             |
| 2050   | DIISOBUTYLENES, ISOMERIC COMPOUNDS  | 3                 | –                    | II             | –                  | 1 L                                      | E2                  | P001         | –            | IBC02         | –             |
| 2051   | 2-DIMETHYLAMINOETHANOL  | 8                 | 3                    | II             | –                  | 1 L                                      | E2                  | P001         | –            | IBC02         | –             |
| 2052   | DIPENTENE   | 3                 | –<br>P               | III            | –                  | 5 L                                      | E1                  | P001<br>LP01 | –            | IBC03         | –             |
| 2053   | METHYL ISOBUTYL CARBINOL  | 3                 | –                    | III            | –                  | 5 L                                      | E1                  | P001<br>LP01 | –            | IBC03         | –             |
| 2054   | MORPHOLINE  | 8                 | 3                    | I              | –                  | 0  | E0                  | P001         | –            | –             | –             |
| 2055   | STYRENE MONOMER, STABILIZED   | 3                 | –                    | III            | 386                | 5 L                                      | E1                  | P001         | –            | IBC03         | –             |
| 2056   | TETRAHYDROFURAN   | 3                 | –                    | II             | –                  | 1 L                                      | E2                  | P001         | –            | IBC02         | –             |
| 2057   | TRIPROPYLENE  | 3                 | –<br>P               | II             | –                  | 1 L                                      | E2                  | P001         | –            | IBC02         | –             |
| 2057   | TRIPROPYLENE  | 3                 | –<br>P               | III            | 223                | 5 L                                      | E1                  | P001<br>LP01 | –            | IBC03         | –             |
| 2058   | VALERALDEHYDE   | 3                 | –                    | II             | –                  | 1 L                                      | E2                  | P001         | –            | IBC02         | –             |
| △ 2059 | NITROCELLULOSE SOLUTION, FLAMMABLE with not more than 12.6% nitrogen, by dry mass, and not more than 55% nitrocellulose | 3                 | –                    | I              | 28<br>198          | 0  | E0                  | P001         | –            | –             | –             |
| △ 2059 | NITROCELLULOSE SOLUTION, FLAMMABLE with not more than 12.6% nitrogen, by dry mass, and not more than 55% nitrocellulose | 3                 | –                    | II             | 28<br>198          | 1 L                                      | E0                  | P001         | –            | IBC02         | –             |
| △ 2059 | NITROCELLULOSE SOLUTION, FLAMMABLE with not more than 12.6% nitrogen, by dry mass, and not more than 55% nitrocellulose | 3                 | –                    | III            | 28<br>198<br>223   | 5 L                                      | E0                  | P001<br>LP01 | –            | IBC03         | –             |

| UN No. | Portable tanks and bulk containers |                    | EmS                    | Stowage and handling    | Segregation      | Properties and observations   | UN No. |
|--------|------------------------------------|--------------------|------------------------|-------------------------|------------------|---|--------|
|        | Tank instructions                  | Provisions         |                        |                         |                  |   |        |
| (12)   | (13)<br>4.2.5<br>4.3               | (14)<br>4.2.5      | (15)<br>5.4.3.4<br>7.8 | (16a)<br>7.1<br>7.3–7.7 | (16b)<br>7.2–7.7 | (17)  | (18)   |
| –      | T4                                 | TP1                | F-E, S-D               | Category E<br>SW2       | –                | Colourless liquid with a characteristic pungent odour. Flashpoint: –24°C c.c. Explosive limits: 1% to 12%. Immiscible with water.   | 2045   |
| –      | T2                                 | TP1                | F-E, S-D               | Category A              | –                | Colourless liquids with an aromatic odour. Immiscible with water. Explosive limits: 0.7% to 5.6%.   | 2046   |
| –      | T4                                 | TP1                | F-E, S-D               | Category B              | –                | Colourless or yellow liquids with a sweet odour. Explosive limits: 5% to 14%. Immiscible with water. Irritating to skin, eyes and mucous membranes.   | 2047   |
| –      | T2                                 | TP1                | F-E, S-D               | Category A              | –                | See entry above.  | 2047   |
| –      | T2                                 | TP1                | F-E, S-D               | Category A              | –                | The pure substance is a solid with a melting point of 34°C. Flashpoint: 26°C to 38°C o.c. Commercial products are liquids. Immiscible with water. Harmful if swallowed.                                 | 2048   |
| –      | T2                                 | TP1                | F-E, S-D               | Category A              | –                | Colourless liquids. Flashpoint: 49°C to 56°C c.c. Immiscible with water. The commercial product is a mixture of isomers.  | 2049   |
| –      | T4                                 | TP1                | F-E, S-D               | Category B              | –                | Colourless liquids. Flashpoint: –18°C to 21°C c.c. Explosive limits: 0.8% to 4.8%. Immiscible with water.   | 2050   |
| –      | T7                                 | TP2                | F-E, S-C               | Category A              | SG35             | Colourless, flammable liquid with a fishy odour. Flashpoint: 31°C o.c. Miscible with water. Causes burns to skin, eyes and mucous membranes.  | 2051   |
| –      | T2                                 | TP1                | F-E, S-E               | Category A              | –                | Colourless liquid with a lemon-like odour. Flashpoint: 43°C c.c. Explosive limits: 0.7% to 6.1%. Immiscible with water.   | 2052   |
| –      | T2                                 | TP1                | F-E, S-D               | Category A              | –                | Colourless liquid. Flashpoint: 41°C c.c. Explosive limits: 1% to 5.5%. Miscible with water. Harmful by inhalation.  | 2053   |
| –      | T10                                | TP2                | F-E, S-C               | Category A              | –                | Colourless liquid with a fishy odour. Flashpoint: 38°C o.c. Explosive limits: 2% to 11.2%. Miscible with water. Harmful by skin contact or by inhalation. Corrosive to skin, eyes and mucous membranes. | 2054   |
| –      | T2                                 | TP1                | F-E, S-D               | Category C<br>SW1       | –                | Colourless, oily liquid. Flashpoint: 32°C c.c. Explosive limits: 1.1% to 6.1%. Immiscible with water. Irritating to skin, eyes and mucous membranes.  | 2055   |
| –      | T4                                 | TP1                | F-E, S-D               | Category B              | –                | Colourless liquid with an ethereal odour. Flashpoint: below –18°C c.c. Explosive limits: 1.5% to 12%. Miscible with water.  | 2056   |
| –      | T4                                 | TP2                | F-E, S-D               | Category B              | –                | Colourless liquid. Immiscible with water.   | 2057   |
| –      | T2                                 | TP2                | F-E, S-D               | Category A              | –                | See entry above.  | 2057   |
| –      | T4                                 | TP1                | F-E, S-D               | Category B              | –                | Colourless liquid. Flashpoint: 12°C c.c. Partially miscible with water. Irritating to skin, eyes and mucous membranes.  | 2058   |
| –      | T11                                | TP1<br>TP8<br>TP27 | F-E, S-D               | Category E              | –                | When involved in a fire, evolves toxic nitrous fumes.   | 2059 △ |
| –      | T4                                 | TP1<br>TP8         | F-E, S-D               | Category B              | –                | See entry above.  | 2059 △ |
| –      | T2                                 | TP1                | F-E, S-D               | Category A              | –                | See entry above.  | 2059 △ |

Part 3 – Dangerous Goods List, special provisions and exceptions

Chapter 3.2 – Dangerous Goods List

| UN No. | Proper shipping name (PSN)  | Class or division | Subsidiary hazard(s) | Packing group  | Special provisions       | Limited and excepted quantity provisions |                     | Packing      |              | IBC           |               |
|--------|---|-------------------|----------------------|----------------|--------------------------|--|---------------------|--------------|--------------|---------------|---------------|
|        |   |                   |                      |                |                          | Limited quantities                       | Excepted quantities | Instructions | Provisions   | Instructions  | Provisions    |
| (1)    | (2)<br>3.1.2  | (3)<br>2.0        | (4)<br>2.0           | (5)<br>2.0.1.3 | (6)<br>3.3               | (7a)<br>3.4                              | (7b)<br>3.5         | (8)<br>4.1.4 | (9)<br>4.1.4 | (10)<br>4.1.4 | (11)<br>4.1.4 |
| 2067   | AMMONIUM NITRATE BASED FERTILIZER   | 5.1               | –                    | III            | 306<br>307<br>900<br>967 | 5 kg                                     | E1                  | P002<br>LP02 | –            | IBC08         | B3            |
| 2071   | AMMONIUM NITRATE BASED FERTILIZER   | 9                 | –                    | III            | 193                      | 5 kg                                     | E1                  | P002<br>LP02 | –            | IBC08         | B3            |
| 2073   | AMMONIA SOLUTION, relative density less than 0.880 at 15°C in water, with more than 35% but not more than 50% ammonia | 2.2               | –<br>P               | –              | –                        | 120 mL                                   | E0                  | P200         | –            | –             | –             |
| 2074   | ACRYLAMIDE, SOLID   | 6.1               | –                    | III            | –                        | 5 kg                                     | E1                  | P002<br>LP02 | –            | IBC08         | B3            |
| 2075   | CHLORAL, ANHYDROUS, STABILIZED  | 6.1               | –                    | II             | –                        | 100 mL                                   | E4                  | P001         | –            | IBC02         | –             |
| 2076   | CRESOLS, LIQUID   | 6.1               | 8                    | II             | –                        | 100 mL                                   | E4                  | P001         | –            | IBC02         | –             |
| 2077   | alpha-NAPHTHYLAMINE   | 6.1               | –                    | III            | –                        | 5 kg                                     | E1                  | P002<br>LP02 | –            | IBC08         | B3            |
| 2078   | TOLUENE DIISOCYANATE  | 6.1               | –                    | II             | 279                      | 100 mL                                   | E4                  | P001         | –            | IBC02         | –             |
| 2079   | DIETHYLENTRIAMINE   | 8                 | –                    | II             | –                        | 1 L                                      | E2                  | P001         | –            | IBC02         | –             |
| 2186   | HYDROGEN CHLORIDE, REFRIGERATED LIQUID  | 2.3               | 8                    | –              | 900                      | –  | –                   | –            | –            | –             | –             |
| 2187   | CARBON DIOXIDE, REFRIGERATED LIQUID   | 2.2               | –                    | –              | –                        | 120 mL                                   | E1                  | P203         | –            | –             | –             |
| 2188   | ARSINE  | 2.3               | 2.1                  | –              | –                        | 0  | E0                  | P200         | –            | –             | –             |
| 2189   | DICHLOROSILANE  | 2.3               | 2.1/8                | –              | –                        | 0  | E0                  | P200         | –            | –             | –             |
| 2190   | OXYGEN DIFLUORIDE, COMPRESSED   | 2.3               | 5.1/8                | –              | –                        | 0  | E0                  | P200         | –            | –             | –             |

| UN No. | Portable tanks and bulk containers |               | EmS                    | Stowage and handling              | Segregation  | Properties and observations   | UN No. |
|--------|------------------------------------|---------------|------------------------|-----------------------------------|--|---|--------|
|        | Tank instructions                  | Provisions    |                        |                                   |  |   |        |
| (12)   | (13)<br>4.2.5<br>4.3               | (14)<br>4.2.5 | (15)<br>5.4.3.4<br>7.8 | (16a)<br>7.1<br>7.3–7.7           | (16b)<br>7.2–7.7   | (17)  | (18)   |
| –      | T1<br>BK2<br>BK3                   | TP33          | F-H, S-Q               | Category C<br>SW1<br>SW14<br>SW23 | SGG2<br>SG16<br>SG42<br>SG45<br>SG47<br>SG48<br>SG51<br>SG56<br>SG58<br>SG59<br>SG61 | Crystals, granules or prills. Wholly or partly soluble in water. Supporters of combustion. A major fire aboard a ship carrying these substances may involve a risk of explosion in the event of contamination (e.g. by fuel oil) or strong confinement. An adjacent detonation may also involve a risk of explosion. If heated strongly, decompose, giving off toxic gases and gases which support combustion. Transport of AMMONIUM NITRATE liable to self-heating sufficient to initiate decomposition is prohibited. | 2067   |
| –      | BK2                                | –             | F-H, S-Q               | Category A<br>SW26                | SGG2   | Usually granules. Wholly or partly soluble in water. These mixtures may be subject to self-sustaining decomposition if heated. The temperature in such a reaction can reach 500°C. Decomposition, once initiated, may spread throughout the remainder, producing gases which are toxic. None of these mixtures is subject to the explosion hazard. Transport of AMMONIUM NITRATE liable to self-heating sufficient to initiate decomposition is prohibited.   | 2071   |
| –      | –                                  | –             | F-C, S-U               | Category E<br>SW2                 | SGG2<br>SGG18<br>SG35<br>SG46  | Solution in water of non-flammable gas with a pungent odour. Reacts violently with acids. Extremely dangerous to the eyes.  | 2073   |
| –      | T1                                 | TP33          | F-A, S-A               | Category A<br>SW1<br>H2           | –  | Crystals or powder. Soluble in water. May polymerise violently on melting. Toxic if swallowed, by skin contact or by inhalation.  | 2074   |
| –      | T7                                 | TP2           | F-A, S-A               | Category D<br>SW2                 | –  | Colourless, mobile liquid, evolving toxic vapours which are considerably heavier than air. Toxic if swallowed, by skin contact or by inhalation.  | 2075   |
| –      | T7                                 | TP2           | F-A, S-B               | Category B                        | –  | Colourless to light yellow liquids. Miscible with water. Melting point of meta-CRESOL: 12°C. Toxic if swallowed, by skin contact or by inhalation. Cause burns to skin, eyes and mucous membranes.  | 2076   |
| –      | T1                                 | TP33          | F-A, S-A               | Category A                        | –  | White crystals. Toxic if swallowed, by skin contact or by inhalation.   | 2077   |
| –      | T7                                 | TP2<br>TP13   | F-A, S-A               | Category C<br>SW1<br>SW2          | –  | Colourless to pale yellow liquid with a pungent odour. Immiscible with water but reacts with it to form carbon dioxide. Melting point: 20°C (pure product). Toxic if swallowed, by skin contact or by inhalation. Irritating to skin, eyes and mucous membranes.  | 2078   |
| –      | T7                                 | TP2           | F-A, S-B               | Category A<br>SW2                 | SGG18<br>SG35  | Yellow hygroscopic liquid with ammoniacal odour. Soluble in water. Strongly alkaline, corrosive. Can form explosive mixtures with nitric acid. Reacts with oxidizing substances. Corrosive to copper and its alloys. Reacts violently with acids. Liquid and vapour can cause severe damage to skin and eyes.   | 2079   |
| –      | –                                  | –             | –                      | –                                 | –  | Transport is prohibited.  | 2186   |
| –      | T75                                | TP5           | F-C, S-V               | Category D                        | –  | Non-flammable, liquefied gas, colourless and odourless. Heavier than air (1.5). Cannot remain in the liquid state above 31°C.   | 2187   |
| –      | –                                  | –             | F-D, S-U               | Category D<br>SW2                 | –  | Flammable, toxic, colourless gas with a garlic odour. Explosive limits: 3.9% to 77.8%. Much heavier than air (2.8).   | 2188   |
| –      | –                                  | –             | F-D, S-U               | Category D<br>SW2                 | SG4<br>SG9<br>SG72   | Flammable, toxic and corrosive gas. Reacts with water, evolving hydrogen chloride. Highly irritating to skin, eyes and mucous membranes.  | 2189   |
| –      | –                                  | –             | F-C, S-W               | Category D<br>SW2<br>H1           | SG6<br>SG19  | Non-flammable, toxic and corrosive, colourless gas with a foul odour. Strong oxidizing agent. Reacts slowly with water or moist air to produce poisonous and corrosive fumes. Corrosive to glass and to most metals. Heavier than air (1.9). Highly irritating to skin, eyes and mucous membranes.  | 2190   |

Part 3 – Dangerous Goods List, special provisions and exceptions

Chapter 3.2 – Dangerous Goods List

| UN No. | Proper shipping name (PSN)                                       | Class or division | Subsidiary hazard(s) | Packing group  | Special provisions | Limited and excepted quantity provisions |                          | Packing          |                | IBC               |                 |
|--------|--|-------------------|----------------------|----------------|--------------------|--|--------------------------|------------------|----------------|-------------------|-----------------|
|        |  |                   |                      |                |                    | Limited quantities (7a)                  | Excepted quantities (7b) | Instructions (8) | Provisions (9) | Instructions (10) | Provisions (11) |
| (1)    | (2)<br>3.1.2   | (3)<br>2.0        | (4)<br>2.0           | (5)<br>2.0.1.3 | (6)<br>3.3         | (7a)<br>3.4                              | (7b)<br>3.5              | (8)<br>4.1.4     | (9)<br>4.1.4   | (10)<br>4.1.4     | (11)<br>4.1.4   |
| 2191   | SULPHURYL FLUORIDE   | 2.3               | –                    | –              | –                  | 0  | E0                       | P200             | –              | –                 | –               |
| 2192   | GERMANE  | 2.3               | 2.1                  | –              | –                  | 0  | E0                       | P200             | –              | –                 | –               |
| 2193   | HEXAFLUOROETHANE (REFRIGERANT GAS R 116)                         | 2.2               | –                    | –              | –                  | 120 mL                                   | E1                       | P200             | –              | –                 | –               |
| 2194   | SELENIUM HEXAFLUORIDE  | 2.3               | 8                    | –              | –                  | 0  | E0                       | P200             | –              | –                 | –               |
| 2195   | TELLURIUM HEXAFLUORIDE   | 2.3               | 8                    | –              | –                  | 0  | E0                       | P200             | –              | –                 | –               |
| 2196   | TUNGSTEN HEXAFLUORIDE  | 2.3               | 8                    | –              | –                  | 0  | E0                       | P200             | –              | –                 | –               |
| 2197   | HYDROGEN IODIDE, ANHYDROUS                                       | 2.3               | 8                    | –              | –                  | 0  | E0                       | P200             | –              | –                 | –               |
| 2198   | PHOSPHORUS PENTAFLUORIDE   | 2.3               | 8                    | –              | –                  | 0  | E0                       | P200             | –              | –                 | –               |
| 2199   | PHOSPHINE  | 2.3               | 2.1                  | –              | –                  | 0  | E0                       | P200             | –              | –                 | –               |
| 2200   | PROPADIENE, STABILIZED   | 2.1               | –                    | –              | 386                | 0  | E0                       | P200             | –              | –                 | –               |
| 2201   | NITROUS OXIDE, REFRIGERATED LIQUID                               | 2.2               | 5.1                  | –              | –                  | 0  | E0                       | P203             | –              | –                 | –               |
| 2202   | HYDROGEN SELENIDE, ANHYDROUS                                     | 2.3               | 2.1                  | –              | –                  | 0  | E0                       | P200             | –              | –                 | –               |
| 2203   | SILANE   | 2.1               | –                    | –              | –                  | 0  | E0                       | P200             | –              | –                 | –               |
| 2204   | CARBONYL SULPHIDE  | 2.3               | 2.1                  | –              | –                  | 0  | E0                       | P200             | –              | –                 | –               |
| 2205   | ADIPONITRILE   | 6.1               | –                    | III            | –                  | 5 L                                      | E1                       | P001 LP01        | –              | IBC03             | –               |
| 2206   | ISOCYANATES, TOXIC, N.O.S. or ISOCYANATE SOLUTION, TOXIC, N.O.S. | 6.1               | –                    | II             | 274                | 100 mL                                   | E4                       | P001             | –              | IBC02             | –               |

| UN No. | Portable tanks and bulk containers |                 | EmS                    | Stowage and handling    | Segregation      | Properties and observations  | UN No. |
|--------|------------------------------------|-----------------|------------------------|-------------------------|------------------|--|--------|
|        | Tank instructions (12)             | Provisions (14) |                        |                         |                  |  |        |
| (12)   | (13)<br>4.2.5<br>4.3               | (14)<br>4.2.5   | (15)<br>5.4.3.4<br>7.8 | (16a)<br>7.1<br>7.3–7.7 | (16b)<br>7.2–7.7 | (17)   | (18)   |
| –      | –                                  | –               | F-C, S-U               | Category D SW2          | –                | Non-flammable, toxic, colourless, odourless gas. Reacts with water or moist air to produce toxic and corrosive fumes. Much heavier than air (3.5). Irritating to skin, eyes and mucous membranes.  | 2191   |
| –      | –                                  | –               | F-D, S-U               | Category D SW2          | –                | Flammable, toxic, colourless gas with a pungent odour. Much heavier than air (2.6).  | 2192   |
| –      | –                                  | –               | F-C, S-V               | Category A              | –                | Non-flammable, colourless and odourless gas. Much heavier than air (4.8). Cannot remain in liquid state above 24.3°C.  | 2193   |
| –      | –                                  | –               | F-C, S-U               | Category D SW2          | –                | Colourless, toxic and corrosive gas. Corrosive to glass and to most metals. Heavier than air. Highly irritating to skin, eyes and mucous membranes.  | 2194   |
| –      | –                                  | –               | F-C, S-U               | Category D SW2          | –                | Non-flammable, toxic and corrosive colourless gas with an unpleasant odour. Decomposes in water, evolving highly toxic and corrosive fumes. Corrosive to glass and to most metals. Much heavier than air (7.2). Highly irritating to skin, eyes and mucous membranes.  | 2195   |
| –      | –                                  | –               | F-C, S-U               | Category D SW2          | –                | Non-flammable, toxic and corrosive, colourless gas, or yellow liquid. Decomposes in water or moist air, evolving highly toxic and corrosive fumes. Corrosive to glass and to most metals. Much heavier than air (10.3). Boiling point: 19.5°C. Highly irritating to skin, eyes and mucous membranes.   | 2196   |
| –      | –                                  | –               | F-C, S-U               | Category D SW2          | –                | Non-flammable, toxic and corrosive colourless gas with a pungent odour. Highly corrosive in the presence of water. Much heavier than air (4.4). Highly irritating to skin, eyes and mucous membranes.  | 2197   |
| –      | –                                  | –               | F-C, S-U               | Category D SW2          | –                | Non-flammable, toxic and corrosive gas with an irritating odour. Reacts with water or moist air to produce toxic and corrosive fumes. Corrosive to glass and to most metals. Much heavier than air (4.3). Highly irritating to skin, eyes and mucous membranes.  | 2198   |
| –      | –                                  | –               | F-D, S-U               | Category D SW2          | –                | Flammable, toxic, colourless gas with a garlic odour. Ignites spontaneously in air. Heavier than air (1.2). Irritating to skin, eyes and mucous membranes.   | 2199   |
| –      | –                                  | –               | F-D, S-U               | Category B SW1 SW2      | –                | Liquefied, flammable, colourless gas. Explosive limits: 1.7% to 12%. Heavier than air (1.4). Boiling point: –34°C. Irritating to skin, eyes and mucous membranes.  | 2200   |
| –      | T75                                | TP5 TP22        | F-C, S-W               | Category D SW2          | –                | Liquefied, non-flammable, colourless gas with a slightly sweet odour. Strong oxidizing agent. Heavier than air (1.5). Cannot remain in liquid state above 36.5°C.  | 2201   |
| –      | –                                  | –               | F-D, S-U               | Category D SW2          | –                | Flammable, toxic, colourless gas with a disagreeable odour. Much heavier than air (2.8). Highly irritating to skin, eyes and mucous membranes.   | 2202   |
| –      | –                                  | –               | F-D, S-U               | Category E SW2          | SG43 SG46        | Flammable, colourless gas with a foul odour. Explosive limits: 1% to 100%. Ignites spontaneously in air. Strong reducing agent which reacts violently with oxidizing substances. Heavier than air (1.1).   | 2203   |
| –      | –                                  | –               | F-D, S-U               | Category D SW2          | –                | Flammable, toxic, colourless gas with a foul odour. Much heavier than air (2.1).   | 2204   |
| –      | T3                                 | TP1             | F-A, S-A               | Category A              | SGG6             | Colourless, odourless oil. Decomposes above 93°C, evolving hydrogen cyanide, a highly toxic and flammable gas. Toxic if swallowed, by skin contact or by inhalation.   | 2205   |
| –      | T11                                | TP2 TP13 TP27   | F-A, S-A               | Category E SW1 SW2      | –                | Liquids with a pungent odour. Immiscible with water but react with it to form carbon dioxide. Toxic if swallowed, by skin contact or by inhalation. If under deck, with mechanical ventilation, six air changes per hour, except when carried in closed containers, when two air changes per hour are required. Irritating to skin, eyes and mucous membranes. | 2206   |



Part 3 – Dangerous Goods List, special provisions and exceptions

Chapter 3.2 – Dangerous Goods List

| UN No. | Proper shipping name (PSN)  | Class or division | Subsidiary hazard(s) | Packing group  | Special provisions | Limited and excepted quantity provisions |                     | Packing      |              | IBC           |               |
|--------|---|-------------------|----------------------|----------------|--------------------|--|---------------------|--------------|--------------|---------------|---------------|
|        |   |                   |                      |                |                    | Limited quantities                       | Excepted quantities | Instructions | Provisions   | Instructions  | Provisions    |
| (1)    | (2)<br>3.1.2  | (3)<br>2.0        | (4)<br>2.0           | (5)<br>2.0.1.3 | (6)<br>3.3         | (7a)<br>3.4                              | (7b)<br>3.5         | (8)<br>4.1.4 | (9)<br>4.1.4 | (10)<br>4.1.4 | (11)<br>4.1.4 |
| 2206   | ISOCYANATES, TOXIC, N.O.S. or ISOCYANATE SOLUTION, TOXIC, N.O.S.                              | 6.1               | –                    | III            | 223<br>274         | 5 L                                      | E1                  | P001<br>LP01 | –            | IBC03         | –             |
| 2208   | CALCIUM HYPOCHLORITE MIXTURE, DRY with more than 10% but not more than 39% available chlorine | 5.1               | –<br>P               | III            | 314                | 5 kg                                     | E1                  | P002         | PP85         | –             | –             |
| 2209   | FORMALDEHYDE SOLUTION with not less than 25% formaldehyde                                     | 8                 | –                    | III            | –                  | 5 L                                      | E1                  | P001<br>LP01 | –            | IBC03         | –             |
| 2210   | MANEB or MANEB PREPARATION with not less than 60% maneb                                       | 4.2               | 4.3<br>P             | III            | 273                | 0  | E1                  | P002         | PP100        | IBC06         | –             |
| 2211   | POLYMERIC BEADS, EXPANDABLE, evolving flammable vapour  | 9                 | –                    | III            | 382<br>965         | 5 kg                                     | E1                  | P002         | PP14         | IBC08         | B3<br>B6      |
| 2212   | ASBESTOS, AMPHIBOLE (amosite, tremolite, actinolite, anthophyllite, crocidolite)              | 9                 | –                    | II             | 168<br>274         | 1 kg                                     | E0                  | P002         | PP37         | IBC08         | B4<br>B21     |
| 2213   | PARAFORMALDEHYDE  | 4.1               | –                    | III            | 223<br>967         | 5 kg                                     | E1                  | P002<br>LP02 | PP12         | IBC08         | B3            |
| 2214   | PHTHALIC ANHYDRIDE with more than 0.05% of maleic anhydride                                   | 8                 | –                    | III            | 169<br>939         | 5 kg                                     | E1                  | P002<br>LP02 | –            | IBC08         | B3            |
| 2215   | MALEIC ANHYDRIDE  | 8                 | –                    | III            | –                  | 5 kg                                     | E1                  | P002         | –            | IBC08         | B3            |

| UN No. | Portable tanks and bulk containers |                     | EmS                    | Stowage and handling      | Segregation                                  | Properties and observations   | UN No. |
|--------|------------------------------------|---------------------|------------------------|---------------------------|--|---|--------|
|        | Tank instructions                  | Provisions          |                        |                           |  |   |        |
| (12)   | (13)<br>4.2.5<br>4.3               | (14)<br>4.2.5       | (15)<br>5.4.3.4<br>7.8 | (16a)<br>7.1<br>7.3–7.7   | (16b)<br>7.2–7.7                             | (17)  | (18)   |
| –      | T7                                 | TP1<br>TP13<br>TP28 | F-A, S-A               | Category E<br>SW1<br>SW2  | –  | Liquids with a pungent odour. Immiscible with water but react with it to form carbon dioxide. Toxic if swallowed, by skin contact or by inhalation. If under deck, with mechanical ventilation, six air changes per hour, except when carried in closed containers, when two air changes per hour are required. Irritating to skin, eyes and mucous membranes.  | 2206   |
| –      | –                                  | –                   | F-H, S-Q               | Category D<br>SW1<br>SW11 | SGG8<br>SG35<br>SG38<br>SG49<br>SG53<br>SG60 | White or yellowish solid (powder, granules or tablets) with chlorine-like odour. Soluble in water. May cause fire in contact with organic material or ammonium compounds. Substances are liable to exothermic decomposition at elevated temperatures. This condition may lead to fire or explosion. Decomposition can be initiated by heat or by impurities (e.g. powdered metals (iron, manganese, cobalt, magnesium) and their compounds). Liable to heat slowly. Reacts with acids, evolving chlorine, an irritating, corrosive and toxic gas. In the presence of moisture, corrosive to most metals. Dust irritates mucous membranes.   | 2208   |
| –      | T4                                 | TP1                 | F-A, S-B               | Category A                | –  | Colourless, clear liquid, with a suffocating pungent odour. Usually stabilized with methyl alcohol. Miscible with water. Causes burns to skin, eyes and mucous membranes.   | 2209   |
| –      | T1                                 | TP33                | F-G, S-L               | Category A<br>H1          | SG26<br>SG29                                 | Yellow powder, liable to heat and to ignite spontaneously in air. May evolve toxic, irritating or flammable fumes when wet, when involved in a fire or in contact with acids. Used as fungicide.  | 2210   |
| –      | T1                                 | TP33                | F-A, S-I               | Category E<br>SW1<br>SW6  | SG5<br>SG14                                  | A moulding material in bead or granular form consisting predominantly of polystyrene, poly(methyl methacrylate) or other polymeric material and containing 5% to 8% of a volatile hydrocarbon which is predominantly pentane. During storage, a small proportion of this pentane is released to the atmosphere; this proportion increases at elevated temperatures.   | 2211   |
| –      | T3                                 | TP33                | F-A, S-A               | Category A<br>SW2<br>H4   | SG29   | Mineral fibres of varying length. Non-combustible. Inhalation of the dust of asbestos fibres is dangerous and therefore exposure should be avoided at all times. Always prevent the generation of asbestos dust. A safe level of airborne concentration of asbestos fibres may be obtained through effective packing. Cargo spaces or freight containers that have contained any type of raw asbestos should be carefully cleaned before discharging any remaining cargo, loading other cargo or carrying out repair or maintenance work. Whenever possible, cleaning of cargo spaces should be carried out whilst the ship is in a port where proper facilities and equipment, including proper respiratory apparatus and protective clothing, is available. Parts of the body that may have been exposed should be immediately and thoroughly washed. All waste material should be collected in impermeable and sealed bags for safe disposal ashore. If cleaning cannot be carried out at the discharge port, arrangements should be made in advance for cleaning to be carried out at the next port where necessary facilities are available. | 2212   |
| –      | T1<br>BK2<br>BK3                   | TP33                | F-A, S-G               | Category A<br>SW23        | –  | White powder with a pungent odour. Evolves formaldehyde, particularly when heated, which is irritating to eyes and mucous membranes.  | 2213   |
| –      | T1                                 | TP33                | F-A, S-B               | Category A                | SGG1<br>SG36<br>SG49                         | White powder or flakes and lumps containing a high proportion of dust. Melting point: 131°C. The vapour of the molten substance has a flashpoint of 152°C c.c. and forms a flammable atmosphere with explosive limits of 1.7% to 10.4%. Causes burns to skin, eyes and mucous membranes. May be carried in the molten state. The molten substance can cause severe skin burns.  | 2214   |
| –      | T1                                 | TP33                | F-A, S-B               | Category A                | SGG1<br>SG36<br>SG49<br>SG50<br>SG57         | White powder, needles, flakes, pellets, rods, briquettes, lumps or fused mass. Melting point: about 53°C. Fumes and dust are irritating to skin, eyes and mucous membranes. Inhalation can cause respiratory trouble.   | 2215   |

Part 3 – Dangerous Goods List, special provisions and exceptions

Chapter 3.2 – Dangerous Goods List

| UN No. | Proper shipping name (PSN)  | Class or division | Subsidiary hazard(s) | Packing group  | Special provisions                           | Limited and excepted quantity provisions |                          | Packing          |                | IBC               |                 |
|--------|---|-------------------|----------------------|----------------|--|--|--------------------------|------------------|----------------|-------------------|-----------------|
|        |   |                   |                      |                |  | Limited quantities (7a)                  | Excepted quantities (7b) | Instructions (8) | Provisions (9) | Instructions (10) | Provisions (11) |
| (1)    | (2)<br>3.1.2  | (3)<br>2.0        | (4)<br>2.0           | (5)<br>2.0.1.3 | (6)<br>3.3                                   | (7a)<br>3.4                              | (7b)<br>3.5              | (8)<br>4.1.4     | (9)<br>4.1.4   | (10)<br>4.1.4     | (11)<br>4.1.4   |
| 2215   | MALEIC ANHYDRIDE, MOLTEN  | 8                 | –                    | III            | –  | 0  | E0                       | –                | –              | –                 | –               |
| 2216   | FISH MEAL (FISH SCRAP), STABILIZED Anti-oxidant treated. Moisture content greater than 5% but not exceeding 12%, by mass. Fat content not more than 15% | 9                 | –                    | III            | 29<br>117<br>300<br>308<br>907<br>928<br>973 | 0  | E1                       | P900             | –              | IBC08             | B3              |
| 2217   | SEED CAKE with not more than 1.5% oil and not more than 11% moisture  | 4.2               | –                    | III            | 29<br>142<br>973                             | 0  | E0                       | P002<br>LP02     | PP20           | IBC08             | B3<br>B6        |
| 2218   | ACRYLIC ACID, STABILIZED  | 8                 | 3<br>P               | II             | 386  | 1 L                                      | E2                       | P001             | –              | IBC02             | –               |
| 2219   | ALLYL GLYCIDYL ETHER  | 3                 | –                    | III            | –  | 5 L                                      | E1                       | P001<br>LP01     | –              | IBC03             | –               |
| 2222   | ANISOLE   | 3                 | –                    | III            | –  | 5 L                                      | E1                       | P001<br>LP01     | –              | IBC03             | –               |
| 2224   | BENZONITRILE  | 6.1               | –                    | II             | –  | 100 mL                                   | E4                       | P001             | –              | IBC02             | –               |
| 2225   | BENZENESULPHONYL CHLORIDE   | 8                 | –                    | III            | –  | 5 L                                      | E1                       | P001<br>LP01     | –              | IBC03             | –               |
| 2226   | BENZOTRICHLORIDE  | 8                 | –                    | II             | –  | 1 L                                      | E2                       | P001             | –              | IBC02             | –               |
| 2227   | n-BUTYL METHACRYLATE, STABILIZED  | 3                 | –                    | III            | 386  | 5 L                                      | E1                       | P001<br>LP01     | –              | IBC03             | –               |
| 2232   | 2-CHLOROETHANAL   | 6.1               | –                    | I              | 354  | 0  | E0                       | P602             | –              | –                 | –               |
| 2233   | CHLOROANISIDINES  | 6.1               | –                    | III            | –  | 5 kg                                     | E1                       | P002<br>LP02     | –              | IBC08             | B3              |
| 2234   | CHLOROBENZOTRIFLUORIDES   | 3                 | –                    | III            | –  | 5 L                                      | E1                       | P001<br>LP01     | –              | IBC03             | –               |

| UN No. | Portable tanks and bulk containers |                 | EmS                    | Stowage and handling     | Segregation                          | Properties and observations  | UN No. |
|--------|------------------------------------|-----------------|------------------------|--------------------------|--------------------------------------|--|--------|
|        | Tank instructions (12)             | Provisions (14) |                        |                          |                                      |  |        |
| (18)   | (13)<br>4.2.5<br>4.3               | (14)<br>4.2.5   | (15)<br>5.4.3.4<br>7.8 | (16a)<br>7.1<br>7.3–7.7  | (16b)<br>7.2–7.7                     | (17)   | (18)   |
| 2215   | T4                                 | TP3             | F-A, S-B               | Category A               | SGG1<br>SG36<br>SG49<br>SG50<br>SG57 | Melting point: about 53°C. The vapour of the molten substance has a flashpoint of 103°C c.c. and forms a flammable atmosphere with explosive limits of 1.4% to 7.1%. Fumes are irritating to skin, eyes and mucous membranes.  | 2215   |
| 2216   | T1<br>BK2                          | TP33            | F-A, S-J               | Category B<br>SW24       | SG18<br>SG65                         | Brown to greenish-brown product obtained through heating and drying of oily fish. Strong odour which may affect other cargo. Liable to heat spontaneously unless of low fat content or effectively anti-oxidant treated.   | 2216   |
| 2217   | BK2                                | –               | F-A, S-J               | Category A<br>SW4<br>H1  | –                                    | Residue remaining after oil has been extracted by a solvent process from oil-bearing seeds. Used mainly as an animal feed or fertilizer. The most common seed cakes include those derived from coconut (copra), cottonseed, groundnut (peanut), linseed, maize (hominy chop), niger seed, palm kernel, rape seed, rice bran, soya bean and sunflower seed and they may be shipped in the form of cake, flakes, pellets, meal, etc. May self-heat slowly if wet and ignite spontaneously. Before shipment, this cargo should be properly aged. The duration of ageing varies with the oil content. The seed cake should be substantially free from flammable solvent. Smoking and the use of naked lights should not be allowed during loading and unloading, and on entry to cargo spaces at any other time. | 2217   |
| 2218   | T7                                 | TP2             | F-E, S-C               | Category C<br>SW1<br>SW2 | SGG1<br>SG36<br>SG49                 | Colourless, flammable liquid with an acrid odour. Melting point: 13°C. Flashpoint: 54°C o.c. Miscible with water. May polymerize violently, which may cause fire and explosion, unless properly stabilized. Harmful if swallowed or by inhalation. Corrosive to skin, eyes and mucous membranes.   | 2218   |
| 2219   | T2                                 | TP1             | F-E, S-D               | Category A               | –                                    | Colourless liquid. Flashpoint: 48°C c.c. Miscible with water. Harmful by inhalation. Irritating to skin, eyes and mucous membranes.  | 2219   |
| 2222   | T2                                 | TP1             | F-E, S-D               | Category A               | –                                    | Colourless to yellow liquid. Flashpoint: 41°C c.c. Explosive limits: 0.3% to 6.3%. Immiscible with water. Irritating to skin, eyes and mucous membranes.   | 2222   |
| 2224   | T7                                 | TP2             | F-A, S-A               | Category A<br>SW2        | SG35                                 | Colourless liquid with an odour similar to oil of bitter almonds. Reacts with acids, evolving hydrogen cyanide, a highly toxic and flammable gas. Toxic if swallowed, by skin contact or by inhalation.  | 2224   |
| 2225   | T4                                 | TP1             | F-A, S-B               | Category A<br>SW2        | SGG1                                 | Colourless to slightly yellow liquid with a pungent odour. Melting point: 12°C. Immiscible with water. Decomposes slowly in water. Harmful if swallowed or by skin contact. Highly irritating to skin, eyes and mucous membranes.  | 2225   |
| 2226   | T7                                 | TP2             | F-A, S-B               | Category A<br>SW2        | SGG1<br>SG36<br>SG49                 | Colourless to slightly yellow or brown fuming liquid. Reacts with water, evolving hydrogen chloride, an irritating and corrosive gas apparent as white fumes. In the presence of moisture, corrosive to most metals. Harmful if swallowed, by skin contact or by inhalation. Burns skin and eyes. Vapour irritates eyes and mucous membranes.  | 2226   |
| 2227   | T2                                 | TP1             | F-E, S-D               | Category C<br>SW1        | –                                    | Colourless liquid. Flashpoint: 41°C c.c. Explosive limits: 2% to 8%. Immiscible with water. Irritating to skin, eyes and mucous membranes.   | 2227   |
| 2232   | T20                                | TP2<br>TP13     | F-A, S-A               | Category D<br>SW2        | –                                    | Clear colourless liquid with a pungent odour. Miscible with water. Highly toxic if swallowed, by skin contact or by inhalation.  | 2232   |
| 2233   | T1                                 | TP33            | F-A, S-A               | Category A               | –                                    | Crystalline solid. Melting point: 52°C. Soluble in water. Toxic if swallowed, by skin contact or by dust inhalation.   | 2233   |
| 2234   | T2                                 | TP1             | F-E, S-D               | Category A<br>SW2        | SGG10                                | Colourless liquids with an aromatic odour. Flashpoint: 36°C to 59°C c.c. On contact with moisture, can evolve hydrogen fluoride, which is a toxic and corrosive gas. Harmful by inhalation.  | 2234   |

Part 3 – Dangerous Goods List, special provisions and exceptions

Chapter 3.2 – Dangerous Goods List

| UN No. | Proper shipping name (PSN)   | Class or division | Subsidiary hazard(s) | Packing group  | Special provisions | Limited and excepted quantity provisions |                     | Packing      |              | IBC           |               |
|--------|--|-------------------|----------------------|----------------|--------------------|--|---------------------|--------------|--------------|---------------|---------------|
|        |  |                   |                      |                |                    | Limited quantities                       | Excepted quantities | Instructions | Provisions   | Instructions  | Provisions    |
| (1)    | (2)<br>3.1.2   | (3)<br>2.0        | (4)<br>2.0           | (5)<br>2.0.1.3 | (6)<br>3.3         | (7a)<br>3.4                              | (7b)<br>3.5         | (8)<br>4.1.4 | (9)<br>4.1.4 | (10)<br>4.1.4 | (11)<br>4.1.4 |
| 2235   | CHLOROBENZYL CHLORIDES, LIQUID   | 6.1               | -<br>P               | III            | -                  | 5 L                                      | E1                  | P001<br>LP01 | -            | IBC03         | -             |
| 2236   | 3-CHLORO-4-METHYLPHENYL ISOCYANATE, LIQUID                                 | 6.1               | -                    | II             | -                  | 100 mL                                   | E4                  | P001         | -            | IBC02         | -             |
| 2237   | CHLORONITROANILINES  | 6.1               | -<br>P               | III            | -                  | 5 kg                                     | E1                  | P002<br>LP02 | -            | IBC08         | B3            |
| 2238   | CHLOROTOLUENES   | 3                 | -                    | III            | -                  | 5 L                                      | E1                  | P001<br>LP01 | -            | IBC03         | -             |
| 2239   | CHLOROTOLUIDINES, SOLID  | 6.1               | -                    | III            | -                  | 5 kg                                     | E1                  | P002<br>LP02 | -            | IBC08         | B3            |
| 2240   | CHROMOSULPHURIC ACID   | 8                 | -                    | I              | -                  | 0  | E0                  | P001         | -            | -             | -             |
| 2241   | CYCLOHEPTANE   | 3                 | -<br>P               | II             | -                  | 1 L                                      | E2                  | P001         | -            | IBC02         | -             |
| 2242   | CYCLOHEPTENE   | 3                 | -                    | II             | -                  | 1 L                                      | E2                  | P001         | -            | IBC02         | -             |
| 2243   | CYCLOHEXYL ACETATE   | 3                 | -                    | III            | -                  | 5 L                                      | E1                  | P001<br>LP01 | -            | IBC03         | -             |
| 2244   | CYCLOPENTANOL  | 3                 | -                    | III            | -                  | 5 L                                      | E1                  | P001<br>LP01 | -            | IBC03         | -             |
| 2245   | CYCLOPENTANONE   | 3                 | -                    | III            | -                  | 5 L                                      | E1                  | P001<br>LP01 | -            | IBC03         | -             |
| 2246   | CYCLOPENTENE   | 3                 | -                    | II             | -                  | 1 L                                      | E2                  | P001         | -            | IBC02         | B8            |
| 2247   | n-DECANE   | 3                 | -                    | III            | -                  | 5 L                                      | E1                  | P001<br>LP01 | -            | IBC03         | -             |
| 2248   | DI-n-BUTYLAMINE  | 8                 | 3                    | II             | -                  | 1 L                                      | E2                  | P001         | -            | IBC02         | -             |
| 2249   | DICHLORODIMETHYL ETHER, SYMMETRICAL  | 6.1               | 3                    | I              | 976                | 0  | E0                  | P099         | -            | -             | -             |
| 2250   | DICHLOROPHENYL ISOCYANATES   | 6.1               | -                    | II             | -                  | 500 g                                    | E4                  | P002         | -            | IBC08         | B4<br>B21     |
| 2251   | BICYCLO[2.2.1]-HEPTA-2,5-DIENE, STABILIZED (2,5-NORBORNADIENE, STABILIZED) | 3                 | -                    | II             | 386                | 1 L                                      | E2                  | P001         | -            | IBC02         | -             |
| 2252   | 1,2-DIMETHOXYETHANE  | 3                 | -                    | II             | -                  | 1 L                                      | E2                  | P001         | -            | IBC02         | -             |

| UN No. | Portable tanks and bulk containers |               | EmS                    | Stowage and handling     | Segregation   | Properties and observations   | UN No. |
|--------|------------------------------------|---------------|------------------------|--------------------------|---|---|--------|
|        | Tank instructions                  | Provisions    |                        |                          |   |   |        |
| (12)   | (13)<br>4.2.5<br>4.3               | (14)<br>4.2.5 | (15)<br>5.4.3.4<br>7.8 | (16a)<br>7.1<br>7.3-7.7  | (16b)<br>7.2-7.7                                    | (17)  | (18)   |
| -      | T4                                 | TP1           | F-A, S-A               | Category A               | -   | Colourless liquid. Immiscible with water. Toxic if swallowed, by skin contact or by inhalation.   | 2235   |
| -      | -                                  | -             | F-A, S-A               | Category B<br>SW2        | -   | Colourless liquid with a pungent odour. Immiscible with water. Reacts with water, evolving carbon dioxide. Toxic if swallowed, by skin contact or by inhalation. Irritating to skin, eyes and mucous membranes.   | 2236   |
| -      | T1                                 | TP33          | F-A, S-A               | Category A               | -   | Yellow or orange crystalline powders or needles. Insoluble in water. Toxic if swallowed, by skin contact or by dust inhalation.   | 2237   |
| -      | T2                                 | TP1           | F-E, S-D               | Category A               | SGG10   | Colourless to brown liquids. Flashpoint: 43°C to 47°C c.c. Immiscible with water. When involved in a fire, evolve toxic gases. Harmful by skin contact or by inhalation. Irritating to eyes and mucous membranes.   | 2238   |
| -      | T1                                 | TP33          | F-A, S-A               | Category A               | -   | Crystalline solids. Some isomers may melt at low temperature: melting range between 0°C and 24°C. Toxic if swallowed, by skin contact or by inhalation.   | 2239   |
| -      | T10                                | TP2<br>TP13   | F-A, S-B               | Category B<br>SW2        | SGG1<br>SG6<br>SG16<br>SG17<br>SG19<br>SG36<br>SG49 | A liquid mixture of sulphuric acid and a chromium compound (e.g. chromium trioxide or sodium dichromate) and sometimes also water. Highly corrosive to most metals. Causes severe burns to skin, eyes and mucous membranes.   | 2240   |
| -      | T4                                 | TP2           | F-E, S-D               | Category B<br>SW2        | -   | Oily liquid. Immiscible with water. Narcotic.   | 2241   |
| -      | T4                                 | TP1           | F-E, S-D               | Category B               | -   | Oily liquid. Immiscible with water.   | 2242   |
| -      | T2                                 | TP1           | F-E, S-D               | Category A               | -   | Colourless liquid. Flashpoint: 56°C c.c. Immiscible with water. Irritating to skin, eyes and mucous membranes.  | 2243   |
| -      | T2                                 | TP1           | F-E, S-D               | Category A               | -   | Colourless, oily liquid. Flashpoint: 51°C c.c. Immiscible with water.   | 2244   |
| -      | T2                                 | TP1           | F-E, S-D               | Category A               | -   | Colourless liquid. Flashpoint: 31°C c.c. Immiscible with water.   | 2245   |
| -      | T7                                 | TP2           | F-E, S-D               | Category E               | -   | Colourless liquid. Flashpoint: -30°C c.c. Boiling point: 44°C. Immiscible with water. Irritating to skin, eyes and mucous membranes. Narcotic.  | 2246   |
| -      | T2                                 | TP1           | F-E, S-E               | Category A               | -   | Colourless liquid. Flashpoint: 47°C c.c. Explosive limits: 0.6% to 5.5%. Immiscible with water.   | 2247   |
| -      | T7                                 | TP2           | F-E, S-C               | Category A               | SG35  | Colourless, flammable liquid with an amine odour. Flashpoint: 39°C c.c. Partially miscible with water. Decomposes when heated, evolving flammable and toxic gases. Liquid is corrosive to skin, eyes and mucous membranes. Vapour irritates mucous membranes.   | 2248   |
| -      | -                                  | -             | F-E, S-D               | Category D<br>SW2        | -   | Colourless, volatile, flammable liquid. Flashpoint: 42°C c.c. Immiscible with water. Decomposed by heat and water. Highly toxic if swallowed, by skin contact or by inhalation. The transport of this substance is prohibited except with special authorization granted by the competent authorities. | 2249   |
| -      | T3                                 | TP33          | F-A, S-A               | Category B<br>SW1<br>SW2 | -   | Colourless to yellowish crystalline solid with an irritating odour. Insoluble in water. Reacts with water, evolving carbon dioxide. Toxic if swallowed, by skin contact or by inhalation. May be carried in the molten state. Irritating to skin, eyes and mucous membranes.                          | 2250   |
| -      | T7                                 | TP2           | F-E, S-D               | Category D<br>SW1        | -   | Colourless, volatile liquid. Flashpoint: below -18°C c.c. Explosive limits: 1.7% to 6.3%. Immiscible with water.  | 2251   |
| -      | T4                                 | TP1           | F-E, S-D               | Category B               | -   | Colourless liquid with an ethereal odour. Flashpoint: 1°C c.c. Miscible with water.   | 2252   |

Part 3 – Dangerous Goods List, special provisions and exceptions

Chapter 3.2 – Dangerous Goods List

| UN No. | Proper shipping name (PSN)   | Class or division | Subsidiary hazard(s) | Packing group  | Special provisions | Limited and excepted quantity provisions |                     | Packing      |              | IBC           |               |
|--------|--|-------------------|----------------------|----------------|--------------------|--|---------------------|--------------|--------------|---------------|---------------|
|        |  |                   |                      |                |                    | Limited quantities                       | Excepted quantities | Instructions | Provisions   | Instructions  | Provisions    |
| (1)    | (2)<br>3.1.2   | (3)<br>2.0        | (4)<br>2.0           | (5)<br>2.0.1.3 | (6)<br>3.3         | (7a)<br>3.4                              | (7b)<br>3.5         | (8)<br>4.1.4 | (9)<br>4.1.4 | (10)<br>4.1.4 | (11)<br>4.1.4 |
| 2253   | N,N-DIMETHYLANILINE  | 6.1               | –                    | II             | –                  | 100 mL                                   | E4                  | P001         | –            | IBC02         | –             |
| 2254   | MATCHES, FUSEE   | 4.1               | –                    | III            | 293                | 5 kg                                     | E0                  | P407         | –            | –             | –             |
| 2256   | CYCLOHEXENE  | 3                 | –                    | II             | –                  | 1 L                                      | E2                  | P001         | –            | IBC02         | –             |
| 2257   | POTASSIUM  | 4.3               | –                    | I              | –                  | 0  | E0                  | P403         | PP31         | IBC04         | B1            |
| 2258   | 1,2-PROPYLENEDIAMINE   | 8                 | 3                    | II             | –                  | 1 L                                      | E2                  | P001         | –            | IBC02         | –             |
| 2259   | TRIETHYLENETETRAMINE   | 8                 | –                    | II             | –                  | 1 L                                      | E2                  | P001         | –            | IBC02         | –             |
| 2260   | TRIPROPYLAMINE   | 3                 | 8                    | III            | –                  | 5 L                                      | E1                  | P001         | –            | IBC03         | –             |
| 2261   | XYLENOLS, SOLID  | 6.1               | –                    | II             | –                  | 500 g                                    | E4                  | P002         | –            | IBC08         | B4<br>B21     |
| 2262   | DIMETHYLCARBAMOYL CHLORIDE   | 8                 | –                    | II             | –                  | 1 L                                      | E2                  | P001         | –            | IBC02         | –             |
| 2263   | DIMETHYLCYCLOHEXANES   | 3                 | –                    | II             | –                  | 1 L                                      | E2                  | P001         | –            | IBC02         | –             |
| 2264   | N,N-DIMETHYL-CYCLOHEXYLAMINE   | 8                 | 3                    | II             | –                  | 1 L                                      | E2                  | P001         | –            | IBC02         | –             |
| 2265   | N,N-DIMETHYLFORMAMIDE  | 3                 | –                    | III            | –                  | 5 L                                      | E1                  | P001<br>LP01 | –            | IBC03         | –             |
| 2266   | DIMETHYL-N-PROPYLAMINE   | 3                 | 8                    | II             | –                  | 1 L                                      | E2                  | P001         | –            | IBC02         | –             |
| 2267   | DIMETHYL THIOPHOSPHORYL CHLORIDE   | 6.1               | 8                    | II             | –                  | 100 mL                                   | E4                  | P001         | –            | IBC02         | –             |
| 2269   | 3,3'-IMINODIPROPYLAMINE  | 8                 | –                    | III            | –                  | 5 L                                      | E1                  | P001<br>LP01 | –            | IBC03         | –             |
| 2270   | ETHYLAMINE, AQUEOUS SOLUTION with not less than 50% but not more than 70% ethylamine | 3                 | 8                    | II             | –                  | 1 L                                      | E2                  | P001         | –            | IBC02         | –             |

| UN No. | Portable tanks and bulk containers |               | EmS                    | Stowage and handling    | Segregation          | Properties and observations   | UN No. |
|--------|------------------------------------|---------------|------------------------|-------------------------|----------------------|---|--------|
|        | Tank instructions                  | Provisions    |                        |                         |                      |   |        |
| (12)   | (13)<br>4.2.5<br>4.3               | (14)<br>4.2.5 | (15)<br>5.4.3.4<br>7.8 | (16a)<br>7.1<br>7.3–7.7 | (16b)<br>7.2–7.7     | (17)  | (18)   |
| –      | T7                                 | TP2           | F-A, S-A               | Category A              | –                    | Yellowish to brownish oily liquid. Combustible. Toxic if swallowed, by skin contact or by inhalation.   | 2253   |
| –      | –                                  | –             | F-A, S-I               | Category A              | –                    | Matches, the heads of which are prepared with a friction-sensitive igniter composition and a pyrotechnic composition which burns with little or no flame, but with intense heat, regardless of wind or other weather conditions.  | 2254   |
| –      | T4                                 | TP1           | F-E, S-D               | Category E              | –                    | Colourless liquid with an aromatic odour. Immiscible with water. Slightly irritating to skin, eyes and mucous membranes.  | 2256   |
| –      | T9                                 | TP7<br>TP33   | F-G, S-N               | Category D<br>H1        | SG26<br>SG35         | Soft, silvery metal, solid or liquid. Floats on water. Reacts violently with moisture, water or acids, evolving hydrogen, which may be ignited by the heat of the reaction. Highly reactive, sometimes with explosive effect.   | 2257   |
| –      | T7                                 | TP2           | F-E, S-C               | Category A<br>SW2       | SG35                 | Colourless, flammable liquid with an ammoniacal odour. Flashpoint range: 33°C to 48°C c.c. Miscible with water. When involved in a fire, evolves toxic gases. Harmful by inhalation. Causes burns to skin and eyes. Irritating to mucous membranes.   | 2258   |
| –      | T7                                 | TP2           | F-A, S-B               | Category B<br>SW2       | SGG18<br>SG35        | Moderately viscous, yellow combustible liquid with an ammoniacal odour. Miscible with water. Strongly alkaline. Can form explosive mixtures with nitric acid. When involved in a fire, evolves toxic gases. Corrosive to copper and copper alloys. Reacts violently with acids. Liquid and vapours cause burns to skin, eyes and mucous membranes. Causes skin allergy. | 2259   |
| –      | T4                                 | TP1           | F-E, S-C               | Category A<br>SW2       | SG35                 | Colourless liquid. Flashpoint: 35°C c.c. Partially miscible with water. When involved in a fire, evolves toxic gases. Harmful by inhalation. Causes burns to skin and eyes. Irritating to mucous membranes.   | 2260   |
| –      | T3                                 | TP33          | F-A, S-A               | Category A              | –                    | Crystals or needles. Toxic if swallowed, by skin contact or by inhalation.  | 2261   |
| –      | T7                                 | TP2           | F-A, S-B               | Category A<br>SW2       | SGG1<br>SG36<br>SG49 | Colourless to yellow liquid with a pungent odour. Immiscible with water. Reacts with water, evolving toxic and corrosive fumes. Causes tears. Causes burns to skin, eyes and mucous membranes.  | 2262   |
| –      | T4                                 | TP1           | F-E, S-D               | Category B              | –                    | Colourless liquids. Flashpoint: 5°C to 16°C c.c. Immiscible with water.   | 2263   |
| –      | T7                                 | TP2           | F-E, S-C               | Category A<br>SW2       | SG35                 | Colourless, flammable liquid. Flashpoint: 43°C c.c. Partially miscible with water. Causes burns to skin, eyes and mucous membranes.   | 2264   |
| –      | T2                                 | TP2           | F-E, S-D               | Category A              | –                    | Colourless liquid. Flashpoint: 58°C c.c. Explosive limits: 2.2% to 16%. Miscible with water. May react violently with oxidizing materials.  | 2265   |
| –      | T7                                 | TP2<br>TP13   | F-E, S-C               | Category B<br>SW2       | SG35                 | Colourless liquid with a fishy odour. Flashpoint: –11°C c.c. Miscible with water. Harmful by inhalation. Causes burns to skin, eyes and mucous membranes.   | 2266   |
| –      | T7                                 | TP2           | F-A, S-B               | Category B<br>SW1       | SGG1<br>SG36<br>SG49 | Colourless, combustible liquid with a pungent odour. Reacts slowly with water, evolving hydrogen chloride, a corrosive gas apparent as white fumes. May decompose above 60°C, evolving flammable gases. Toxic if swallowed, by skin contact or by inhalation. Causes burns to skin, eyes and mucous membranes.  | 2267   |
| –      | T4                                 | TP2           | F-A, S-B               | Category A              | SG35                 | Colourless combustible liquid. Miscible with water. Harmful if swallowed or by inhalation. Corrosive to skin, eyes and mucous membranes.  | 2269   |
| –      | T7                                 | TP1           | F-E, S-C               | Category B<br>SW2       | SGG18<br>SG35        | Aqueous solution of a flammable gas with an ammonia-like odour. Explosive limits: 3.5% to 14%. ETHYLAMINE SOLUTION, concentration 50%: flashpoint –11°C c.c.; boiling point 56°C. Pure ETHYLAMINE: boiling point 17°C. Miscible with water. Harmful by inhalation. Causes burns to skin, eyes and mucous membranes. Reacts violently with acids.                        | 2270   |



Part 3 – Dangerous Goods List, special provisions and exceptions

Chapter 3.2 – Dangerous Goods List

| UN No. | Proper shipping name (PSN)        | Class or division | Subsidiary hazard(s) | Packing group  | Special provisions | Limited and excepted quantity provisions |                     | Packing      |              | IBC           |               |
|--------|-----------------------------------|-------------------|----------------------|----------------|--------------------|--|---------------------|--------------|--------------|---------------|---------------|
|        |                                   |                   |                      |                |                    | Limited quantities                       | Excepted quantities | Instructions | Provisions   | Instructions  | Provisions    |
| (1)    | (2)<br>3.1.2                      | (3)<br>2.0        | (4)<br>2.0           | (5)<br>2.0.1.3 | (6)<br>3.3         | (7a)<br>3.4                              | (7b)<br>3.5         | (8)<br>4.1.4 | (9)<br>4.1.4 | (10)<br>4.1.4 | (11)<br>4.1.4 |
| 2271   | ETHYL AMYL KETONES                | 3                 | –                    | III            | –                  | 5 L                                      | E1                  | P001<br>LP01 | –            | IBC03         | –             |
| 2272   | N-ETHYLANILINE                    | 6.1               | –                    | III            | –                  | 5 L                                      | E1                  | P001<br>LP01 | –            | IBC03         | –             |
| 2273   | 2-ETHYLANILINE                    | 6.1               | –                    | III            | –                  | 5 L                                      | E1                  | P001<br>LP01 | –            | IBC03         | –             |
| 2274   | N-ETHYL-N-BENZYLANILINE           | 6.1               | –                    | III            | –                  | 5 L                                      | E1                  | P001<br>LP01 | –            | IBC03         | –             |
| 2275   | 2-ETHYLBUTANOL                    | 3                 | –                    | III            | –                  | 5 L                                      | E1                  | P001<br>LP01 | –            | IBC03         | –             |
| 2276   | 2-ETHYLHEXYLAMINE                 | 3                 | 8                    | III            | –                  | 5 L                                      | E1                  | P001         | –            | IBC03         | –             |
| 2277   | ETHYL METHACRYLATE, STABILIZED    | 3                 | –                    | II             | 386                | 1 L                                      | E2                  | P001         | –            | IBC02         | –             |
| 2278   | n-HEPTENE                         | 3                 | –                    | II             | –                  | 1 L                                      | E2                  | P001         | –            | IBC02         | –             |
| 2279   | HEXACHLOROBUTADIENE               | 6.1               | –<br>P               | III            | –                  | 5 L                                      | E1                  | P001<br>LP01 | –            | IBC03         | –             |
| 2280   | HEXAMETHYLENEDIAMINE, MOLTEN      | 8                 | –                    | III            | –                  | 0  | E0                  | –            | –            | –             | –             |
| 2280   | HEXAMETHYLENEDIAMINE, SOLID       | 8                 | –                    | III            | –                  | 5 kg                                     | E1                  | P002<br>LP02 | –            | IBC08         | B3            |
| 2281   | HEXAMETHYLENE DIISOCYANATE        | 6.1               | –                    | II             | –                  | 100 mL                                   | E4                  | P001         | –            | IBC02         | –             |
| 2282   | HEXANOLS                          | 3                 | –                    | III            | –                  | 5 L                                      | E1                  | P001<br>LP01 | –            | IBC03         | –             |
| 2283   | ISOBUTYL METHACRYLATE, STABILIZED | 3                 | –                    | III            | 386                | 5 L                                      | E1                  | P001<br>LP01 | –            | IBC03         | –             |
| 2284   | ISOBUTYRONITRILE                  | 3                 | 6.1                  | II             | –                  | 1 L                                      | E2                  | P001         | –            | IBC02         | –             |
| 2285   | ISOCYANATOBENZO-TRIFLUORIDES      | 6.1               | 3                    | II             | –                  | 100 mL                                   | E4                  | P001         | –            | IBC02         | –             |
| 2286   | PENTAMETHYLHEPTANE                | 3                 | –                    | III            | –                  | 5 L                                      | E1                  | P001<br>LP01 | –            | IBC03         | –             |
| 2287   | ISOHEPTENES                       | 3                 | –                    | II             | –                  | 1 L                                      | E2                  | P001         | –            | IBC02         | –             |
| 2288   | ISOHEXENES                        | 3                 | –                    | II             | –                  | 1 L                                      | E2                  | P001         | –            | IBC02         | B8            |

| UN No. | Portable tanks and bulk containers |               | EmS                    | Stowage and handling     | Segregation      | Properties and observations   | UN No. |
|--------|------------------------------------|---------------|------------------------|--------------------------|------------------|---|--------|
|        | Tank instructions                  | Provisions    |                        |                          |                  |   |        |
| (12)   | (13)<br>4.2.5<br>4.3               | (14)<br>4.2.5 | (15)<br>5.4.3.4<br>7.8 | (16a)<br>7.1<br>7.3–7.7  | (16b)<br>7.2–7.7 | (17)  | (18)   |
| –      | T2                                 | TP1           | F-E, S-D               | Category A               | –                | Colourless liquids. Vapour is much heavier than air (4.4). ETHYL <i>normal</i> -AMYL KETONE: flashpoint 43°C c.c. ETHYL <i>secondary</i> -AMYL KETONE: flashpoint 57°C c.c. Immiscible with water. Dissolves some types of plastics. Irritating to skin, eyes and mucous membranes.           | 2271   |
| –      | T4                                 | TP1           | F-A, S-A               | Category A               | SG17<br>SG35     | Colourless to yellowish oily liquid. Reacts with acids, evolving highly toxic fumes of aniline and oxides of nitrogen. Reacts violently with oxidizing substances. Toxic if swallowed, by skin contact or by inhalation.  | 2272   |
| –      | T4                                 | TP1           | F-A, S-A               | Category A               | SG17<br>SG35     | Brown liquid. Immiscible with water. Reacts with acids, evolving highly toxic fumes of aniline and oxides of nitrogen. Reacts violently with oxidizing substances. Toxic if swallowed, by skin contact or by inhalation.  | 2273   |
| –      | T4                                 | TP1           | F-A, S-A               | Category A               | –                | Light yellow, oily liquid. Immiscible with water. Toxic if swallowed, by skin contact or by inhalation.   | 2274   |
| –      | T2                                 | TP1           | F-E, S-D               | Category A               | –                | Colourless liquid. Flashpoint: 57°C o.c. Immiscible with water.   | 2275   |
| –      | T4                                 | TP1           | F-E, S-C               | Category A<br>SW2        | SG35             | Colourless liquid. Flashpoint: 50°C c.c. Miscible with water. Irritating to skin, eyes and mucous membranes.  | 2276   |
| –      | T4                                 | TP1           | F-E, S-D               | Category C<br>SW1        | –                | Colourless liquid with a pungent odour. Flashpoint: 20°C o.c. Lower explosive limit: 1.8%. Immiscible with water. Irritating to skin, eyes and mucous membranes.  | 2277   |
| –      | T4                                 | TP1           | F-E, S-D               | Category B               | –                | Colourless liquid. Flashpoint: –3°C c.c. Immiscible with water.   | 2278   |
| –      | T4                                 | TP1           | F-A, S-A               | Category A               | SGG10            | Colourless liquid. Immiscible with water. Toxic if swallowed, by skin contact or by inhalation.   | 2279   |
| –      | T4                                 | TP1           | F-A, S-B               | Category A<br>SW1<br>H2  | SG35             | White crystals or shiny flakes with a specific odour. Melting point: 29°C. Soluble in water; solution in water is a strong alkali. Decomposes when heated, evolving flammable and toxic gases. Causes burns to skin, eyes and mucous membranes.   | 2280   |
| –      | T1                                 | TP33          | F-A, S-B               | Category A<br>SW1<br>H2  | SG35             | See entry above.  | 2280   |
| –      | T7                                 | TP2<br>TP13   | F-A, S-A               | Category C<br>SW2<br>H1  | –                | Colourless to light yellow liquid with a pungent odour. Immiscible with water but reacts with it, evolving heat and carbon dioxide gas. When heated, evolves toxic nitrous fumes. Toxic if swallowed, by skin contact or by inhalation. Irritating to skin, eyes and mucous membranes.        | 2281   |
| –      | T2                                 | TP1           | F-E, S-D               | Category A               | –                | Colourless liquids. <i>normal</i> -HEXANOL: flashpoint 57°C c.c. Miscible with water.   | 2282   |
| –      | T2                                 | TP1           | F-E, S-D               | Category C<br>SW1        | –                | Colourless liquid. Flashpoint: 49°C c.c. Immiscible with water. Irritating to skin, eyes and mucous membranes.  | 2283   |
| –      | T7                                 | TP2<br>TP13   | F-E, S-D               | Category E<br>SW2        | –                | Colourless liquid. Flashpoint: 8°C c.c. Immiscible with water. Toxic by skin contact or by inhalation.  | 2284   |
| –      | T7                                 | TP2           | F-E, S-D               | Category D<br>SW1<br>SW2 | –                | Colourless or yellowish liquids with a pungent odour. Flashpoint of <i>ortho</i> - and <i>meta</i> -isomers: 56°C. Immiscible with water, but reacts with it to form carbon dioxide gas. Toxic if swallowed, by skin contact or by inhalation. Irritating to skin, eyes and mucous membranes. | 2285   |
| –      | T2                                 | TP1           | F-E, S-D               | Category A               | –                | Colourless liquid. Flashpoint: 43°C c.c. Immiscible with water.   | 2286   |
| –      | T4                                 | TP1           | F-E, S-D               | Category B               | –                | Colourless liquids. Immiscible with water.  | 2287   |
| –      | T11                                | TP1           | F-E, S-D               | Category E               | –                | Colourless liquids. Boiling range: 54°C to 69°C. Immiscible with water.   | 2288   |

Part 3 – Dangerous Goods List, special provisions and exceptions

Chapter 3.2 – Dangerous Goods List

| UN No. | Proper shipping name (PSN)        | Class or division | Subsidiary hazard(s) | Packing group  | Special provisions | Limited and excepted quantity provisions |                     | Packing      |              | IBC           |               |
|--------|-----------------------------------|-------------------|----------------------|----------------|--------------------|--|---------------------|--------------|--------------|---------------|---------------|
|        |                                   |                   |                      |                |                    | Limited quantities                       | Excepted quantities | Instructions | Provisions   | Instructions  | Provisions    |
| (1)    | (2)<br>3.1.2                      | (3)<br>2.0        | (4)<br>2.0           | (5)<br>2.0.1.3 | (6)<br>3.3         | (7a)<br>3.4                              | (7b)<br>3.5         | (8)<br>4.1.4 | (9)<br>4.1.4 | (10)<br>4.1.4 | (11)<br>4.1.4 |
| 2289   | ISOPHORONEDIAMINE                 | 8                 | –                    | III            | –                  | 5 L                                      | E1                  | P001<br>LP01 | –            | IBC03         | –             |
| 2290   | ISOPHORONE DIISOCYANATE           | 6.1               | –                    | III            | –                  | 5 L                                      | E1                  | P001<br>LP01 | –            | IBC03         | –             |
| 2291   | LEAD COMPOUND, SOLUBLE, N.O.S.    | 6.1               | –<br>P               | III            | 199<br>274         | 5 kg                                     | E1                  | P002<br>LP02 | –            | IBC08         | B3            |
| 2293   | 4-METHOXY-4-METHYL-PENTAN-2-ONE   | 3                 | –                    | III            | –                  | 5 L                                      | E1                  | P001<br>LP01 | –            | IBC03         | –             |
| 2294   | N-METHYLANILINE                   | 6.1               | –<br>P               | III            | –                  | 5 L                                      | E1                  | P001<br>LP01 | –            | IBC03         | –             |
| 2295   | METHYL CHLOROACETATE              | 6.1               | 3                    | I              | –                  | 0  | E0                  | P001         | –            | –             | –             |
| 2296   | METHYLCYCLOHEXANE                 | 3                 | –<br>P               | II             | –                  | 1 L                                      | E2                  | P001         | –            | IBC02         | –             |
| 2297   | METHYLCYCLOHEXANONE               | 3                 | –                    | III            | –                  | 5 L                                      | E1                  | P001<br>LP01 | –            | IBC03         | –             |
| 2298   | METHYLCYCLOPENTANE                | 3                 | –                    | II             | –                  | 1 L                                      | E2                  | P001         | –            | IBC02         | –             |
| 2299   | METHYL DICHLOROACETATE            | 6.1               | –                    | III            | –                  | 5 L                                      | E1                  | P001<br>LP01 | –            | IBC03         | –             |
| 2300   | 2-METHYL-5-ETHYLPYRIDINE          | 6.1               | –                    | III            | –                  | 5 L                                      | E1                  | P001<br>LP01 | –            | IBC03         | –             |
| 2301   | 2-METHYLFURAN                     | 3                 | –                    | II             | –                  | 1 L                                      | E2                  | P001         | –            | IBC02         | –             |
| 2302   | 5-METHYLHEXAN-2-ONE               | 3                 | –                    | III            | –                  | 5 L                                      | E1                  | P001<br>LP01 | –            | IBC03         | –             |
| △ 2303 | ISOPROPENYLBENZENE                | 3                 | –<br>P               | III            | –                  | 5 L                                      | E1                  | P001<br>LP01 | –            | IBC03         | –             |
| 2304   | NAPHTHALENE, MOLTEN               | 4.1               | –<br>P               | III            | –                  | 0  | E0                  | –            | –            | –             | –             |
| 2305   | NITROBENZENESULPHONIC ACID        | 8                 | –                    | II             | –                  | 1 kg                                     | E2                  | P002         | –            | IBC08         | B4<br>B21     |
| 2306   | NITROBENZOTRIFLUORIDES, LIQUID    | 6.1               | –<br>P               | II             | –                  | 100 mL                                   | E4                  | P001         | –            | IBC02         | –             |
| 2307   | 3-NITRO-4-CHLORO-BENZOTRIFLUORIDE | 6.1               | –<br>P               | II             | –                  | 100 mL                                   | E4                  | P001         | –            | IBC02         | –             |

| UN No. | Portable tanks and bulk containers |               | EmS                    | Stowage and handling    | Segregation          | Properties and observations   | UN No. |
|--------|------------------------------------|---------------|------------------------|-------------------------|----------------------|---|--------|
|        | Tank instructions                  | Provisions    |                        |                         |                      |   |        |
| (12)   | (13)<br>4.2.5<br>4.3               | (14)<br>4.2.5 | (15)<br>5.4.3.4<br>7.8 | (16a)<br>7.1<br>7.3–7.7 | (16b)<br>7.2–7.7     | (17)  | (18)   |
| –      | T4                                 | TP1           | F-A, S-B               | Category A              | SG35                 | Colourless, slightly hygroscopic liquid with a slight amine odour. Combustible. Miscible with water. Harmful if swallowed. Irritating to skin, eyes and mucous membranes.   | 2289   |
| –      | T4                                 | TP2           | F-A, S-A               | Category B<br>SW2       | –                    | Colourless or yellowish liquid. Immiscible with water. When involved in a fire, evolves nitrous fumes. Toxic if swallowed, by skin contact or by inhalation. Irritating to skin, eyes and mucous membranes.   | 2290   |
| –      | T1                                 | TP33          | F-A, S-A               | Category A              | SGG7<br>SGG9         | Colourless crystals or powder. Soluble in water. Toxic if swallowed, by skin contact or by dust inhalation.   | 2291   |
| –      | T2                                 | TP1           | F-E, S-D               | Category A              | –                    | Colourless liquid. Flashpoint: 49°C c.c. Immiscible with water.   | 2293   |
| –      | T4                                 | TP2           | F-A, S-A               | Category A              | –                    | Colourless to brown combustible liquid. Toxic if swallowed, by skin contact or by inhalation.   | 2294   |
| –      | T14                                | TP2<br>TP13   | F-E, S-D               | Category D              | –                    | Colourless, flammable liquid with a pungent odour. Flashpoint: 47°C c.c. Vapour much heavier than air (vapour density relative to air: 3.8). Immiscible with water. Highly toxic if swallowed, by skin contact or by inhalation.  | 2295   |
| –      | T4                                 | TP2           | F-E, S-D               | Category B              | –                    | Colourless liquid. Flashpoint: –4°C c.c. Explosive limits: 1.2% to 6.7%. Immiscible with water. Irritating to skin, eyes and mucous membranes.  | 2296   |
| –      | T2                                 | TP1           | F-E, S-D               | Category A              | –                    | Colourless to pale yellow liquids with a sweet odour. 2-METHYLCYCLOHEXANONE: flashpoint 46°C c.c. 3-METHYLCYCLOHEXANONE: flashpoint 51°C c.c. 4-METHYLCYCLOHEXANONE: flashpoint 40°C c.c. Immiscible with water.  | 2297   |
| –      | T4                                 | TP1           | F-E, S-D               | Category B              | –                    | Colourless liquid. Flashpoint: below –10°C c.c. Explosive limits: 1% to 8.4%. Immiscible with water. Irritating to skin, eyes and mucous membranes.   | 2298   |
| –      | T4                                 | TP1           | F-A, S-A               | Category A              | –                    | Liquid. Toxic if swallowed, by skin contact or by inhalation.   | 2299   |
| –      | T4                                 | TP1           | F-A, S-A               | Category A              | –                    | Colourless liquid with a pungent odour. Toxic if swallowed, by skin contact or by inhalation.   | 2300   |
| –      | T4                                 | TP1           | F-E, S-D               | Category E              | –                    | Colourless liquid with a sweetish odour. Flashpoint: –30°C c.c. Immiscible with water. When involved in a fire, evolves toxic gases. Harmful if swallowed or by inhalation. Irritating to skin, eyes and mucous membranes.  | 2301   |
| –      | T2                                 | TP1           | F-E, S-D               | Category A              | –                    | Colourless liquid. Flashpoint: 43°C c.c. Immiscible with water.   | 2302   |
| –      | T2                                 | TP1           | F-E, S-D               | Category A<br>SW1       | –                    | Colourless liquid. Flashpoint: 38°C to 54°C c.c. Explosive limits: 0.7% to 6.6%. Immiscible with water. Irritating to skin, eyes and mucous membranes.  | 2303 △ |
| –      | T1                                 | TP3           | F-A, S-H               | Category C              | –                    | Molten liquid with a persistent odour. Melting point: 80°C. Evolves flammable vapours. As the melting point of naphthalene approximates very closely its flashpoint, care should be taken to avoid all possible causes of ignition. Contact between water and molten naphthalene above 110°C must be avoided, as the addition of water will cause violent foaming or even an explosion. | 2304   |
| –      | T3                                 | TP33          | F-A, S-B               | Category A              | SGG1<br>SG36<br>SG49 | Crystals. Soluble in water. Causes burns to skin, eyes and mucous membranes.  | 2305   |
| –      | T7                                 | TP2           | F-A, S-A               | Category A<br>SW2       | –                    | Pale straw-coloured, oily liquids with an aromatic odour. Immiscible with water. Toxic if swallowed, by skin contact or by inhalation.  | 2306   |
| –      | T7                                 | TP2           | F-A, S-A               | Category A<br>SW2       | –                    | Yellowish, oily liquid. Immiscible with water. Toxic if swallowed, by skin contact or by inhalation.  | 2307   |

Part 3 – Dangerous Goods List, special provisions and exceptions

Chapter 3.2 – Dangerous Goods List

| UN No. | Proper shipping name (PSN)                                       | Class or division | Subsidiary hazard(s) | Packing group  | Special provisions | Limited and excepted quantity provisions |                     | Packing      |              | IBC           |               |
|--------|--|-------------------|----------------------|----------------|--------------------|--|---------------------|--------------|--------------|---------------|---------------|
|        |  |                   |                      |                |                    | Limited quantities                       | Excepted quantities | Instructions | Provisions   | Instructions  | Provisions    |
| (1)    | (2)<br>3.1.2   | (3)<br>2.0        | (4)<br>2.0           | (5)<br>2.0.1.3 | (6)<br>3.3         | (7a)<br>3.4                              | (7b)<br>3.5         | (8)<br>4.1.4 | (9)<br>4.1.4 | (10)<br>4.1.4 | (11)<br>4.1.4 |
| 2308   | NITROSYLSULPHURIC ACID, LIQUID                                   | 8                 | –                    | II             | –                  | 1 L                                      | E2                  | P001         | –            | IBC02         | B20           |
| 2309   | OCTADIENE  | 3                 | –                    | II             | –                  | 1 L                                      | E2                  | P001         | –            | IBC02         | –             |
| 2310   | PENTANE-2,4-DIONE  | 3                 | 6.1                  | III            | –                  | 5 L                                      | E1                  | P001         | –            | IBC03         | –             |
| 2311   | PHENETIDINES   | 6.1               | –                    | III            | 279                | 5 L                                      | E1                  | P001<br>LP01 | –            | IBC03         | –             |
| 2312   | PHENOL, MOLTEN   | 6.1               | –                    | II             | –                  | 0  | E0                  | –            | –            | –             | –             |
| 2313   | PICOLINES  | 3                 | –                    | III            | –                  | 5 L                                      | E1                  | P001<br>LP01 | –            | IBC03         | –             |
| 2315   | POLYCHLORINATED BIPHENYLS, LIQUID                                | 9                 | –<br>P               | II             | 305                | 1 L                                      | E2                  | P906         | –            | IBC02         | –             |
| 2316   | SODIUM CUPROCYANIDE, SOLID                                       | 6.1               | –<br>P               | I              | –                  | 0  | E5                  | P002         | –            | IBC07         | B1            |
| 2317   | SODIUM CUPROCYANIDE SOLUTION                                     | 6.1               | –<br>P               | I              | –                  | 0  | E5                  | P001         | –            | –             | –             |
| 2318   | SODIUM HYDROSULPHIDE with less than 25% water of crystallization | 4.2               | –                    | II             | –                  | 0  | E2                  | P410         | PP31         | IBC06         | B21           |
| 2319   | TERPENE HYDROCARBONS, N.O.S.                                     | 3                 | –                    | III            | –                  | 5 L                                      | E1                  | P001<br>LP01 | –            | IBC03         | –             |
| 2320   | TETRAETHYLENEPENTAMINE   | 8                 | –                    | III            | –                  | 5 L                                      | E1                  | P001<br>LP01 | –            | IBC03         | –             |
| 2321   | TRICHLOROBENZENES, LIQUID  | 6.1               | –<br>P               | III            | –                  | 5 L                                      | E1                  | P001<br>LP01 | –            | IBC03         | –             |
| 2322   | TRICHLOROBUTENE  | 6.1               | –<br>P               | II             | –                  | 100 mL                                   | E4                  | P001         | –            | IBC02         | –             |
| 2323   | TRIETHYL PHOSPHITE   | 3                 | –                    | III            | –                  | 5 L                                      | E1                  | P001<br>LP01 | –            | IBC03         | –             |
| 2324   | TRIIISOBUTYLENE  | 3                 | –                    | III            | –                  | 5 L                                      | E1                  | P001<br>LP01 | –            | IBC03         | –             |
| 2325   | 1,3,5-TRIMETHYLBENZENE   | 3                 | –<br>P               | III            | –                  | 5 L                                      | E1                  | P001<br>LP01 | –            | IBC03         | –             |
| 2326   | TRIMETHYLCYCLOHEXYLAMINE   | 8                 | –                    | III            | –                  | 5 L                                      | E1                  | P001<br>LP01 | –            | IBC03         | –             |

| UN No. | Portable tanks and bulk containers |               | EmS                    | Stowage and handling     | Segregation   | Properties and observations   | UN No. |
|--------|------------------------------------|---------------|------------------------|--------------------------|---|---|--------|
|        | Tank instructions                  | Provisions    |                        |                          |   |   |        |
| (12)   | (13)<br>4.2.5<br>4.3               | (14)<br>4.2.5 | (15)<br>5.4.3.4<br>7.8 | (16a)<br>7.1<br>7.3–7.7  | (16b)<br>7.2–7.7                                    | (17)  | (18)   |
| –      | T8                                 | TP2           | F-A, S-B               | Category D<br>SW2        | SGG1<br>SG6<br>SG16<br>SG17<br>SG19<br>SG36<br>SG49 | Clear, straw-coloured, oily liquid. Oxidant which may cause fire with organic materials (such as wood, straw, etc.). When involved in a fire, evolves toxic gases. In the presence of moisture, highly corrosive to most metals. Causes burns to skin, eyes and mucous membranes.   | 2308   |
| –      | T4                                 | TP1           | F-E, S-D               | Category B               | –   | Colourless liquid. Flashpoint: 9°C to 15°C c.c. Immiscible with water.  | 2309   |
| –      | T4                                 | TP1           | F-E, S-D               | Category A               | –   | Colourless liquid. Flashpoint: 34°C c.c. Lower explosive limit: 1.7%. Miscible with water. Toxic if swallowed, by skin contact or by inhalation.  | 2310   |
| –      | T4                                 | TP1           | F-A, S-A               | Category A               | –   | Colourless to yellowish liquids. Immiscible with water. Toxic if swallowed, by skin contact or by inhalation.   | 2311   |
| –      | T7                                 | TP3           | F-A, S-A               | Category B<br>SW2        | –   | Molten liquid with a distinctive strong odour. Melting point: 10°C to 43°C (pure product). Toxic if swallowed, by skin contact or by inhalation. Rapidly absorbed through the skin.   | 2312   |
| –      | T4                                 | TP1           | F-E, S-D               | Category A<br>SW2        | –   | Colourless to yellow liquids with a pungent or sweet odour. Explosive limits: 1.3% to 8.7%. Miscible with water. Harmful by inhalation.<br><i>alpha</i> -Picoline flashpoint: 28°C c.c.<br><i>beta</i> -Picoline flashpoint: 40°C c.c.<br><i>gamma</i> -Picoline flashpoint 40°C c.c.<br>Irritating to skin, eyes and mucous membranes. | 2313   |
| –      | T4                                 | TP1           | F-A, S-A               | Category A               | SG50  | Colourless liquid (pure product) with perceptible odours. Immiscible with water. Harmful by ingestion or by skin contact. If spilled, can be a persistent hazard to the environment. This entry also covers articles, such as transformers and condensers, containing free liquid polychlorinated biphenyls.                            | 2315   |
| –      | T6                                 | TP33          | F-A, S-A               | Category A               | SGG6<br>SG35  | White powder. Soluble in water. Reacts with acids or acid fumes, evolving hydrogen cyanide, a highly toxic and flammable gas. Highly toxic if swallowed, by skin contact or by dust inhalation.   | 2316   |
| –      | T14                                | TP2<br>TP13   | F-A, S-A               | Category B<br>SW2        | SGG6<br>SG35  | Colourless liquid. Miscible with water. Decomposed by acids, evolving hydrogen cyanide, a highly toxic and flammable gas. Highly toxic if swallowed, by skin contact or by inhalation.  | 2317   |
| –      | T3                                 | TP33          | F-A, S-J               | Category A               | SGG18<br>SG35                                       | Colourless needles to lemon-coloured flakes. Soluble in water. Reacts violently with acids.   | 2318   |
| –      | T4                                 | TP1<br>TP29   | F-E, S-D               | Category A               | –   | Colourless or yellowish liquids. Flashpoint: 32°C to 49°C c.c. Immiscible with water.   | 2319   |
| –      | T4                                 | TP1           | F-A, S-B               | Category A               | SGG18<br>SG35                                       | Viscous liquid. Miscible with water. When involved in a fire, evolves toxic gases. Causes burns to skin, eyes and mucous membranes. Reacts violently with acids.  | 2320   |
| –      | T4                                 | TP1           | F-A, S-A               | Category A               | SGG10   | Colourless liquids. Immiscible with water. Toxic if swallowed, by skin contact or by inhalation.  | 2321   |
| –      | T7                                 | TP2           | F-A, S-A               | Category A<br>SW1<br>SW2 | SGG10   | Colourless liquid. Immiscible with water. When heated, develops toxic and irritant gases such as phosgene and hydrogen chloride and may also explode. Toxic if swallowed, by skin contact or by inhalation.   | 2322   |
| –      | T2                                 | TP1           | F-E, S-D               | Category A               | –   | Colourless liquid. Flashpoint: 44°C c.c. Immiscible with water. Irritating to skin, eyes and mucous membranes.  | 2323   |
| –      | T4                                 | TP1           | F-E, S-D               | Category A               | –   | Colourless liquid. Immiscible with water.   | 2324   |
| –      | T2                                 | TP2           | F-E, S-D               | Category A               | –   | Colourless liquid. Flashpoint: 44°C c.c. Immiscible with water. Harmful by inhalation.  | 2325   |
| –      | T4                                 | TP1           | F-A, S-B               | Category A               | SG35  | Colourless, slightly hygroscopic, combustible liquid with a slight amine odour. Immiscible with water. Causes burns to skin, eyes and mucous membranes.   | 2326   |



Part 3 – Dangerous Goods List, special provisions and exceptions

Chapter 3.2 – Dangerous Goods List

| UN No. | Proper shipping name (PSN)          | Class or division | Subsidiary hazard(s) | Packing group  | Special provisions | Limited and excepted quantity provisions |                     | Packing      |              | IBC           |               |
|--------|-------------------------------------|-------------------|----------------------|----------------|--------------------|--|---------------------|--------------|--------------|---------------|---------------|
|        |                                     |                   |                      |                |                    | Limited quantities                       | Excepted quantities | Instructions | Provisions   | Instructions  | Provisions    |
| (1)    | (2)<br>3.1.2                        | (3)<br>2.0        | (4)<br>2.0           | (5)<br>2.0.1.3 | (6)<br>3.3         | (7a)<br>3.4                              | (7b)<br>3.5         | (8)<br>4.1.4 | (9)<br>4.1.4 | (10)<br>4.1.4 | (11)<br>4.1.4 |
| 2327   | TRIMETHYLHEXAMETHYLENE-DIAMINES     | 8                 | –                    | III            | –                  | 5 L                                      | E1                  | P001<br>LP01 | –            | IBC03         | –             |
| 2328   | TRIMETHYLHEXAMETHYLENE DIISOCYANATE | 6.1               | –                    | III            | –                  | 5 L                                      | E1                  | P001<br>LP01 | –            | IBC03         | –             |
| 2329   | TRIMETHYL PHOSPHITE                 | 3                 | –                    | III            | –                  | 5 L                                      | E1                  | P001<br>LP01 | –            | IBC03         | –             |
| 2330   | UNDECANE                            | 3                 | –                    | III            | –                  | 5 L                                      | E1                  | P001<br>LP01 | –            | IBC03         | –             |
| 2331   | ZINC CHLORIDE, ANHYDROUS            | 8                 | –<br>P               | III            | –                  | 5 kg                                     | E1                  | P002<br>LP02 | –            | IBC08         | B3            |
| 2332   | ACETALDEHYDE OXIME                  | 3                 | –                    | III            | –                  | 5 L                                      | E1                  | P001<br>LP01 | –            | IBC03         | –             |
| 2333   | ALLYL ACETATE                       | 3                 | 6.1                  | II             | –                  | 1 L                                      | E2                  | P001         | –            | IBC02         | –             |
| 2334   | ALLYLAMINE                          | 6.1               | 3                    | I              | 354                | 0  | E0                  | P602         | –            | –             | –             |
| 2335   | ALLYL ETHYL ETHER                   | 3                 | 6.1                  | II             | –                  | 1 L                                      | E2                  | P001         | –            | IBC02         | –             |
| 2336   | ALLYL FORMATE                       | 3                 | 6.1                  | I              | –                  | 0  | E0                  | P001         | –            | –             | –             |
| 2337   | PHENYL MERCAPTAN                    | 6.1               | 3                    | I              | 354                | 0  | E0                  | P602         | –            | –             | –             |
| 2338   | BENZOTRIFLUORIDE                    | 3                 | –                    | II             | –                  | 1 L                                      | E2                  | P001         | –            | IBC02         | –             |
| 2339   | 2-BROMOBUTANE                       | 3                 | –                    | II             | –                  | 1 L                                      | E2                  | P001         | –            | IBC02         | –             |
| 2340   | 2-BROMOETHYL ETHYL ETHER            | 3                 | –                    | II             | –                  | 1 L                                      | E2                  | P001         | –            | IBC02         | –             |
| 2341   | 1-BROMO-3-METHYLBUTANE              | 3                 | –                    | III            | –                  | 5 L                                      | E1                  | P001<br>LP01 | –            | IBC03         | –             |
| 2342   | BROMOMETHYLPROPANES                 | 3                 | –                    | II             | –                  | 1 L                                      | E2                  | P001         | –            | IBC02         | –             |
| 2343   | 2-BROMOPENTANE                      | 3                 | –                    | II             | –                  | 1 L                                      | E2                  | P001         | –            | IBC02         | –             |
| 2344   | BROMOPROPANES                       | 3                 | –                    | II             | –                  | 1 L                                      | E2                  | P001         | –            | IBC02         | –             |
| 2344   | BROMOPROPANES                       | 3                 | –                    | III            | 223                | 5 L                                      | E1                  | P001<br>LP01 | –            | IBC03         | –             |

| UN No. | Portable tanks and bulk containers |               | EmS                    | Stowage and handling    | Segregation                  | Properties and observations  | UN No. |
|--------|------------------------------------|---------------|------------------------|-------------------------|------------------------------|--|--------|
|        | Tank instructions                  | Provisions    |                        |                         |                              |  |        |
| (12)   | (13)<br>4.2.5<br>4.3               | (14)<br>4.2.5 | (15)<br>5.4.3.4<br>7.8 | (16a)<br>7.1<br>7.3–7.7 | (16b)<br>7.2–7.7             | (17)   | (18)   |
| –      | T4                                 | TP1           | F-A, S-B               | Category A              | SG35                         | Colourless, slightly hygroscopic, combustible liquids. Miscible with water. Irritating to skin, eyes and mucous membranes.   | 2327   |
| –      | T4                                 | TP2<br>TP13   | F-A, S-A               | Category B              | –                            | Colourless or yellowish liquid. Reacts with water, evolving carbon dioxide. Toxic if swallowed, by skin contact or by inhalation. Irritating to skin, eyes and mucous membranes.   | 2328   |
| –      | T2                                 | TP1           | F-E, S-D               | Category A              | –                            | Colourless liquid. Flashpoint: 23°C c.c. Immiscible with water. Irritating to skin, eyes and mucous membranes.   | 2329   |
| –      | T2                                 | TP1           | F-E, S-E               | Category A              | –                            | Colourless liquid. Flashpoint: 60°C c.c. Immiscible with water.  | 2330   |
| –      | T1                                 | TP33          | F-A, S-B               | Category A              | SGG1<br>SGG7<br>SG36<br>SG49 | White, deliquescent crystals. Soluble in water. Dust causes burns to skin, eyes and mucous membranes.  | 2331   |
| –      | T4                                 | TP1           | F-E, S-D               | Category A              | –                            | Colourless liquid. Flashpoint: 40°C c.c. Explosive limits: 4.2% to 52%. Freezing point 12°C. Miscible with water. Irritating to skin, eyes and mucous membranes.   | 2332   |
| –      | T7                                 | TP1<br>TP13   | F-E, S-D               | Category E<br>SW2       | –                            | Colourless liquid. Flashpoint: 7°C c.c. Partially miscible with water. Toxic if swallowed, by skin contact or by inhalation. Harmful if swallowed.   | 2333   |
| –      | T20                                | TP2<br>TP13   | F-E, S-D               | Category D<br>SW2       | SG35                         | Colourless to light yellow volatile liquid with a pungent odour. Flashpoint: –29°C c.c. Explosive limits: 2.2% to 22%. Boiling range: 55°C to 58°C. Miscible with water. When involved in a fire, evolves highly toxic gases. Highly toxic if swallowed, by skin contact or by inhalation. | 2334   |
| –      | T7                                 | TP1<br>TP13   | F-E, S-D               | Category E<br>SW2       | –                            | Colourless liquid. Flashpoint: –11°C c.c. Vapour heavier than air. Immiscible with water. Narcotic. Toxic if swallowed, by skin contact or by inhalation.  | 2335   |
| –      | T14                                | TP2<br>TP13   | F-E, S-D               | Category E<br>SW2       | –                            | Colourless liquid. Immiscible with water. Highly toxic if swallowed, by skin contact or by inhalation.   | 2336   |
| –      | T20                                | TP2<br>TP13   | F-E, S-D               | Category D<br>SW2       | SG35                         | Colourless flammable liquid with a foul odour. Flashpoint: 50°C c.c. Immiscible with water. In contact with acids or when involved in a fire, evolves highly toxic sulphurous fumes. Highly toxic if swallowed, by skin contact or by inhalation.  | 2337   |
| –      | T4                                 | TP1           | F-E, S-D               | Category B<br>SW2       | –                            | Colourless liquid with an aromatic odour. Flashpoint: 12°C c.c. Lower explosive limit: 2.1%. Immiscible with water. On contact with moisture or air evolves hydrogen fluoride, which is a toxic and corrosive gas. Harmful by inhalation. Irritating to skin, eyes and mucous membranes.   | 2338   |
| –      | T4                                 | TP1           | F-E, S-D               | Category B<br>SW2       | SGG10                        | Colourless liquid with a pleasant odour. Flashpoint: 21°C c.c. Immiscible with water. When involved in a fire, evolves toxic fumes. Narcotic.  | 2339   |
| –      | T4                                 | TP1           | F-E, S-D               | Category B<br>SW2       | –                            | Colourless liquid with an ethereal odour. Partially miscible with water. Harmful by inhalation.  | 2340   |
| –      | T2                                 | TP1           | F-E, S-D               | Category A              | SGG10                        | Colourless liquid. Flashpoint: 23°C to 32°C c.c. Immiscible with water.  | 2341   |
| –      | T4                                 | TP1           | F-E, S-D               | Category B              | SGG10                        | Colourless liquids. Immiscible with water. Harmful by inhalation.  | 2342   |
| –      | T4                                 | TP1           | F-E, S-D               | Category B              | SGG10                        | Colourless or yellow liquid with a strong odour. Flashpoint: 21°C c.c. Immiscible with water. Harmful by inhalation.   | 2343   |
| –      | T4                                 | TP1           | F-E, S-D               | Category B<br>SW2       | SGG10                        | Colourless liquids. Immiscible with water. When involved in a fire, evolve toxic fumes. Harmful by inhalation.   | 2344   |
| –      | T2                                 | TP1           | F-E, S-D               | Category A              | SGG10                        | See entry above.   | 2344   |

Part 3 – Dangerous Goods List, special provisions and exceptions

Chapter 3.2 – Dangerous Goods List

| UN No. | Proper shipping name (PSN)    | Class or division | Subsidiary hazard(s) | Packing group  | Special provisions | Limited and excepted quantity provisions |                     | Packing      |              | IBC           |               |
|--------|-------------------------------|-------------------|----------------------|----------------|--------------------|--|---------------------|--------------|--------------|---------------|---------------|
|        |                               |                   |                      |                |                    | Limited quantities                       | Excepted quantities | Instructions | Provisions   | Instructions  | Provisions    |
| (1)    | (2)<br>3.1.2                  | (3)<br>2.0        | (4)<br>2.0           | (5)<br>2.0.1.3 | (6)<br>3.3         | (7a)<br>3.4                              | (7b)<br>3.5         | (8)<br>4.1.4 | (9)<br>4.1.4 | (10)<br>4.1.4 | (11)<br>4.1.4 |
| 2345   | 3-BROMOPROPYNE                | 3                 | –                    | II             | 905                | 1 L                                      | E2                  | P001         | –            | IBC02         | –             |
| 2346   | BUTANEDIONE                   | 3                 | –                    | II             | –                  | 1 L                                      | E2                  | P001         | –            | IBC02         | –             |
| 2347   | BUTYL MERCAPTAN               | 3                 | –                    | II             | –                  | 1 L                                      | E2                  | P001         | –            | IBC02         | –             |
| 2348   | BUTYL ACRYLATES, STABILIZED   | 3                 | –                    | III            | 386                | 5 L                                      | E1                  | P001<br>LP01 | –            | IBC03         | –             |
| 2350   | BUTYL METHYL ETHER            | 3                 | –                    | II             | –                  | 1 L                                      | E2                  | P001         | –            | IBC02         | –             |
| 2351   | BUTYL NITRITES                | 3                 | –                    | II             | –                  | 1 L                                      | E2                  | P001         | –            | IBC02         | –             |
| 2351   | BUTYL NITRITES                | 3                 | –                    | III            | 223                | 5 L                                      | E1                  | P001<br>LP01 | –            | IBC03         | –             |
| 2352   | BUTYL VINYL ETHER, STABILIZED | 3                 | –                    | II             | 386                | 1 L                                      | E2                  | P001         | –            | IBC02         | –             |
| 2353   | BUTYRYL CHLORIDE              | 3                 | 8                    | II             | –                  | 1 L                                      | E2                  | P001         | –            | IBC02         | B20           |
| 2354   | CHLOROMETHYL ETHYL ETHER      | 3                 | 6.1                  | II             | –                  | 1 L                                      | E2                  | P001         | –            | IBC02         | –             |
| 2356   | 2-CHLOROPROPANE               | 3                 | –                    | I              | –                  | 0  | E3                  | P001         | –            | –             | –             |
| 2357   | CYCLOHEXYLAMINE               | 8                 | 3                    | II             | –                  | 1 L                                      | E2                  | P001         | –            | IBC02         | –             |
| 2358   | CYCLOOCTATETRAENE             | 3                 | –                    | II             | –                  | 1 L                                      | E2                  | P001         | –            | IBC02         | –             |
| 2359   | DIALLYLAMINE                  | 3                 | 6.1/8                | II             | –                  | 1 L                                      | E2                  | P001         | –            | IBC99         | –             |
| 2360   | DIALLYL ETHER                 | 3                 | 6.1                  | II             | –                  | 1 L                                      | E2                  | P001         | –            | IBC02         | –             |
| 2361   | DIISOBUTYLAMINE               | 3                 | 8                    | III            | –                  | 5 L                                      | E1                  | P001         | –            | IBC03         | –             |

| UN No. | Portable tanks and bulk containers |               | EmS                    | Stowage and handling     | Segregation          | Properties and observations  | UN No. |
|--------|------------------------------------|---------------|------------------------|--------------------------|----------------------|--|--------|
|        | Tank instructions                  | Provisions    |                        |                          |                      |  |        |
| (12)   | (13)<br>4.2.5<br>4.3               | (14)<br>4.2.5 | (15)<br>5.4.3.4<br>7.8 | (16a)<br>7.1<br>7.3–7.7  | (16b)<br>7.2–7.7     | (17)   | (18)   |
| –      | T4                                 | TP1           | F-E, S-D               | Category D<br>SW2        | –                    | Colourless to light amber liquid with a sharp odour. Flashpoint: 10°C c.c. Lower explosive limit: 3%. Vapour much heavier than air (4.1). The pure product is shock-sensitive and decomposes with explosive violence, and the possibility of detonation, when heated under confinement. Can be ignited by impact. Immiscible with water. Harmful by inhalation. Irritating to skin, eyes and mucous membranes. Causes tears. | 2345   |
| –      | T4                                 | TP1           | F-E, S-D               | Category B               | –                    | Greenish-yellow liquid with a strong odour. Flashpoint: 6°C c.c. Miscible with water.  | 2346   |
| –      | T4                                 | TP1           | F-E, S-D               | Category B               | SG35<br>SG50<br>SG57 | Colourless liquids with a foul odour. <i>tertiary</i> -BUTYL MERCAPTAN: flashpoint –26°C c.c. <i>secondary</i> -BUTYL MERCAPTAN: flashpoint –23°C c.c. 1-BUTANETHIOL ( <i>normal</i> -BUTYL MERCAPTAN): flashpoint 12°C c.c. ISOBUTYL MERCAPTAN: flashpoint –9°C c.c. Immiscible with water. On contact with acids, emit highly toxic fumes.   | 2347   |
| –      | T2                                 | TP1           | F-E, S-D               | Category C<br>SW1        | –                    | Colourless liquid with an unpleasant odour. Flashpoint: 36°C to 41°C c.c. Explosive limits: 1.2% to 9.9%. Immiscible with water. Harmful by inhalation. Irritating to skin, eyes and mucous membranes.   | 2348   |
| –      | T4                                 | TP1           | F-E, S-D               | Category B               | –                    | Colourless liquid. Immiscible with water.  | 2350   |
| –      | T4                                 | TP1           | F-E, S-D               | Category B<br>SW2        | –                    | Yellowish, volatile, oily liquids. Partially miscible with water. Decompose on exposure to air, light, water or heat, evolving toxic nitrous fumes. Harmful by inhalation.   | 2351   |
| –      | T2                                 | TP1           | F-E, S-D               | Category A<br>SW2        | –                    | See entry above.   | 2351   |
| –      | T4                                 | TP1           | F-E, S-D               | Category C<br>SW1<br>SW2 | –                    | Colourless, volatile liquid with a sharp ethereal odour. Flashpoint: –9°C c.c. Immiscible with water. Harmful by inhalation. Irritating to skin, eyes and mucous membranes.  | 2352   |
| –      | T8                                 | TP2<br>TP13   | F-E, S-C               | Category C<br>SW2        | SGG1<br>SG36<br>SG49 | Colourless liquid with a pungent odour. Reacts with water, evolving hydrogen chloride, an irritating and corrosive gas apparent as white fumes. In the presence of moisture, highly corrosive to most metals. Causes burns to skin, eyes and mucous membranes.   | 2353   |
| –      | T7                                 | TP1<br>TP13   | F-E, S-D               | Category E<br>SW2        | –                    | Colourless liquid with a pungent odour. Partially miscible with water. Fumes in air, evolving hydrogen chloride, which is an irritating and corrosive gas. Toxic by inhalation. Strong lachrymator.  | 2354   |
| –      | T11                                | TP2<br>TP13   | F-E, S-D               | Category E               | SGG10                | Colourless liquid. Flashpoint: –32°C c.c. Explosive limits: 2.8% to 10.7%. Boiling point: 35°C. Immiscible with water. On contact with heat or flame, emits highly toxic phosgene gas. Can react vigorously with oxidizing materials.  | 2356   |
| –      | T7                                 | TP2           | F-E, S-C               | Category A<br>SW2        | SG35                 | Colourless or yellowish flammable liquid with a fishy odour. Flashpoint: 27°C c.c. Explosive limits: 0.5% to 21.7%. Miscible with water. Harmful by inhalation. Causes burns to skin and eyes. Irritating to mucous membranes.   | 2357   |
| –      | T4                                 | TP1           | F-E, S-D               | Category B               | –                    | Colourless liquid. Freezing point: –4°C. Immiscible with water.  | 2358   |
| –      | T7                                 | TP1           | F-E, S-C               | Category B<br>SW2        | SG5<br>SG8<br>SG35   | Colourless, volatile liquid with a disagreeable odour. Flashpoint: 7°C c.c. Partially miscible with water. Toxic if swallowed, by skin contact or by inhalation. Causes burns to skin, eyes and mucous membranes.  | 2359   |
| –      | T7                                 | TP1<br>TP13   | F-E, S-D               | Category E               | –                    | Colourless, volatile liquid with a perceptible odour. Flashpoint: –11°C c.c. Immiscible with water. Toxic if swallowed, by skin contact or by inhalation.  | 2360   |
| –      | T4                                 | TP1           | F-E, S-C               | Category A               | SG35                 | Colourless liquid with a fishy odour. Flashpoint: 29°C c.c. Immiscible with water. Harmful by inhalation. Causes burns to skin and eyes. Irritating to mucous membranes.   | 2361   |

Part 3 – Dangerous Goods List, special provisions and exceptions

Chapter 3.2 – Dangerous Goods List

| UN No. | Proper shipping name (PSN)     | Class or division | Subsidiary hazard(s) | Packing group  | Special provisions | Limited and excepted quantity provisions |                     | Packing      |              | IBC           |               |
|--------|--------------------------------|-------------------|----------------------|----------------|--------------------|--|---------------------|--------------|--------------|---------------|---------------|
|        |                                |                   |                      |                |                    | Limited quantities                       | Excepted quantities | Instructions | Provisions   | Instructions  | Provisions    |
| (1)    | (2)<br>3.1.2                   | (3)<br>2.0        | (4)<br>2.0           | (5)<br>2.0.1.3 | (6)<br>3.3         | (7a)<br>3.4                              | (7b)<br>3.5         | (8)<br>4.1.4 | (9)<br>4.1.4 | (10)<br>4.1.4 | (11)<br>4.1.4 |
| 2362   | 1,1-DICHLOROETHANE             | 3                 | –                    | II             | –                  | 1 L                                      | E2                  | P001         | –            | IBC02         | –             |
| 2363   | ETHYL MERCAPTAN                | 3                 | –<br>P               | I              | –                  | 0  | E0                  | P001         | –            | –             | –             |
| 2364   | n-PROPYLBENZENE                | 3                 | –                    | III            | –                  | 5 L                                      | E1                  | P001<br>LP01 | –            | IBC03         | –             |
| 2366   | DIETHYL CARBONATE              | 3                 | –                    | III            | –                  | 5 L                                      | E1                  | P001<br>LP01 | –            | IBC03         | –             |
| 2367   | alpha-METHYL-VALERALDEHYDE     | 3                 | –                    | II             | –                  | 1 L                                      | E2                  | P001         | –            | IBC02         | –             |
| 2368   | alpha-PINENE                   | 3                 | –<br>P               | III            | –                  | 5 L                                      | E1                  | P001<br>LP01 | –            | IBC03         | –             |
| 2370   | 1-HEXENE                       | 3                 | –                    | II             | –                  | 1 L                                      | E2                  | P001         | –            | IBC02         | –             |
| 2371   | ISOPENTENES                    | 3                 | –                    | I              | –                  | 0  | E3                  | P001         | –            | –             | –             |
| 2372   | 1,2-DI-(DIMETHYLAMINO) ETHANE  | 3                 | –                    | II             | –                  | 1 L                                      | E2                  | P001         | –            | IBC02         | –             |
| 2373   | DIETHOXYMETHANE                | 3                 | –                    | II             | –                  | 1 L                                      | E2                  | P001         | –            | IBC02         | –             |
| 2374   | 3,3-DIETHOXYPROPENE            | 3                 | –                    | II             | –                  | 1 L                                      | E2                  | P001         | –            | IBC02         | –             |
| 2375   | DIETHYL SULPHIDE               | 3                 | –                    | II             | –                  | 1 L                                      | E2                  | P001         | –            | IBC02         | –             |
| 2376   | 2,3-DIHYDROPYRAN               | 3                 | –                    | II             | –                  | 1 L                                      | E2                  | P001         | –            | IBC02         | –             |
| 2377   | 1,1-DIMETHOXYETHANE            | 3                 | –                    | II             | –                  | 1 L                                      | E2                  | P001         | –            | IBC02         | –             |
| 2378   | 2-DIMETHYLAMINO-ACETONITRILE   | 3                 | 6.1                  | II             | –                  | 1 L                                      | E2                  | P001         | –            | IBC02         | –             |
| 2379   | 1,3-DIMETHYLBUTYLAMINE         | 3                 | 8                    | II             | –                  | 1 L                                      | E2                  | P001         | –            | IBC02         | –             |
| 2380   | DIMETHYLDIETHOXYLSILANE        | 3                 | –                    | II             | –                  | 1 L                                      | E2                  | P001         | –            | IBC02         | –             |
| 2381   | DIMETHYL DISULPHIDE            | 3                 | 6.1<br>P             | II             | –                  | 1 L                                      | E0                  | P001         | –            | IBC02         | –             |
| 2382   | DIMETHYLHYDRAZINE, SYMMETRICAL | 6.1               | 3<br>P               | I              | 354                | 0  | E0                  | P602         | –            | –             | –             |
| 2383   | DIPROPYLAMINE                  | 3                 | 8                    | II             | –                  | 1 L                                      | E2                  | P001         | –            | IBC02         | –             |
| 2384   | DI-n-PROPYL ETHER              | 3                 | –                    | II             | –                  | 1 L                                      | E2                  | P001         | –            | IBC02         | –             |

| UN No. | Portable tanks and bulk containers |               | EmS                    | Stowage and handling    | Segregation           | Properties and observations   | UN No. |
|--------|------------------------------------|---------------|------------------------|-------------------------|-----------------------|---|--------|
|        | Tank instructions                  | Provisions    |                        |                         |                       |   |        |
| (12)   | (13)<br>4.2.5<br>4.3               | (14)<br>4.2.5 | (15)<br>5.4.3.4<br>7.8 | (16a)<br>7.1<br>7.3–7.7 | (16b)<br>7.2–7.7      | (17)  | (18)   |
| –      | T4                                 | TP1           | F-E, S-D               | Category B<br>SW2       | SGG10                 | Colourless liquid with an aromatic, ethereal odour. Flashpoint: –10°C c.c. Lower explosive limit: 5.6%. Immiscible with water. When involved in a fire, emits toxic fumes of phosgene. Harmful by inhalation.   | 2362   |
| –      | T11                                | TP2<br>TP13   | F-E, S-D               | Category E              | SG50<br>SG57          | Volatile liquid with a strong unpleasant odour. Flashpoint: –45°C c.c. Explosive limits: 2.8% to 18.2%. Boiling point: 35°C. Immiscible with water.   | 2363   |
| –      | T2                                 | TP1           | F-E, S-D               | Category A              | –                     | Colourless liquid. Flashpoint: 39°C c.c. Explosive limits: 0.8% to 6%. Immiscible with water.   | 2364   |
| –      | T2                                 | TP1           | F-E, S-D               | Category A              | –                     | Colourless liquid. Flashpoint: 25°C to 31°C c.c. Vapour much heavier than air (4.1). Immiscible with water. Irritating to skin, eyes and mucous membranes.  | 2366   |
| –      | T4                                 | TP1           | F-E, S-D               | Category B              | –                     | Colourless liquid. Flashpoint: 13°C c.c. Immiscible with water. Irritating to skin, eyes and mucous membranes.  | 2367   |
| –      | T2                                 | TP2           | F-E, S-E               | Category A              | –                     | Colourless liquid with an odour of turpentine. Flashpoint: 33°C c.c. Explosive limits: 0.8% to 6%. Immiscible with water. Harmful by inhalation. Irritating to skin, eyes and mucous membranes.   | 2368   |
| –      | T4                                 | TP1           | F-E, S-D               | Category E              | –                     | Colourless liquid. Explosive limits: 1.2% to 6.9%. Immiscible with water.   | 2370   |
| –      | T11                                | TP2           | F-E, S-D               | Category E              | –                     | Colourless, volatile liquid with a disagreeable odour. Flashpoint: below –18°C c.c. Immiscible with water. Irritating to skin, eyes and mucous membranes.   | 2371   |
| –      | T4                                 | TP1           | F-E, S-D               | Category B              | –                     | Colourless liquid. Flashpoint: 21°C c.c. Miscible with water. Irritability to skin, eyes and mucous membranes.  | 2372   |
| –      | T4                                 | TP1           | F-E, S-D               | Category B              | –                     | Colourless liquid. Flashpoint: below –5°C c.c. Miscible with water.   | 2373   |
| –      | T4                                 | TP1           | F-E, S-D               | Category B              | –                     | Colourless liquid. Flashpoint: 15°C c.c. Partially miscible with water. Harmful by inhalation.  | 2374   |
| –      | T7                                 | TP1<br>TP13   | F-E, S-D               | Category E              | –                     | Colourless, volatile liquid with an odour of garlic. Flashpoint: –10°C c.c. Immiscible with water.  | 2375   |
| –      | T4                                 | TP1           | F-E, S-D               | Category B              | –                     | Colourless, volatile liquid with an ethereal odour. Flashpoint: –16°C c.c. Miscible with water.   | 2376   |
| –      | T7                                 | TP1           | F-E, S-D               | Category B              | –                     | Colourless liquid with a strong aromatic odour. Miscible with water.  | 2377   |
| –      | T7                                 | TP1           | F-E, S-D               | Category A<br>SW2       | SG35                  | Colourless liquid. Flashpoint: 35°C c.c. Immiscible with water. On contact with water and acids, evolves toxic fumes. Toxic if swallowed, by skin contact or by inhalation.   | 2378   |
| –      | T7                                 | TP1           | F-E, S-C               | Category B              | SGG18<br>SG35         | Colourless liquid with an ammonia-like odour. Flashpoint: 9°C to 13°C c.c. Immiscible with water. Reacts violently with acids. Harmful by inhalation. Causes burns to skin and eyes. Irritating to mucous membranes.                                      | 2379   |
| –      | T4                                 | TP1           | F-E, S-D               | Category B              | –                     | Colourless liquid. Flashpoint: 13°C c.c. Miscible with water. Irritating to skin, eyes and mucous membranes.  | 2380   |
| –      | T7                                 | TP2<br>TP13   | F-E, S-D               | Category B<br>SW2       | –                     | Yellow liquid with an unpleasant odour. Flashpoint: 15°C c.c. Immiscible with water. When involved in a fire, evolves toxic gases. Toxic if swallowed, by skin contact or by inhalation.  | 2381   |
| –      | T20                                | TP2<br>TP13   | F-E, S-D               | Category D<br>SW2       | SGG18<br>SG17<br>SG35 | Colourless, flammable, volatile liquid with an ammonia-like odour. Miscible with water. Reacts violently with acids. May react dangerously with oxidizing substances. Flashpoint: –17°C c.c. Highly toxic if swallowed, by skin contact or by inhalation. | 2382   |
| –      | T7                                 | TP1           | F-E, S-C               | Category B<br>SW1       | SG35                  | Colourless liquid with a fishy odour. Flashpoint: 7°C c.c. Immiscible with water. Harmful by inhalation. Causes burns to skin, eyes and mucous membranes.   | 2383   |
| –      | T4                                 | TP1           | F-E, S-D               | Category B              | –                     | Colourless liquid. Flashpoint (pure product): –21°C c.c. Lower explosive limit: 1.7%. Immiscible with water.  | 2384   |

Part 3 – Dangerous Goods List, special provisions and exceptions

Chapter 3.2 – Dangerous Goods List

| UN No. | Proper shipping name (PSN)      | Class or division | Subsidiary hazard(s) | Packing group  | Special provisions | Limited and excepted quantity provisions |                     | Packing      |              | IBC           |               |
|--------|---------------------------------|-------------------|----------------------|----------------|--------------------|--|---------------------|--------------|--------------|---------------|---------------|
|        |                                 |                   |                      |                |                    | Limited quantities                       | Excepted quantities | Instructions | Provisions   | Instructions  | Provisions    |
| (1)    | (2)<br>3.1.2                    | (3)<br>2.0        | (4)<br>2.0           | (5)<br>2.0.1.3 | (6)<br>3.3         | (7a)<br>3.4                              | (7b)<br>3.5         | (8)<br>4.1.4 | (9)<br>4.1.4 | (10)<br>4.1.4 | (11)<br>4.1.4 |
| 2385   | ETHYL ISOBUTYRATE               | 3                 | –                    | II             | –                  | 1 L                                      | E2                  | P001         | –            | IBC02         | –             |
| 2386   | 1-ETHYLPIPERIDINE               | 3                 | 8                    | II             | –                  | 1 L                                      | E2                  | P001         | –            | IBC02         | –             |
| 2387   | FLUOROBENZENE                   | 3                 | –                    | II             | –                  | 1 L                                      | E2                  | P001         | –            | IBC02         | –             |
| 2388   | FLUOROTOLUENES                  | 3                 | –                    | II             | –                  | 1 L                                      | E2                  | P001         | –            | IBC02         | –             |
| 2389   | FURAN                           | 3                 | –                    | I              | –                  | 0  | E3                  | P001         | –            | –             | –             |
| 2390   | 2-IODOBUTANE                    | 3                 | –                    | II             | –                  | 1 L                                      | E2                  | P001         | –            | IBC02         | –             |
| 2391   | IODOMETHYLPROPANES              | 3                 | –                    | II             | –                  | 1 L                                      | E2                  | P001         | –            | IBC02         | –             |
| 2392   | IODOPROPANES                    | 3                 | –                    | III            | –                  | 5 L                                      | E1                  | P001<br>LP01 | –            | IBC03         | –             |
| 2393   | ISOBUTYL FORMATE                | 3                 | –                    | II             | –                  | 1 L                                      | E2                  | P001         | –            | IBC02         | –             |
| 2394   | ISOBUTYL PROPIONATE             | 3                 | –                    | III            | –                  | 5 L                                      | E1                  | P001<br>LP01 | –            | IBC03         | –             |
| 2395   | ISOBUTYRYL CHLORIDE             | 3                 | 8                    | II             | –                  | 1 L                                      | E2                  | P001         | –            | IBC02         | –             |
| 2396   | METHACRYLALDEHYDE, STABILIZED   | 3                 | 6.1                  | II             | 386                | 1 L                                      | E2                  | P001         | –            | IBC02         | –             |
| 2397   | 3-METHYLBUTAN-2-ONE             | 3                 | –                    | II             | –                  | 1 L                                      | E2                  | P001         | –            | IBC02         | –             |
| 2398   | METHYL <i>tert</i> -BUTYL ETHER | 3                 | –                    | II             | –                  | 1 L                                      | E2                  | P001         | –            | IBC02         | –             |
| 2399   | 1-METHYLPIPERIDINE              | 3                 | 8                    | II             | –                  | 1 L                                      | E2                  | P001         | –            | IBC02         | –             |
| 2400   | METHYL ISOVALERATE              | 3                 | –                    | II             | –                  | 1 L                                      | E2                  | P001         | –            | IBC02         | –             |
| 2401   | PIPERIDINE                      | 8                 | 3                    | I              | –                  | 0  | E0                  | P001         | –            | –             | –             |
| 2402   | PROPANETHIOLS                   | 3                 | –                    | II             | –                  | 1 L                                      | E2                  | P001         | –            | IBC02         | –             |
| 2403   | ISOPROPENYL ACETATE             | 3                 | –                    | II             | –                  | 1 L                                      | E2                  | P001         | –            | IBC02         | –             |
| 2404   | PROPIONITRILE                   | 3                 | 6.1                  | II             | –                  | 1 L                                      | E0                  | P001         | –            | IBC02         | –             |
| 2405   | ISOPROPYL BUTYRATE              | 3                 | –                    | III            | –                  | 5 L                                      | E1                  | P001<br>LP01 | –            | IBC03         | –             |

| UN No. | Portable tanks and bulk containers |               | EmS                    | Stowage and handling     | Segregation          | Properties and observations  | UN No. |
|--------|------------------------------------|---------------|------------------------|--------------------------|----------------------|--|--------|
|        | Tank instructions                  | Provisions    |                        |                          |                      |  |        |
| (12)   | (13)<br>4.2.5<br>4.3               | (14)<br>4.2.5 | (15)<br>5.4.3.4<br>7.8 | (16a)<br>7.1<br>7.3–7.7  | (16b)<br>7.2–7.7     | (17)   | (18)   |
| –      | T4                                 | TP1           | F-E, S-D               | Category B               | –                    | Colourless, volatile liquid with an aromatic odour. Flashpoint: 21°C c.c. Immiscible with water.   | 2385   |
| –      | T7                                 | TP1           | F-E, S-C               | Category B               | SGG18<br>SG35        | Colourless liquid. Flashpoint: 19°C c.c. Immiscible with water. Reacts violently with acids. Harmful by inhalation. Causes burns to skin, eyes and mucous membranes. May cause lung damage.  | 2386   |
| –      | T4                                 | TP1           | F-E, S-D               | Category B               | SGG10                | Colourless liquid with a benzene odour. Flashpoint: –15°C c.c. Immiscible with water. Harmful by inhalation.   | 2387   |
| –      | T4                                 | TP1           | F-E, S-D               | Category B               | SGG10                | Colourless liquids.<br><i>ortho</i> -FLUOROTOLUENE: flashpoint 9°C c.c.<br><i>meta</i> -FLUOROTOLUENE: flashpoint 12°C c.c.<br><i>para</i> -FLUOROTOLUENE: flashpoint 10°C c.c.<br>Immiscible with water.  | 2388   |
| –      | T12                                | TP2<br>TP13   | F-E, S-D               | Category E<br>SW2        | –                    | Colourless liquid with a strong odour. Flashpoint: below –18°C c.c. Explosive limits: 1.3% to 14.3%. Boiling point: 31°C. Immiscible with water. Harmful if swallowed, by skin contact or by inhalation.   | 2389   |
| –      | T4                                 | TP1           | F-E, S-D               | Category B               | SGG10                | Colourless liquid. Flashpoint: 21°C c.c. Immiscible with water.  | 2390   |
| –      | T4                                 | TP1           | F-E, S-D               | Category B               | SGG10                | Colourless liquids. Immiscible with water.   | 2391   |
| –      | T2                                 | TP1           | F-E, S-D               | Category A               | SGG10                | Colourless liquids.<br>1-IODOPROPANE: flashpoint 34°C c.c.<br>2-IODOPROPANE: flashpoint approx. 25°C c.c.<br>Immiscible with water.  | 2392   |
| –      | T4                                 | TP1           | F-E, S-D               | Category B               | –                    | Colourless liquid. Flashpoint: 5°C c.c. Explosive limits: 1.7% to 8%. Irritating to skin, eyes and mucous membranes.   | 2393   |
| –      | T2                                 | TP1           | F-E, S-D               | Category B               | –                    | Colourless liquid. Flashpoint: 31°C c.c. Immiscible with water.  | 2394   |
| –      | T7                                 | TP2           | F-E, S-C               | Category C<br>SW2        | SGG1<br>SG36<br>SG49 | Colourless liquid with a pungent odour. Reacts with water, evolving hydrogen chloride, an irritating and corrosive gas apparent as white fumes. In the presence of moisture, highly corrosive to most metals. Causes burns to skin, eyes and mucous membranes. | 2395   |
| –      | T7                                 | TP1<br>TP13   | F-E, S-D               | Category D<br>SW1<br>SW2 | –                    | Colourless liquid. Flashpoint: 2°C c.c. Miscible with water. Toxic by inhalation. Irritating to skin, eyes and mucous membranes.   | 2396   |
| –      | T4                                 | TP1           | F-E, S-D               | Category B               | –                    | Colourless liquid. Flashpoint: –3°C c.c. Explosive limits: 1.5% to 8%. Immiscible with water.  | 2397   |
| –      | T7                                 | TP1           | F-E, S-D               | Category E               | –                    | Colourless liquid. Flashpoint: below –18°C c.c. Explosive limits: 1.7% to 8.4%. Boiling point: 55°C. Immiscible with water.  | 2398   |
| –      | T7                                 | TP1           | F-E, S-C               | Category B               | SGG18<br>SG35        | Colourless liquid. Flashpoint: 3°C c.c. Miscible with water. Reacts violently with acids. Harmful by inhalation. Causes burns to skin, eyes and mucous membranes.  | 2399   |
| –      | T4                                 | TP1           | F-E, S-D               | Category B               | –                    | Colourless liquid. Immiscible with water.  | 2400   |
| –      | T10                                | TP2           | F-E, S-C               | Category D               | SGG18<br>SG35        | Colourless liquid with a fish-like odour. Miscible with water. Reacts violently with acids. Solution in water is a strong alkali and is corrosive. When involved in fire, evolves toxic nitrous fumes.   | 2401   |
| –      | T4                                 | TP1<br>TP13   | F-E, S-D               | Category E               | SG50<br>SG57         | Colourless or yellowish liquids with a strong unpleasant odour. Flashpoint: below –18°C c.c. Boiling range: 53°C to 67°C. Immiscible with water.   | 2402   |
| –      | T4                                 | TP1           | F-E, S-D               | Category B               | –                    | Colourless liquid. Flashpoint: 10°C c.c. Immiscible with water.  | 2403   |
| –      | T7                                 | TP1<br>TP13   | F-E, S-D               | Category E<br>SW2        | –                    | Colourless, volatile liquid with an ether-like odour. Flashpoint: 2°C c.c. Lower explosive limit: 3.1%. Miscible with water. When involved in a fire, evolves highly toxic cyanide fumes. Toxic if swallowed, by skin contact or by inhalation.                | 2404   |
| –      | T2                                 | TP1           | F-E, S-D               | Category A               | –                    | Colourless liquid. Flashpoint: 25°C c.c. Immiscible with water. Irritating to skin, eyes and mucous membranes.   | 2405   |



Part 3 – Dangerous Goods List, special provisions and exceptions

Chapter 3.2 – Dangerous Goods List

| UN No. | Proper shipping name (PSN)                   | Class or division | Subsidiary hazard(s) | Packing group  | Special provisions | Limited and excepted quantity provisions |                     | Packing      |              | IBC           |               |
|--------|--|-------------------|----------------------|----------------|--------------------|--|---------------------|--------------|--------------|---------------|---------------|
|        |  |                   |                      |                |                    | Limited quantities                       | Excepted quantities | Instructions | Provisions   | Instructions  | Provisions    |
| (1)    | (2)<br>3.1.2                                 | (3)<br>2.0        | (4)<br>2.0           | (5)<br>2.0.1.3 | (6)<br>3.3         | (7a)<br>3.4                              | (7b)<br>3.5         | (8)<br>4.1.4 | (9)<br>4.1.4 | (10)<br>4.1.4 | (11)<br>4.1.4 |
| 2406   | ISOPROPYL ISOBUTYRATE                        | 3                 | –                    | II             | –                  | 1 L                                      | E2                  | P001         | –            | IBC02         | –             |
| 2407   | ISOPROPYL CHLOROFORMATE                      | 6.1               | 3/8                  | I              | 354                | 0  | E0                  | P602         | –            | –             | –             |
| 2409   | ISOPROPYL PROPIONATE                         | 3                 | –                    | II             | –                  | 1 L                                      | E2                  | P001         | –            | IBC02         | –             |
| 2410   | 1,2,3,6-TETRAHYDROPYRIDINE                   | 3                 | –                    | II             | –                  | 1 L                                      | E2                  | P001         | –            | IBC02         | –             |
| 2411   | BUTYRONITRILE                                | 3                 | 6.1                  | II             | –                  | 1 L                                      | E2                  | P001         | –            | IBC02         | –             |
| 2412   | TETRAHYDROTHIOPHENE                          | 3                 | –                    | II             | –                  | 1 L                                      | E2                  | P001         | –            | IBC02         | –             |
| 2413   | TETRAPROPYL ORTHOTITANATE                    | 3                 | –                    | III            | –                  | 5 L                                      | E1                  | P001<br>LP01 | –            | IBC03         | –             |
| 2414   | THIOPHENE                                    | 3                 | –                    | II             | –                  | 1 L                                      | E2                  | P001         | –            | IBC02         | –             |
| 2416   | TRIMETHYL BORATE                             | 3                 | –                    | II             | –                  | 1 L                                      | E2                  | P001         | –            | IBC02         | –             |
| 2417   | CARBONYL FLUORIDE                            | 2.3               | 8                    | –              | –                  | 0  | E0                  | P200         | –            | –             | –             |
| 2418   | SULPHUR TETRAFLUORIDE                        | 2.3               | 8                    | –              | –                  | 0  | E0                  | P200         | –            | –             | –             |
| 2419   | BROMOTRIFLUOROETHYLENE                       | 2.1               | –                    | –              | –                  | 0  | E0                  | P200         | –            | –             | –             |
| 2420   | HEXAFLUOROACETONE                            | 2.3               | 8                    | –              | –                  | 0  | E0                  | P200         | –            | –             | –             |
| 2421   | NITROGEN TRIOXIDE                            | 2.3               | 5.1/8                | –              | –                  | 0  | E0                  | P200         | –            | –             | –             |
| 2422   | OCTAFLUOROBUT-2-ENE (REFRIGERANT GAS R 1318) | 2.2               | –                    | –              | –                  | 120 mL                                   | E1                  | P200         | –            | –             | –             |
| 2424   | OCTAFLUOROPROPANE (REFRIGERANT GAS R 218)    | 2.2               | –                    | –              | –                  | 120 mL                                   | E1                  | P200         | –            | –             | –             |

| UN No. | Portable tanks and bulk containers |               | EmS                    | Stowage and handling    | Segregation                        | Properties and observations   | UN No. |
|--------|------------------------------------|---------------|------------------------|-------------------------|------------------------------------|---|--------|
|        | Tank instructions                  | Provisions    |                        |                         |                                    |   |        |
| (12)   | (13)<br>4.2.5<br>4.3               | (14)<br>4.2.5 | (15)<br>5.4.3.4<br>7.8 | (16a)<br>7.1<br>7.3–7.7 | (16b)<br>7.2–7.7                   | (17)  | (18)   |
| –      | T4                                 | TP1           | F-E, S-D               | Category B              | –                                  | Colourless liquid. Flashpoint: 20°C c.c. Immiscible with water. Narcotic. Irritating to skin, eyes and mucous membranes.  | 2406   |
| –      | –                                  | –             | F-E, S-C               | Category D<br>SW2       | SGG1<br>SG5<br>SG8<br>SG36<br>SG49 | Colourless flammable liquid. Flashpoint: 16°C c.c. Decomposed by water, evolving hydrogen chloride, an irritating and corrosive gas apparent as white fumes. In the presence of moisture, corrosive to most metals. Highly toxic if swallowed, by skin contact or by inhalation. Causes burns to skin, eyes and mucous membranes. | 2407   |
| –      | T4                                 | TP1           | F-E, S-D               | Category B              | –                                  | Colourless liquid. Flashpoint: 21°C c.c. Immiscible with water.   | 2409   |
| –      | T4                                 | TP1           | F-E, S-D               | Category B              | –                                  | Colourless liquid. Flashpoint: 16°C c.c. Miscible with water. Harmful by inhalation.  | 2410   |
| –      | T7                                 | TP1<br>TP13   | F-E, S-D               | Category E<br>SW2       | –                                  | Colourless liquid. Flashpoint: 21°C c.c. Lower explosive limit: 1.6%. Immiscible with water. Toxic if swallowed, by skin contact or by inhalation.  | 2411   |
| –      | T4                                 | TP1           | F-E, S-D               | Category B              | –                                  | Colourless liquid with a pleasant odour. Flashpoint: 13°C c.c. Immiscible with water.   | 2412   |
| –      | T4                                 | TP1           | F-E, S-D               | Category A              | –                                  | Colourless liquid. Flashpoint: 38°C c.c.  | 2413   |
| –      | T4                                 | TP1           | F-E, S-D               | Category B<br>SW2       | –                                  | Colourless liquid with an unpleasant odour. Flashpoint: –9°C c.c. Explosive limits: 1.5% to 12.5%. Immiscible with water. Irritating to skin, eyes and mucous membranes.  | 2414   |
| –      | T7                                 | TP1           | F-E, S-D               | Category B              | –                                  | Colourless liquid. Reacts with water, evolving flammable vapours.   | 2416   |
| –      | –                                  | –             | F-C, S-U               | Category D<br>SW2       | –                                  | Non-flammable, toxic and corrosive colourless gas with a pungent odour. Corrosive to glass and to most metals. Corrosive in the presence of water. Much heavier than air (2.3). Highly irritating to skin, eyes and mucous membranes.   | 2417   |
| –      | –                                  | –             | F-C, S-U               | Category D<br>SW2       | SG35                               | Non-flammable, toxic and corrosive, colourless gas with a pungent odour. Reacts with water, moist air or acids to produce toxic and corrosive fumes. Corrosive to glass and to most metals. Much heavier than air (3.7). Highly irritating to skin, eyes and mucous membranes.  | 2418   |
| –      | –                                  | –             | F-D, S-U               | Category B<br>SW2       | –                                  | Liquefied, flammable, colourless gas. Much heavier than air (5.6). Boiling point: –3°C.   | 2419   |
| –      | –                                  | –             | F-C, S-U               | Category D<br>SW2       | –                                  | Non-flammable, toxic and corrosive, colourless, hygroscopic gas with an unpleasant odour. Reacts vigorously with water, evolving heat. Corrosive to glass and to most metals. Fumes in moist air. Much heavier than air (5.7). Highly irritating to skin, eyes and mucous membranes.  | 2420   |
| –      | –                                  | –             | F-C, S-W               | Category D<br>SW2       | SG6<br>SG19                        | Liquefied, non-flammable, toxic and corrosive gas. At lower temperatures, present as a blue liquid. Strong oxidizing agent. Much heavier than air (2.6). Boiling point: 3.5°C. Highly irritating to skin, eyes and mucous membranes.  | 2421   |
| –      | –                                  | –             | F-C, S-V               | Category A              | –                                  | Liquefied, non-flammable, colourless gas. Much heavier than air (6.9). Boiling point: 1.2°C.  | 2422   |
| –      | T50                                | –             | F-C, S-V               | Category A              | –                                  | Liquefied, non-flammable, colourless gas. Much heavier than air (6.6). Boiling point: –36°C.  | 2424   |

Part 3 – Dangerous Goods List, special provisions and exceptions

Chapter 3.2 – Dangerous Goods List

| UN No. | Proper shipping name (PSN)   | Class or division | Subsidiary hazard(s) | Packing group  | Special provisions | Limited and excepted quantity provisions |                     | Packing      |              | IBC           |               |
|--------|--|-------------------|----------------------|----------------|--------------------|--|---------------------|--------------|--------------|---------------|---------------|
|        |  |                   |                      |                |                    | Limited quantities                       | Excepted quantities | Instructions | Provisions   | Instructions  | Provisions    |
| (1)    | (2)<br>3.1.2   | (3)<br>2.0        | (4)<br>2.0           | (5)<br>2.0.1.3 | (6)<br>3.3         | (7a)<br>3.4                              | (7b)<br>3.5         | (8)<br>4.1.4 | (9)<br>4.1.4 | (10)<br>4.1.4 | (11)<br>4.1.4 |
| 2426   | AMMONIUM NITRATE, LIQUID (hot concentrated solution)                               | 5.1               | –                    | –              | 252<br>942         | 0  | E0                  | –            | –            | –             | –             |
| 2427   | POTASSIUM CHLORATE, AQUEOUS SOLUTION   | 5.1               | –                    | II             | –                  | 1 L                                      | E2                  | P504         | –            | IBC02         | –             |
| 2427   | POTASSIUM CHLORATE, AQUEOUS SOLUTION   | 5.1               | –                    | III            | 223                | 5 L                                      | E1                  | P504         | –            | IBC02         | –             |
| 2428   | SODIUM CHLORATE, AQUEOUS SOLUTION  | 5.1               | –                    | II             | –                  | 1 L                                      | E2                  | P504         | –            | IBC02         | –             |
| 2428   | SODIUM CHLORATE, AQUEOUS SOLUTION  | 5.1               | –                    | III            | 223                | 5 L                                      | E1                  | P504         | –            | IBC02         | –             |
| 2429   | CALCIUM CHLORATE, AQUEOUS SOLUTION   | 5.1               | –                    | II             | –                  | 1 L                                      | E2                  | P504         | –            | IBC02         | –             |
| 2429   | CALCIUM CHLORATE, AQUEOUS SOLUTION   | 5.1               | –                    | III            | 223                | 5 L                                      | E1                  | P504         | –            | IBC02         | –             |
| 2430   | ALKYLPHENOLS, SOLID, N.O.S. (including C <sub>2</sub> –C <sub>12</sub> homologues) | 8                 | –                    | I              | –                  | 0  | E0                  | P002         | –            | IBC07         | B1            |
| 2430   | ALKYLPHENOLS, SOLID, N.O.S. (including C <sub>2</sub> –C <sub>12</sub> homologues) | 8                 | –                    | II             | –                  | 1 kg                                     | E2                  | P002         | –            | IBC08         | B4<br>B21     |
| 2430   | ALKYLPHENOLS, SOLID, N.O.S. (including C <sub>2</sub> –C <sub>12</sub> homologues) | 8                 | –                    | III            | 223                | 5 kg                                     | E1                  | P002<br>LP02 | –            | IBC08         | B3            |
| 2431   | ANISIDINES   | 6.1               | –                    | III            | –                  | 5 L                                      | E1                  | P001<br>LP01 | –            | IBC03         | –             |

| UN No. | Portable tanks and bulk containers |                     | EmS                    | Stowage and handling    | Segregation  | Properties and observations   | UN No. |
|--------|------------------------------------|---------------------|------------------------|-------------------------|--|---|--------|
|        | Tank instructions                  | Provisions          |                        |                         |  |   |        |
| (12)   | (13)<br>4.2.5<br>4.3               | (14)<br>4.2.5       | (15)<br>5.4.3.4<br>7.8 | (16a)<br>7.1<br>7.3–7.7 | (16b)<br>7.2–7.7   | (17)  | (18)   |
| –      | T7                                 | TP1<br>TP16<br>TP17 | F-H, S-Q               | Category D              | SGG2<br>SG42<br>SG45<br>SG47<br>SG48<br>SG51<br>SG56<br>SG58<br>SG59<br>SG61 | Hot aqueous solution of not more than 93% ammonium nitrate with not more than 0.2% combustible material (including organic material calculated as carbon) and free from any other added matter, containing at least 7% water, while the maximum content of chloride ions should not exceed 0.02%. May cause fire and explosion in contact with combustible material (e.g. wood, straw, cotton, oil, sugar, etc.), acids, and other class 5.1 substances and burn fiercely. Maximum allowable transport temperature of the solution 140°C. This temperature should be indicated on the transport unit. The acidity (pH) of the cargo when diluted with ten parts of water to one part of cargo, by mass, should be between 5.0 and 7.0. The concentration and temperature of the solution at the time of loading, its percentage of combustible materials and of chlorides, and the contents of free acid should be certified. | 2426   |
| –      | T4                                 | TP1                 | F-H, S-Q               | Category B              | SGG4<br>SG38<br>SG49<br>SG62   | Colourless liquid. When involved in a fire, may cause an explosion. Leakage and subsequent evaporation of the water may present increased dangers as follows:<br>.1 in contact with combustible material (particularly with fibrous material such as jute, cotton or sisal) or sulphur, danger of spontaneous combustion;<br>.2 in contact with ammonium compounds, powdered metals or oils, danger of explosion.   | 2427   |
| –      | T4                                 | TP1                 | F-H, S-Q               | Category B              | SGG4<br>SG38<br>SG49<br>SG62   | See entry above.  | 2427   |
| –      | T4                                 | TP1                 | F-H, S-Q               | Category B              | SGG4<br>SG38<br>SG49<br>SG62   | Colourless liquid. When involved in a fire, may cause an explosion. Leakage and subsequent evaporation of the water may present increased dangers as follows:<br>.1 in contact with combustible material (particularly with fibrous material such as jute, cotton or sisal) or sulphur, danger of spontaneous combustion;<br>.2 in contact with ammonium compounds, powdered metals or oils, danger of explosion.   | 2428   |
| –      | T4                                 | TP1                 | F-H, S-Q               | Category B              | SGG4<br>SG38<br>SG49<br>SG62   | See entry above.  | 2428   |
| –      | T4                                 | TP1                 | F-H, S-Q               | Category B              | SGG4<br>SG38<br>SG49<br>SG62   | Colourless liquid. When involved in a fire, may cause an explosion. Leakage and subsequent evaporation of the water may present increased dangers as follows:<br>.1 in contact with combustible material (particularly with fibrous material such as jute, cotton or sisal) or sulphur, danger of spontaneous combustion;<br>.2 in contact with ammonium compounds, powdered metals or oils, danger of explosion.   | 2429   |
| –      | T4                                 | TP1                 | F-H, S-Q               | Category B              | SGG4<br>SG38<br>SG49<br>SG62   | See entry above.  | 2429   |
| –      | T6                                 | TP33                | F-A, S-B               | Category B              | –  | A wide range of colourless to pale straw-coloured solids with penetrating odours (sometimes camphor-like). Some have low melting points. Insoluble in water. Cause burns to skin, eyes and mucous membranes.  | 2430   |
| –      | T3                                 | TP33                | F-A, S-B               | Category B              | –  | See entry above.  | 2430   |
| –      | T1                                 | TP33                | F-A, S-B               | Category A              | –  | See entry above.  | 2430   |
| –      | T4                                 | TP1                 | F-A, S-A               | Category A              | –  | Reddish or yellowish oily liquid. Immiscible with water. Toxic if swallowed, by skin contact or by inhalation.  | 2431   |

Part 3 – Dangerous Goods List, special provisions and exceptions

Chapter 3.2 – Dangerous Goods List

| UN No. | Proper shipping name (PSN)   | Class or division | Subsidiary hazard(s) | Packing group  | Special provisions | Limited and excepted quantity provisions |                     | Packing      |              | IBC           |               |
|--------|--|-------------------|----------------------|----------------|--------------------|--|---------------------|--------------|--------------|---------------|---------------|
|        |  |                   |                      |                |                    | Limited quantities                       | Excepted quantities | Instructions | Provisions   | Instructions  | Provisions    |
| (1)    | (2)<br>3.1.2   | (3)<br>2.0        | (4)<br>2.0           | (5)<br>2.0.1.3 | (6)<br>3.3         | (7a)<br>3.4                              | (7b)<br>3.5         | (8)<br>4.1.4 | (9)<br>4.1.4 | (10)<br>4.1.4 | (11)<br>4.1.4 |
| 2432   | N,N-DIETHYLANILINE   | 6.1               | –                    | III            | 279                | 5 L                                      | E1                  | P001<br>LP01 | –            | IBC03         | –             |
| 2433   | CHLORONITROTOLUENES, LIQUID  | 6.1               | –<br>P               | III            | –                  | 5 L                                      | E1                  | P001<br>LP01 | –            | IBC03         | –             |
| 2434   | DIBENZYL-DICHLOROSILANE  | 8                 | –                    | II             | –                  | 0  | E0                  | P010         | –            | –             | –             |
| 2435   | ETHYLPHENYL-DICHLOROSILANE   | 8                 | –                    | II             | –                  | 0  | E0                  | P010         | –            | –             | –             |
| 2436   | THIOACETIC ACID  | 3                 | –                    | II             | –                  | 1 L                                      | E2                  | P001         | –            | IBC02         | –             |
| 2437   | METHYLPHENYL-DICHLOROSILANE  | 8                 | –                    | II             | –                  | 0  | E0                  | P010         | –            | –             | –             |
| 2438   | TRIMETHYLACETYL CHLORIDE   | 6.1               | 3/8                  | I              | –                  | 0  | E0                  | P001         | –            | –             | –             |
| 2439   | SODIUM HYDROGENDIFLUORIDE  | 8                 | –                    | II             | –                  | 1 kg                                     | E2                  | P002         | –            | IBC08         | B4<br>B21     |
| 2440   | STANNIC CHLORIDE PENTAHYDRATE  | 8                 | –                    | III            | –                  | 5 kg                                     | E1                  | P002<br>LP02 | –            | IBC08         | B3            |
| 2441   | TITANIUM TRICHLORIDE, PYROPHORIC or TITANIUM TRICHLORIDE MIXTURE, PYROPHORIC | 4.2               | 8                    | I              | –                  | 0  | E0                  | P404         | PP31         | –             | –             |
| 2442   | TRICHLOROACETYL CHLORIDE   | 8                 | –                    | II             | –                  | 0  | E0                  | P001         | –            | –             | –             |
| 2443   | VANADIUM OXYTRICHLORIDE  | 8                 | –                    | II             | –                  | 1 L                                      | E0                  | P001         | –            | IBC02         | –             |
| 2444   | VANADIUM TETRACHLORIDE   | 8                 | –                    | I              | –                  | 0  | E0                  | P802         | –            | –             | –             |
| 2446   | NITROCRESOLS, SOLID  | 6.1               | –                    | III            | –                  | 5 kg                                     | E1                  | P002<br>LP02 | –            | IBC08         | B3            |

| UN No. | Portable tanks and bulk containers |                    | EmS                    | Stowage and handling           | Segregation                        | Properties and observations  | UN No. |
|--------|------------------------------------|--------------------|------------------------|--------------------------------|------------------------------------|--|--------|
|        | Tank instructions                  | Provisions         |                        |                                |                                    |  |        |
| (12)   | (13)<br>4.2.5<br>4.3               | (14)<br>4.2.5      | (15)<br>5.4.3.4<br>7.8 | (16a)<br>7.1<br>7.3–7.7        | (16b)<br>7.2–7.7                   | (17)   | (18)   |
| –      | T4                                 | TP1                | F-A, S-A               | Category A                     | –                                  | Colourless to yellow-brown oily liquid. Combustible. Toxic if swallowed, by skin contact or by inhalation.   | 2432   |
| –      | T4                                 | TP1                | F-A, S-A               | Category A                     | SG6<br>SG8<br>SG10<br>SG12         | Immiscible with water. Oxidizing substance which may explode or burn fiercely when in contact with organic materials. Toxic if swallowed, by skin contact or by inhalation.  | 2433   |
| –      | T10                                | TP2<br>TP7<br>TP13 | F-A, S-B               | Category C<br>SW2              | SGG1<br>SG36<br>SG49               | Colourless liquid with a pungent odour. Reacts violently with water, evolving hydrogen chloride, a corrosive gas apparent as white fumes. When involved in a fire, evolves toxic gases. In the presence of moisture, highly corrosive to most metals. Vapour irritating to skin, eyes and mucous membranes.                                      | 2434   |
| –      | T10                                | TP2<br>TP7<br>TP13 | F-A, S-B               | Category C                     | SGG1<br>SG36<br>SG49               | Colourless liquid with a pungent odour. Reacts with water, evolving hydrogen chloride, a corrosive gas apparent as white fumes. When involved in a fire, evolves toxic gases. In the presence of moisture, highly corrosive to most metals. Causes burns to skin, eyes and mucous membranes.   | 2435   |
| –      | T4                                 | TP1                | F-E, S-D               | Category B                     | –                                  | Colourless or yellow liquid with a pungent odour. Miscible with water. Harmful by inhalation.  | 2436   |
| –      | T10                                | TP2<br>TP7<br>TP13 | F-A, S-B               | Category C<br>SW2              | SGG1<br>SG36<br>SG49               | Colourless liquid. Reacts with water, evolving hydrogen chloride, an irritating and corrosive gas apparent as white fumes. When involved in a fire, evolves toxic gases. In the presence of moisture, highly corrosive to most metals. Causes burns to skin, eyes and mucous membranes.  | 2437   |
| –      | T14                                | TP2<br>TP13        | F-E, S-C               | Category D<br>SW1<br>SW2       | SGG1<br>SG5<br>SG8<br>SG36<br>SG49 | Flammable liquid. Flashpoint: 19°C c.c. Boiling point: 108°C. Reacts with water, evolving hydrogen chloride, a corrosive gas apparent as white fumes. In the presence of moisture, corrosive to most metals. Highly toxic if swallowed, by skin contact or by inhalation. Causes burns to skin, eyes and mucous membranes.                       | 2438   |
| –      | T3                                 | TP33               | F-A, S-B               | Category A<br>SW1<br>SW2<br>H2 | SGG1<br>SG35<br>SG36<br>SG49       | White, crystalline powder. Soluble in water. Decomposed by heat or acids, evolving hydrogen fluoride, a toxic extremely irritating and corrosive gas. In the presence of moisture, highly corrosive to glass, other siliceous materials and most metals. Causes burns to skin, eyes and mucous membranes.  | 2439   |
| –      | T1                                 | TP33               | F-A, S-B               | Category A                     | SGG1<br>SG36<br>SG49               | White, deliquescent solid. Melting point: about 60°C. Soluble in water. In the presence of water, corrosive to most metals. Irritating to skin, eyes and mucous membranes.   | 2440   |
| –      | –                                  | –                  | F-G, S-M               | Category D<br>SW2<br>H1        | SGG7<br>SG26                       | Finely divided, violet, crystalline solid. May ignite on exposure to air or moisture. In the presence of moisture, corrosive to most metals. Causes burns to skin, eyes and mucous membranes.  | 2441   |
| –      | T7                                 | TP2                | F-A, S-B               | Category D<br>SW2              | SGG1<br>SG36<br>SG49               | Liquid with a pungent odour, which fumes in moist air. Reacts violently with water, evolving hydrogen chloride, a corrosive gas apparent as white fumes. When involved in a fire, evolves toxic gases. In the presence of moisture, corrosive to most metals. Liquid and vapours cause burns to skin, eyes and mucous membranes.                 | 2442   |
| –      | T7                                 | TP2                | F-A, S-B               | Category C<br>SW2              | SGG1<br>SG36<br>SG49               | Yellow liquid. Decomposition occurs on exposure to moist air, forming red fumes of vanadic acid and hydrogen chloride, a corrosive gas apparent as white fumes. Reacts with, or dissolves, many organic compounds. In the presence of moisture, corrosive to most metals. Causes burns to skin, eyes and mucous membranes.                       | 2443   |
| –      | T10                                | TP2                | F-A, S-B               | Category C<br>SW2              | SGG1<br>SG36<br>SG49               | Reddish-brown liquid. Decomposes under the influence of light, evolving chlorine, a highly toxic and irritating gas. Reacts violently with water, evolving hydrogen chloride, a corrosive gas apparent as white fumes. In the presence of moisture, corrosive to most metals. Liquid and vapours cause burns to skin, eyes and mucous membranes. | 2444   |
| –      | T1                                 | TP33               | F-A, S-A               | Category A                     | –                                  | Yellow crystals. Melting point: 32°C or above. Slightly soluble in water. Toxic if swallowed, by skin contact or by inhalation.  | 2446   |



Part 3 – Dangerous Goods List, special provisions and exceptions

Chapter 3.2 – Dangerous Goods List

| UN No. | Proper shipping name (PSN)                                      | Class or division | Subsidiary hazard(s) | Packing group  | Special provisions | Limited and excepted quantity provisions |                     | Packing      |              | IBC           |               |
|--------|---|-------------------|----------------------|----------------|--------------------|--|---------------------|--------------|--------------|---------------|---------------|
|        |   |                   |                      |                |                    | Limited quantities                       | Excepted quantities | Instructions | Provisions   | Instructions  | Provisions    |
| (1)    | (2)<br>3.1.2  | (3)<br>2.0        | (4)<br>2.0           | (5)<br>2.0.1.3 | (6)<br>3.3         | (7a)<br>3.4                              | (7b)<br>3.5         | (8)<br>4.1.4 | (9)<br>4.1.4 | (10)<br>4.1.4 | (11)<br>4.1.4 |
| 2447   | PHOSPHORUS, WHITE, MOLTEN                                       | 4.2               | 6.1<br>P             | I              | –                  | 0  | E0                  | –            | –            | –             | –             |
| 2448   | SULPHUR, MOLTEN   | 4.1               | –                    | III            | –                  | 0  | E0                  | –            | –            | IBC01         | –             |
| 2451   | NITROGEN TRIFLUORIDE  | 2.2               | 5.1                  | –              | –                  | 0  | E0                  | P200         | –            | –             | –             |
| 2452   | ETHYLACETYLENE, STABILIZED                                      | 2.1               | –                    | –              | 386                | 0  | E0                  | P200         | –            | –             | –             |
| 2453   | ETHYL FLUORIDE (REFRIGERANT GAS R 161)                          | 2.1               | –                    | –              | –                  | 0  | E0                  | P200         | –            | –             | –             |
| 2454   | METHYL FLUORIDE (REFRIGERANT GAS R 41)                          | 2.1               | –                    | –              | –                  | 0  | E0                  | P200         | –            | –             | –             |
| 2455   | METHYL NITRITE  | 2.2               | –                    | –              | 900                | –  | –                   | –            | –            | –             | –             |
| 2456   | 2-CHLOROPROPENE   | 3                 | –                    | I              | –                  | 0  | E3                  | P001         | –            | –             | –             |
| 2457   | 2,3-DIMETHYLBUTANE  | 3                 | –                    | II             | –                  | 1 L                                      | E2                  | P001         | –            | IBC02         | –             |
| 2458   | HEXADIENES  | 3                 | –                    | II             | –                  | 1 L                                      | E2                  | P001         | –            | IBC02         | –             |
| 2459   | 2-METHYL-1-BUTENE   | 3                 | –                    | I              | –                  | 0  | E3                  | P001         | –            | –             | –             |
| 2460   | 2-METHYL-2-BUTENE   | 3                 | –                    | II             | –                  | 1 L                                      | E2                  | P001         | –            | IBC02         | B8            |
| 2461   | METHYLPENTADIENES   | 3                 | –                    | II             | –                  | 1 L                                      | E2                  | P001         | –            | IBC02         | –             |
| 2463   | ALUMINIUM HYDRIDE   | 4.3               | –                    | I              | –                  | 0  | E0                  | P403         | PP31         | –             | –             |
| 2464   | BERYLLIUM NITRATE   | 5.1               | 6.1                  | II             | –                  | 1 kg                                     | E2                  | P002         | –            | IBC08         | B4<br>B21     |
| 2465   | DICHLOROISOCYANURIC ACID, DRY or DICHLOROISOCYANURIC ACID SALTS | 5.1               | –                    | II             | 135                | 1 kg                                     | E2                  | P002         | –            | IBC08         | B4<br>B21     |
| 2466   | POTASSIUM SUPEROXIDE  | 5.1               | –                    | I              | –                  | 0  | E0                  | P503         | –            | IBC06         | B1            |

| UN No. | Portable tanks and bulk containers |                    | EmS                    | Stowage and handling     | Segregation                           | Properties and observations   | UN No. |
|--------|------------------------------------|--------------------|------------------------|--------------------------|---------------------------------------|---|--------|
|        | Tank instructions                  | Provisions         |                        |                          |                                       |   |        |
| (12)   | (13)<br>4.2.5<br>4.3               | (14)<br>4.2.5      | (15)<br>5.4.3.4<br>7.8 | (16a)<br>7.1<br>7.3–7.7  | (16b)<br>7.2–7.7                      | (17)  | (18)   |
| –      | T21                                | TP3<br>TP7<br>TP26 | F-A, S-M               | Category D               | –                                     | Molten liquid. Melting point: 44°C. Ignites spontaneously in air. Toxic if swallowed, by skin contact or by inhalation. Shipped molten above its melting point.   | 2447   |
| –      | T1                                 | TP3                | F-A, S-H               | Category C               | SG17                                  | Melting point: 119°C. Molten sulphur may contain hydrogen sulphide, which is highly poisonous in low concentrations. When involved in a fire, evolves toxic, very irritating and suffocating gas. Forms explosive and extremely sensitive mixtures with oxidizing substances. Shipped molten above its melting point. | 2448   |
| –      | –                                  | –                  | F-C, S-W               | Category D<br>SW2        | –                                     | Non-flammable, non-toxic, colourless, odourless gas. Strong oxidizing agent; reacts violently with many substances, e.g. grease, oil, etc. Much heavier than air (2.4). May cause slight eye irritation.  | 2451   |
| –      | –                                  | –                  | F-D, S-U               | Category B<br>SW1<br>SW2 | –                                     | Liquefied, flammable, colourless gas with an odour similar to acetylene. Heavier than air (1.9). Boiling point: 8°C. Irritating to skin, eyes and mucous membranes.   | 2452   |
| –      | –                                  | –                  | F-D, S-U               | Category E<br>SW2        | –                                     | Liquefied, flammable, colourless gas. Explosive limits: 5% to 10%. Heavier than air (1.7). Boiling point: –37°C.  | 2453   |
| –      | –                                  | –                  | F-D, S-U               | Category E<br>SW2        | –                                     | Flammable, colourless gas. Heavier than air (1.2).  | 2454   |
| –      | –                                  | –                  | –                      | –                        | –                                     | Transport is prohibited.  | 2455   |
| –      | T11                                | TP2                | F-E, S-D               | Category E               | SGG10                                 | Colourless liquid. Flashpoint: below –18°C c.c. Explosive limits: 2.5% to 12%. Boiling point: 23°C. Immiscible with water. Harmful if swallowed or by inhalation. Irritating to skin, eyes and mucous membranes.  | 2456   |
| –      | T7                                 | TP1                | F-E, S-D               | Category E               | –                                     | Colourless liquid. Flashpoint: –29°C c.c. Explosive limits: 1.2% to 7%. Immiscible with water. Irritating to skin, eyes and mucous membranes. Narcotic in high concentrations.  | 2457   |
| –      | T4                                 | TP1                | F-E, S-D               | Category B               | –                                     | Colourless liquids.<br>1,3-HEXADIENE: flashpoint –3°C c.c.<br>1,4-HEXADIENE: flashpoint –25°C c.c.<br>1,5-HEXADIENE: flashpoint –27°C c.c.<br>2,4-HEXADIENE: flashpoint –7°C c.c.<br>Immiscible with water. Harmful by inhalation. Irritating to skin, eyes and mucous membranes.                                     | 2458   |
| –      | T11                                | TP2                | F-E, S-D               | Category E               | –                                     | Colourless, volatile liquid with a disagreeable odour. Flashpoint: below –18°C c.c. Immiscible with water. Irritating to skin, eyes and mucous membranes.   | 2459   |
| –      | T7                                 | TP1                | F-E, S-D               | Category E               | –                                     | Colourless, volatile liquid with a disagreeable odour. Flashpoint: below –18°C c.c. Immiscible with water. Irritating to skin, eyes and mucous membranes.   | 2460   |
| –      | T4                                 | TP1                | F-E, S-D               | Category E               | –                                     | Colourless liquids. Flashpoint: below –18°C c.c. Immiscible with water. Irritating to skin, eyes and mucous membranes.  | 2461   |
| –      | –                                  | –                  | F-G, S-O               | Category E<br>H1         | SG26                                  | White to grey powder. In contact with water, acids or moisture, evolves hydrogen, which may be ignited by the heat of the reaction.   | 2463   |
| –      | T3                                 | TP33               | F-A, S-Q               | Category A               | –                                     | White or light yellow deliquescent crystals, or fine dust. Mixtures with combustible material are readily ignited and may burn fiercely. Toxic if swallowed, by skin contact or by dust inhalation.   | 2464   |
| –      | T3                                 | TP33               | F-A, S-Q               | Category A<br>H1         | –                                     | White crystalline powder or granules; slightly hygroscopic. Partially soluble in water. Mixtures with combustible material are sensitive to friction and are liable to ignite. Harmful by inhalation. Irritating to skin, eyes and mucous membranes.  | 2465   |
| –      | –                                  | –                  | F-G, S-Q               | Category D<br>H1         | SGG16<br>SG16<br>SG26<br>SG35<br>SG59 | Yellow flakes. Particularly if wetted with small quantities of water, a mixture with combustible material may ignite, following impact or friction. When involved in a fire, or in contact with water or acids, decomposes, evolving oxygen. Highly irritating to skin, eyes and mucous membranes.                    | 2466   |

Part 3 – Dangerous Goods List, special provisions and exceptions

Chapter 3.2 – Dangerous Goods List

| UN No. | Proper shipping name (PSN)   | Class or division | Subsidiary hazard(s) | Packing group  | Special provisions | Limited and excepted quantity provisions |                          | Packing          |                | IBC               |                 |
|--------|--|-------------------|----------------------|----------------|--------------------|--|--------------------------|------------------|----------------|-------------------|-----------------|
|        |  |                   |                      |                |                    | Limited quantities (7a)                  | Excepted quantities (7b) | Instructions (8) | Provisions (9) | Instructions (10) | Provisions (11) |
| (1)    | (2)<br>3.1.2   | (3)<br>2.0        | (4)<br>2.0           | (5)<br>2.0.1.3 | (6)<br>3.3         | (7a)<br>3.4                              | (7b)<br>3.5              | (8)<br>4.1.4     | (9)<br>4.1.4   | (10)<br>4.1.4     | (11)<br>4.1.4   |
| 2468   | TRICHLOROISOCYANURIC ACID, DRY   | 5.1               | –                    | II             | –                  | 1 kg                                     | E2                       | P002             | –              | IBC08             | B4<br>B21       |
| 2469   | ZINC BROMATE   | 5.1               | –                    | III            | –                  | 5 kg                                     | E1                       | P002<br>LP02     | –              | IBC08             | B3              |
| 2470   | PHENYLACETONITRILE, LIQUID   | 6.1               | –                    | III            | –                  | 5 L                                      | E1                       | P001<br>LP01     | –              | IBC03             | –               |
| 2471   | OSMIUM TETROXIDE   | 6.1               | –<br>P               | I              | –                  | 0  | E5                       | P002             | PP30<br>PP31   | IBC07             | B1              |
| 2473   | SODIUM ARSANILATE  | 6.1               | –                    | III            | –                  | 5 kg                                     | E1                       | P002<br>LP02     | –              | IBC08             | B3              |
| 2474   | THIOPHOSGENE   | 6.1               | –                    | I              | 279<br>354         | 0  | E0                       | P602             | –              | –                 | –               |
| 2475   | VANADIUM TRICHLORIDE   | 8                 | –                    | III            | –                  | 5 kg                                     | E1                       | P002<br>LP02     | –              | IBC08             | B3              |
| 2477   | METHYL ISOTHIOCYANATE  | 6.1               | 3                    | I              | 354                | 0  | E0                       | P602             | –              | –                 | –               |
| 2478   | ISOCYANATES, FLAMMABLE, TOXIC, N.O.S. or ISOCYANATE SOLUTION, FLAMMABLE, TOXIC, N.O.S. | 3                 | 6.1                  | II             | 274                | 1 L                                      | E2                       | P001             | PP31           | IBC02             | –               |
| 2478   | ISOCYANATES, FLAMMABLE, TOXIC, N.O.S. or ISOCYANATE SOLUTION, FLAMMABLE, TOXIC, N.O.S. | 3                 | 6.1                  | III            | 223<br>274         | 5 L                                      | E1                       | P001             | PP31           | IBC03             | –               |
| 2480   | METHYL ISOCYANATE  | 6.1               | 3                    | I              | 354                | 0  | E0                       | P601             | –              | –                 | –               |
| 2481   | ETHYL ISOCYANATE   | 6.1               | 3                    | I              | 354                | 0  | E0                       | P602             | –              | –                 | –               |
| 2482   | n-PROPYL ISOCYANATE  | 6.1               | 3                    | I              | 354                | 0  | E0                       | P602             | –              | –                 | –               |
| 2483   | ISOPROPYL ISOCYANATE   | 6.1               | 3                    | I              | 354                | 0  | E0                       | P602             | –              | –                 | –               |

| UN No. | Portable tanks and bulk containers |                     | EmS                    | Stowage and handling    | Segregation                  | Properties and observations   | UN No. |
|--------|------------------------------------|---------------------|------------------------|-------------------------|------------------------------|---|--------|
|        | Tank instructions (12)             | Provisions (14)     |                        |                         |                              |   |        |
| (12)   | (13)<br>4.2.5<br>4.3               | (14)<br>4.2.5       | (15)<br>5.4.3.4<br>7.8 | (16a)<br>7.1<br>7.3–7.7 | (16b)<br>7.2–7.7             | (17)  | (18)   |
| –      | T3                                 | TP33                | F-A, S-Q               | Category A<br>H1        | –                            | Colourless powder or granules. Mixtures with combustible material are sensitive to friction and are liable to ignite. On contact with nitrogen compounds, fumes of nitrogen trichloride can be formed, which are very explosive. Harmful by inhalation. Irritating to skin, eyes and mucous membranes.  | 2468   |
| –      | T1                                 | TP33                | F-H, S-Q               | Category A              | SGG3<br>SGG7<br>SG38<br>SG49 | Colourless powder. Soluble in water. Reacts vigorously with sulphuric acid. Reacts fiercely with cyanides when heated or by friction. May form explosive mixtures with combustible material, powdered metals or ammonium compounds. These mixtures are sensitive to friction and are liable to ignite. When involved in a fire, may cause an explosion.                       | 2469   |
| –      | T4                                 | TP1                 | F-A, S-A               | Category A              | SG35                         | Colourless to light brown liquid. Immiscible with water. Toxic if swallowed, by skin contact or by inhalation.  | 2470   |
| –      | T6                                 | TP33                | F-A, S-A               | Category B<br>SW2       | –                            | Pale yellow, crystalline, volatile solid with an irritating odour. Highly toxic if swallowed, by skin contact or by inhalation.   | 2471   |
| –      | T1                                 | TP33                | F-A, S-A               | Category A              | –                            | White, crystalline powder. Soluble in water. Toxic if swallowed, by skin contact or by dust inhalation.   | 2473   |
| –      | T20                                | TP2<br>TP13         | F-A, S-A               | Category D<br>SW2       | SG35                         | Red fuming liquid with a foul phosgene-like odour. Decomposes slowly in water. Reacts with acids, evolving toxic and corrosive fumes. Highly toxic if swallowed, by skin contact or by inhalation.  | 2474   |
| –      | T1                                 | TP33                | F-A, S-B               | Category A<br>SW2       | SGG1<br>SG36<br>SG49         | Pink, deliquescent crystals. Decomposes in water, evolving hydrogen chloride, a corrosive gas apparent as white fumes. In the presence of moisture, highly corrosive to most metals. Irritating to skin, eyes and mucous membranes.   | 2475   |
| –      | T20                                | TP2<br>TP13         | F-E, S-D               | Category D<br>SW2       | –                            | White crystals. Usually shipped as an oily liquid with a flashpoint below 60°C c.c. Melting point: 36°C (pure substance). Flashpoint: 32°C c.c. (pure substance). Insoluble in water. When involved in a fire, evolves toxic gases. Highly toxic if swallowed, by skin contact or by inhalation.  | 2477   |
| –      | T11                                | TP2<br>TP13<br>TP27 | F-E, S-D               | Category D<br>SW2       | –                            | Flammable toxic liquids with a pungent odour. Immiscible with water but react with it to form carbon dioxide. Toxic if swallowed, by skin contact or by inhalation. Irritating to skin, eyes and mucous membranes.  | 2478   |
| –      | T7                                 | TP1<br>TP13<br>TP28 | F-E, S-D               | Category A              | –                            | See entry above.  | 2478   |
| –      | T22                                | TP2<br>TP13         | F-E, S-D               | Category D<br>SW2       | SG35                         | Flammable liquid with a pungent odour. Flashpoint: –7°C c.c. (pure product). Boiling point: 38°C (pure product). Vapour heavier than air. Immiscible with water but reacts violently with it. In contact with water or acids, evolves highly toxic nitrous fumes. Highly toxic if swallowed, by skin contact or by inhalation. Irritating to skin, eyes and mucous membranes. | 2480   |
| –      | T20                                | TP2<br>TP13         | F-E, S-D               | Category D<br>SW2       | SG35                         | Liquid with a pungent odour. Flashpoint: –18°C to 0°C c.c. Boiling point: 60°C. Immiscible with water but reacts violently with it. On contact with water or acids, or when heated above boiling point, evolves highly toxic nitrous fumes. Highly toxic if swallowed, by skin contact or by inhalation. Irritating to skin, eyes and mucous membranes.                       | 2481   |
| –      | T20                                | TP2<br>TP13         | F-E, S-D               | Category D<br>SW2       | –                            | Flammable liquid with a pungent odour. Immiscible with water but reacts violently with it, evolving gases. Flashpoint: –18°C to 23°C c.c. Highly toxic if swallowed, by skin contact or by inhalation. Irritating to skin, eyes and mucous membranes.   | 2482   |
| –      | T20                                | TP2<br>TP13         | F-E, S-D               | Category D<br>SW2       | –                            | Liquid with a pungent odour. Flashpoint: –10°C to 0°C c.c. Immiscible with water but reacts violently with it, evolving gases. Highly toxic if swallowed, by skin contact or by inhalation. Irritating to skin, eyes and mucous membranes.  | 2483   |

Part 3 – Dangerous Goods List, special provisions and exceptions

Chapter 3.2 – Dangerous Goods List

| UN No. | Proper shipping name (PSN)                   | Class or division | Subsidiary hazard(s) | Packing group  | Special provisions | Limited and excepted quantity provisions |                     | Packing      |              | IBC           |               |
|--------|--|-------------------|----------------------|----------------|--------------------|--|---------------------|--------------|--------------|---------------|---------------|
|        |  |                   |                      |                |                    | Limited quantities                       | Excepted quantities | Instructions | Provisions   | Instructions  | Provisions    |
| (1)    | (2)<br>3.1.2                                 | (3)<br>2.0        | (4)<br>2.0           | (5)<br>2.0.1.3 | (6)<br>3.3         | (7a)<br>3.4                              | (7b)<br>3.5         | (8)<br>4.1.4 | (9)<br>4.1.4 | (10)<br>4.1.4 | (11)<br>4.1.4 |
| 2484   | tert-BUTYL ISOCYANATE                        | 6.1               | 3                    | I              | 354                | 0  | E0                  | P602         | -            | -             | -             |
| 2485   | n-BUTYL ISOCYANATE                           | 6.1               | 3                    | I              | 354                | 0  | E0                  | P602         | -            | -             | -             |
| 2486   | ISOBUTYL ISOCYANATE                          | 6.1               | 3                    | I              | 354                | 0  | E0                  | P602         | -            | -             | -             |
| 2487   | PHENYL ISOCYANATE                            | 6.1               | 3                    | I              | 354                | 0  | E0                  | P602         | -            | -             | -             |
| 2488   | CYCLOHEXYL ISOCYANATE                        | 6.1               | 3                    | I              | 354                | 0  | E0                  | P602         | -            | -             | -             |
| 2490   | DICHLOROISOPROPYL ETHER                      | 6.1               | -                    | II             | -                  | 100 mL                                   | E4                  | P001         | -            | IBC02         | -             |
| 2491   | ETHANOLAMINE or ETHANOLAMINE SOLUTION        | 8                 | -                    | III            | 223                | 5 L                                      | E1                  | P001 LP01    | -            | IBC03         | -             |
| 2493   | HEXAMETHYLENEIMINE                           | 3                 | 8                    | II             | -                  | 1 L                                      | E2                  | P001         | -            | IBC02         | -             |
| 2495   | IODINE PENTAFLUORIDE                         | 5.1               | 6.1/8                | I              | -                  | 0  | E0                  | P200         | -            | -             | -             |
| 2496   | PROPIONIC ANHYDRIDE                          | 8                 | -                    | III            | -                  | 5 L                                      | E1                  | P001 LP01    | -            | IBC03         | -             |
| 2498   | 1,2,3,6-TETRAHYDRO-BENZALDEHYDE              | 3                 | -                    | III            | -                  | 5 L                                      | E1                  | P001 LP01    | -            | IBC03         | -             |
| 2501   | TRIS-(1-AZIRIDINYL) PHOSPHINE OXIDE SOLUTION | 6.1               | -                    | II             | -                  | 100 mL                                   | E4                  | P001         | -            | IBC02         | -             |
| 2501   | TRIS-(1-AZIRIDINYL) PHOSPHINE OXIDE SOLUTION | 6.1               | -                    | III            | 223                | 5 L                                      | E1                  | P001 LP01    | -            | IBC03         | -             |
| 2502   | VALERYL CHLORIDE                             | 8                 | 3                    | II             | -                  | 1 L                                      | E2                  | P001         | -            | IBC02         | -             |
| 2503   | ZIRCONIUM TETRACHLORIDE                      | 8                 | -                    | III            | -                  | 5 kg                                     | E1                  | P002 LP02    | -            | IBC08         | B3            |
| 2504   | TETRABROMOETHANE                             | 6.1               | -<br>P               | III            | -                  | 5 L                                      | E1                  | P001 LP01    | -            | IBC03         | -             |

| UN No. | Portable tanks and bulk containers |               | EmS                    | Stowage and handling    | Segregation                       | Properties and observations  | UN No. |
|--------|------------------------------------|---------------|------------------------|-------------------------|-----------------------------------|--|--------|
|        | Tank instructions                  | Provisions    |                        |                         |                                   |  |        |
| (12)   | (13)<br>4.2.5<br>4.3               | (14)<br>4.2.5 | (15)<br>5.4.3.4<br>7.8 | (16a)<br>7.1<br>7.3-7.7 | (16b)<br>7.2-7.7                  | (17)   | (18)   |
| -      | T20                                | TP2 TP13      | F-E, S-D               | Category D SW2          | -                                 | Colourless liquid with a pungent odour. Immiscible with water but reacts violently with it, evolving gases. Flashpoint: 11°C c.c. Highly toxic if swallowed, by skin contact or by inhalation. Irritating to skin, eyes and mucous membranes.  | 2484   |
| -      | T20                                | TP2 TP13      | F-E, S-D               | Category D SW2          | -                                 | Colourless liquid with a pungent odour. Immiscible with water but reacts violently with it, evolving gases. Flashpoint: 19°C c.c. Highly toxic if swallowed, by skin contact or by inhalation. Irritating to skin, eyes and mucous membranes.  | 2485   |
| -      | T20                                | TP2 TP13      | F-E, S-D               | Category D SW2          | -                                 | Liquid with a pungent odour. Immiscible with water but reacts violently with it, evolving gases. Highly toxic if swallowed, by skin contact or by inhalation. Irritating to skin, eyes and mucous membranes.   | 2486   |
| -      | T20                                | TP2 TP13      | F-E, S-D               | Category D SW2          | -                                 | Colourless to yellowish liquid with a pungent odour. Flashpoint: 51°C c.c. Immiscible with water. Reacts with water, evolving carbon dioxide. Highly toxic if swallowed, by skin contact or by inhalation. Irritating to skin, eyes and mucous membranes.  | 2487   |
| -      | T20                                | TP2 TP13      | F-E, S-D               | Category D SW2          | -                                 | Yellowish liquid with an irritating odour. Flashpoint: 53°C c.c. Immiscible with water. Reacts with water, evolving carbon dioxide. Highly toxic if swallowed, by skin contact or by inhalation. Irritating to skin, eyes and mucous membranes.  | 2488   |
| -      | T7                                 | TP2           | F-A, S-A               | Category B              | -                                 | Colourless liquid. Immiscible with water. Toxic if swallowed, by skin contact or by inhalation.  | 2490   |
| -      | T4                                 | TP1           | F-A, S-B               | Category A              | SGG18 SG35                        | Colourless. Miscible with water. Corrosive to copper, copper compounds, copper alloys and rubber. Reacts violently with acids. Liquid and vapour cause burns to skin, eyes and mucous membranes.   | 2491   |
| -      | T7                                 | TP1           | F-E, S-C               | Category B SW2          | -                                 | Yellowish liquid with an ammoniacal odour. Flashpoint: 18°C c.c. Miscible with water. Harmful by inhalation. Absorbed through the skin. Causes burns to skin, eyes and mucous membranes.   | 2493   |
| -      | -                                  | -             | F-A, S-Q               | Category D SW1 SW2      | SGG1 SG6 SG16 SG19 SG35 SG36 SG49 | Colourless, fuming liquid (density 3.75). Powerful oxidant; may cause fire in contact with organic material such as wood, cotton or straw. Reacts violently with water, evolving hydrogen fluoride, a toxic, extremely corrosive gas apparent as white fumes. In contact with acids or acid fumes, evolves highly toxic fumes of iodine, fluorine and their compounds. Highly corrosive to most metals. Toxic if swallowed, by skin contact or by inhalation. Causes burns to skin, eyes and mucous membranes. | 2495   |
| -      | T4                                 | TP1           | F-A, S-B               | Category A              | SGG1 SG36 SG49                    | Colourless, combustible liquid with a pungent odour. Reacts with water, forming propionic acid. Corrosive to skin, eyes and mucous membranes.  | 2496   |
| -      | T2                                 | TP1           | F-E, S-D               | Category A              | -                                 | Colourless liquid. Flashpoint: 57°C o.c. Immiscible with water.  | 2498   |
| -      | T7                                 | TP2           | F-A, S-A               | Category A              | -                                 | Aqueous solution. Miscible with water. Toxic if swallowed, by skin contact or by inhalation.   | 2501   |
| -      | T4                                 | TP1           | F-A, S-A               | Category A              | -                                 | See entry above.   | 2501   |
| -      | T7                                 | TP2           | F-E, S-C               | Category C SW2          | SGG1 SG36 SG49                    | Liquid with a penetrating odour. Flashpoint: 23°C c.c. or above. Reacts with water, evolving hydrogen chloride, a corrosive gas apparent as white fumes. Corrosive to most metals. Causes burns to skin, eyes and mucous membranes.  | 2502   |
| -      | T1                                 | TP33          | F-A, S-B               | Category A              | SGG1 SG36 SG49                    | White, lustrous crystals. Reacts with water, evolving hydrogen chloride, a corrosive gas apparent as white fumes. In the presence of moisture, corrosive to most metals. Irritating to mucous membranes.   | 2503   |
| -      | T4                                 | TP1           | F-A, S-A               | Category A              | SGG10                             | Colourless to yellowish liquid with a camphor-like odour. Toxic if swallowed, by skin contact or by inhalation.  | 2504   |

Part 3 – Dangerous Goods List, special provisions and exceptions

Chapter 3.2 – Dangerous Goods List

| UN No. | Proper shipping name (PSN)                            | Class or division | Subsidiary hazard(s) | Packing group  | Special provisions | Limited and excepted quantity provisions |                     | Packing      |              | IBC           |               |
|--------|---|-------------------|----------------------|----------------|--------------------|--|---------------------|--------------|--------------|---------------|---------------|
|        |   |                   |                      |                |                    | Limited quantities                       | Excepted quantities | Instructions | Provisions   | Instructions  | Provisions    |
| (1)    | (2)<br>3.1.2  | (3)<br>2.0        | (4)<br>2.0           | (5)<br>2.0.1.3 | (6)<br>3.3         | (7a)<br>3.4                              | (7b)<br>3.5         | (8)<br>4.1.4 | (9)<br>4.1.4 | (10)<br>4.1.4 | (11)<br>4.1.4 |
| 2505   | AMMONIUM FLUORIDE                                     | 6.1               | –                    | III            | –                  | 5 kg                                     | E1                  | P002<br>LP02 | –            | IBC08         | B3            |
| 2506   | AMMONIUM HYDROGEN SULPHATE                            | 8                 | –                    | II             | –                  | 1 kg                                     | E2                  | P002         | –            | IBC08         | B4<br>B21     |
| 2507   | CHLOROPLATINIC ACID, SOLID                            | 8                 | –                    | III            | –                  | 5 kg                                     | E1                  | P002<br>LP02 | –            | IBC08         | B3            |
| 2508   | MOLYBDENUM PENTACHLORIDE                              | 8                 | –                    | III            | –                  | 5 kg                                     | E1                  | P002<br>LP02 | –            | IBC08         | B3            |
| 2509   | POTASSIUM HYDROGEN SULPHATE                           | 8                 | –                    | II             | –                  | 1 kg                                     | E2                  | P002         | –            | IBC08         | B4<br>B21     |
| 2511   | 2-CHLOROPROPIONIC ACID                                | 8                 | –                    | III            | 223                | 5 L                                      | E1                  | P001<br>LP01 | –            | IBC03         | –             |
| 2512   | AMINOPHENOLS ( <i>o</i> -, <i>m</i> -, <i>p</i> -)    | 6.1               | –                    | III            | 279                | 5 kg                                     | E1                  | P002<br>LP02 | –            | IBC08         | B3            |
| 2513   | BROMOACETYL BROMIDE                                   | 8                 | –                    | II             | –                  | 1 L                                      | E2                  | P001         | –            | IBC02         | B20           |
| 2514   | BROMOBENZENE  | 3                 | –<br>P               | III            | –                  | 5 L                                      | E1                  | P001<br>LP01 | –            | IBC03         | –             |
| 2515   | BROMOFORM   | 6.1               | –<br>P               | III            | –                  | 5 L                                      | E1                  | P001<br>LP01 | –            | IBC03         | –             |
| 2516   | CARBON TETRABROMIDE                                   | 6.1               | –<br>P               | III            | –                  | 5 kg                                     | E1                  | P002<br>LP02 | –            | IBC08         | B3            |
| 2517   | 1-CHLORO-1,1-DIFLUORO-ETHANE (REFRIGERANT GAS R 142b) | 2.1               | –                    | –              | –                  | 0  | E0                  | P200         | –            | –             | –             |
| 2518   | 1,5,9-CYCLODODECATRIENE                               | 6.1               | –<br>P               | III            | –                  | 5 L                                      | E1                  | P001<br>LP01 | –            | IBC03         | –             |
| 2520   | CYCLOOCTADIENES                                       | 3                 | –                    | III            | –                  | 5 L                                      | E1                  | P001<br>LP01 | –            | IBC03         | –             |
| 2521   | DIKETENE, STABILIZED                                  | 6.1               | 3                    | I              | 354<br>386         | 0  | E0                  | P602         | –            | –             | –             |
| 2522   | 2-DIMETHYLAMINOETHYL METHACRYLATE, STABILIZED         | 6.1               | –                    | II             | 386                | 100 mL                                   | E4                  | P001         | –            | IBC02         | –             |
| 2524   | ETHYL ORTHOFORMATE                                    | 3                 | –                    | III            | –                  | 5 L                                      | E1                  | P001<br>LP01 | –            | IBC03         | –             |

| UN No. | Portable tanks and bulk containers |               | EmS                    | Stowage and handling           | Segregation                  | Properties and observations   | UN No. |
|--------|------------------------------------|---------------|------------------------|--------------------------------|------------------------------|---|--------|
|        | Tank instructions                  | Provisions    |                        |                                |                              |   |        |
| (12)   | (13)<br>4.2.5<br>4.3               | (14)<br>4.2.5 | (15)<br>5.4.3.4<br>7.8 | (16a)<br>7.1<br>7.3–7.7        | (16b)<br>7.2–7.7             | (17)  | (18)   |
| –      | T1                                 | TP33          | F-A, S-A               | Category A                     | SGG2<br>SG35                 | Colourless crystals or powder with an ammonia-like odour. Readily soluble in water. Decomposes in contact with acids, evolving hydrogen fluoride, a corrosive gas. Toxic if swallowed, by skin contact or by dust inhalation.   | 2505   |
| –      | T3                                 | TP33          | F-A, S-B               | Category A<br>SW2              | SGG1<br>SGG2<br>SG36<br>SG49 | White, rhombic crystals. Soluble in water. When involved in a fire, evolves extremely irritating and corrosive fumes. In the presence of moisture, corrosive to most metals. Causes burns to skin, eyes and mucous membranes.   | 2506   |
| –      | T1                                 | TP33          | F-A, S-B               | Category A                     | SGG1<br>SG36<br>SG49         | Red-brown crystals. Soluble in water.   | 2507   |
| –      | T1                                 | TP33          | F-A, S-B               | Category C<br>SW2              | SGG1<br>SG36<br>SG49         | Black or green-black crystals. Hygroscopic. Reacts violently with water, evolving hydrogen chloride, a corrosive gas apparent as white fumes. Harmful if swallowed. Dust and vapour irritate skin, eyes and mucous membranes.   | 2508   |
| –      | T3                                 | TP33          | F-A, S-B               | Category A                     | SGG1<br>SG36<br>SG49         | Colourless crystals. Soluble in water. When involved in a fire, evolves extremely irritating and corrosive fumes. In the presence of moisture, corrosive to most metals. Irritating to skin, eyes and mucous membranes.   | 2509   |
| –      | T4                                 | TP2           | F-A, S-B               | Category A                     | SGG1<br>SG36<br>SG49         | Colourless, aqueous solution with a specific odour. Causes burns to skin, eyes and mucous membranes.  | 2511   |
| –      | T1                                 | TP33          | F-A, S-A               | Category A                     | –                            | White or brownish ( <i>ortho</i> - and <i>para</i> -) or reddish-yellow ( <i>meta</i> -) crystals. Soluble in water. Toxic if swallowed, by skin contact or by inhalation.  | 2512   |
| –      | T8                                 | TP2           | F-A, S-B               | Category C<br>SW2              | SGG1<br>SG36<br>SG49         | Clear liquid, colourless. Boiling point: 150°C. Reacts violently with water, evolving hydrogen bromide, an irritating and corrosive gas apparent as white fumes. In the presence of moisture, highly corrosive to most metals. Reacts violently with alkalis such as ammonia and hydrazine. Causes very severe burns to skin, eyes and mucous membranes. Vapour causes tears. | 2513   |
| –      | T2                                 | TP1           | F-E, S-D               | Category A                     | –                            | Colourless liquid with a characteristic odour. Flashpoint: 51°C c.c. Explosive limits: 0.5% to 2.8%. Immiscible with water.   | 2514   |
| –      | T4                                 | TP1           | F-A, S-A               | Category A<br>SW1<br>SW2<br>H2 | SGG10                        | Colourless liquid or crystals (melting point 9°C) with a chloroform-like odour. Toxic if swallowed, by skin contact or by inhalation. Narcotic effect.  | 2515   |
| –      | T1                                 | TP33          | F-A, S-A               | Category A<br>SW1              | –                            | Colourless crystals. Melting point: 48°C. Insoluble in water. Toxic if swallowed, by skin contact or by inhalation of dust and vapour.  | 2516   |
| –      | T50                                | –             | F-D, S-U               | Category B<br>SW2              | –                            | Flammable gas. Explosive limits: 8.5% to 14%. Much heavier than air (3.5).  | 2517   |
| –      | T4                                 | TP1           | F-A, S-A               | Category A<br>SW2              | –                            | Colourless liquid. Toxic if swallowed, by skin contact or by inhalation.  | 2518   |
| –      | T2                                 | TP1           | F-E, S-D               | Category A                     | –                            | Colourless liquids. Immiscible with water. 1,5-CYCLOOCTADIENE: flashpoint 38°C c.c. Irritating to skin, eyes and mucous membranes.  | 2520   |
| –      | T20                                | TP2<br>TP13   | F-E, S-D               | Category D<br>SW1<br>SW2       | SG20<br>SG21                 | Colourless flammable liquid with a pungent odour. Flashpoint: 44°C c.c. Immiscible with water, but hydrolyses slowly in contact with it. The presence of acids, bases or amines can initiate explosive polymerization. Highly toxic if swallowed, by skin contact or by inhalation.   | 2521   |
| –      | T7                                 | TP2           | F-A, S-A               | Category D<br>SW2              | –                            | Combustible liquid. Causes tears. Toxic if swallowed, by skin contact or by inhalation.   | 2522   |
| –      | T2                                 | TP1           | F-E, S-D               | Category A                     | –                            | Colourless liquid with an ethereal odour. Flashpoint: 30°C c.c. Immiscible with water.  | 2524   |



Part 3 – Dangerous Goods List, special provisions and exceptions

Chapter 3.2 – Dangerous Goods List

| UN No. | Proper shipping name (PSN)              | Class or division | Subsidiary hazard(s) | Packing group  | Special provisions | Limited and excepted quantity provisions |                     | Packing      |              | IBC           |               |
|--------|---|-------------------|----------------------|----------------|--------------------|--|---------------------|--------------|--------------|---------------|---------------|
|        |   |                   |                      |                |                    | Limited quantities                       | Excepted quantities | Instructions | Provisions   | Instructions  | Provisions    |
| (1)    | (2)<br>3.1.2                            | (3)<br>2.0        | (4)<br>2.0           | (5)<br>2.0.1.3 | (6)<br>3.3         | (7a)<br>3.4                              | (7b)<br>3.5         | (8)<br>4.1.4 | (9)<br>4.1.4 | (10)<br>4.1.4 | (11)<br>4.1.4 |
| 2525   | ETHYL OXALATE                           | 6.1               | –                    | III            | –                  | 5 L                                      | E1                  | P001<br>LP01 | –            | IBC03         | –             |
| 2526   | FURFURYLAMINE                           | 3                 | 8                    | III            | –                  | 5 L                                      | E1                  | P001         | –            | IBC03         | –             |
| 2527   | ISOBUTYL ACRYLATE, STABILIZED           | 3                 | –                    | III            | 386                | 5 L                                      | E1                  | P001<br>LP01 | –            | IBC03         | –             |
| 2528   | ISOBUTYL ISOBUTYRATE                    | 3                 | –                    | III            | –                  | 5 L                                      | E1                  | P001<br>LP01 | –            | IBC03         | –             |
| 2529   | ISOBUTYRIC ACID                         | 3                 | 8                    | III            | –                  | 5 L                                      | E1                  | P001         | –            | IBC03         | –             |
| 2531   | METHACRYLIC ACID, STABILIZED            | 8                 | –                    | II             | 386                | 1 L                                      | E2                  | P001         | –            | IBC02         | –             |
| 2533   | METHYL TRICHLOROACETATE                 | 6.1               | –                    | III            | –                  | 5 L                                      | E1                  | P001<br>LP01 | –            | IBC03         | –             |
| 2534   | METHYLCHLOROSILANE                      | 2.3               | 2.1/8                | –              | –                  | 0  | E0                  | P200         | –            | –             | –             |
| 2535   | 4-METHYLMORPHOLINE (N-METHYLMORPHOLINE) | 3                 | 8                    | II             | –                  | 1 L                                      | E2                  | P001         | –            | IBC02         | –             |
| 2536   | METHYLTETRAHYDROFURAN                   | 3                 | –                    | II             | –                  | 1 L                                      | E2                  | P001         | –            | IBC02         | –             |
| 2538   | NITRONAPHTHALENE                        | 4.1               | –                    | III            | –                  | 5 kg                                     | E1                  | P002<br>LP02 | –            | IBC08         | B3            |
| 2541   | TERPINOLENE                             | 3                 | –                    | III            | –                  | 5 L                                      | E1                  | P001<br>LP01 | –            | IBC03         | –             |
| 2542   | TRIBUTYLAMINE                           | 6.1               | –                    | II             | –                  | 100 mL                                   | E4                  | P001         | –            | IBC02         | –             |
| 2545   | HAFNIUM POWDER, DRY                     | 4.2               | –                    | I              | –                  | 0  | E0                  | P404         | PP31         | –             | –             |
| 2545   | HAFNIUM POWDER, DRY                     | 4.2               | –                    | II             | –                  | 0  | E2                  | P410         | PP31         | IBC06         | B21           |
| 2545   | HAFNIUM POWDER, DRY                     | 4.2               | –                    | III            | 223                | 0  | E1                  | P002<br>LP02 | PP31<br>L4   | IBC08         | B4            |
| 2546   | TITANIUM POWDER, DRY                    | 4.2               | –                    | I              | –                  | 0  | E0                  | P404         | PP31         | –             | –             |
| 2546   | TITANIUM POWDER, DRY                    | 4.2               | –                    | II             | –                  | 0  | E2                  | P410         | PP31         | IBC06         | B21           |
| 2546   | TITANIUM POWDER, DRY                    | 4.2               | –                    | III            | 223                | 0  | E1                  | P002<br>LP02 | PP31<br>L4   | IBC08         | B4            |

| UN No. | Portable tanks and bulk containers |                     | EmS                    | Stowage and handling     | Segregation           | Properties and observations  | UN No. |
|--------|------------------------------------|---------------------|------------------------|--------------------------|-----------------------|--|--------|
|        | Tank instructions                  | Provisions          |                        |                          |                       |  |        |
| (12)   | (13)<br>4.2.5<br>4.3               | (14)<br>4.2.5       | (15)<br>5.4.3.4<br>7.8 | (16a)<br>7.1<br>7.3–7.7  | (16b)<br>7.2–7.7      | (17)   | (18)   |
| –      | T4                                 | TP1                 | F-A, S-A               | Category A               | –                     | Colourless, oily, aromatic liquid. Slowly decomposed by water. Toxic if swallowed, by skin contact or by dust inhalation.  | 2525   |
| –      | T4                                 | TP1                 | F-E, S-C               | Category A<br>SW2        | SG35                  | Pale yellow, oily liquid. Flashpoint: 37°C o.c. Miscible with water. Harmful by inhalation. Causes burns to skin and eyes. Irritating to mucous membranes.   | 2526   |
| –      | T2                                 | TP1                 | F-E, S-D               | Category C<br>SW1        | –                     | Colourless liquid with a pungent odour. Flashpoint: 29°C o.c. Immiscible with water. Harmful by inhalation. Irritating to skin, eyes and mucous membranes.   | 2527   |
| –      | T2                                 | TP1                 | F-E, S-D               | Category A               | –                     | Colourless liquid with a fruity odour. Flashpoint: 37°C c.c. Explosive limits: 0.96% to 7.59%. Immiscible with water.  | 2528   |
| –      | T4                                 | TP1                 | F-E, S-C               | Category A               | –                     | Colourless liquid with a pungent odour. Flashpoint: 55°C c.c. Explosive limits: 2% to 9.2%. Miscible with water. Causes burns to skin and eyes. Irritating to skin, eyes and mucous membranes.   | 2529   |
| –      | T7                                 | TP2<br>TP18<br>TP30 | F-A, S-B               | Category C<br>SW1<br>SW2 | SGG1<br>SG36<br>SG49  | Colourless, combustible liquid with a specific odour. Miscible with water. Polymerizes readily above its melting point (15°C), thereby generating heat and possible risk of explosion; should therefore be properly stabilized. Cooling below melting point (15°C) followed by subsequent reheating can release uninhibited monomer that readily polymerizes. Decomposes when heated, evolving toxic gases. Causes burns to skin, eyes and mucous membranes. | 2531   |
| –      | T4                                 | TP1                 | F-A, S-A               | Category A               | –                     | Colourless liquid. Immiscible with water. Toxic if swallowed, by skin contact or by inhalation.  | 2533   |
| –      | –                                  | –                   | F-D, S-U               | Category D<br>SW2        | SG4<br>SG9            | Liquefied, flammable, toxic and corrosive colourless gas with a pungent odour. Reacts with water, evolving hydrogen chloride, an irritating and corrosive gas. Heavier than air. Boiling point: 9°C. Highly irritating to skin, eyes and mucous membranes.   | 2534   |
| –      | T7                                 | TP1                 | F-E, S-C               | Category B<br>SW2        | –                     | Colourless liquid with an ammonia-like odour. Flashpoint: 13°C c.c. Miscible with water. Harmful by inhalation. Causes burns to skin and eyes. Irritating to mucous membranes.   | 2535   |
| –      | T4                                 | TP1                 | F-E, S-D               | Category B               | –                     | Colourless, volatile liquid with an ether-like odour. Flashpoint: –11°C o.c. Immiscible with water.  | 2536   |
| –      | T1                                 | TP33                | F-A, S-G               | Category A               | –                     | Yellow crystals. Insoluble in water. Harmful if swallowed.   | 2538   |
| –      | T2                                 | TP1                 | F-E, S-E               | Category A               | –                     | Colourless to pale amber liquid with a lemon odour. Flashpoint: 37°C c.c. Immiscible with water.   | 2541   |
| –      | T7                                 | TP2                 | F-A, S-A               | Category A               | –                     | Colourless, combustible liquid with an amine odour. Immiscible with water. When involved in a fire, evolves toxic gases. Toxic if swallowed, by skin contact or by inhalation.   | 2542   |
| –      | –                                  | –                   | F-G, S-M               | Category D<br>H1         | SGG15<br>SG26         | Black amorphous powder. Insoluble in water. Liable to ignite spontaneously in air. Forms explosive mixtures with oxidizing substances.   | 2545   |
| –      | T3                                 | TP33                | F-G, S-M               | Category D<br>H1         | SGG15<br>SG26         | See entry above.   | 2545   |
| –      | T1                                 | TP33                | F-G, S-M               | Category D<br>H1         | SGG15<br>SG26         | See entry above.   | 2545   |
| –      | –                                  | –                   | F-G, S-M               | Category D<br>H1         | SGG7<br>SGG15<br>SG26 | Grey powder. Liable to ignite spontaneously in air. Forms explosive mixtures with oxidizing substances.  | 2546   |
| –      | T3                                 | TP33                | F-G, S-M               | Category D<br>H1         | SGG7<br>SGG15<br>SG26 | See entry above.   | 2546   |
| –      | T1                                 | TP33                | F-G, S-M               | Category D<br>H1         | SGG7<br>SGG15<br>SG26 | See entry above.   | 2546   |

Part 3 – Dangerous Goods List, special provisions and exceptions

Chapter 3.2 – Dangerous Goods List

| UN No. | Proper shipping name (PSN)  | Class or division | Subsidiary hazard(s) | Packing group  | Special provisions | Limited and excepted quantity provisions |                     | Packing      |              | IBC           |               |
|--------|---|-------------------|----------------------|----------------|--------------------|--|---------------------|--------------|--------------|---------------|---------------|
|        |   |                   |                      |                |                    | Limited quantities                       | Excepted quantities | Instructions | Provisions   | Instructions  | Provisions    |
| (1)    | (2)<br>3.1.2  | (3)<br>2.0        | (4)<br>2.0           | (5)<br>2.0.1.3 | (6)<br>3.3         | (7a)<br>3.4                              | (7b)<br>3.5         | (8)<br>4.1.4 | (9)<br>4.1.4 | (10)<br>4.1.4 | (11)<br>4.1.4 |
| 2547   | SODIUM SUPEROXIDE   | 5.1               | –                    | I              | –                  | 0  | E0                  | P503         | –            | IBC06         | B1            |
| 2548   | CHLORINE PENTAFLUORIDE  | 2.3               | 5.1/8                | –              | –                  | 0  | E0                  | P200         | –            | –             | –             |
| 2552   | HEXAFLUOROACETONE HYDRATE, LIQUID   | 6.1               | –                    | II             | –                  | 100 mL                                   | E4                  | P001         | –            | IBC02         | –             |
| 2554   | METHYLALLYL CHLORIDE  | 3                 | –                    | II             | –                  | 1 L                                      | E2                  | P001         | –            | IBC02         | –             |
| 2555   | NITROCELLULOSE WITH WATER (not less than 25% water, by mass)  | 4.1               | –                    | II             | 28<br>394          | 0  | E0                  | P406         | PP31         | –             | –             |
| 2556   | NITROCELLULOSE WITH ALCOHOL (not less than 25% alcohol, by mass, and not more than 12.6% nitrogen, by dry mass)             | 4.1               | –                    | II             | 28<br>394          | 0  | E0                  | P406         | PP31         | –             | –             |
| 2557   | NITROCELLULOSE with not more than 12.6% nitrogen, by dry mass, MIXTURE WITH or WITHOUT PLASTICIZER, WITH or WITHOUT PIGMENT | 4.1               | –                    | II             | 241<br>394         | 0  | E0                  | P406         | PP31         | –             | –             |
| 2558   | EPIBROMOHYDRIN  | 6.1               | 3<br>P               | I              | –                  | 0  | E0                  | P001         | –            | –             | –             |
| 2560   | 2-METHYLPENTAN-2-OL   | 3                 | –                    | III            | –                  | 5 L                                      | E1                  | P001<br>LP01 | –            | IBC03         | –             |
| 2561   | 3-METHYL-1-BUTENE   | 3                 | –                    | I              | –                  | 0  | E3                  | P001         | –            | –             | –             |
| 2564   | TRICHLOROACETIC ACID SOLUTION   | 8                 | –                    | II             | –                  | 1 L                                      | E2                  | P001         | –            | IBC02         | –             |
| 2564   | TRICHLOROACETIC ACID SOLUTION   | 8                 | –                    | III            | 223                | 5 L                                      | E1                  | P001<br>LP01 | –            | IBC03         | –             |
| 2565   | DICYCLOHEXYLAMINE   | 8                 | –                    | III            | –                  | 5 L                                      | E1                  | P001<br>LP01 | –            | IBC03         | –             |
| 2567   | SODIUM PENTACHLOROPHENATE   | 6.1               | –<br>P               | II             | –                  | 500 g                                    | E4                  | P002         | –            | IBC08         | B4<br>B21     |

| UN No. | Portable tanks and bulk containers |               | EmS                    | Stowage and handling    | Segregation                           | Properties and observations  | UN No. |
|--------|------------------------------------|---------------|------------------------|-------------------------|---------------------------------------|--|--------|
|        | Tank instructions                  | Provisions    |                        |                         |                                       |  |        |
| (12)   | (13)<br>4.2.5<br>4.3               | (14)<br>4.2.5 | (15)<br>5.4.3.4<br>7.8 | (16a)<br>7.1<br>7.3–7.7 | (16b)<br>7.2–7.7                      | (17)   | (18)   |
| –      | –                                  | –             | F-G, S-Q               | Category D<br>H1        | SGG16<br>SG16<br>SG26<br>SG35<br>SG59 | Pale yellow coarse powder or granules. Particularly if wetted with small quantities of water, a mixture with combustible material may ignite, following impact or friction. When involved in a fire, or in contact with water or acids, decomposes, evolving oxygen. Highly irritating to skin, eyes and mucous membranes.   | 2547   |
| –      | –                                  | –             | F-C, S-W               | Category D<br>SW2       | SG6<br>SG19                           | Non-flammable, toxic and corrosive gas. Forms dense, white, corrosive fumes in moist air. Reacts violently with water, evolving hydrogen fluoride, a toxic, irritating and corrosive gas apparent as white fumes. Corrosive to glass and to most metals. Powerful oxidizing agent which may cause violent fires with combustible materials. Much heavier than air (4.5). Highly irritating to skin, eyes and mucous membranes.                                       | 2548   |
| –      | T7                                 | TP2           | F-A, S-A               | Category B<br>SW2       | –                                     | Toxic if swallowed, by skin contact or by inhalation.  | 2552   |
| –      | T4                                 | TP1<br>TP13   | F-E, S-D               | Category E              | SGG10                                 | Colourless to yellowish, volatile liquid with a penetrating odour. Flashpoint: –12°C c.c. Explosive limits: 2.3% to 9.3%. Immiscible with water. When involved in a fire, may evolve highly toxic phosgene gas. Harmful by inhalation. Irritating to skin, eyes and mucous membranes.  | 2554   |
| –      | –                                  | –             | F-B, S-J               | Category E              | SG7<br>SG30                           | Desensitized explosive. Nitrocellulose may be granular or in flakes, blocks or fibrous form. When involved in a fire, evolves toxic fumes; in closed compartments, these fumes may form an explosive mixture with air. May form extremely sensitive compounds with heavy metals or their salts.  | 2555   |
| –      | –                                  | –             | F-B, S-J               | Category D<br>SW1<br>H2 | SG7<br>SG30                           | Nitrocellulose may be granular or in flakes, blocks or fibrous form. In case of leakage, flammable vapours are evolved which, in closed compartments, may form explosive mixtures with air. When involved in a fire, evolves toxic fumes; in closed compartments, these fumes may form an explosive mixture with air. Highly explosive when dry. May form extremely sensitive compounds with heavy metals or their salts.  | 2556   |
| –      | –                                  | –             | F-B, S-J               | Category D              | SG7<br>SG30                           | Nitrocellulose may be in granular form or in flakes. This product may also contain added pigments. When involved in a fire, evolves toxic fumes; in closed compartments, these fumes may form an explosive mixture with air. Burns extremely rapidly with intense heat radiation. The formulation should be prepared so that it remains homogeneous and does not separate during transport. May form extremely sensitive compounds with heavy metals or their salts. | 2557   |
| –      | T14                                | TP2<br>TP13   | F-E, S-D               | Category D<br>SW2       | –                                     | Flammable liquid. Flashpoint: 56°C c.c. Highly toxic if swallowed, by skin contact or by inhalation.   | 2558   |
| –      | T2                                 | TP1           | F-E, S-D               | Category A              | –                                     | Colourless liquid. Flashpoint: 30°C c.c. Partially miscible with water. Irritating to skin, eyes and mucous membranes.   | 2560   |
| –      | T11                                | TP2           | F-E, S-D               | Category E              | –                                     | Colourless, volatile liquid with a disagreeable odour. Flashpoint: below –18°C c.c. Immiscible with water. Irritating to skin, eyes and mucous membranes.  | 2561   |
| –      | T7                                 | TP2           | F-A, S-B               | Category B              | SGG1<br>SG36<br>SG49                  | Colourless, clear solution with a pungent odour. Corrosive to most metals. Causes burns to skin, eyes and mucous membranes.  | 2564   |
| –      | T4                                 | TP1           | F-A, S-B               | Category B              | SGG1<br>SG36<br>SG49                  | See entry above.   | 2564   |
| –      | T4                                 | TP1           | F-A, S-B               | Category A              | SG35                                  | Clear, colourless, combustible liquid with a fishy odour which may taint other cargoes. Immiscible with water. Causes burns to skin, eyes and mucous membranes.  | 2565   |
| –      | T3                                 | TP33          | F-A, S-A               | Category A              | –                                     | White or light brown powder with a pungent odour. Soluble in water. Toxic if swallowed, by skin contact or by dust inhalation.   | 2567   |

Part 3 – Dangerous Goods List, special provisions and exceptions

Chapter 3.2 – Dangerous Goods List

| UN No. | Proper shipping name (PSN)  | Class or division | Subsidiary hazard(s) | Packing group  | Special provisions | Limited and excepted quantity provisions |                     | Packing      |              | IBC           |               |
|--------|---|-------------------|----------------------|----------------|--------------------|--|---------------------|--------------|--------------|---------------|---------------|
|        |   |                   |                      |                |                    | Limited quantities                       | Excepted quantities | Instructions | Provisions   | Instructions  | Provisions    |
| (1)    | (2)<br>3.1.2  | (3)<br>2.0        | (4)<br>2.0           | (5)<br>2.0.1.3 | (6)<br>3.3         | (7a)<br>3.4                              | (7b)<br>3.5         | (8)<br>4.1.4 | (9)<br>4.1.4 | (10)<br>4.1.4 | (11)<br>4.1.4 |
| 2570   | CADMIUM COMPOUND  | 6.1               | –                    | I              | 274                | 0  | E5                  | P002         | –            | IBC07         | B1            |
| 2570   | CADMIUM COMPOUND  | 6.1               | –                    | II             | 274                | 500 g                                    | E4                  | P002         | –            | IBC08         | B4<br>B21     |
| 2570   | CADMIUM COMPOUND  | 6.1               | –                    | III            | 223<br>274         | 5 kg                                     | E1                  | P002<br>LP02 | –            | IBC08         | B3            |
| 2571   | ALKYLSULPHURIC ACIDS  | 8                 | –                    | II             | –                  | 1 L                                      | E2                  | P001         | –            | IBC02         | –             |
| 2572   | PHENYLHYDRAZINE   | 6.1               | –                    | II             | –                  | 100 mL                                   | E4                  | P001         | –            | IBC02         | –             |
| 2573   | THALLIUM CHLORATE   | 5.1               | 6.1<br>P             | II             | –                  | 1 kg                                     | E2                  | P002         | –            | IBC06         | B21           |
| 2574   | TRICRESYL PHOSPHATE with more than 3% <i>ortho</i> -isomer                                      | 6.1               | –<br>P               | II             | –                  | 100 mL                                   | E4                  | P001         | –            | IBC02         | –             |
| 2576   | PHOSPHORUS OXYBROMIDE, MOLTEN   | 8                 | –                    | II             | –                  | 0  | E0                  | –            | –            | –             | –             |
| 2577   | PHENYLACETYL CHLORIDE   | 8                 | –                    | II             | –                  | 1 L                                      | E2                  | P001         | –            | IBC02         | –             |
| 2578   | PHOSPHORUS TRIOXIDE   | 8                 | –                    | III            | –                  | 5 kg                                     | E1                  | P002<br>LP02 | –            | IBC08         | B3            |
| 2579   | PIPERAZINE  | 8                 | –                    | III            | –                  | 5 kg                                     | E1                  | P002<br>LP02 | –            | IBC08         | B3            |
| 2580   | ALUMINIUM BROMIDE SOLUTION  | 8                 | –                    | III            | 223                | 5 L                                      | E1                  | P001<br>LP01 | –            | IBC03         | –             |
| 2581   | ALUMINIUM CHLORIDE SOLUTION   | 8                 | –                    | III            | 223                | 5 L                                      | E1                  | P001<br>LP01 | –            | IBC03         | –             |
| 2582   | FERRIC CHLORIDE SOLUTION  | 8                 | –                    | III            | 223                | 5 L                                      | E1                  | P001<br>LP01 | –            | IBC03         | –             |
| 2583   | ALKYLSULPHONIC ACIDS, SOLID or ARYLSULPHONIC ACIDS, SOLID with more than 5% free sulphuric acid | 8                 | –                    | II             | –                  | 1 kg                                     | E2                  | P002         | –            | IBC08         | B4<br>B21     |

| UN No. | Portable tanks and bulk containers |                     | EmS                    | Stowage and handling    | Segregation          | Properties and observations  | UN No. |
|--------|------------------------------------|---------------------|------------------------|-------------------------|----------------------|--|--------|
|        | Tank instructions                  | Provisions          |                        |                         |                      |  |        |
| (12)   | (13)<br>4.2.5<br>4.3               | (14)<br>4.2.5       | (15)<br>5.4.3.4<br>7.8 | (16a)<br>7.1<br>7.3–7.7 | (16b)<br>7.2–7.7     | (17)   | (18)   |
| –      | T6                                 | TP33                | F-A, S-A               | Category A              | –                    | Powder or crystals with various colours. May be soluble or insoluble in water. Toxic if swallowed, by skin contact or by dust inhalation.  | 2570   |
| –      | T3                                 | TP33                | F-A, S-A               | Category A              | –                    | See entry above.   | 2570   |
| –      | T1                                 | TP33                | F-A, S-A               | Category A              | –                    | See entry above.   | 2570   |
| –      | T8                                 | TP2<br>TP13<br>TP28 | F-A, S-B               | Category C<br>SW15      | SGG1<br>SG36<br>SG49 | Colourless oily liquids. React with water, evolving heat. Cause burns to skin, eyes and mucous membranes. Highly corrosive to metal.   | 2571   |
| –      | T7                                 | TP2                 | F-A, S-A               | Category A<br>SW2       | –                    | Pale yellow oily liquid. Melting point: 20°C. Slightly soluble in water. Toxic if swallowed, by skin contact or by inhalation.   | 2572   |
| –      | T3                                 | TP33                | F-H, S-Q               | Category A              | SGG4<br>SG38<br>SG49 | Colourless crystals. Slightly soluble in water. Reacts vigorously with sulphuric acid. Reacts fiercely with cyanides when heated or by friction. May form explosive mixtures with combustible material, powdered metals or ammonium compounds. These mixtures are sensitive to friction and are liable to ignite. When involved in a fire, may cause an explosion. Toxic if swallowed, by skin contact or by dust inhalation.  | 2573   |
| –      | T7                                 | TP2                 | F-A, S-A               | Category A              | –                    | Colourless liquid. A mixture of isomers. Immiscible with water. Toxic if swallowed, by skin contact or by inhalation.  | 2574   |
| –      | T7                                 | TP3<br>TP13         | F-A, S-B               | Category C<br>SW2       | SGG1<br>SG36<br>SG49 | Colourless liquid with a pungent odour. Melting point: 56°C. Reacts violently with water, evolving hydrogen bromide, a toxic and corrosive gas apparent as white fumes. Reacts violently with organic materials (such as wood, cotton, straw), causing fire. When involved in a fire, evolves highly toxic and corrosive gases. In the presence of moisture, highly corrosive to most metals. Vapours and liquid cause burns to skin, eyes and mucous membranes. Shipped molten above its melting point. | 2576   |
| –      | T7                                 | TP2                 | F-A, S-B               | Category C<br>SW2       | SGG1<br>SG36<br>SG49 | Colourless liquid with a pungent odour. Reacts with water, evolving hydrogen chloride, an irritating and corrosive gas apparent as white fumes. When involved in a fire, evolves highly toxic fumes. Corrosive to most metals. Vapour irritates eyes and mucous membranes. Liquid is corrosive to skin, eyes and mucous membranes.   | 2577   |
| –      | T1                                 | TP33                | F-A, S-B               | Category A<br>SW1<br>H2 | SGG1<br>SG36<br>SG49 | Colourless crystals or white deliquescent powder. Melting point: 23°C. Reacts with water, evolving heat and at normal temperatures phosphoric acid, but at higher temperatures phosphine, a highly toxic gas. In the presence of moisture, corrosive to most metals. Causes burns to skin, eyes and mucous membranes.  | 2578   |
| –      | T1                                 | TP33                | F-A, S-B               | Category A<br>SW1<br>H2 | SGG18<br>SG35        | Colourless, deliquescent crystals, turning dark on exposure to light. Soluble in water. Decomposes when heated and when involved in a fire, evolving highly toxic nitrous fumes. The solution in water is a strong base and is highly corrosive. Reacts violently with acids. Irritating to skin, eyes and mucous membranes.   | 2579   |
| –      | T4                                 | TP1                 | F-A, S-B               | Category A              | SGG1<br>SG36<br>SG49 | Colourless to yellowish liquid. Highly corrosive to most metals. Vapour highly irritating to skin, eyes and mucous membranes. Liquid causes severe burns to skin, eyes and mucous membranes.   | 2580   |
| –      | T4                                 | TP1                 | F-A, S-B               | Category A              | SGG1<br>SG36<br>SG49 | Colourless to yellowish liquid. Highly corrosive to most metals. Vapour highly irritating to skin, eyes and mucous membranes. Liquid causes severe burns to skin, eyes and mucous membranes.   | 2581   |
| –      | T4                                 | TP1                 | F-A, S-B               | Category A              | SGG1<br>SG36<br>SG49 | Colourless to light brown liquid. Highly corrosive to most metals.   | 2582   |
| –      | T3                                 | TP33                | F-A, S-B               | Category A              | SGG1<br>SG36<br>SG49 | When involved in a fire, evolve highly toxic gases. Corrosive to most metals, especially in the presence of moisture. Cause burns to skin, eyes and mucous membranes.  | 2583   |



Part 3 – Dangerous Goods List, special provisions and exceptions

Chapter 3.2 – Dangerous Goods List

| UN No. | Proper shipping name (PSN)  | Class or division | Subsidiary hazard(s) | Packing group  | Special provisions | Limited and excepted quantity provisions |                     | Packing      |              | IBC           |               |
|--------|---|-------------------|----------------------|----------------|--------------------|--|---------------------|--------------|--------------|---------------|---------------|
|        |   |                   |                      |                |                    | Limited quantities                       | Excepted quantities | Instructions | Provisions   | Instructions  | Provisions    |
| (1)    | (2)<br>3.1.2  | (3)<br>2.0        | (4)<br>2.0           | (5)<br>2.0.1.3 | (6)<br>3.3         | (7a)<br>3.4                              | (7b)<br>3.5         | (8)<br>4.1.4 | (9)<br>4.1.4 | (10)<br>4.1.4 | (11)<br>4.1.4 |
| 2584   | ALKYLSULPHONIC ACIDS, LIQUID or ARYLSULPHONIC ACIDS, LIQUID with more than 5% free sulphuric acid                                     | 8                 | –                    | II             | –                  | 1 L                                      | E2                  | P001         | –            | IBC02         | B20           |
| 2585   | ALKYLSULPHONIC ACIDS, SOLID or ARYLSULPHONIC ACIDS, SOLID with not more than 5% free sulphuric acid                                   | 8                 | –                    | III            | –                  | 5 kg                                     | E1                  | P002 LP02    | –            | IBC08         | B3            |
| 2586   | ALKYLSULPHONIC ACIDS, LIQUID or ARYLSULPHONIC ACIDS, LIQUID with not more than 5% free sulphuric acid                                 | 8                 | –                    | III            | –                  | 5 L                                      | E1                  | P001 LP01    | –            | IBC03         | –             |
| 2587   | BENZOQUINONE  | 6.1               | –                    | II             | –                  | 500 g                                    | E4                  | P002         | –            | IBC08         | B4 B21        |
| 2588   | PESTICIDE, SOLID, TOXIC, N.O.S.   | 6.1               | –                    | I              | 61 274             | 0  | E5                  | P002         | –            | IBC99         | –             |
| 2588   | PESTICIDE, SOLID, TOXIC, N.O.S.   | 6.1               | –                    | II             | 61 274             | 500 g                                    | E4                  | P002         | –            | IBC08         | B4 B21        |
| 2588   | PESTICIDE, SOLID, TOXIC, N.O.S.   | 6.1               | –                    | III            | 61 223 274         | 5 kg                                     | E1                  | P002 LP02    | –            | IBC08         | B3            |
| 2589   | VINYL CHLOROACETATE   | 6.1               | 3                    | II             | –                  | 100 mL                                   | E4                  | P001         | –            | IBC02         | –             |
| 2590   | ASBESTOS, CHRYSOTILE  | 9                 | –                    | III            | 168                | 5 kg                                     | E1                  | P002         | PP37         | IBC08         | B3 B21        |
| 2591   | XENON, REFRIGERATED LIQUID  | 2.2               | –                    | –              | –                  | 120 mL                                   | E1                  | P203         | –            | –             | –             |
| 2599   | CHLOROTRIFLUOROMETHANE AND TRIFLUOROMETHANE AZEOTROPIC MIXTURE with approximately 60% chlorotrifluoromethane (REFRIGERANT GAS R 503)  | 2.2               | –                    | –              | –                  | 120 mL                                   | E1                  | P200         | –            | –             | –             |
| 2601   | CYCLOBUTANE   | 2.1               | –                    | –              | –                  | 0  | E0                  | P200         | –            | –             | –             |
| 2602   | DICHLORODIFLUORO-METHANE AND DIFLUOROETHANE AZEOTROPIC MIXTURE with approximately 74% dichlorodifluoromethane (REFRIGERANT GAS R 500) | 2.2               | –                    | –              | –                  | 120 mL                                   | E1                  | P200         | –            | –             | –             |

| UN No. | Portable tanks and bulk containers |               | EmS                    | Stowage and handling    | Segregation      | Properties and observations  | UN No. |
|--------|------------------------------------|---------------|------------------------|-------------------------|------------------|--|--------|
|        | Tank instructions                  | Provisions    |                        |                         |                  |  |        |
| (12)   | (13)<br>4.2.5<br>4.3               | (14)<br>4.2.5 | (15)<br>5.4.3.4<br>7.8 | (16a)<br>7.1<br>7.3–7.7 | (16b)<br>7.2–7.7 | (17)   | (18)   |
| –      | T8                                 | TP2 TP13      | F-A, S-B               | Category B              | SGG1 SG36 SG49   | Liquids usually with a pungent odour. When involved in a fire, evolve highly toxic gases. Highly corrosive to most metals. Cause burns to skin, eyes and mucous membranes.   | 2584   |
| –      | T1                                 | TP33          | F-A, S-B               | Category A              | SGG1 SG36 SG49   | Crystalline solids. When involved in a fire, evolve highly toxic gases. In the presence of moisture, corrosive to most metals. Cause burns to skin, eyes and mucous membranes.   | 2585   |
| –      | T4                                 | TP1           | F-A, S-B               | Category B              | SGG1 SG36 SG49   | Liquids usually with a pungent odour. When involved in a fire, evolve highly toxic gases. Corrosive to most metals. Cause burns to skin, eyes and mucous membranes.  | 2586   |
| –      | T3                                 | TP33          | F-A, S-A               | Category A              | –                | Yellow crystals with an irritating and penetrating odour resembling that of chlorine. Slightly soluble in water. Toxic if swallowed, by skin contact or by dust inhalation.  | 2587   |
| –      | T6                                 | TP33          | F-A, S-A               | Category A SW2          | –                | Solid pesticides present a very wide range of toxic hazard. Toxic if swallowed, by skin contact or by inhalation.  | 2588   |
| –      | T3                                 | TP33          | F-A, S-A               | Category A SW2          | –                | See entry above.   | 2588   |
| –      | T1                                 | TP33          | F-A, S-A               | Category A SW2          | –                | See entry above.   | 2588   |
| –      | T7                                 | TP2           | F-E, S-D               | Category A              | –                | Flammable liquid. Flashpoint: 50°C c.c. Immiscible with water. Toxic if swallowed, by skin contact or by inhalation.   | 2589   |
| –      | T1                                 | TP33          | F-A, S-A               | Category A SW2 H4       | SG29             | Mineral fibres of varying length. Non-combustible. Inhalation of the dust of asbestos fibres is dangerous and therefore exposure should be avoided at all times. Always prevent the generation of asbestos dust. A safe level of airborne concentration of asbestos fibres may be obtained through effective packing. Cargo spaces or freight containers that have contained any type of raw asbestos should be carefully cleaned before discharging any remaining cargo, loading other cargo or carrying out repair or maintenance work. Whenever possible, cleaning of cargo spaces should be carried out whilst the ship is in a port where proper facilities and equipment, including proper respiratory apparatus and protective clothing, are available. Parts of the body that may have been exposed should be immediately and thoroughly washed. All waste material should be collected in impermeable and sealed bags for safe disposal ashore. If cleaning cannot be carried out at the discharge port, arrangements should be made in advance for cleaning to be carried out at the next port where necessary facilities are available. | 2590   |
| –      | T75                                | TP5           | F-C, S-V               | Category D              | –                | Liquefied, inert, colourless and odourless gas. Much heavier than air (4.5).   | 2591   |
| –      | –                                  | –             | F-C, S-V               | Category A              | –                | Non-flammable, colourless gas with a mild ethereal odour. Much heavier than air (3.2).   | 2599   |
| –      | –                                  | –             | F-D, S-U               | Category B SW2          | –                | Liquefied, flammable, colourless gas. Explosive limits: 1.8% to 10%. Heavier than air (1.9). Boiling point: 13°C.  | 2601   |
| –      | T50                                | –             | F-C, S-V               | Category A              | –                | Non-flammable, colourless and odourless gas. Much heavier than air (3.7).  | 2602   |

Part 3 – Dangerous Goods List, special provisions and exceptions

Chapter 3.2 – Dangerous Goods List

| UN No. | Proper shipping name (PSN)         | Class or division | Subsidiary hazard(s) | Packing group  | Special provisions | Limited and excepted quantity provisions |                     | Packing      |              | IBC           |               |
|--------|------------------------------------|-------------------|----------------------|----------------|--------------------|--|---------------------|--------------|--------------|---------------|---------------|
|        |                                    |                   |                      |                |                    | Limited quantities                       | Excepted quantities | Instructions | Provisions   | Instructions  | Provisions    |
| (1)    | (2)<br>3.1.2                       | (3)<br>2.0        | (4)<br>2.0           | (5)<br>2.0.1.3 | (6)<br>3.3         | (7a)<br>3.4                              | (7b)<br>3.5         | (8)<br>4.1.4 | (9)<br>4.1.4 | (10)<br>4.1.4 | (11)<br>4.1.4 |
| 2603   | CYCLOHEPTATRIENE                   | 3                 | 6.1                  | II             | –                  | 1 L                                      | E2                  | P001         | –            | IBC02         | –             |
| 2604   | BORON TRIFLUORIDE DIETHYL ETHERATE | 8                 | 3                    | I              | –                  | 0  | E0                  | P001         | PP31         | –             | –             |
| 2605   | METHOXYMETHYL ISOCYANATE           | 6.1               | 3                    | I              | 354                | 0  | E0                  | P602         | –            | –             | –             |
| 2606   | METHYL ORTHOSILICATE               | 6.1               | 3                    | I              | 354                | 0  | E0                  | P602         | –            | –             | –             |
| 2607   | ACROLEIN DIMER, STABILIZED         | 3                 | –                    | III            | 386                | 5 L                                      | E1                  | P001<br>LP01 | –            | IBC03         | –             |
| 2608   | NITROPROPANES                      | 3                 | –                    | III            | –                  | 5 L                                      | E1                  | P001<br>LP01 | –            | IBC03         | –             |
| 2609   | TRIALLYL BORATE                    | 6.1               | –                    | III            | –                  | 5 L                                      | E1                  | P001<br>LP01 | –            | IBC03         | –             |
| 2610   | TRIALLYLAMINE                      | 3                 | 8                    | III            | –                  | 5 L                                      | E1                  | P001         | –            | IBC03         | –             |
| 2611   | PROPYLENE CHLOROHYDRIN             | 6.1               | 3                    | II             | –                  | 100 mL                                   | E4                  | P001         | –            | IBC02         | –             |
| 2612   | METHYL PROPYL ETHER                | 3                 | –                    | II             | –                  | 1 L                                      | E2                  | P001         | –            | IBC02         | B8            |
| 2614   | METHALLYL ALCOHOL                  | 3                 | –                    | III            | –                  | 5 L                                      | E1                  | P001<br>LP01 | –            | IBC03         | –             |
| 2615   | ETHYL PROPYL ETHER                 | 3                 | –                    | II             | –                  | 1 L                                      | E2                  | P001         | –            | IBC02         | –             |
| 2616   | TRIISOPROPYL BORATE                | 3                 | –                    | II             | –                  | 1 L                                      | E2                  | P001         | –            | IBC02         | –             |
| 2616   | TRIISOPROPYL BORATE                | 3                 | –                    | III            | 223                | 5 L                                      | E1                  | P001<br>LP01 | –            | IBC03         | –             |
| 2617   | METHYLCYCLOHEXANOLS, flammable     | 3                 | –                    | III            | –                  | 5 L                                      | E1                  | P001<br>LP01 | –            | IBC03         | –             |
| 2618   | VINYLTOLUENES, STABILIZED          | 3                 | –                    | III            | 386                | 5 L                                      | E1                  | P001<br>LP01 | –            | IBC03         | –             |
| 2619   | BENZYLDIMETHYLAMINE                | 8                 | 3                    | II             | –                  | 1 L                                      | E2                  | P001         | –            | IBC02         | –             |

| UN No. | Portable tanks and bulk containers |               | EmS                    | Stowage and handling           | Segregation          | Properties and observations  | UN No. |
|--------|------------------------------------|---------------|------------------------|--------------------------------|----------------------|--|--------|
|        | Tank instructions                  | Provisions    |                        |                                |                      |  |        |
| (12)   | (13)<br>4.2.5<br>4.3               | (14)<br>4.2.5 | (15)<br>5.4.3.4<br>7.8 | (16a)<br>7.1<br>7.3–7.7        | (16b)<br>7.2–7.7     | (17)   | (18)   |
| –      | T7                                 | TP1<br>TP13   | F-E, S-D               | Category E<br>SW2              | –                    | Colourless to dark yellow liquid with a characteristic odour. Flashpoint: 0°C to 4°C c.c. Immiscible with water. Reacts vigorously with oxidizing substances. Toxic if swallowed, by skin contact or by inhalation.  | 2603   |
| –      | T10                                | TP2           | F-E, S-C               | Category D<br>SW2              | SGG1<br>SG36<br>SG49 | Colourless fuming flammable liquid. Flashpoint: 59°C c.c. The flashpoint will be lower when free ether is present. Reacts vigorously with oxidizing substances. Decomposes in contact with water, evolving toxic, corrosive and flammable vapours. Causes burns to skin, eyes and mucous membranes. Inhalation of small quantities of vapour can cause breathing difficulties. | 2604   |
| –      | T20                                | TP2<br>TP13   | F-E, S-D               | Category D<br>SW2              | –                    | Colourless liquid with a pungent odour. Flashpoint: 13°C c.c. Immiscible with water. Highly toxic if swallowed, by skin contact or by inhalation. Irritating to skin, eyes and mucous membranes.   | 2605   |
| –      | T20                                | TP2<br>TP13   | F-E, S-D               | Category D<br>SW2              | –                    | Colourless, flammable liquid with an ethereal odour. Immiscible with water. Flashpoint: –18°C to 19°C c.c. Highly toxic if swallowed, by skin contact or by inhalation. May cause blindness.   | 2606   |
| –      | T2                                 | TP1           | F-E, S-D               | Category C<br>SW1<br>SW2       | –                    | Colourless liquid with a pungent odour. Flashpoint: 48°C o.c. Miscible with water. Harmful by inhalation. Irritating to skin, eyes and mucous membranes.   | 2607   |
| –      | T2                                 | TP1           | F-E, S-D               | Category A                     | –                    | Colourless liquids. Explosive limits: 2.2% to 11%. 1-NITROPROPANE: flashpoint approx. 33°C c.c. 2-NITROPROPANE: flashpoint approx. 28°C c.c. Partially miscible with water. Harmful by inhalation.   | 2608   |
| –      | –                                  | –             | F-A, S-A               | Category A<br>H1               | –                    | Liquid. Hydrolyses in contact with water, forming allyl alcohol. Toxic if swallowed, by skin contact or by inhalation.   | 2609   |
| –      | T4                                 | TP1           | F-E, S-C               | Category A<br>SW2              | SG35                 | Colourless liquid with a fishy odour. Flashpoint: 39°C o.c. Corrosive when in contact with water. Harmful by inhalation. Causes burns to skin and eyes. Irritating to mucous membranes.  | 2610   |
| –      | T7                                 | TP2<br>TP13   | F-E, S-D               | Category A<br>SW1<br>SW2<br>H2 | –                    | Colourless flammable liquid with a mild odour. Flashpoint: 51°C c.c. Miscible with water. Decomposes when heated, evolving highly toxic fumes. Toxic if swallowed, by skin contact or by inhalation.   | 2611   |
| –      | T7                                 | TP2           | F-E, S-D               | Category E<br>SW2              | –                    | Colourless, volatile liquid with an ethereal odour. Flashpoint: below –18°C c.c. Lower explosive limit: 2%. Boiling point: 39°C. Partially miscible with water. Narcotic. Irritating to skin, eyes and mucous membranes.   | 2612   |
| –      | T2                                 | TP1           | F-E, S-D               | Category A                     | –                    | Colourless liquid with a pungent odour. Flashpoint: 34°C c.c. Miscible with water. Irritating to skin, eyes and mucous membranes.  | 2614   |
| –      | T4                                 | TP1           | F-E, S-D               | Category E                     | –                    | Colourless, volatile liquids. Flashpoint: below –18°C c.c. Explosive limits: 1.7% to 9.0%. Miscible with water. Irritating to skin, eyes and mucous membranes.   | 2615   |
| –      | T4                                 | TP1           | F-E, S-D               | Category B                     | –                    | Colourless liquid. Flashpoint: 17°C to 60°C c.c. Reacts with water, evolving flammable vapours.  | 2616   |
| –      | T2                                 | TP1           | F-E, S-D               | Category A                     | –                    | See entry above.   | 2616   |
| –      | T2                                 | TP1           | F-E, S-D               | Category A                     | –                    | Colourless, viscous liquid with a menthol-like odour. Flashpoint: 58°C c.c. Partially miscible with water.   | 2617   |
| –      | T2                                 | TP1           | F-E, S-D               | Category C<br>SW1              | –                    | Colourless liquids. Flashpoint: 54°C to 60°C c.c. Explosive limits: 0.9% to 6.1%. Partially miscible with water. Harmful by inhalation. Irritating to skin, eyes and mucous membranes.   | 2618   |
| –      | T7                                 | TP2           | F-E, S-C               | Category A<br>SW1<br>SW2       | SG35                 | Colourless, flammable liquid with an aromatic odour. Flashpoint: 58°C c.c. Immiscible with water. Harmful if swallowed, by skin contact or by inhalation. Corrosive to skin, eyes and mucous membranes.  | 2619   |

Part 3 – Dangerous Goods List, special provisions and exceptions

Chapter 3.2 – Dangerous Goods List

| UN No. | Proper shipping name (PSN)   | Class or division | Subsidiary hazard(s) | Packing group  | Special provisions | Limited and excepted quantity provisions |                     | Packing      |              | IBC           |               |
|--------|--|-------------------|----------------------|----------------|--------------------|--|---------------------|--------------|--------------|---------------|---------------|
|        |  |                   |                      |                |                    | Limited quantities                       | Excepted quantities | Instructions | Provisions   | Instructions  | Provisions    |
| (1)    | (2)<br>3.1.2   | (3)<br>2.0        | (4)<br>2.0           | (5)<br>2.0.1.3 | (6)<br>3.3         | (7a)<br>3.4                              | (7b)<br>3.5         | (8)<br>4.1.4 | (9)<br>4.1.4 | (10)<br>4.1.4 | (11)<br>4.1.4 |
| 2620   | AMYL BUTYRATES   | 3                 | –                    | III            | –                  | 5 L                                      | E1                  | P001<br>LP01 | –            | IBC03         | –             |
| 2621   | ACETYL METHYL CARBINOL   | 3                 | –                    | III            | –                  | 5 L                                      | E1                  | P001<br>LP01 | –            | IBC03         | –             |
| 2622   | GLYCIDALDEHYDE   | 3                 | 6.1                  | II             | –                  | 1 L                                      | E2                  | P001         | –            | IBC02         | B8            |
| 2623   | FIRELIGHTERS, SOLID with flammable liquid                          | 4.1               | –                    | III            | –                  | 5 kg                                     | E1                  | P002<br>LP02 | PP15         | –             | –             |
| 2624   | MAGNESIUM SILICIDE   | 4.3               | –                    | II             | –                  | 500 g                                    | E2                  | P410         | PP31<br>PP40 | IBC07         | B4<br>B21     |
| 2626   | CHLORIC ACID, AQUEOUS SOLUTION with not more than 10% chloric acid | 5.1               | –                    | II             | 900                | 1 L                                      | E0                  | P504         | PP31         | IBC02         | –             |
| 2627   | NITRITES, INORGANIC, N.O.S.  | 5.1               | –                    | II             | 274<br>900         | 1 kg                                     | E2                  | P002         | –            | IBC08         | B4<br>B21     |
| 2628   | POTASSIUM FLUOROACETATE  | 6.1               | –                    | I              | –                  | 0  | E5                  | P002         | –            | IBC07         | B1            |
| 2629   | SODIUM FLUOROACETATE   | 6.1               | –                    | I              | –                  | 0  | E5                  | P002         | –            | IBC07         | B1            |
| 2630   | SELENATES or SELENITES   | 6.1               | –                    | I              | 274                | 0  | E5                  | P002         | –            | IBC07         | B1            |
| 2642   | FLUOROACETIC ACID  | 6.1               | –                    | I              | –                  | 0  | E5                  | P002         | –            | IBC07         | B1            |
| 2643   | METHYL BROMOACETATE  | 6.1               | –                    | II             | –                  | 100 mL                                   | E4                  | P001         | –            | IBC02         | –             |
| 2644   | METHYL IODIDE  | 6.1               | –                    | I              | 354                | 0  | E0                  | P602         | –            | –             | –             |
| 2645   | PHENACYL BROMIDE   | 6.1               | –                    | II             | –                  | 500 g                                    | E4                  | P002         | –            | IBC08         | B4<br>B21     |
| 2646   | HEXACHLOROCYCLO-PENTADIENE   | 6.1               | –                    | I              | 354                | 0  | E0                  | P602         | –            | –             | –             |
| 2647   | MALONONITRILE  | 6.1               | –                    | II             | –                  | 500 g                                    | E4                  | P002         | –            | IBC08         | B4<br>B21     |
| 2648   | 1,2-DIBROMOBUTAN-3-ONE   | 6.1               | –                    | II             | –                  | 100 mL                                   | E4                  | P001         | –            | IBC02         | –             |
| 2649   | 1,3-DICHLOROACETONE  | 6.1               | –                    | II             | –                  | 500 g                                    | E4                  | P002         | –            | IBC08         | B4<br>B21     |

| UN No. | Portable tanks and bulk containers |               | EmS                    | Stowage and handling           | Segregation                   | Properties and observations  | UN No. |
|--------|------------------------------------|---------------|------------------------|--------------------------------|-------------------------------|--|--------|
|        | Tank instructions                  | Provisions    |                        |                                |                               |  |        |
| (12)   | (13)<br>4.2.5<br>4.3               | (14)<br>4.2.5 | (15)<br>5.4.3.4<br>7.8 | (16a)<br>7.1<br>7.3–7.7        | (16b)<br>7.2–7.7              | (17)   | (18)   |
| –      | T2                                 | TP1           | F-E, S-D               | Category A                     | –                             | Colourless liquids. Flashpoint: 52°C to 58°C c.c. Partially miscible with water.   | 2620   |
| –      | T2                                 | TP1           | F-E, S-D               | Category A                     | –                             | Yellow liquid with a pleasant odour. Flashpoint: 44°C to 52°C c.c. Miscible with water. Reacts vigorously with oxidizing substances. Irritating to skin, eyes and mucous membranes.  | 2621   |
| –      | T7                                 | TP1           | F-E, S-D               | Category A<br>SW2              | –                             | Colourless liquid with a pungent odour. Flashpoint: 31°C o.c. Miscible with water. Toxic by inhalation. Irritating to skin, eyes and mucous membranes.   | 2622   |
| –      | –                                  | –             | F-A, S-I               | Category A                     | SG35                          | A porous solid, e.g. cellular urea-formaldehyde resin, compacted wood shavings, etc., impregnated with flammable liquid, usually white spirit or kerosene, and designed to burn in a controlled manner. When heated, evolves flammable vapours.  | 2623   |
| –      | T3                                 | TP33          | F-G, S-O               | Category B<br>SW5<br>H1        | SG26                          | White powder or crystals. Reacts with water or steam, evolving hydrogen, a flammable gas. In contact with acids, evolves silane, a spontaneously flammable gas.  | 2624   |
| –      | –                                  | –             | F-A, S-Q               | Category D                     | SGG1<br>SG36<br>SG38<br>SG49  | Colourless liquid. May decompose, evolving chlorine and oxygen with toxic, corrosive and oxidizing effects. May form explosive mixtures with ammonium compounds, combustible material or powdered metals. Corrosive to most metals. Transport of CHLORIC ACID, AQUEOUS SOLUTION with more than 10% chloric acid is prohibited.                       | 2626   |
| –      | T3                                 | TP33          | F-A, S-Q               | Category A                     | SGG12<br>SG38<br>SG49<br>SG62 | Solids. Solid mixtures with combustible material are readily ignited and may burn fiercely. Solid mixtures with ammonium compounds or cyanides may explode. If heated, may decompose, giving off toxic nitrous fumes. Harmful if swallowed. Transport of AMMONIUM NITRITES and mixtures of an inorganic nitrite with an ammonium salt is prohibited. | 2627   |
| –      | T6                                 | TP33          | F-A, S-A               | Category E                     | –                             | Solid. Soluble in water. Highly toxic if swallowed, by skin contact or by dust inhalation.   | 2628   |
| –      | T6                                 | TP33          | F-A, S-A               | Category E                     | –                             | White powder. Soluble in water. Highly toxic if swallowed, by skin contact or by dust inhalation.  | 2629   |
| –      | T6                                 | TP33          | F-A, S-A               | Category E                     | –                             | A wide range of toxic solids. Generally soluble in water. Highly toxic if swallowed, by skin contact or by dust inhalation.  | 2630   |
| –      | T6                                 | TP33          | F-A, S-A               | Category E                     | SGG1<br>SG36<br>SG49          | Colourless crystals. Melting point: 33°C. Soluble in water. Highly toxic if swallowed, by skin contact or by dust inhalation.  | 2642   |
| –      | T7                                 | TP2           | F-A, S-A               | Category D<br>SW2              | –                             | Colourless to straw-coloured liquid. Slightly miscible with water. Causes tears. Toxic if swallowed, by skin contact or by inhalation.   | 2643   |
| –      | T20                                | TP2<br>TP13   | F-A, S-A               | Category D<br>SW1<br>SW2<br>H2 | SGG10                         | Colourless liquid. Boiling point: 42°C to 43°C. Slightly miscible with water. When heated, evolves toxic fumes. Highly toxic if swallowed, by skin contact or by inhalation. Has strong narcotic effects.  | 2644   |
| –      | T3                                 | TP33          | F-A, S-A               | Category B<br>SW2              | –                             | White crystals changing to a greenish colour under the influence of light. Melting point: 50°C. Insoluble in water. Causes tears. Toxic if swallowed, by skin contact or by inhalation.  | 2645   |
| –      | T20                                | TP2<br>TP13   | F-A, S-A               | Category D<br>SW2              | SGG10                         | Pale yellow liquid with a pungent odour. Immiscible with water. Causes tears. Highly toxic if swallowed, by skin contact or by inhalation.   | 2646   |
| –      | T3                                 | TP33          | F-A, S-A               | Category A<br>SW1<br>H2        | –                             | Colourless crystals. Melting point: 32°C. Soluble in water. When heated, evolves highly toxic cyanogen fumes. Toxic if swallowed, by skin contact or by dust inhalation.   | 2647   |
| –      | –                                  | –             | F-A, S-A               | Category B<br>SW2              | –                             | Liquid. Immiscible with water. Toxic if swallowed, by skin contact or by inhalation. Causes tears.   | 2648   |
| –      | T3                                 | TP33          | F-A, S-A               | Category B<br>SW1<br>SW2<br>H2 | –                             | Crystals. Melting point: 45°C. Soluble in water. Decomposes when heated, evolving highly toxic fumes. Toxic if swallowed, by skin contact or by dust inhalation. Causes tears.   | 2649   |

Part 3 – Dangerous Goods List, special provisions and exceptions

Chapter 3.2 – Dangerous Goods List

| UN No. | Proper shipping name (PSN)  | Class or division | Subsidiary hazard(s) | Packing group  | Special provisions | Limited and excepted quantity provisions |                     | Packing      |              | IBC           |               |
|--------|---|-------------------|----------------------|----------------|--------------------|--|---------------------|--------------|--------------|---------------|---------------|
|        |   |                   |                      |                |                    | Limited quantities                       | Excepted quantities | Instructions | Provisions   | Instructions  | Provisions    |
| (1)    | (2)<br>3.1.2  | (3)<br>2.0        | (4)<br>2.0           | (5)<br>2.0.1.3 | (6)<br>3.3         | (7a)<br>3.4                              | (7b)<br>3.5         | (8)<br>4.1.4 | (9)<br>4.1.4 | (10)<br>4.1.4 | (11)<br>4.1.4 |
| 2650   | 1,1-DICHLORO-1-NITRO-ETHANE   | 6.1               | -                    | II             | -                  | 100 mL                                   | E4                  | P001         | -            | IBC02         | -             |
| 2651   | 4,4'-DIAMINODIPHENYL-METHANE  | 6.1               | -<br>P               | III            | -                  | 5 kg                                     | E1                  | P002<br>LP02 | -            | IBC08         | B3            |
| 2653   | BENZYL IODIDE   | 6.1               | -                    | II             | -                  | 100 mL                                   | E4                  | P001         | -            | IBC02         | -             |
| 2655   | POTASSIUM FLUOROSILICATE  | 6.1               | -                    | III            | -                  | 5 kg                                     | E1                  | P002<br>LP02 | -            | IBC08         | B3            |
| 2656   | QUINOLINE   | 6.1               | -                    | III            | -                  | 5 L                                      | E1                  | P001<br>LP01 | -            | IBC03         | -             |
| 2657   | SELENIUM DISULPHIDE   | 6.1               | -                    | II             | -                  | 500 g                                    | E4                  | P002         | -            | IBC08         | B4<br>B21     |
| 2659   | SODIUM CHLOROACETATE  | 6.1               | -                    | III            | -                  | 5 kg                                     | E1                  | P002<br>LP02 | -            | IBC08         | B3            |
| 2660   | NITROTOLUIDINES (MONO)  | 6.1               | -                    | III            | -                  | 5 kg                                     | E1                  | P002<br>LP02 | -            | IBC08         | B3            |
| 2661   | HEXACHLOROACETONE   | 6.1               | -                    | III            | -                  | 5 L                                      | E1                  | P001<br>LP01 | -            | IBC03         | -             |
| 2664   | DIBROMOMETHANE  | 6.1               | -                    | III            | -                  | 5 L                                      | E1                  | P001<br>LP01 | -            | IBC03         | -             |
| 2667   | BUTYLTOLUENES   | 6.1               | -                    | III            | -                  | 5 L                                      | E1                  | P001<br>LP01 | -            | IBC03         | -             |
| 2668   | CHLOROACETONITRILE  | 6.1               | 3                    | I              | 354                | 0  | E0                  | P602         | -            | -             | -             |
| 2669   | CHLOROCRESOLS SOLUTION  | 6.1               | -                    | II             | -                  | 100 mL                                   | E4                  | P001         | -            | IBC02         | -             |
| 2669   | CHLOROCRESOLS SOLUTION  | 6.1               | -                    | III            | 223                | 5 L                                      | E1                  | P001<br>LP01 | -            | IBC03         | -             |
| 2670   | CYANURIC CHLORIDE   | 8                 | -                    | II             | -                  | 1 kg                                     | E2                  | P002         | -            | IBC08         | B4<br>B21     |
| 2671   | AMINOPYRIDINES (o-, m-, p-)   | 6.1               | -                    | II             | -                  | 500 g                                    | E4                  | P002         | -            | IBC08         | B4<br>B21     |
| 2672   | AMMONIA SOLUTION, relative density between 0.880 and 0.957 at 15°C in water, with more than 10% but not more than 35% ammonia | 8                 | -<br>P               | III            | -                  | 5 L                                      | E1                  | P001<br>LP01 | -            | IBC03         | B11           |

| UN No. | Portable tanks and bulk containers |               | EmS                    | Stowage and handling           | Segregation          | Properties and observations   | UN No. |
|--------|------------------------------------|---------------|------------------------|--------------------------------|----------------------|---|--------|
|        | Tank instructions                  | Provisions    |                        |                                |                      |   |        |
| (12)   | (13)<br>4.2.5<br>4.3               | (14)<br>4.2.5 | (15)<br>5.4.3.4<br>7.8 | (16a)<br>7.1<br>7.3-7.7        | (16b)<br>7.2-7.7     | (17)  | (18)   |
| -      | T7                                 | TP2           | F-A, S-A               | Category A<br>SW1<br>SW2<br>H2 | SG17                 | Liquid. Immiscible with water. May react vigorously with oxidizing substances. Decomposes when heated, evolving highly toxic fumes (oxides of nitrogen). Toxic if swallowed, by skin contact or by inhalation.  | 2650   |
| -      | T1                                 | TP33          | F-A, S-A               | Category A                     | -                    | Tan-coloured flakes or lumps. Slightly soluble in water. Decomposes when heated, evolving highly toxic fumes. Toxic if swallowed, by skin contact or by dust inhalation. May be carried in the molten state.  | 2651   |
| -      | T7                                 | TP2           | F-A, S-A               | Category B<br>SW1<br>SW2<br>H2 | -                    | Colourless crystals. Melting point: 24°C. Insoluble in water. Toxic if swallowed, by skin contact or by dust inhalation. Causes tears.  | 2653   |
| -      | T1                                 | TP33          | F-A, S-A               | Category A                     | SG35                 | Solids which react with acids, evolving hydrogen fluoride and silicon tetrafluoride, irritating and corrosive gases. Toxic if swallowed, by skin contact or by dust inhalation.   | 2655   |
| -      | T4                                 | TP1           | F-A, S-A               | Category A<br>SW1<br>H2        | -                    | Colourless liquid with a pungent odour. Immiscible with water. When heated, evolves highly toxic fumes (of oxides of nitrogen). Toxic if swallowed, by skin contact or by inhalation.   | 2656   |
| -      | T3                                 | TP33          | F-A, S-A               | Category A                     | -                    | Bright red-yellow crystals with a faint odour. Insoluble in water. Toxic if swallowed, by skin contact or by inhalation.  | 2657   |
| -      | T1                                 | TP33          | F-A, S-A               | Category A                     | -                    | White powder. Soluble in water. Toxic if swallowed, by skin contact or by dust inhalation.  | 2659   |
| -      | T1                                 | TP33          | F-A, S-A               | Category A                     | -                    | Yellow to orange-red crystalline solids. Insoluble in water. Toxic if swallowed, by skin contact or by dust inhalation.   | 2660   |
| -      | T4                                 | TP1           | F-A, S-A               | Category B<br>SW1<br>SW2<br>H2 | -                    | Colourless to yellowish liquid. Slightly miscible with water. When heated, evolves extremely toxic fumes (phosgene). Causes tears. Toxic if swallowed, by skin contact or by inhalation.  | 2661   |
| -      | T4                                 | TP1           | F-A, S-A               | Category A                     | SGG10                | Clear, colourless liquid. Immiscible with water. Toxic if swallowed, by skin contact or by inhalation.  | 2664   |
| -      | T4                                 | TP1           | F-A, S-A               | Category A                     | -                    | Colourless liquids. Immiscible with water. Toxic if swallowed, by skin contact or by inhalation.  | 2667   |
| -      | T20                                | TP2<br>TP13   | F-A, S-A               | Category D<br>SW1<br>SW2<br>H2 | SG35                 | Colourless flammable liquid with a pungent odour. Flashpoint: 56°C c.c. Immiscible with water. Decomposes when heated, evolving highly toxic fumes of cyanides. Reacts with steam and acids, evolving toxic and flammable vapours. Highly toxic if swallowed, by skin contact or by inhalation. | 2668   |
| -      | T7                                 | TP2           | F-A, S-A               | Category A<br>SW1<br>H2        | -                    | Solutions with a phenol-like odour. Slightly miscible with water. Decompose when heated, evolving extremely toxic fumes (phosgene). Toxic if swallowed, by skin contact or by inhalation.   | 2669   |
| -      | T7                                 | TP2           | F-A, S-A               | Category A<br>SW1<br>H2        | -                    | See entry above.  | 2669   |
| -      | T3                                 | TP33          | F-A, S-B               | Category A<br>SW1<br>SW2<br>H2 | SGG1<br>SG36<br>SG49 | Colourless crystals with a pungent odour. Reacts with water, forming toxic and corrosive acids. Decomposes when heated, evolving toxic and corrosive gases. Causes burns to skin, eyes and mucous membranes.  | 2670   |
| -      | T3                                 | TP33          | F-A, S-A               | Category B<br>SW1<br>SW2<br>H2 | SGG18<br>SG35        | White powder or crystals. Melting points: 58°C to 64°C. Soluble in water. Reacts violently with acids. Toxic if swallowed, by skin contact or by dust inhalation.   | 2671   |
| -      | T7                                 | TP2           | F-A, S-B               | Category A<br>SW2<br>SW5       | SGG18<br>SG35        | Colourless liquid with a pungent odour. Corrosive to copper, nickel, zinc and tin and their alloys such as brass. Not significantly corrosive to iron and steel. Reacts violently with acids. Liquid and vapour cause burns to skin, eyes and mucous membranes.                                 | 2672   |



Part 3 – Dangerous Goods List, special provisions and exceptions

Chapter 3.2 – Dangerous Goods List

| UN No. | Proper shipping name (PSN)   | Class or division | Subsidiary hazard(s) | Packing group  | Special provisions | Limited and excepted quantity provisions |                          | Packing          |                | IBC               |                 |
|--------|------------------------------|-------------------|----------------------|----------------|--------------------|--|--------------------------|------------------|----------------|-------------------|-----------------|
|        |                              |                   |                      |                |                    | Limited quantities (7a)                  | Excepted quantities (7b) | Instructions (8) | Provisions (9) | Instructions (10) | Provisions (11) |
| (1)    | (2)<br>3.1.2                 | (3)<br>2.0        | (4)<br>2.0           | (5)<br>2.0.1.3 | (6)<br>3.3         | (7a)<br>3.4                              | (7b)<br>3.5              | (8)<br>4.1.4     | (9)<br>4.1.4   | (10)<br>4.1.4     | (11)<br>4.1.4   |
| 2673   | 2-AMINO-4-CHLOROPHENOL       | 6.1               | –                    | II             | –                  | 500 g                                    | E4                       | P002             | –              | IBC08             | B4<br>B21       |
| 2674   | SODIUM FLUOROSILICATE        | 6.1               | –                    | III            | –                  | 5 kg                                     | E1                       | P002<br>LP02     | –              | IBC08             | B3              |
| 2676   | STIBINE                      | 2.3               | 2.1                  | –              | –                  | 0  | E0                       | P200             | –              | –                 | –               |
| 2677   | RUBIDIUM HYDROXIDE SOLUTION  | 8                 | –                    | II             | –                  | 1 L                                      | E2                       | P001             | –              | IBC02             | –               |
| 2677   | RUBIDIUM HYDROXIDE SOLUTION  | 8                 | –                    | III            | 223                | 5 L                                      | E1                       | P001<br>LP01     | –              | IBC03             | –               |
| 2678   | RUBIDIUM HYDROXIDE           | 8                 | –                    | II             | –                  | 1 kg                                     | E2                       | P002             | –              | IBC08             | B4<br>B21       |
| 2679   | LITHIUM HYDROXIDE SOLUTION   | 8                 | –                    | II             | –                  | 1 L                                      | E2                       | P001             | –              | IBC02             | –               |
| 2679   | LITHIUM HYDROXIDE SOLUTION   | 8                 | –                    | III            | 223                | 5 L                                      | E1                       | P001<br>LP01     | –              | IBC03             | –               |
| 2680   | LITHIUM HYDROXIDE            | 8                 | –                    | II             | –                  | 1 kg                                     | E2                       | P002             | –              | IBC08             | B4<br>B21       |
| 2681   | CAESIUM HYDROXIDE SOLUTION   | 8                 | –                    | II             | –                  | 1 L                                      | E2                       | P001             | –              | IBC02             | –               |
| 2681   | CAESIUM HYDROXIDE SOLUTION   | 8                 | –                    | III            | 223                | 5 L                                      | E1                       | P001<br>LP01     | –              | IBC03             | –               |
| 2682   | CAESIUM HYDROXIDE            | 8                 | –                    | II             | –                  | 1 kg                                     | E2                       | P002             | –              | IBC08             | B4<br>B21       |
| 2683   | AMMONIUM SULPHIDE SOLUTION   | 8                 | 3/6.1                | II             | –                  | 1 L                                      | E2                       | P001             | –              | IBC01             | –               |
| 2684   | 3-DIETHYLAMINO-PROPYLAMINE   | 3                 | 8                    | III            | –                  | 5 L                                      | E1                       | P001             | –              | IBC03             | –               |
| 2685   | N,N-DIETHYLETHYLENE-DIAMINE  | 8                 | 3                    | II             | –                  | 1 L                                      | E2                       | P001             | –              | IBC02             | –               |
| 2686   | 2-DIETHYLAMINOETHANOL        | 8                 | 3                    | II             | –                  | 1 L                                      | E2                       | P001             | –              | IBC02             | –               |
| 2687   | DICYCLOHEXYLAMMONIUM NITRITE | 4.1               | –                    | III            | –                  | 5 kg                                     | E1                       | P002<br>LP02     | –              | IBC08             | B3              |
| 2688   | 1-BROMO-3-CHLOROPROPANE      | 6.1               | –                    | III            | –                  | 5 L                                      | E1                       | P001<br>LP01     | –              | IBC03             | –               |

| UN No. | Portable tanks and bulk containers |                 | EmS                    | Stowage and handling    | Segregation                   | Properties and observations   | UN No. |
|--------|------------------------------------|-----------------|------------------------|-------------------------|-------------------------------|---|--------|
|        | Tank instructions (12)             | Provisions (14) |                        |                         |                               |   |        |
| (12)   | (13)<br>4.2.5<br>4.3               | (14)<br>4.2.5   | (15)<br>5.4.3.4<br>7.8 | (16a)<br>7.1<br>7.3–7.7 | (16b)<br>7.2–7.7              | (17)  | (18)   |
| –      | T3                                 | TP33            | F-A, S-A               | Category A              | –                             | Light brown crystals. Slightly soluble in water. Toxic if swallowed, by skin contact or by dust inhalation.   | 2673   |
| –      | T1                                 | TP33            | F-A, S-A               | Category A              | SG35                          | Solids which react with acids, evolving hydrogen fluoride and silicon tetrafluoride, irritating and corrosive gases. Toxic if swallowed, by skin contact or by dust inhalation.   | 2674   |
| –      | –                                  | –               | F-D, S-U               | Category D<br>SW2       | –                             | Flammable, toxic, colourless gas with a foul odour. Decomposes violently in the presence of water. Much heavier than air (4.3).   | 2676   |
| –      | T7                                 | TP2             | F-A, S-B               | Category A              | SGG18<br>SG22<br>SG35         | Liquid. Reacts violently with acids. Reacts with ammonium salts, evolving ammonia gas. Corrosive to aluminium, zinc and tin. Causes burns to skin, eyes and mucous membranes.   | 2677   |
| –      | T4                                 | TP1             | F-A, S-B               | Category A              | SGG18<br>SG22<br>SG35         | See entry above.  | 2677   |
| –      | T3                                 | TP33            | F-A, S-B               | Category A              | SGG18<br>SG22<br>SG35         | Greyish-white solid, very hygroscopic. Reacts violently with acids. Reacts with ammonium salts, evolving ammonia gas. In the presence of moisture, corrosive to aluminium, zinc and tin. Causes burns to skin, eyes and mucous membranes.   | 2678   |
| –      | T7                                 | TP2             | F-A, S-B               | Category A              | SGG18<br>SG22<br>SG35         | Colourless liquid. Corrosive to aluminium, zinc and tin. Causes burns to skin, eyes and mucous membranes.   | 2679   |
| –      | T4                                 | TP2             | F-A, S-B               | Category A              | SGG18<br>SG22<br>SG35         | See entry above.  | 2679   |
| –      | T3                                 | TP33            | F-A, S-B               | Category A              | SGG18<br>SG35                 | Colourless crystals. Soluble in water. Reacts violently with acids. Causes burns to skin, eyes and mucous membranes.  | 2680   |
| –      | T7                                 | TP2             | F-A, S-B               | Category A              | SGG18<br>SG22<br>SG35         | Colourless liquid. Reacts violently with acids. Reacts with ammonium salts, evolving ammonia gas. Corrosive to glass, aluminium, zinc and tin. Causes burns to skin, eyes and mucous membranes.   | 2681   |
| –      | T4                                 | TP1             | F-A, S-B               | Category A              | SGG18<br>SG22<br>SG35         | See entry above.  | 2681   |
| –      | T3                                 | TP33            | F-A, S-B               | Category A              | SGG18<br>SG22<br>SG35         | Colourless or yellowish hygroscopic crystals. Reacts violently with acids. Reacts with ammonium salts, evolving ammonia gas. In the presence of moisture, corrosive to glass, aluminium, zinc and tin. Causes burns to skin, eyes and mucous membranes.                                     | 2682   |
| –      | T7                                 | TP2<br>TP13     | F-E, S-C               | Category B<br>SW1<br>H2 | SGG2<br>SGG18<br>SG35<br>SG68 | Yellow liquid with a foul odour (of rotten eggs). When heated, evolves toxic and flammable vapours. Reacts violently with acids, evolving hydrogen sulphide, a toxic and flammable gas. Toxic if swallowed, by skin contact or by inhalation. Corrosive to skin, eyes and mucous membranes. | 2683   |
| –      | T4                                 | TP1             | F-E, S-C               | Category A              | SG35                          | Colourless liquid with a fishy odour. Flashpoint: 59°C o.c. Miscible with water. Irritating to skin, eyes and mucous membranes.   | 2684   |
| –      | T7                                 | TP2             | F-E, S-C               | Category A              | SG35                          | Colourless, flammable liquid with a fishy odour. Flashpoint: 46°C o.c. Miscible with water. Harmful by skin contact. Irritating to eyes and mucous membranes.   | 2685   |
| –      | T7                                 | TP2             | F-E, S-C               | Category A              | SG35                          | Colourless liquid. Miscible with water. Reacts violently with oxidizing substances. Explosive limits: 1.8% to 28%. Flashpoint: 46°C to 60°C c.c. Causes burns to skin, eyes and mucous membranes.   | 2686   |
| –      | T1                                 | TP33            | F-A, S-G               | Category A              | SGG2                          | White powder. Insoluble in water. Harmful if swallowed.   | 2687   |
| –      | T4                                 | TP1             | F-A, S-A               | Category A              | SGG10                         | Colourless liquid. Immiscible with water. Decomposes when heated, evolving highly toxic fumes. Toxic if swallowed, by skin contact or by inhalation.  | 2688   |

Part 3 – Dangerous Goods List, special provisions and exceptions

Chapter 3.2 – Dangerous Goods List

| UN No. | Proper shipping name (PSN)  | Class or division | Subsidiary hazard(s) | Packing group  | Special provisions      | Limited and excepted quantity provisions |                          | Packing          |                | IBC               |                 |
|--------|---|-------------------|----------------------|----------------|-------------------------|--|--------------------------|------------------|----------------|-------------------|-----------------|
|        |   |                   |                      |                |                         | Limited quantities (7a)                  | Excepted quantities (7b) | Instructions (8) | Provisions (9) | Instructions (10) | Provisions (11) |
| (1)    | (2)<br>3.1.2  | (3)<br>2.0        | (4)<br>2.0           | (5)<br>2.0.1.3 | (6)<br>3.3              | (7a)<br>3.4                              | (7b)<br>3.5              | (8)<br>4.1.4     | (9)<br>4.1.4   | (10)<br>4.1.4     | (11)<br>4.1.4   |
| 2689   | GLYCEROL <i>alpha</i> -MONOCHLOROXYDRIN                             | 6.1               | –                    | III            | –                       | 5 L                                      | E1                       | P001<br>LP01     | –              | IBC03             | –               |
| 2690   | <i>N,n</i> -BUTYLIMIDAZOLE  | 6.1               | –                    | II             | –                       | 100 mL                                   | E4                       | P001             | –              | IBC02             | –               |
| 2691   | PHOSPHORUS PENTABROMIDE   | 8                 | –                    | II             | –                       | 1 kg                                     | E0                       | P002             | –              | IBC08             | B4<br>B21       |
| 2692   | BORON TRIBROMIDE  | 8                 | –                    | I              | –                       | 0  | E0                       | P602             | –              | –                 | –               |
| 2693   | BISULPHITES, AQUEOUS SOLUTION, N.O.S.                               | 8                 | –                    | III            | 274                     | 5 L                                      | E1                       | P001<br>LP01     | –              | IBC03             | –               |
| 2698   | TETRAHYDROPHTHALIC ANHYDRIDES with more than 0.05% maleic anhydride | 8                 | –                    | III            | 29<br>169<br>939<br>973 | 5 kg                                     | E1                       | P002<br>LP02     | PP14           | IBC08             | B3              |
| 2699   | TRIFLUOROACETIC ACID  | 8                 | –                    | I              | –                       | 0  | E0                       | P001             | –              | –                 | –               |
| 2705   | 1-PENTOL  | 8                 | –                    | II             | –                       | 1 L                                      | E2                       | P001             | –              | IBC02             | –               |
| 2707   | DIMETHYLDIOXANES  | 3                 | –                    | II             | –                       | 1 L                                      | E2                       | P001             | –              | IBC02             | –               |
| 2707   | DIMETHYLDIOXANES  | 3                 | –                    | III            | 223                     | 5 L                                      | E1                       | P001<br>LP01     | –              | IBC03             | –               |
| 2709   | BUTYLBENZENES   | 3                 | –<br>P               | III            | –                       | 5 L                                      | E1                       | P001<br>LP01     | –              | IBC03             | –               |
| 2710   | DIPROPYL KETONE   | 3                 | –                    | III            | –                       | 5 L                                      | E1                       | P001<br>LP01     | –              | IBC03             | –               |
| 2713   | ACRIDINE  | 6.1               | –                    | III            | –                       | 5 kg                                     | E1                       | P002<br>LP02     | –              | IBC08             | B3              |
| 2714   | ZINC RESINATE   | 4.1               | –                    | III            | –                       | 5 kg                                     | E1                       | P002             | –              | IBC06             | –               |
| 2715   | ALUMINIUM RESINATE  | 4.1               | –                    | III            | –                       | 5 kg                                     | E1                       | P002             | –              | IBC06             | –               |
| 2716   | 1,4-BUTYNEEDIOL   | 6.1               | –                    | III            | –                       | 5 kg                                     | E1                       | P002<br>LP02     | –              | IBC08             | B3              |

| UN No. | Portable tanks and bulk containers |                 | EmS                    | Stowage and handling           | Segregation                  | Properties and observations   | UN No. |
|--------|------------------------------------|-----------------|------------------------|--------------------------------|------------------------------|---|--------|
|        | Tank instructions (12)             | Provisions (14) |                        |                                |                              |   |        |
| (1)    | (13)<br>4.2.5<br>4.3               | (14)<br>4.2.5   | (15)<br>5.4.3.4<br>7.8 | (16a)<br>7.1<br>7.3–7.7        | (16b)<br>7.2–7.7             | (17)  | (18)   |
| 2689   | T4                                 | TP1             | F-A, S-A               | Category A                     | –                            | Colourless liquid. Miscible with water. Toxic if swallowed, by skin contact or by inhalation.   | 2689   |
| 2690   | T7                                 | TP2             | F-A, S-A               | Category A                     | –                            | Colourless to amber mobile liquid. Miscible with water. Toxic if swallowed, by skin contact or by inhalation.   | 2690   |
| 2691   | T3                                 | TP33            | F-A, S-B               | Category B<br>SW1<br>SW2<br>H2 | SGG1<br>SG36<br>SG37<br>SG49 | Yellow hygroscopic crystals, evolving fumes in the air which are corrosive and heavier than air. Reacts violently with water, evolving hydrogen bromide, an irritating and corrosive gas apparent as white fumes. Reacts violently with ammonia, bases and many other substances and may cause fire and explosion. Decomposes when heated, evolving corrosive and toxic gases. In the presence of moisture, highly corrosive to most metals. Causes burns to skin, eyes and mucous membranes. | 2691   |
| 2692   | T20                                | TP2<br>TP13     | F-A, S-B               | Category C<br>SW1<br>H2        | SGG1<br>SG36<br>SG49         | Colourless fuming liquid. Reacts violently with water, evolving toxic and corrosive fumes. Decomposes when heated, evolving toxic fumes. In the presence of moisture, highly corrosive to most metals. Liquid and vapour cause severe burns to skin, eyes and mucous membranes.   | 2692   |
| 2693   | T7                                 | TP1<br>TP28     | F-A, S-B               | Category A<br>SW2              | SG35                         | Liquid with a pungent odour. Reacts with acids, evolving sulphur dioxide, a toxic gas. Causes burns to skin, eyes and mucous membranes.   | 2693   |
| 2698   | T1                                 | TP33            | F-A, S-B               | Category A                     | SGG1<br>SG36<br>SG49         | White crystalline powders. React with water, evolving heat and forming tetrahydrophthalic acid. Cause burns to skin, eyes and mucous membranes. When heated, evolve acrid fumes which are irritating to skin, eyes and mucous membranes.  | 2698   |
| 2699   | T10                                | TP2             | F-A, S-B               | Category B<br>SW1<br>SW2<br>H2 | SGG1<br>SG36<br>SG49         | Colourless, fuming, hygroscopic liquid with a pungent odour. Miscible with water. When heated to decomposition or in contact with acids, evolves toxic gases. In the presence of moisture, highly corrosive to most metals. Vapours are highly irritating to skin, eyes and mucous membranes. Liquid causes severe burns to skin, eyes and mucous membranes.  | 2699   |
| 2705   | T7                                 | TP2             | F-A, S-B               | Category B                     | SG20<br>SG21                 | Colourless liquid with a perceptible odour. May react in contact with acids and alkalis. Causes burns to skin, eyes and mucous membranes.   | 2705   |
| 2707   | T4                                 | TP1             | F-E, S-D               | Category B                     | –                            | Colourless liquids with a pungent odour. Partially miscible with water. React vigorously with oxidizing substances. Harmful by inhalation. Irritating to skin, eyes and mucous membranes.   | 2707   |
| 2707   | T2                                 | TP1             | F-E, S-D               | Category A                     | –                            | See entry above.  | 2707   |
| 2709   | T2                                 | TP2             | F-E, S-D               | Category A                     | –                            | Colourless liquids with an unpleasant odour. Flashpoint: 34°C to 60°C c.c. Explosive limits: 0.7% to 6.9%. Immiscible with water. Irritating to skin, eyes and mucous membranes.  | 2709   |
| 2710   | T2                                 | TP1             | F-E, S-D               | Category A                     | –                            | Colourless liquid. Flashpoint: 49°C c.c. Immiscible with water.   | 2710   |
| 2713   | T1                                 | TP33            | F-A, S-A               | Category A                     | –                            | Small colourless to yellowish crystals or needles. Sublimes at 100°C. Practically insoluble in water. Toxic if swallowed, by skin contact or by inhalation.   | 2713   |
| 2714   | T1                                 | TP33            | F-A, S-I               | Category A                     | SGG7                         | Powder or clear amber lumps. Insoluble in water. Liable to spontaneous heating. Irritating to skin and mucous membranes.  | 2714   |
| 2715   | T1                                 | TP33            | F-A, S-I               | Category A                     | –                            | Cream to brown coloured mass. Insoluble in water. Liable to spontaneous heating. Irritating to skin and mucous membranes.   | 2715   |
| 2716   | T1                                 | TP33            | F-A, S-A               | Category A                     | SG35<br>SG36<br>SG55         | White crystals. Melting point: 58°C. Soluble in water. Forms explosive mixtures with mercury salts, acids, alkaline compounds and halides. Toxic if swallowed, by skin contact or by inhalation.  | 2716   |

Part 3 – Dangerous Goods List, special provisions and exceptions

Chapter 3.2 – Dangerous Goods List

| UN No. | Proper shipping name (PSN) | Class or division | Subsidiary hazard(s) | Packing group  | Special provisions | Limited and excepted quantity provisions |                     | Packing      |              | IBC           |               |
|--------|----------------------------|-------------------|----------------------|----------------|--------------------|--|---------------------|--------------|--------------|---------------|---------------|
|        |                            |                   |                      |                |                    | Limited quantities                       | Excepted quantities | Instructions | Provisions   | Instructions  | Provisions    |
| (1)    | (2)<br>3.1.2               | (3)<br>2.0        | (4)<br>2.0           | (5)<br>2.0.1.3 | (6)<br>3.3         | (7a)<br>3.4                              | (7b)<br>3.5         | (8)<br>4.1.4 | (9)<br>4.1.4 | (10)<br>4.1.4 | (11)<br>4.1.4 |
| 2717   | CAMPHOR, synthetic         | 4.1               | –                    | III            | –                  | 5 kg                                     | E1                  | P002<br>LP02 | –            | IBC08         | B3            |
| 2719   | BARIIUM BROMATE            | 5.1               | 6.1                  | II             | –                  | 1 kg                                     | E2                  | P002         | –            | IBC08         | B4<br>B21     |
| 2720   | CHROMIUM NITRATE           | 5.1               | –                    | III            | –                  | 5 kg                                     | E1                  | P002<br>LP02 | –            | IBC08         | B3            |
| 2721   | COPPER CHLORATE            | 5.1               | –                    | II             | –                  | 1 kg                                     | E2                  | P002         | –            | IBC08         | B4<br>B21     |
| 2722   | LITHIUM NITRATE            | 5.1               | –                    | III            | –                  | 5 kg                                     | E1                  | P002<br>LP02 | –            | IBC08         | B3            |
| 2723   | MAGNESIUM CHLORATE         | 5.1               | –                    | II             | –                  | 1 kg                                     | E2                  | P002         | –            | IBC08         | B4<br>B21     |
| 2724   | MANGANESE NITRATE          | 5.1               | –                    | III            | –                  | 5 kg                                     | E1                  | P002<br>LP02 | –            | IBC08         | B3            |
| 2725   | NICKEL NITRATE             | 5.1               | –                    | III            | –                  | 5 kg                                     | E1                  | P002<br>LP02 | –            | IBC08         | B3            |
| 2726   | NICKEL NITRITE             | 5.1               | –                    | III            | –                  | 5 kg                                     | E1                  | P002<br>LP02 | –            | IBC08         | B3            |
| 2727   | THALLIUM NITRATE           | 6.1               | 5.1<br>P             | II             | –                  | 500 g                                    | E4                  | P002         | –            | IBC06         | B21           |
| 2728   | ZIRCONIUM NITRATE          | 5.1               | –                    | III            | –                  | 5 kg                                     | E1                  | P002<br>LP02 | –            | IBC08         | B3            |
| 2729   | HEXACHLOROBENZENE          | 6.1               | –                    | III            | –                  | 5 kg                                     | E1                  | P002<br>LP02 | –            | IBC08         | B3            |
| 2730   | NITROANISOLE, LIQUID       | 6.1               | –                    | III            | 279                | 5 L                                      | E1                  | P001<br>LP01 | –            | IBC03         | –             |
| 2732   | NITROBROMOBENZENES, LIQUID | 6.1               | –                    | III            | –                  | 5 L                                      | E1                  | P001<br>LP01 | –            | IBC03         | –             |

| UN No. | Portable tanks and bulk containers |               | EmS                    | Stowage and handling    | Segregation           | Properties and observations   | UN No. |
|--------|------------------------------------|---------------|------------------------|-------------------------|-----------------------|---|--------|
|        | Tank instructions                  | Provisions    |                        |                         |                       |   |        |
| (12)   | (13)<br>4.2.5<br>4.3               | (14)<br>4.2.5 | (15)<br>5.4.3.4<br>7.8 | (16a)<br>7.1<br>7.3–7.7 | (16b)<br>7.2–7.7      | (17)  | (18)   |
| –      | T1                                 | TP33          | F-A, S-I               | Category A              | –                     | Colourless or white crystals, granules or easily broken masses with a penetrating, pungent and aromatic odour. Slightly soluble in water. When heated, evolves flammable and explosive vapours. Harmful if swallowed.   | 2717   |
| –      | T3                                 | TP33          | F-H, S-Q               | Category A              | SGG3<br>SG38<br>SG49  | White crystals or powder. Slightly soluble in water. Reacts vigorously with sulphuric acid. Reacts fiercely with cyanides when heated or by friction. May form explosive mixtures with combustible material, powdered metals or ammonium compounds. These mixtures are sensitive to friction and are liable to ignite. When involved in a fire, may cause an explosion. Toxic if swallowed, by skin contact or by dust inhalation.  | 2719   |
| –      | T1                                 | TP33          | F-A, S-Q               | Category A              | –                     | Purple crystals. Mixtures with combustible material are readily ignited and may burn fiercely. Solutions in water are slightly corrosive. Harmful if swallowed.   | 2720   |
| –      | T3                                 | TP33          | F-H, S-Q               | Category A              | SGG4<br>SG38<br>SG49  | Blue-green deliquescent crystals or powder. Soluble in water. Reacts vigorously with sulphuric acid. Reacts fiercely with cyanides when heated or by friction. May form explosive mixtures with combustible material, powdered metals or ammonium compounds. These mixtures are sensitive to friction and are liable to ignite. When involved in a fire, may cause an explosion.  | 2721   |
| –      | T1                                 | TP33          | F-A, S-Q               | Category A              | –                     | Colourless deliquescent crystals. Soluble in water. Mixtures with combustible material are readily ignited and burn fiercely. Harmful if swallowed.   | 2722   |
| –      | T3                                 | TP33          | F-H, S-Q               | Category A              | SGG4<br>SG38<br>SG49  | White deliquescent crystals or powder. Soluble in water. Melting point: 35°C. Reacts vigorously with sulphuric acid. Reacts fiercely with cyanides when heated or by friction. May form explosive mixtures with combustible material, powdered metals or ammonium compounds. These mixtures are sensitive to friction and are liable to ignite. When involved in a fire, may cause an explosion. The cargoes should be protected from moisture prior to and after loading. If weather is inclement, hatches should be closed. | 2723   |
| –      | T1                                 | TP33          | F-A, S-Q               | Category A              | –                     | Pale pink deliquescent crystals. Soluble in water. Melting point between 26°C and 35°C. Mixtures with combustible material are readily ignited and may burn fiercely. Solutions in water are slightly corrosive. Harmful if swallowed.  | 2724   |
| –      | T1                                 | TP33          | F-A, S-Q               | Category A              | –                     | Green deliquescent crystals. Soluble in water. Melting point: 55°C. Mixtures with combustible material are readily ignited and may burn fiercely. Solutions in water are slightly corrosive. Harmful if swallowed.  | 2725   |
| –      | T1                                 | TP33          | F-A, S-Q               | Category A              | SGG12<br>SG38<br>SG49 | Reddish-yellow crystals. Decomposes if heated, giving off toxic nitrous fumes. Mixtures with combustible material are readily ignited and may burn fiercely. Mixtures with ammonium compounds or cyanides may explode. Harmful if swallowed.  | 2726   |
| –      | T3                                 | TP33          | F-A, S-Q               | Category A              | –                     | Colourless crystals. Soluble in water. Mixtures with combustible material are readily ignited and may burn fiercely. Toxic if swallowed, by skin contact or by dust inhalation.   | 2727   |
| –      | T1                                 | TP33          | F-A, S-Q               | Category A              | –                     | White crystals, flakes or powder. Soluble in water. Solutions in water are slightly corrosive. Harmful if swallowed.  | 2728   |
| –      | T1                                 | TP33          | F-A, S-A               | Category A              | –                     | White needle-like crystals. Insoluble in water. Decomposes when heated, evolving highly toxic fumes. Toxic if swallowed, by skin contact or by dust inhalation.   | 2729   |
| –      | T4                                 | TP1           | F-A, S-A               | Category A              | –                     | Light reddish or amber liquid. Immiscible with water. Toxic if swallowed, by skin contact or by inhalation.   | 2730   |
| –      | T4                                 | TP1           | F-A, S-A               | Category A              | –                     | Colourless to pale yellow liquids. Melting point of 1-BROMO-3-NITROBENZENE: 17°C. Immiscible with water. Toxic if swallowed, by skin contact or by inhalation.  | 2732   |



Part 3 – Dangerous Goods List, special provisions and exceptions

Chapter 3.2 – Dangerous Goods List

| UN No. | Proper shipping name (PSN)   | Class or division | Subsidiary hazard(s) | Packing group  | Special provisions | Limited and excepted quantity provisions |                     | Packing      |              | IBC           |               |
|--------|--|-------------------|----------------------|----------------|--------------------|--|---------------------|--------------|--------------|---------------|---------------|
|        |  |                   |                      |                |                    | Limited quantities                       | Excepted quantities | Instructions | Provisions   | Instructions  | Provisions    |
| (1)    | (2)<br>3.1.2   | (3)<br>2.0        | (4)<br>2.0           | (5)<br>2.0.1.3 | (6)<br>3.3         | (7a)<br>3.4                              | (7b)<br>3.5         | (8)<br>4.1.4 | (9)<br>4.1.4 | (10)<br>4.1.4 | (11)<br>4.1.4 |
| 2733   | AMINES, FLAMMABLE, CORROSIVE, N.O.S. or POLYAMINES, FLAMMABLE, CORROSIVE, N.O.S.                 | 3                 | 8                    | I              | 274                | 0  | E0                  | P001         | -            | -             | -             |
| 2733   | AMINES, FLAMMABLE, CORROSIVE, N.O.S. or POLYAMINES, FLAMMABLE, CORROSIVE, N.O.S.                 | 3                 | 8                    | II             | 274                | 1 L                                      | E2                  | P001         | -            | IBC02         | -             |
| 2733   | AMINES, FLAMMABLE, CORROSIVE, N.O.S. or POLYAMINES, FLAMMABLE, CORROSIVE, N.O.S.                 | 3                 | 8                    | III            | 223<br>274         | 5 L                                      | E1                  | P001         | -            | IBC03         | -             |
| 2734   | AMINES, LIQUID, CORROSIVE, FLAMMABLE, N.O.S. or POLYAMINES, LIQUID, CORROSIVE, FLAMMABLE, N.O.S. | 8                 | 3                    | I              | 274                | 0  | E0                  | P001         | -            | -             | -             |
| 2734   | AMINES, LIQUID, CORROSIVE, FLAMMABLE, N.O.S. or POLYAMINES, LIQUID, CORROSIVE, FLAMMABLE, N.O.S. | 8                 | 3                    | II             | 274                | 1 L                                      | E2                  | P001         | -            | IBC02         | -             |
| 2735   | AMINES, LIQUID, CORROSIVE, N.O.S. or POLYAMINES, LIQUID, CORROSIVE, N.O.S.                       | 8                 | -                    | I              | 274                | 0  | E0                  | P001         | -            | -             | -             |
| 2735   | AMINES, LIQUID, CORROSIVE, N.O.S. or POLYAMINES, LIQUID, CORROSIVE, N.O.S.                       | 8                 | -                    | II             | 274                | 1 L                                      | E2                  | P001         | -            | IBC02         | -             |
| 2735   | AMINES, LIQUID, CORROSIVE, N.O.S. or POLYAMINES, LIQUID, CORROSIVE, N.O.S.                       | 8                 | -                    | III            | 223<br>274         | 5 L                                      | E1                  | P001<br>LP01 | -            | IBC03         | -             |
| 2738   | N-BUTYLANILINE   | 6.1               | -                    | II             | -                  | 100 mL                                   | E4                  | P001         | -            | IBC02         | -             |
| 2739   | BUTYRIC ANHYDRIDE  | 8                 | -                    | III            | -                  | 5 L                                      | E1                  | P001<br>LP01 | -            | IBC03         | -             |
| 2740   | n-PROPYL CHLOROFORMATE   | 6.1               | 3/8                  | I              | -                  | 0  | E0                  | P602         | -            | -             | -             |
| 2741   | BARIUM HYPOCHLORITE with more than 22% available chlorine  | 5.1               | 6.1                  | II             | -                  | 1 kg                                     | E2                  | P002         | -            | IBC08         | B4<br>B21     |

| UN No. | Portable tanks and bulk containers |               | EmS                    | Stowage and handling    | Segregation                                  | Properties and observations  | UN No. |
|--------|------------------------------------|---------------|------------------------|-------------------------|--|--|--------|
|        | Tank instructions                  | Provisions    |                        |                         |  |  |        |
| (12)   | (13)<br>4.2.5<br>4.3               | (14)<br>4.2.5 | (15)<br>5.4.3.4<br>7.8 | (16a)<br>7.1<br>7.3-7.7 | (16b)<br>7.2-7.7                             | (17)   | (18)   |
| -      | T14                                | TP1<br>TP27   | F-E, S-C               | Category D<br>SW2       | SGG18<br>SG35                                | Colourless to yellowish liquids with an unpleasant odour. Some are very volatile. Miscible with water. Corrosive to most metals, especially to copper and its alloys. When involved in a fire, evolve toxic gases. React violently with acids. Harmful by inhalation. Cause burns to skin, eyes and mucous membranes.  | 2733   |
| -      | T11                                | TP1<br>TP27   | F-E, S-C               | Category B<br>SW2       | SGG18<br>SG35                                | See entry above.   | 2733   |
| -      | T7                                 | TP1<br>TP28   | F-E, S-C               | Category A<br>SW2       | SGG18<br>SG35                                | See entry above.   | 2733   |
| -      | T14                                | TP2<br>TP27   | F-E, S-C               | Category A              | SGG18<br>SG35                                | Colourless to yellowish flammable liquids or solutions with a pungent odour. Miscible with water. When involved in a fire, evolve toxic gases. Corrosive to most metals, especially to copper and its alloys. React violently with acids. Cause burns to skin, eyes and mucous membranes.  | 2734   |
| -      | T11                                | TP2<br>TP27   | F-E, S-C               | Category A              | SGG18<br>SG35                                | See entry above.   | 2734   |
| -      | T14                                | TP2<br>TP27   | F-A, S-B               | Category A              | SGG18<br>SG35                                | Colourless to yellowish liquids or solutions with a pungent odour. Miscible with or soluble in water. When involved in a fire, evolve toxic gases. Corrosive to most metals, especially to copper and its alloys. React violently with acids. Cause burns to skin, eyes and mucous membranes.  | 2735   |
| -      | T11                                | TP1<br>TP27   | F-A, S-B               | Category A              | SGG18<br>SG35                                | See entry above.   | 2735   |
| -      | T7                                 | TP1<br>TP28   | F-A, S-B               | Category A              | SGG18<br>SG35                                | See entry above.   | 2735   |
| -      | T7                                 | TP2           | F-A, S-A               | Category A              | SG17   | Amber liquid with a perceptible odour. Immiscible with water. May react vigorously with oxidizing substances. Toxic if swallowed, by skin contact or by inhalation.  | 2738   |
| -      | T4                                 | TP1           | F-A, S-B               | Category A              | SGG1<br>SG36<br>SG49                         | Colourless liquid. Decomposes in water to form butyric acid.   | 2739   |
| -      | T20                                | TP2<br>TP13   | F-E, S-C               | Category B<br>SW2       | SGG1<br>SG8<br>SG36<br>SG49                  | Colourless flammable liquid. Flashpoint: 28°C c.c. Decomposed by water, generating propyl alcohol. Highly toxic if swallowed, by skin contact or by inhalation. Causes burns to skin, eyes and mucous membranes.   | 2740   |
| -      | T3                                 | TP33          | F-H, S-Q               | Category B              | SGG8<br>SG35<br>SG38<br>SG49<br>SG53<br>SG60 | White powder with pungent odour. Reacts with acids, evolving chlorine, an irritating, corrosive and toxic gas. Reacts fiercely with cyanides when heated or by friction. May form explosive mixtures with combustible material, powdered metals or ammonium compounds. These mixtures are sensitive to friction and are liable to ignite. When involved in a fire, may cause an explosion. Toxic if swallowed, by skin contact or by dust inhalation. Dust irritates mucous membranes. Contact with eyes will cause serious injury to the cornea (blindness) if not treated immediately by using copious amounts of water followed by medical attention. | 2741   |

Part 3 – Dangerous Goods List, special provisions and exceptions

Chapter 3.2 – Dangerous Goods List

| UN No. | Proper shipping name (PSN)                          | Class or division | Subsidiary hazard(s) | Packing group  | Special provisions | Limited and excepted quantity provisions |                     | Packing      |              | IBC           |               |
|--------|---|-------------------|----------------------|----------------|--------------------|--|---------------------|--------------|--------------|---------------|---------------|
|        |   |                   |                      |                |                    | Limited quantities                       | Excepted quantities | Instructions | Provisions   | Instructions  | Provisions    |
| (1)    | (2)<br>3.1.2  | (3)<br>2.0        | (4)<br>2.0           | (5)<br>2.0.1.3 | (6)<br>3.3         | (7a)<br>3.4                              | (7b)<br>3.5         | (8)<br>4.1.4 | (9)<br>4.1.4 | (10)<br>4.1.4 | (11)<br>4.1.4 |
| 2742   | CHLOROFORMATES, TOXIC, CORROSIVE, FLAMMABLE, N.O.S. | 6.1               | 3/8                  | II             | 274                | 100 mL                                   | E4                  | P001         | –            | IBC01         | –             |
| 2743   | n-BUTYL CHLOROFORMATE                               | 6.1               | 3/8                  | II             | –                  | 100 mL                                   | E0                  | P001         | –            | –             | –             |
| 2744   | CYCLOBUTYL CHLOROFORMATE                            | 6.1               | 3/8                  | II             | –                  | 100 mL                                   | E4                  | P001         | –            | IBC01         | –             |
| 2745   | CHLOROMETHYL CHLOROFORMATE                          | 6.1               | 8                    | II             | –                  | 100 mL                                   | E4                  | P001         | –            | IBC02         | –             |
| 2746   | PHENYL CHLOROFORMATE                                | 6.1               | 8                    | II             | –                  | 100 mL                                   | E4                  | P001         | –            | IBC02         | –             |
| 2747   | tert-BUTYLCYCLOHEXYL CHLOROFORMATE                  | 6.1               | –                    | III            | –                  | 5 L                                      | E1                  | P001<br>LP01 | –            | IBC03         | –             |
| 2748   | 2-ETHYLHEXYL CHLOROFORMATE                          | 6.1               | 8                    | II             | –                  | 100 mL                                   | E4                  | P001         | –            | IBC02         | –             |
| 2749   | TETRAMETHYLSILANE                                   | 3                 | –                    | I              | –                  | 0  | E0                  | P001         | –            | –             | –             |
| 2750   | 1,3-DICHLOROPROPANOL-2                              | 6.1               | –                    | II             | –                  | 100 mL                                   | E4                  | P001         | –            | IBC02         | –             |
| 2751   | DIETHYLTHIOPHOSPHORYL CHLORIDE                      | 8                 | –                    | II             | –                  | 1 L                                      | E2                  | P001         | –            | IBC02         | –             |
| 2752   | 1,2-EPOXY-3-ETHOXYPROPANE                           | 3                 | –                    | III            | –                  | 5 L                                      | E1                  | P001<br>LP01 | –            | IBC03         | –             |
| 2753   | N-ETHYLBENZYL TOLUIDINES, LIQUID                    | 6.1               | –                    | III            | –                  | 5 L                                      | E1                  | P001<br>LP01 | –            | IBC03         | –             |
| 2754   | N-ETHYL TOLUIDINES                                  | 6.1               | –                    | II             | –                  | 100 mL                                   | E4                  | P001         | –            | IBC02         | –             |
| 2757   | CARBAMATE PESTICIDE, SOLID, TOXIC                   | 6.1               | –                    | I              | 61<br>274          | 0  | E5                  | P002         | –            | IBC07         | B1            |
| 2757   | CARBAMATE PESTICIDE, SOLID, TOXIC                   | 6.1               | –                    | II             | 61<br>274          | 500 g                                    | E4                  | P002         | –            | IBC08         | B4<br>B21     |

| UN No. | Portable tanks and bulk containers |               | EmS                    | Stowage and handling                 | Segregation                        | Properties and observations   | UN No. |
|--------|------------------------------------|---------------|------------------------|--------------------------------------|------------------------------------|---|--------|
|        | Tank instructions                  | Provisions    |                        |                                      |                                    |   |        |
| (12)   | (13)<br>4.2.5<br>4.3               | (14)<br>4.2.5 | (15)<br>5.4.3.4<br>7.8 | (16a)<br>7.1<br>7.3–7.7              | (16b)<br>7.2–7.7                   | (17)  | (18)   |
| –      | –                                  | –             | F-E, S-C               | Category A<br>SW1<br>SW2<br>H1<br>H2 | SGG1<br>SG5<br>SG8<br>SG36<br>SG49 | A wide range of colourless to yellowish flammable liquids. React and decompose with water or heat, evolving hydrogen chloride, an irritating and corrosive gas apparent as white fumes. Flashpoint: cyclohexyl chloroformate: 53°C c.c. Toxic if swallowed, by skin contact or by inhalation. Cause burns to skin, eyes and mucous membranes. | 2742   |
| –      | T20                                | TP2<br>TP13   | F-E, S-C               | Category A<br>SW1<br>SW2<br>H1<br>H2 | SGG1<br>SG5<br>SG8<br>SG36<br>SG49 | A wide range of colourless to yellowish flammable liquids. React and decompose with water or heat, evolving hydrogen chloride, an irritating and corrosive gas apparent as white fumes. Flashpoint: 32°C c.c. to 39°C c.c. Toxic if swallowed, by skin contact or by inhalation. Cause burns to skin, eyes and mucous membranes.              | 2743   |
| –      | T7                                 | TP2<br>TP13   | F-E, S-C               | Category A<br>SW1<br>SW2<br>H1<br>H2 | SGG1<br>SG5<br>SG8<br>SG36<br>SG49 | A wide range of colourless to yellowish flammable liquids. React and decompose with water or heat, evolving hydrogen chloride, an irritating and corrosive gas apparent as white fumes. Flashpoint: 38°C c.c. Toxic if swallowed, by skin contact or by inhalation. Cause burns to skin, eyes and mucous membranes.                           | 2744   |
| –      | T7                                 | TP2<br>TP13   | F-A, S-B               | Category A<br>SW1<br>SW2<br>H1<br>H2 | SGG1<br>SG36<br>SG49               | A wide range of colourless to yellowish liquids. React and decompose with water or heat, evolving hydrogen chloride, an irritating and corrosive gas apparent as white fumes. Toxic if swallowed, by skin contact or by inhalation. Cause burns to skin, eyes and mucous membranes.   | 2745   |
| –      | T7                                 | TP2<br>TP13   | F-A, S-B               | Category A<br>SW1<br>SW2<br>H1<br>H2 | SGG1<br>SG36<br>SG49               | A wide range of colourless to yellowish liquids. React and decompose with water or heat, evolving hydrogen chloride, an irritating and corrosive gas apparent as white fumes. Toxic if swallowed, by skin contact or by inhalation. Cause burns to skin, eyes and mucous membranes.   | 2746   |
| –      | T4                                 | TP1           | F-A, S-A               | Category A<br>SW1<br>H1<br>H2        | –                                  | Colourless to yellowish liquid. Reacts with water or decomposes if heated, evolving hydrogen chloride, an irritating and corrosive gas apparent as white fumes. Toxic if swallowed, by skin contact or by inhalation.   | 2747   |
| –      | T7                                 | TP2<br>TP13   | F-A, S-B               | Category A<br>SW1<br>SW2<br>H1<br>H2 | SGG1<br>SG36<br>SG49               | A wide range of colourless to yellowish liquids. React and decompose with water or heat, evolving hydrogen chloride, an irritating and corrosive gas apparent as white fumes. Toxic if swallowed, by skin contact or by inhalation. Cause burns to skin, eyes and mucous membranes.   | 2748   |
| –      | T14                                | TP2           | F-E, S-D               | Category D                           | –                                  | Colourless, volatile liquid. Flashpoint: below –18°C c.c. Boiling point: 27°C. Immiscible with water. Harmful if swallowed or by inhalation. Irritating to skin, eyes and mucous membranes.   | 2749   |
| –      | T7                                 | TP2           | F-A, S-A               | Category A<br>SW1<br>SW2<br>H2       | –                                  | Colourless, slightly viscous liquid with a chloroform-like odour. Immiscible with water. Decomposes when heated, evolving extremely toxic fumes (phosgene). Toxic if swallowed, by skin contact or by inhalation.   | 2750   |
| –      | T7                                 | TP2           | F-A, S-B               | Category D<br>SW1<br>SW2<br>H2       | SGG1<br>SG36<br>SG49               | Colourless liquid with a perceptible odour. Reacts slowly with water, forming hydrochloric acid. When involved in a fire, evolves toxic gases (hydrogen chloride and sulphur dioxide). Vapour highly irritating to eyes and mucous membranes. Liquid causes burns to skin, eyes and mucous membranes.   | 2751   |
| –      | T2                                 | TP1           | F-E, S-D               | Category A                           | –                                  | Immiscible with water. Flashpoint: 47°C c.c. Irritating to skin, eyes and mucous membranes.   | 2752   |
| –      | T7                                 | TP1           | F-A, S-A               | Category A                           | –                                  | Liquids with a strong odour. Immiscible with water. Toxic if swallowed, by skin contact or by inhalation.   | 2753   |
| –      | T7                                 | TP2           | F-A, S-A               | Category A                           | –                                  | Colourless to light amber liquids. Immiscible with water. Toxic if swallowed, by skin contact or by inhalation.   | 2754   |
| –      | T6                                 | TP33          | F-A, S-A               | Category A<br>SW2                    | –                                  | Solid pesticides present a very wide range of toxic hazard. Toxic if swallowed, by skin contact or by inhalation.   | 2757   |
| –      | T3                                 | TP33          | F-A, S-A               | Category A<br>SW2                    | –                                  | See entry above.  | 2757   |

Part 3 – Dangerous Goods List, special provisions and exceptions

Chapter 3.2 – Dangerous Goods List

| UN No. | Proper shipping name (PSN)  | Class or division | Subsidiary hazard(s) | Packing group  | Special provisions | Limited and excepted quantity provisions |                     | Packing      |              | IBC           |               |
|--------|---|-------------------|----------------------|----------------|--------------------|--|---------------------|--------------|--------------|---------------|---------------|
|        |   |                   |                      |                |                    | Limited quantities                       | Excepted quantities | Instructions | Provisions   | Instructions  | Provisions    |
| (1)    | (2)<br>3.1.2  | (3)<br>2.0        | (4)<br>2.0           | (5)<br>2.0.1.3 | (6)<br>3.3         | (7a)<br>3.4                              | (7b)<br>3.5         | (8)<br>4.1.4 | (9)<br>4.1.4 | (10)<br>4.1.4 | (11)<br>4.1.4 |
| 2757   | CARBAMATE PESTICIDE, SOLID, TOXIC   | 6.1               | –                    | III            | 61<br>223<br>274   | 5 kg                                     | E1                  | P002<br>LP02 | –            | IBC08         | B3            |
| 2758   | CARBAMATE PESTICIDE, LIQUID, FLAMMABLE, TOXIC, flashpoint less than 23°C      | 3                 | 6.1                  | I              | 61<br>274          | 0  | E0                  | P001         | –            | –             | –             |
| 2758   | CARBAMATE PESTICIDE, LIQUID, FLAMMABLE, TOXIC, flashpoint less than 23°C      | 3                 | 6.1                  | II             | 61<br>274          | 1 L                                      | E2                  | P001         | –            | IBC02         | –             |
| 2759   | ARSENICAL PESTICIDE, SOLID, TOXIC   | 6.1               | –                    | I              | 61<br>274          | 0  | E5                  | P002         | –            | IBC07         | B1            |
| 2759   | ARSENICAL PESTICIDE, SOLID, TOXIC   | 6.1               | –                    | II             | 61<br>274          | 500 g                                    | E4                  | P002         | –            | IBC08         | B4<br>B21     |
| 2759   | ARSENICAL PESTICIDE, SOLID, TOXIC   | 6.1               | –                    | III            | 61<br>223<br>274   | 5 kg                                     | E1                  | P002<br>LP02 | –            | IBC08         | B3            |
| 2760   | ARSENICAL PESTICIDE, LIQUID, FLAMMABLE, TOXIC, flashpoint less than 23°C      | 3                 | 6.1                  | I              | 61<br>274          | 0  | E0                  | P001         | –            | –             | –             |
| 2760   | ARSENICAL PESTICIDE, LIQUID, FLAMMABLE, TOXIC, flashpoint less than 23°C      | 3                 | 6.1                  | II             | 61<br>274          | 1 L                                      | E2                  | P001         | –            | IBC02         | –             |
| 2761   | ORGANOCHLORINE PESTICIDE, SOLID, TOXIC  | 6.1               | –                    | I              | 61<br>274          | 0  | E5                  | P002         | –            | IBC07         | B1            |
| 2761   | ORGANOCHLORINE PESTICIDE, SOLID, TOXIC  | 6.1               | –                    | II             | 61<br>274          | 500 g                                    | E4                  | P002         | –            | IBC08         | B4<br>B21     |
| 2761   | ORGANOCHLORINE PESTICIDE, SOLID, TOXIC  | 6.1               | –                    | III            | 61<br>223<br>274   | 5 kg                                     | E1                  | P002<br>LP02 | –            | IBC08         | B3            |
| 2762   | ORGANOCHLORINE PESTICIDE, LIQUID, FLAMMABLE, TOXIC, flashpoint less than 23°C | 3                 | 6.1                  | I              | 61<br>274          | 0  | E0                  | P001         | –            | –             | –             |
| 2762   | ORGANOCHLORINE PESTICIDE, LIQUID, FLAMMABLE, TOXIC, flashpoint less than 23°C | 3                 | 6.1                  | II             | 61<br>274          | 1 L                                      | E2                  | P001         | –            | IBC02         | –             |
| 2763   | TRIAZINE PESTICIDE, SOLID, TOXIC  | 6.1               | –                    | I              | 61<br>274          | 0  | E5                  | P002         | –            | IBC07         | B1            |
| 2763   | TRIAZINE PESTICIDE, SOLID, TOXIC  | 6.1               | –                    | II             | 61<br>274          | 500 g                                    | E4                  | P002         | –            | IBC08         | B4<br>B21     |
| 2763   | TRIAZINE PESTICIDE, SOLID, TOXIC  | 6.1               | –                    | III            | 61<br>223<br>274   | 5 kg                                     | E1                  | P002         | –            | IBC08         | B3            |
| 2764   | TRIAZINE PESTICIDE, LIQUID, FLAMMABLE, TOXIC, flashpoint less than 23°C       | 3                 | 6.1                  | I              | 61<br>274          | 0  | E0                  | P001         | –            | –             | –             |
| 2764   | TRIAZINE PESTICIDE, LIQUID, FLAMMABLE, TOXIC, flashpoint less than 23°C       | 3                 | 6.1                  | II             | 61<br>274          | 1 L                                      | E2                  | P001         | –            | IBC02         | –             |
| 2771   | THIOCARBAMATE PESTICIDE, SOLID, TOXIC   | 6.1               | –                    | I              | 61<br>274          | 0  | E5                  | P002         | –            | IBC07         | B1            |
| 2771   | THIOCARBAMATE PESTICIDE, SOLID, TOXIC   | 6.1               | –                    | II             | 61<br>274          | 500 g                                    | E4                  | P002         | –            | IBC08         | B4<br>B21     |
| 2771   | THIOCARBAMATE PESTICIDE, SOLID, TOXIC   | 6.1               | –                    | III            | 61<br>223<br>274   | 5 kg                                     | E1                  | P002<br>LP02 | –            | IBC08         | B3            |

| UN No. | Portable tanks and bulk containers |                     | EmS                    | Stowage and handling    | Segregation      | Properties and observations   | UN No. |
|--------|------------------------------------|---------------------|------------------------|-------------------------|------------------|---|--------|
|        | Tank instructions                  | Provisions          |                        |                         |                  |   |        |
| (12)   | (13)<br>4.2.5<br>4.3               | (14)<br>4.2.5       | (15)<br>5.4.3.4<br>7.8 | (16a)<br>7.1<br>7.3–7.7 | (16b)<br>7.2–7.7 | (17)  | (18)   |
| –      | T1                                 | TP33                | F-A, S-A               | Category A<br>SW2       | –                | Solid pesticides present a very wide range of toxic hazard. Toxic if swallowed, by skin contact or by inhalation.   | 2757   |
| –      | T14                                | TP2<br>TP13<br>TP27 | F-E, S-D               | Category B<br>SW2       | –                | Pesticides frequently contain petroleum or coal tar distillates, or other flammable liquids. Miscibility with water depends upon the composition. Toxic if swallowed, by skin contact or by inhalation. | 2758   |
| –      | T11                                | TP2<br>TP13<br>TP27 | F-E, S-D               | Category B<br>SW2       | –                | See entry above.  | 2758   |
| –      | T6                                 | TP33                | F-A, S-A               | Category A<br>SW2       | –                | Solid pesticides present a very wide range of toxic hazard. Toxic if swallowed, by skin contact or by inhalation.   | 2759   |
| –      | T3                                 | TP33                | F-A, S-A               | Category A<br>SW2       | –                | See entry above.  | 2759   |
| –      | T1                                 | TP33                | F-A, S-A               | Category A<br>SW2       | –                | See entry above.  | 2759   |
| –      | T14                                | TP2<br>TP13<br>TP27 | F-E, S-D               | Category B<br>SW2       | –                | Pesticides frequently contain petroleum or coal tar distillates, or other flammable liquids. Miscibility with water depends upon the composition. Toxic if swallowed, by skin contact or by inhalation. | 2760   |
| –      | T11                                | TP2<br>TP13<br>TP27 | F-E, S-D               | Category B<br>SW2       | –                | See entry above.  | 2760   |
| –      | T6                                 | TP33                | F-A, S-A               | Category A<br>SW2       | –                | Solid pesticides present a very wide range of toxic hazard. Toxic if swallowed, by skin contact or by inhalation.   | 2761   |
| –      | T3                                 | TP33                | F-A, S-A               | Category A<br>SW2       | –                | See entry above.  | 2761   |
| –      | T1                                 | TP33                | F-A, S-A               | Category A<br>SW2       | –                | See entry above.  | 2761   |
| –      | T14                                | TP2<br>TP13<br>TP27 | F-E, S-D               | Category B<br>SW2       | –                | Pesticides frequently contain petroleum or coal tar distillates, or other flammable liquids. Miscibility with water depends upon the composition. Toxic if swallowed, by skin contact or by inhalation. | 2762   |
| –      | T11                                | TP2<br>TP13<br>TP27 | F-E, S-D               | Category B<br>SW2       | –                | See entry above.  | 2762   |
| –      | T6                                 | TP33                | F-A, S-A               | Category A<br>SW2       | –                | Solid pesticides present a very wide range of toxic hazard. Toxic if swallowed, by skin contact or by inhalation.   | 2763   |
| –      | T3                                 | TP33                | F-A, S-A               | Category A<br>SW2       | –                | See entry above.  | 2763   |
| –      | T3                                 | TP33                | F-A, S-A               | Category A<br>SW2       | –                | See entry above.  | 2763   |
| –      | T14                                | TP2<br>TP13<br>TP27 | F-E, S-D               | Category B<br>SW2       | –                | Pesticides frequently contain petroleum or coal tar distillates, or other flammable liquids. Miscibility with water depends upon the composition. Toxic if swallowed, by skin contact or by inhalation. | 2764   |
| –      | T11                                | TP2<br>TP13<br>TP27 | F-E, S-D               | Category B<br>SW2       | –                | See entry above.  | 2764   |
| –      | T6                                 | TP33                | F-A, S-A               | Category A<br>SW2       | –                | Solid pesticides present a very wide range of toxic hazard. Toxic if swallowed, by skin contact or by inhalation.   | 2771   |
| –      | T3                                 | TP33                | F-A, S-A               | Category A<br>SW2       | –                | See entry above.  | 2771   |
| –      | T1                                 | TP33                | F-A, S-A               | Category A<br>SW2       | –                | See entry above.  | 2771   |

Part 3 – Dangerous Goods List, special provisions and exceptions

Chapter 3.2 – Dangerous Goods List

| UN No. | Proper shipping name (PSN)   | Class or division | Subsidiary hazard(s) | Packing group  | Special provisions | Limited and excepted quantity provisions |                     | Packing      |              | IBC           |               |
|--------|--|-------------------|----------------------|----------------|--------------------|--|---------------------|--------------|--------------|---------------|---------------|
|        |  |                   |                      |                |                    | Limited quantities                       | Excepted quantities | Instructions | Provisions   | Instructions  | Provisions    |
| (1)    | (2)<br>3.1.2   | (3)<br>2.0        | (4)<br>2.0           | (5)<br>2.0.1.3 | (6)<br>3.3         | (7a)<br>3.4                              | (7b)<br>3.5         | (8)<br>4.1.4 | (9)<br>4.1.4 | (10)<br>4.1.4 | (11)<br>4.1.4 |
| 2772   | THIOCARBAMATE PESTICIDE, LIQUID, FLAMMABLE, TOXIC, flashpoint less than 23°C           | 3                 | 6.1                  | I              | 61<br>274          | 0  | E0                  | P001         | -            | -             | -             |
| 2772   | THIOCARBAMATE PESTICIDE, LIQUID, FLAMMABLE, TOXIC, flashpoint less than 23°C           | 3                 | 6.1                  | II             | 61<br>274          | 1 L                                      | E2                  | P001         | -            | IBC02         | -             |
| 2775   | COPPER BASED PESTICIDE, SOLID, TOXIC   | 6.1               | -                    | I              | 61<br>274          | 0  | E5                  | P002         | -            | IBC07         | B1            |
| 2775   | COPPER BASED PESTICIDE, SOLID, TOXIC   | 6.1               | -                    | II             | 61<br>274          | 500 g                                    | E4                  | P002         | -            | IBC08         | B4<br>B21     |
| 2775   | COPPER BASED PESTICIDE, SOLID, TOXIC   | 6.1               | -                    | III            | 61<br>223<br>274   | 5 kg                                     | E1                  | P002<br>LP02 | -            | IBC08         | B3            |
| 2776   | COPPER BASED PESTICIDE, LIQUID, FLAMMABLE, TOXIC, flashpoint less than 23°C            | 3                 | 6.1                  | I              | 61<br>274          | 0  | E0                  | P001         | -            | -             | -             |
| 2776   | COPPER BASED PESTICIDE, LIQUID, FLAMMABLE, TOXIC, flashpoint less than 23°C            | 3                 | 6.1                  | II             | 61<br>274          | 1 L                                      | E2                  | P001         | -            | IBC02         | -             |
| 2777   | MERCURY BASED PESTICIDE, SOLID, TOXIC  | 6.1               | -<br>P               | I              | 61<br>274          | 0  | E5                  | P002         | -            | IBC07         | B1            |
| 2777   | MERCURY BASED PESTICIDE, SOLID, TOXIC  | 6.1               | -<br>P               | II             | 61<br>274          | 500 g                                    | E4                  | P002         | -            | IBC08         | B4<br>B21     |
| 2777   | MERCURY BASED PESTICIDE, SOLID, TOXIC  | 6.1               | -<br>P               | III            | 61<br>223<br>274   | 5 kg                                     | E1                  | P002<br>LP02 | -            | IBC08         | B3            |
| 2778   | MERCURY BASED PESTICIDE, LIQUID, FLAMMABLE, TOXIC, flashpoint less than 23°C           | 3                 | 6.1<br>P             | I              | 61<br>274          | 0  | E0                  | P001         | -            | -             | -             |
| 2778   | MERCURY BASED PESTICIDE, LIQUID, FLAMMABLE, TOXIC, flashpoint less than 23°C           | 3                 | 6.1<br>P             | II             | 61<br>274          | 1 L                                      | E2                  | P001         | -            | IBC02         | -             |
| 2779   | SUBSTITUTED NITROPHENOL PESTICIDE, SOLID, TOXIC  | 6.1               | -                    | I              | 61<br>274          | 0  | E5                  | P002         | -            | IBC07         | B1            |
| 2779   | SUBSTITUTED NITROPHENOL PESTICIDE, SOLID, TOXIC  | 6.1               | -                    | II             | 61<br>274          | 500 g                                    | E4                  | P002         | -            | IBC08         | B4<br>B21     |
| 2779   | SUBSTITUTED NITROPHENOL PESTICIDE, SOLID, TOXIC  | 6.1               | -                    | III            | 61<br>223<br>274   | 5 kg                                     | E1                  | P002<br>LP02 | -            | IBC08         | B3            |
| 2780   | SUBSTITUTED NITROPHENOL PESTICIDE, LIQUID, FLAMMABLE, TOXIC, flashpoint less than 23°C | 3                 | 6.1                  | I              | 61<br>274          | 0  | E0                  | P001         | -            | -             | -             |
| 2780   | SUBSTITUTED NITROPHENOL PESTICIDE, LIQUID, FLAMMABLE, TOXIC, flashpoint less than 23°C | 3                 | 6.1                  | II             | 61<br>274          | 1 L                                      | E2                  | P001         | -            | IBC02         | -             |
| 2781   | BIPYRIDILIUM PESTICIDE, SOLID, TOXIC   | 6.1               | -                    | I              | 61<br>274          | 0  | E5                  | P002         | -            | IBC07         | B1            |
| 2781   | BIPYRIDILIUM PESTICIDE, SOLID, TOXIC   | 6.1               | -                    | II             | 61<br>274          | 500 g                                    | E4                  | P002         | -            | IBC08         | B4<br>B21     |
| 2781   | BIPYRIDILIUM PESTICIDE, SOLID, TOXIC   | 6.1               | -                    | III            | 61<br>223<br>274   | 5 kg                                     | E1                  | P002<br>LP02 | -            | IBC08         | B3            |

| UN No. | Portable tanks and bulk containers |                     | EmS                    | Stowage and handling    | Segregation      | Properties and observations   | UN No. |
|--------|------------------------------------|---------------------|------------------------|-------------------------|------------------|---|--------|
|        | Tank instructions                  | Provisions          |                        |                         |                  |   |        |
| (12)   | (13)<br>4.2.5<br>4.3               | (14)<br>4.2.5       | (15)<br>5.4.3.4<br>7.8 | (16a)<br>7.1<br>7.3-7.7 | (16b)<br>7.2-7.7 | (17)  | (18)   |
| -      | T14                                | TP2<br>TP13<br>TP27 | F-E, S-D               | Category B<br>SW2       | -                | Pesticides frequently contain petroleum or coal tar distillates, or other flammable liquids. Miscibility with water depends upon the composition. Toxic if swallowed, by skin contact or by inhalation. | 2772   |
| -      | T11                                | TP2<br>TP13<br>TP27 | F-E, S-D               | Category B<br>SW2       | -                | See entry above.  | 2772   |
| -      | T6                                 | TP33                | F-A, S-A               | Category A<br>SW2       | -                | Solid pesticides present a very wide range of toxic hazard. Toxic if swallowed, by skin contact or by inhalation.   | 2775   |
| -      | T3                                 | TP33                | F-A, S-A               | Category A<br>SW2       | -                | See entry above.  | 2775   |
| -      | T1                                 | TP33                | F-A, S-A               | Category A<br>SW2       | -                | See entry above.  | 2775   |
| -      | T14                                | TP2<br>TP13<br>TP27 | F-E, S-D               | Category B<br>SW2       | -                | Pesticides frequently contain petroleum or coal tar distillates, or other flammable liquids. Miscibility with water depends upon the composition. Toxic if swallowed, by skin contact or by inhalation. | 2776   |
| -      | T11                                | TP2<br>TP13<br>TP27 | F-E, S-D               | Category B<br>SW2       | -                | See entry above.  | 2776   |
| -      | T6                                 | TP33                | F-A, S-A               | Category A<br>SW2       | SGG7<br>SGG11    | Solid pesticides present a very wide range of toxic hazard. Toxic if swallowed, by skin contact or by inhalation.   | 2777   |
| -      | T3                                 | TP33                | F-A, S-A               | Category A<br>SW2       | SGG7<br>SGG11    | See entry above.  | 2777   |
| -      | T1                                 | TP33                | F-A, S-A               | Category A<br>SW2       | SGG7<br>SGG11    | See entry above.  | 2777   |
| -      | T14                                | TP2<br>TP13<br>TP27 | F-E, S-D               | Category B<br>SW2       | SGG7<br>SGG11    | Pesticides frequently contain petroleum or coal tar distillates, or other flammable liquids. Miscibility with water depends upon the composition. Toxic if swallowed, by skin contact or by inhalation. | 2778   |
| -      | T11                                | TP2<br>TP13<br>TP27 | F-E, S-D               | Category B<br>SW2       | SGG7<br>SGG11    | See entry above.  | 2778   |
| -      | T6                                 | TP33                | F-A, S-A               | Category A<br>SW2       | -                | Solid pesticides present a very wide range of toxic hazard. Toxic if swallowed, by skin contact or by inhalation.   | 2779   |
| -      | T3                                 | TP33                | F-A, S-A               | Category A<br>SW2       | -                | See entry above.  | 2779   |
| -      | T1                                 | TP33                | F-A, S-A               | Category A<br>SW2       | -                | See entry above.  | 2779   |
| -      | T14                                | TP2<br>TP13<br>TP27 | F-E, S-D               | Category B<br>SW2       | -                | Pesticides frequently contain petroleum or coal tar distillates, or other flammable liquids. Miscibility with water depends upon the composition. Toxic if swallowed, by skin contact or by inhalation. | 2780   |
| -      | T11                                | TP2<br>TP13<br>TP27 | F-E, S-D               | Category B<br>SW2       | -                | See entry above.  | 2780   |
| -      | T6                                 | TP33                | F-A, S-A               | Category A<br>SW2       | -                | Solid pesticides present a very wide range of toxic hazard. Toxic if swallowed, by skin contact or by inhalation.   | 2781   |
| -      | T3                                 | TP33                | F-A, S-A               | Category A<br>SW2       | -                | See entry above.  | 2781   |
| -      | T1                                 | TP33                | F-A, S-A               | Category A<br>SW2       | -                | See entry above.  | 2781   |



Part 3 – Dangerous Goods List, special provisions and exceptions

Chapter 3.2 – Dangerous Goods List

| UN No. | Proper shipping name (PSN)  | Class or division | Subsidiary hazard(s) | Packing group  | Special provisions | Limited and excepted quantity provisions |                          | Packing          |                | IBC               |                 |
|--------|---|-------------------|----------------------|----------------|--------------------|--|--------------------------|------------------|----------------|-------------------|-----------------|
|        |   |                   |                      |                |                    | Limited quantities (7a)                  | Excepted quantities (7b) | Instructions (8) | Provisions (9) | Instructions (10) | Provisions (11) |
| (1)    | (2)<br>3.1.2  | (3)<br>2.0        | (4)<br>2.0           | (5)<br>2.0.1.3 | (6)<br>3.3         | (7a)<br>3.4                              | (7b)<br>3.5              | (8)<br>4.1.4     | (9)<br>4.1.4   | (10)<br>4.1.4     | (11)<br>4.1.4   |
| 2782   | BIPYRIDILIUM PESTICIDE, LIQUID, FLAMMABLE, TOXIC, flashpoint less than 23°C     | 3                 | 6.1                  | I              | 61<br>274          | 0  | E0                       | P001             | -              | -                 | -               |
| 2782   | BIPYRIDILIUM PESTICIDE, LIQUID, FLAMMABLE, TOXIC, flashpoint less than 23°C     | 3                 | 6.1                  | II             | 61<br>274          | 1 L                                      | E2                       | P001             | -              | IBC02             | -               |
| 2783   | ORGANOPHOSPHORUS PESTICIDE, SOLID, TOXIC  | 6.1               | -                    | I              | 61<br>274          | 0  | E5                       | P002             | -              | IBC07             | B1              |
| 2783   | ORGANOPHOSPHORUS PESTICIDE, SOLID, TOXIC  | 6.1               | -                    | II             | 61<br>274          | 500 g                                    | E4                       | P002             | -              | IBC08             | B4<br>B21       |
| 2783   | ORGANOPHOSPHORUS PESTICIDE, SOLID, TOXIC  | 6.1               | -                    | III            | 61<br>223<br>274   | 5 kg                                     | E1                       | P002<br>LP02     | -              | IBC08             | B3              |
| 2784   | ORGANOPHOSPHORUS PESTICIDE, LIQUID, FLAMMABLE, TOXIC, flashpoint less than 23°C | 3                 | 6.1                  | I              | 61<br>274          | 0  | E0                       | P001             | -              | -                 | -               |
| 2784   | ORGANOPHOSPHORUS PESTICIDE, LIQUID, FLAMMABLE, TOXIC, flashpoint less than 23°C | 3                 | 6.1                  | II             | 61<br>274          | 1 L                                      | E2                       | P001             | -              | IBC02             | -               |
| 2785   | 4-THIAPENTANAL  | 6.1               | -                    | III            | -                  | 5 L                                      | E1                       | P001<br>LP01     | PP31           | IBC03             | -               |
| 2786   | ORGANOTIN PESTICIDE, SOLID, TOXIC   | 6.1               | -<br>P               | I              | 61<br>274          | 0  | E5                       | P002             | -              | IBC07             | B1              |
| 2786   | ORGANOTIN PESTICIDE, SOLID, TOXIC   | 6.1               | -<br>P               | II             | 61<br>274          | 500 g                                    | E4                       | P002             | -              | IBC08             | B4<br>B21       |
| 2786   | ORGANOTIN PESTICIDE, SOLID, TOXIC   | 6.1               | -<br>P               | III            | 61<br>223<br>274   | 5 kg                                     | E1                       | P002<br>LP02     | -              | IBC08             | B3              |
| 2787   | ORGANOTIN PESTICIDE, LIQUID, FLAMMABLE, TOXIC, flashpoint less than 23°C        | 3                 | 6.1<br>P             | I              | 61<br>274          | 0  | E0                       | P001             | -              | -                 | -               |
| 2787   | ORGANOTIN PESTICIDE, LIQUID, FLAMMABLE, TOXIC, flashpoint less than 23°C        | 3                 | 6.1<br>P             | II             | 61<br>274          | 1 L                                      | E2                       | P001             | -              | IBC02             | -               |
| 2788   | ORGANOTIN COMPOUND, LIQUID, N.O.S.  | 6.1               | -<br>P               | I              | 43<br>274          | 0  | E5                       | P001             | -              | -                 | -               |
| 2788   | ORGANOTIN COMPOUND, LIQUID, N.O.S.  | 6.1               | -<br>P               | II             | 43<br>274          | 100 mL                                   | E4                       | P001             | -              | IBC02             | -               |
| 2788   | ORGANOTIN COMPOUND, LIQUID, N.O.S.  | 6.1               | -<br>P               | III            | 43<br>223<br>274   | 5 L                                      | E1                       | P001<br>LP01     | -              | IBC03             | -               |
| 2789   | ACETIC ACID, GLACIAL or ACETIC ACID SOLUTION, more than 80% acid, by mass       | 8                 | 3                    | II             | -                  | 1 L                                      | E2                       | P001             | -              | IBC02             | -               |
| 2790   | ACETIC ACID SOLUTION, not less than 50% but not more than 80% acid, by mass     | 8                 | -                    | II             | -                  | 1 L                                      | E2                       | P001             | -              | IBC02             | -               |
| 2790   | ACETIC ACID SOLUTION, more than 10% and less than 50% acid, by mass             | 8                 | -                    | III            | -                  | 5 L                                      | E1                       | P001<br>LP01     | -              | IBC03             | -               |

| UN No. | Portable tanks and bulk containers |                     | EmS                    | Stowage and handling    | Segregation          | Properties and observations  | UN No. |
|--------|------------------------------------|---------------------|------------------------|-------------------------|----------------------|--|--------|
|        | Tank instructions (12)             | Provisions (14)     |                        |                         |                      |  |        |
| (1)    | (13)<br>4.2.5<br>4.3               | (14)<br>4.2.5       | (15)<br>5.4.3.4<br>7.8 | (16a)<br>7.1<br>7.3-7.7 | (16b)<br>7.2-7.7     | (17)   | (18)   |
| 2782   | T14                                | TP2<br>TP13<br>TP27 | F-E, S-D               | Category B<br>SW2       | -                    | Pesticides frequently contain petroleum or coal tar distillates, or other flammable liquids. Miscibility with water depends upon the composition. Toxic if swallowed, by skin contact or by inhalation.  | 2782   |
| 2782   | T11                                | TP2<br>TP13<br>TP27 | F-E, S-D               | Category B<br>SW2       | -                    | See entry above.   | 2782   |
| 2783   | T6                                 | TP33                | F-A, S-A               | Category A<br>SW2       | -                    | Solid pesticides present a very wide range of toxic hazard. Toxic if swallowed, by skin contact or by inhalation.  | 2783   |
| 2783   | T3                                 | TP33                | F-A, S-A               | Category A<br>SW2       | -                    | See entry above.   | 2783   |
| 2783   | T1                                 | TP33                | F-A, S-A               | Category A<br>SW2       | -                    | See entry above.   | 2783   |
| 2784   | T14                                | TP2<br>TP13<br>TP27 | F-E, S-D               | Category B<br>SW2       | -                    | Pesticides frequently contain petroleum or coal tar distillates, or other flammable liquids. Miscibility with water depends upon the composition. Toxic if swallowed, by skin contact or by inhalation.  | 2784   |
| 2784   | T11                                | TP2<br>TP13<br>TP27 | F-E, S-D               | Category B<br>SW2       | -                    | See entry above.   | 2784   |
| 2785   | T4                                 | TP1                 | F-A, S-A               | Category D<br>SW1       | SG20<br>SG21         | Colourless liquid with an extremely foul and persistent odour. Miscible with water. Decomposes rapidly in contact with acids and bases. Toxic if swallowed, by skin contact or by inhalation.  | 2785   |
| 2786   | T6                                 | TP33                | F-A, S-A               | Category A<br>SW2       | -                    | Solid pesticides present a very wide range of toxic hazard. Toxic if swallowed, by skin contact or by inhalation.  | 2786   |
| 2786   | T3                                 | TP33                | F-A, S-A               | Category A<br>SW2       | -                    | See entry above.   | 2786   |
| 2786   | T1                                 | TP33                | F-A, S-A               | Category A<br>SW2       | -                    | See entry above.   | 2786   |
| 2787   | T14                                | TP2<br>TP13<br>TP27 | F-E, S-D               | Category B<br>SW2       | -                    | Pesticides frequently contain petroleum or coal tar distillates, or other flammable liquids. Miscibility with water depends upon the composition. Toxic if swallowed, by skin contact or by inhalation.  | 2787   |
| 2787   | T11                                | TP2<br>TP13<br>TP27 | F-E, S-D               | Category B<br>SW2       | -                    | See entry above.   | 2787   |
| 2788   | T14                                | TP2<br>TP13<br>TP27 | F-A, S-A               | Category A<br>SW2       | -                    | A wide variety of toxic liquids. Toxic if swallowed, by skin contact or by inhalation.   | 2788   |
| 2788   | T11                                | TP2<br>TP13<br>TP27 | F-A, S-A               | Category A<br>SW2       | -                    | See entry above.   | 2788   |
| 2788   | T7                                 | TP2<br>TP28         | F-A, S-A               | Category A<br>SW2       | -                    | See entry above.   | 2788   |
| 2789   | T7                                 | TP2                 | F-E, S-C               | Category A              | SGG1<br>SG36<br>SG49 | Colourless flammable liquid with a pungent odour. When pure, crystallizes below 16°C. Flashpoint: 40°C c.c. (pure product), 60°C c.c. (80% solution). Explosive limits: 4% to 17%. Miscible with water. Corrosive to lead and most other metals. Corrosive to skin, eyes and mucous membranes. | 2789   |
| 2790   | T7                                 | TP2                 | F-A, S-B               | Category A              | SGG1<br>SG36<br>SG49 | Colourless liquid with a pungent odour. Miscible with water. Corrosive to lead and most other metals. Corrosive to skin, eyes and mucous membranes.  | 2790   |
| 2790   | T4                                 | TP1                 | F-A, S-B               | Category A              | SGG1<br>SG36<br>SG49 | See entry above.   | 2790   |

Part 3 – Dangerous Goods List, special provisions and exceptions

Chapter 3.2 – Dangerous Goods List

| UN No. | Proper shipping name (PSN)   | Class or division | Subsidiary hazard(s) | Packing group  | Special provisions | Limited and excepted quantity provisions |                     | Packing      |                     | IBC           |               |
|--------|--|-------------------|----------------------|----------------|--------------------|--|---------------------|--------------|---------------------|---------------|---------------|
|        |  |                   |                      |                |                    | Limited quantities                       | Excepted quantities | Instructions | Provisions          | Instructions  | Provisions    |
| (1)    | (2)<br>3.1.2   | (3)<br>2.0        | (4)<br>2.0           | (5)<br>2.0.1.3 | (6)<br>3.3         | (7a)<br>3.4                              | (7b)<br>3.5         | (8)<br>4.1.4 | (9)<br>4.1.4        | (10)<br>4.1.4 | (11)<br>4.1.4 |
| 2793   | FERROUS METAL BORINGS, SHAVINGS, TURNINGS or CUTTINGS in a form liable to self-heating | 4.2               | –                    | III            | 223<br>931         | 0  | E1                  | P003<br>LP02 | PP20<br>PP100<br>L3 | IBC08         | B4<br>B6      |
| 2794   | BATTERIES, WET, FILLED WITH ACID, electric storage                                     | 8                 | –                    | –              | 295                | 1 L                                      | E0                  | P801         | –                   | –             | –             |
| △ 2795 | BATTERIES, WET, FILLED WITH ALKALI, electric storage                                   | 8                 | –                    | –              | 295<br>401         | 1 L                                      | E0                  | P801         | –                   | –             | –             |
| 2796   | SULPHURIC ACID with not more than 51% acid or BATTERY FLUID, ACID                      | 8                 | –                    | II             | –                  | 1 L                                      | E2                  | P001         | –                   | IBC02         | B20           |
| 2797   | BATTERY FLUID, ALKALI  | 8                 | –                    | II             | –                  | 1 L                                      | E2                  | P001         | –                   | IBC02         | –             |
| 2798   | PHENYLPHOSPHORUS DICHLORIDE  | 8                 | –                    | II             | –                  | 1 L                                      | E0                  | P001         | –                   | IBC02         | –             |
| 2799   | PHENYLPHOSPHORUS THIODICHLORIDE  | 8                 | –                    | II             | –                  | 1 L                                      | E0                  | P001         | –                   | IBC02         | –             |
| 2800   | BATTERIES, WET, NON-SPILLABLE, electric storage  | 8                 | –                    | –              | 238                | 1 L                                      | E0                  | P003         | PP16                | –             | –             |
| 2801   | DYE, LIQUID, CORROSIVE, N.O.S. or DYE INTERMEDIATE, LIQUID, CORROSIVE, N.O.S.          | 8                 | –                    | I              | 274                | 0  | E0                  | P001         | –                   | –             | –             |
| 2801   | DYE, LIQUID, CORROSIVE, N.O.S. or DYE INTERMEDIATE, LIQUID, CORROSIVE, N.O.S.          | 8                 | –                    | II             | 274                | 1 L                                      | E2                  | P001         | –                   | IBC02         | –             |
| 2801   | DYE, LIQUID, CORROSIVE, N.O.S. or DYE INTERMEDIATE, LIQUID, CORROSIVE, N.O.S.          | 8                 | –                    | III            | 223<br>274         | 5 L                                      | E1                  | P001<br>LP01 | –                   | IBC03         | –             |
| 2802   | COPPER CHLORIDE  | 8                 | –<br>P               | III            | –                  | 500 g                                    | E1                  | P002<br>LP02 | –                   | IBC08         | B3            |
| △ 2803 | GALLIUM  | 8                 | –                    | III            | 365                | 5 kg                                     | E0                  | P800         | PP41                | –             | –             |

| UN No. | Portable tanks and bulk containers |               | EmS                    | Stowage and handling    | Segregation           | Properties and observations  | UN No. |
|--------|------------------------------------|---------------|------------------------|-------------------------|-----------------------|--|--------|
|        | Tank instructions                  | Provisions    |                        |                         |                       |  |        |
| (12)   | (13)<br>4.2.5<br>4.3               | (14)<br>4.2.5 | (15)<br>5.4.3.4<br>7.8 | (16a)<br>7.1<br>7.3–7.7 | (16b)<br>7.2–7.7      | (17)   | (18)   |
| –      | BK2                                | –             | F-G, S-J               | Category A<br>H1        | SG26                  | These cargoes are liable to self-heating and to ignite spontaneously, particularly when in a finely divided form, wet or contaminated with such materials as unsaturated cutting oil, oily rags and other combustible matter. Self-heating or inadequate ventilation may cause dangerous depletion of oxygen in the stowage spaces. Excessive amounts of cast iron borings or organic materials may encourage heating. The swarf should be protected from moisture prior to and after loading. If, during loading, the weather is inclement, hatches should be closed or otherwise protected to keep the material dry. | 2793   |
| –      | –                                  | –             | F-A, S-B               | Category A<br>SW16      | SGG1<br>SG36<br>SG49  | Metal plates immersed in acid electrolyte in a glass, hard rubber or plastics receptacle. When electrically charged, may cause fire through short-circuiting of terminals. Acid electrolyte is corrosive to most metals. Causes burns to skin, eyes and mucous membranes. Used batteries being transported for disposal or reclamation should be carefully checked prior to shipment to ensure the integrity of each battery and its suitability for transport.  | 2794   |
| –      | –                                  | –             | F-A, S-B               | Category A<br>SW16      | SGG18<br>SG35         | Metal plates immersed in alkaline electrolyte in a glass, hard rubber or plastics receptacle. When electrically charged, may cause fire through short-circuiting of terminals. Alkaline electrolyte is corrosive to aluminium, zinc and tin. Reacts violently with acids. Causes burns to skin, eyes and mucous membranes. Used batteries being transported for disposal or reclamation should be carefully checked prior to shipment to ensure the integrity of each battery and its suitability for transport.   | 2795 △ |
| –      | T8                                 | TP2           | F-A, S-B               | Category B              | SGG1<br>SG36<br>SG49  | Colourless liquid, mixture not exceeding 1.405 relative density. Highly corrosive to most metals. Causes burns to skin, eyes and mucous membranes.   | 2796   |
| –      | T7                                 | TP2<br>TP28   | F-A, S-B               | Category A              | SGG18<br>SG22<br>SG35 | Reacts violently with acids. Reacts with ammonium salts, evolving ammonia gas. Corrosive to aluminium, zinc and tin.   | 2797   |
| –      | T7                                 | TP2           | F-A, S-B               | Category B<br>SW2       | SGG1<br>SG36<br>SG49  | Colourless liquid. Causes burns to skin, eyes and mucous membranes.  | 2798   |
| –      | T7                                 | TP2           | F-A, S-B               | Category B<br>SW2       | SGG1<br>SG36<br>SG49  | Colourless liquid which fumes slightly in air. Reacts with water or steam, evolving toxic and flammable vapours. Causes burns to skin, eyes and mucous membranes.  | 2799   |
| –      | –                                  | –             | F-A, S-B               | Category A              | –                     | Metal plates immersed in gelled alkaline or acid electrolyte in a glass, hard rubber or plastics receptacle of a non-spillable type. When electrically charged, may cause fire through short-circuiting of terminals. Cause burns to skin, eyes and mucous membranes.  | 2800   |
| –      | T14                                | TP2<br>TP27   | F-A, S-B               | Category A              | –                     | A wide range of corrosive liquids. Cause burns to skin, eyes and mucous membranes.   | 2801   |
| –      | T11                                | TP2<br>TP27   | F-A, S-B               | Category A              | –                     | See entry above.   | 2801   |
| –      | T7                                 | TP1<br>TP28   | F-A, S-B               | Category A              | –                     | See entry above.   | 2801   |
| –      | T1                                 | TP33          | F-A, S-B               | Category A              | SGG1<br>SG36<br>SG49  | White to yellow-brown crystals or powder. Partially to fully soluble in water. Corrosive to steel. Causes burns to skin, eyes and mucous membranes.  | 2802   |
| –      | T1                                 | TP33          | F-A, S-B               | Category B<br>SW1       | –                     | Silvery-white metallic element that melts at 29°C, becoming a bright, shiny liquid. Insoluble in water. Highly corrosive to aluminium. Harmful if swallowed, by skin contact or by inhalation. Special care should be taken if a leakage occurs when carried in aluminium freight containers. Carriage should be prohibited in hovercraft and other ships constructed from aluminium.  | 2803 △ |

Part 3 – Dangerous Goods List, special provisions and exceptions

Chapter 3.2 – Dangerous Goods List

| UN No. | Proper shipping name (PSN)             | Class or division | Subsidiary hazard(s) | Packing group  | Special provisions | Limited and excepted quantity provisions |                     | Packing      |              | IBC           |               |
|--------|--|-------------------|----------------------|----------------|--------------------|--|---------------------|--------------|--------------|---------------|---------------|
|        |  |                   |                      |                |                    | Limited quantities                       | Excepted quantities | Instructions | Provisions   | Instructions  | Provisions    |
| (1)    | (2)<br>3.1.2                           | (3)<br>2.0        | (4)<br>2.0           | (5)<br>2.0.1.3 | (6)<br>3.3         | (7a)<br>3.4                              | (7b)<br>3.5         | (8)<br>4.1.4 | (9)<br>4.1.4 | (10)<br>4.1.4 | (11)<br>4.1.4 |
| 2805   | LITHIUM HYDRIDE, FUSED SOLID           | 4.3               | –                    | II             | –                  | 500 g                                    | E2                  | P410         | PP31<br>PP40 | IBC04         | –             |
| 2806   | LITHIUM NITRIDE                        | 4.3               | –                    | I              | –                  | 0  | E0                  | P403         | PP31         | IBC04         | B1            |
| 2807   | MAGNETIZED MATERIAL                    | 9                 | –                    | –              | 960                | –  | –                   | –            | –            | –             | –             |
| 2809   | MERCURY                                | 8                 | 6.1                  | III            | 365                | 5 kg                                     | E0                  | P800         | –            | –             | –             |
| 2810   | TOXIC LIQUID, ORGANIC, N.O.S.          | 6.1               | –                    | I              | 274<br>315         | 0  | E5                  | P001         | –            | –             | –             |
| 2810   | TOXIC LIQUID, ORGANIC, N.O.S.          | 6.1               | –                    | II             | 274                | 100 mL                                   | E4                  | P001         | –            | IBC02         | –             |
| 2810   | TOXIC LIQUID, ORGANIC, N.O.S.          | 6.1               | –                    | III            | 223<br>274         | 5 L                                      | E1                  | P001<br>LP01 | –            | IBC03         | –             |
| 2811   | TOXIC SOLID, ORGANIC, N.O.S.           | 6.1               | –                    | I              | 274                | 0  | E5                  | P002         | –            | IBC99         | –             |
| 2811   | TOXIC SOLID, ORGANIC, N.O.S.           | 6.1               | –                    | II             | 274                | 500 g                                    | E4                  | P002         | –            | IBC08         | B4<br>B21     |
| 2811   | TOXIC SOLID, ORGANIC, N.O.S.           | 6.1               | –                    | III            | 223<br>274         | 5 kg                                     | E1                  | P002         | –            | IBC08         | B3            |
| 2812   | SODIUM ALUMINATE, SOLID                | 8                 | –                    | –              | 960                | –  | –                   | –            | –            | –             | –             |
| 2813   | WATER-REACTIVE SOLID, N.O.S.           | 4.3               | –                    | I              | 274                | 0  | E0                  | P403         | PP31         | IBC99         | –             |
| 2813   | WATER-REACTIVE SOLID, N.O.S.           | 4.3               | –                    | II             | 274                | 500 g                                    | E2                  | P410         | PP31<br>PP40 | IBC07         | B4<br>B21     |
| 2813   | WATER-REACTIVE SOLID, N.O.S.           | 4.3               | –                    | III            | 223<br>274         | 1 kg                                     | E1                  | P410         | PP31         | IBC08         | B4            |
| 2814   | INFECTIOUS SUBSTANCE, AFFECTING HUMANS | 6.2               | –                    | –              | 318<br>341         | 0  | E0                  | P620         | –            | –             | –             |
| 2815   | N-AMINOETHYLPIPERAZINE                 | 8                 | 6.1                  | III            | –                  | 5 L                                      | E1                  | P001<br>LP01 | –            | IBC03         | –             |
| 2817   | AMMONIUM HYDROGEN-DIFLUORIDE SOLUTION  | 8                 | 6.1                  | II             | –                  | 1 L                                      | E2                  | P001         | –            | IBC02         | B20           |
| 2817   | AMMONIUM HYDROGEN-DIFLUORIDE SOLUTION  | 8                 | 6.1                  | III            | 223                | 5 L                                      | E1                  | P001         | –            | IBC03         | –             |

| UN No. | Portable tanks and bulk containers |                     | EmS                    | Stowage and handling           | Segregation                  | Properties and observations   | UN No. |
|--------|------------------------------------|---------------------|------------------------|--------------------------------|------------------------------|---|--------|
|        | Tank instructions                  | Provisions          |                        |                                |                              |   |        |
| (12)   | (13)<br>4.2.5<br>4.3               | (14)<br>4.2.5       | (15)<br>5.4.3.4<br>7.8 | (16a)<br>7.1<br>7.3–7.7        | (16b)<br>7.2–7.7             | (17)  | (18)   |
| –      | T3                                 | TP33                | F-G, S-N               | Category E<br>H1               | SG26<br>SG35                 | White, crystalline mass. Reacts with water, moisture or acids, evolving hydrogen which may be ignited by the heat of the reaction.  | 2805   |
| –      | –                                  | –                   | F-A, S-O               | Category E                     | –                            | Brownish-red crystals or fine, free-flowing powder. Reacts slowly with water to form lithium hydroxide and ammonia.   | 2806   |
| –      | –                                  | –                   | –                      | –                              | –                            | Not subject to the provisions of this Code but may be subject to provisions governing the transport of dangerous goods by other modes.  | 2807   |
| –      | –                                  | –                   | F-A, S-B               | Category B<br>SW2              | SGG7<br>SGG11<br>SG24        | A silvery metallic element occurring in the liquid state at normal temperatures. Relative density: 13.546. Melting point: –39°C. Highly corrosive to aluminium. Toxic if swallowed, by skin contact or by inhalation. Special care should be taken if a leakage occurs during transport, especially when carried in breakable packages and in aluminium freight containers. Carriage should be prohibited in hovercraft and other ships constructed from aluminium. | 2809   |
| –      | T14                                | TP2<br>TP13<br>TP27 | F-A, S-A               | Category B<br>SW2              | –                            | Toxic if swallowed, by skin contact or by inhalation.   | 2810   |
| –      | T11                                | TP2<br>TP13<br>TP27 | F-A, S-A               | Category B<br>SW2              | –                            | See entry above.  | 2810   |
| –      | T7                                 | TP1<br>TP28         | F-A, S-A               | Category A<br>SW2              | –                            | See entry above.  | 2810   |
| –      | T6                                 | TP33                | F-A, S-A               | Category B                     | –                            | Toxic if swallowed, by skin contact or by inhalation.   | 2811   |
| –      | T3                                 | TP33                | F-A, S-A               | Category B                     | –                            | See entry above.  | 2811   |
| –      | T1                                 | TP33                | F-A, S-A               | Category A                     | –                            | See entry above.  | 2811   |
| –      | –                                  | –                   | –                      | –                              | –                            | Not subject to the provisions of this Code but may be subject to provisions governing the transport of dangerous goods by other modes.  | 2812   |
| –      | T9                                 | TP7<br>TP33         | F-G, S-N               | Category E<br>SW2<br>H1        | SG26                         | –   | 2813   |
| –      | T3                                 | TP33                | F-G, S-N               | Category E<br>SW2<br>H1        | SG26                         | –   | 2813   |
| –      | T1                                 | TP33                | F-G, S-N               | Category E<br>SW2<br>H1        | SG26                         | –   | 2813   |
| –      | BK2                                | –                   | F-A, S-T               | Category E<br>SW2<br>H1<br>H5  | SG50                         | Substances which are dangerous to humans or to humans and animals.  | 2814   |
| –      | T4                                 | TP1                 | F-A, S-B               | Category B<br>SW1<br>SW2<br>H2 | SG35<br>SG50                 | Yellow liquid. Miscible with water. Corrosive to skin, eyes and mucous membranes. Toxic if swallowed, by skin contact or by inhalation.   | 2815   |
| –      | T8                                 | TP2<br>TP13         | F-A, S-B               | Category B<br>SW2              | SGG1<br>SGG2<br>SG36<br>SG49 | Colourless liquid. Miscible with water. Highly corrosive to most metals and glass. Toxic if swallowed, by skin contact or by inhalation. Causes burns to skin, eyes and mucous membranes.   | 2817   |
| –      | T4                                 | TP1<br>TP13         | F-A, S-B               | Category B<br>SW2              | SGG1<br>SGG2<br>SG36<br>SG49 | See entry above.  | 2817   |



Part 3 – Dangerous Goods List, special provisions and exceptions

Chapter 3.2 – Dangerous Goods List

| UN No. | Proper shipping name (PSN)     | Class or division | Subsidiary hazard(s) | Packing group  | Special provisions | Limited and excepted quantity provisions |                     | Packing              |              | IBC           |               |
|--------|--------------------------------|-------------------|----------------------|----------------|--------------------|--|---------------------|----------------------|--------------|---------------|---------------|
|        |                                |                   |                      |                |                    | Limited quantities                       | Excepted quantities | Instructions         | Provisions   | Instructions  | Provisions    |
| (1)    | (2)<br>3.1.2                   | (3)<br>2.0        | (4)<br>2.0           | (5)<br>2.0.1.3 | (6)<br>3.3         | (7a)<br>3.4                              | (7b)<br>3.5         | (8)<br>4.1.4         | (9)<br>4.1.4 | (10)<br>4.1.4 | (11)<br>4.1.4 |
| 2818   | AMMONIUM POLYSULPHIDE SOLUTION | 8                 | 6.1                  | II             | –                  | 1 L                                      | E2                  | P001                 | –            | IBC02         | –             |
| 2818   | AMMONIUM POLYSULPHIDE SOLUTION | 8                 | 6.1                  | III            | 223                | 5 L                                      | E1                  | P001                 | –            | IBC03         | –             |
| 2819   | AMYL ACID PHOSPHATE            | 8                 | –                    | III            | –                  | 5 L                                      | E1                  | P001<br>LP01         | –            | IBC03         | –             |
| 2820   | BUTYRIC ACID                   | 8                 | –                    | III            | –                  | 5 L                                      | E1                  | P001<br>LP01         | –            | IBC03         | –             |
| 2821   | PHENOL SOLUTION                | 6.1               | –                    | II             | –                  | 100 mL                                   | E4                  | P001                 | –            | IBC02         | –             |
| 2821   | PHENOL SOLUTION                | 6.1               | –                    | III            | 223                | 5 L                                      | E1                  | P001<br>LP01         | –            | IBC03         | –             |
| 2822   | 2-CHLOROPYRIDINE               | 6.1               | –                    | II             | –                  | 100 mL                                   | E4                  | P001                 | –            | IBC02         | –             |
| 2823   | CROTONIC ACID, SOLID           | 8                 | –                    | III            | –                  | 5 kg                                     | E1                  | P002<br>LP02         | –            | IBC08         | B3<br>B21     |
| 2826   | ETHYL CHLOROTHIOFORMATE        | 8                 | 3<br>P               | II             | –                  | 0  | E0                  | P001                 | –            | –             | –             |
| 2829   | CAPROIC ACID                   | 8                 | –                    | III            | –                  | 5 L                                      | E1                  | P001<br>LP01         | –            | IBC03         | –             |
| 2830   | LITHIUM FERROSILICON           | 4.3               | –                    | II             | –                  | 500 g                                    | E2                  | P410<br>PP31<br>PP40 | –            | IBC07         | B4<br>B21     |
| 2831   | 1,1,1-TRICHLOROETHANE          | 6.1               | –                    | III            | –                  | 5 L                                      | E1                  | P001<br>LP01         | –            | IBC03         | –             |
| 2834   | PHOSPHOROUS ACID               | 8                 | –                    | III            | –                  | 5 kg                                     | E1                  | P002<br>LP02         | –            | IBC08         | B3            |
| 2835   | SODIUM ALUMINIUM HYDRIDE       | 4.3               | –                    | II             | –                  | 500 g                                    | E0                  | P410<br>PP31<br>PP40 | –            | IBC04         | –             |
| 2837   | BISULPHATES, AQUEOUS SOLUTION  | 8                 | –                    | II             | –                  | 1 L                                      | E2                  | P001                 | –            | IBC02         | –             |
| 2837   | BISULPHATES, AQUEOUS SOLUTION  | 8                 | –                    | III            | 223                | 5 L                                      | E1                  | P001<br>LP01         | –            | IBC03         | –             |
| 2838   | VINYL BUTYRATE, STABILIZED     | 3                 | –                    | II             | 386                | 1 L                                      | E2                  | P001                 | –            | IBC02         | –             |
| 2839   | ALDOL                          | 6.1               | –                    | II             | –                  | 100 mL                                   | E4                  | P001                 | –            | IBC02         | –             |

| UN No. | Portable tanks and bulk containers |               | EmS                    | Stowage and handling           | Segregation           | Properties and observations   | UN No. |
|--------|------------------------------------|---------------|------------------------|--------------------------------|-----------------------|---|--------|
|        | Tank instructions                  | Provisions    |                        |                                |                       |   |        |
| (12)   | (13)<br>4.2.5<br>4.3               | (14)<br>4.2.5 | (15)<br>5.4.3.4<br>7.8 | (16a)<br>7.1<br>7.3–7.7        | (16b)<br>7.2–7.7      | (17)  | (18)   |
| –      | T7                                 | TP2<br>TP13   | F-A, S-B               | Category B<br>SW1<br>SW2<br>H2 | SGG2<br>SGG18<br>SG35 | Unstable yellowish liquid with a foul odour (of rotten eggs). Miscible with water. Reacts violently with acids. Decomposes in contact with acids, evolving hydrogen sulphide, a toxic and flammable gas. Toxic if swallowed, by skin contact or by inhalation. Causes burns to skin, eyes and mucous membranes. | 2818   |
| –      | T4                                 | TP1<br>TP13   | F-A, S-B               | Category B<br>SW1<br>SW2<br>H2 | SGG2<br>SGG18<br>SG35 | See entry above.  | 2818   |
| –      | T4                                 | TP1           | F-A, S-B               | Category A                     | SGG1<br>SG36<br>SG49  | Clear colourless liquid. A mixture of primary and amyl isomers. Immiscible with water. Corrosive to skin, eyes and mucous membranes.  | 2819   |
| –      | T4                                 | TP1           | F-A, S-B               | Category A<br>SW1<br>H2        | SGG1<br>SG36<br>SG49  | Colourless liquid with a penetrating and unpleasant odour. Freezing point: –5°C to –8°C. Miscible with water. Corrosive to most metals. Harmful if swallowed or by inhalation. Corrosive to skin, eyes and mucous membranes.  | 2820   |
| –      | T7                                 | TP2           | F-A, S-A               | Category A                     | –                     | Yellowish solutions with a perceptible odour. Toxic if swallowed, by skin contact or by inhalation. Rapidly absorbed through the skin.  | 2821   |
| –      | T4                                 | TP1           | F-A, S-A               | Category A                     | –                     | See entry above.  | 2821   |
| –      | T7                                 | TP2           | F-A, S-A               | Category A<br>SW2              | –                     | Colourless oily liquid. Slightly miscible with water. Toxic if swallowed, by skin contact or by inhalation.   | 2822   |
| –      | T1                                 | TP33          | F-A, S-B               | Category A<br>SW1<br>H2        | SGG1<br>SG36<br>SG49  | White crystalline solid. Soluble in water. Decomposes when heated, evolving toxic fumes. Causes burns to skin, eyes and mucous membranes.   | 2823   |
| –      | T7                                 | TP2           | F-E, S-C               | Category A<br>SW2              | SGG1<br>SG36<br>SG49  | Colourless, flammable liquid. Flashpoint: 29°C c.c. Causes burns to skin, eyes and mucous membranes.  | 2826   |
| –      | T4                                 | TP1           | F-A, S-B               | Category A                     | SGG1<br>SG36<br>SG49  | Oily, colourless or yellowish liquid. Melting point: –4°C. Partially miscible with water. Corrosive to mild steel. Causes burns to skin, eyes and mucous membranes.   | 2829   |
| –      | T3                                 | TP33          | F-G, S-N               | Category E<br>SW2<br>SW5<br>H1 | SG26                  | Dark, crystalline, metal-like powder or brittle lumps. In contact with moisture, evolves flammable and toxic gases.   | 2830   |
| –      | T4                                 | TP1           | F-A, S-A               | Category A<br>SW2              | SGG10                 | Colourless liquid. Immiscible with water. Decomposes when heated, evolving highly toxic fumes (phosgene and hydrogen chloride). Toxic if swallowed, by skin contact or by inhalation. Narcotic in high concentrations.  | 2831   |
| –      | T1                                 | TP33          | F-A, S-B               | Category A<br>SW1              | SGG1<br>SG36<br>SG49  | Colourless to yellow deliquescent crystals. Soluble in water. Mildly corrosive to most metals. Causes burns to skin, eyes and mucous membranes.   | 2834   |
| –      | T3                                 | TP33          | F-G, S-O               | Category E<br>H1               | SG26<br>SG35          | White, crystalline solid. Reacts with water, moisture or acids, evolving hydrogen, which may be ignited by the heat of the reaction.  | 2835   |
| –      | T7                                 | TP2           | F-A, S-B               | Category A                     | –                     | Colourless to white liquid. Miscible with water. Corrosive to most metals. Causes burns to skin, eyes and mucous membranes.   | 2837   |
| –      | T4                                 | TP1           | F-A, S-B               | Category A                     | –                     | See entry above.  | 2837   |
| –      | T4                                 | TP1           | F-E, S-D               | Category C<br>SW1              | –                     | Colourless liquid with a pungent odour. Flashpoint: 12°C c.c. Explosive limits: 1.4% to 8.8%. Immiscible with water. Irritating to skin, eyes and mucous membranes.   | 2838   |
| –      | T7                                 | TP2           | F-A, S-A               | Category A<br>SW1<br>H2        | –                     | Clear, colourless to yellow viscous liquid. Miscible with water. Decomposes at 85°C, evolving toxic fumes. May react vigorously with oxidizing substances. Toxic if swallowed, by skin contact or by inhalation.  | 2839   |

Part 3 – Dangerous Goods List, special provisions and exceptions

Chapter 3.2 – Dangerous Goods List

| UN No. | Proper shipping name (PSN)   | Class or division | Subsidiary hazard(s) | Packing group  | Special provisions | Limited and excepted quantity provisions |                     | Packing      |              | IBC           |               |
|--------|--|-------------------|----------------------|----------------|--------------------|--|---------------------|--------------|--------------|---------------|---------------|
|        |  |                   |                      |                |                    | Limited quantities                       | Excepted quantities | Instructions | Provisions   | Instructions  | Provisions    |
| (1)    | (2)<br>3.1.2   | (3)<br>2.0        | (4)<br>2.0           | (5)<br>2.0.1.3 | (6)<br>3.3         | (7a)<br>3.4                              | (7b)<br>3.5         | (8)<br>4.1.4 | (9)<br>4.1.4 | (10)<br>4.1.4 | (11)<br>4.1.4 |
| 2840   | BUTYRALDOXIME  | 3                 | –                    | III            | –                  | 5 L                                      | E1                  | P001<br>LP01 | –            | IBC03         | –             |
| 2841   | DI- <i>n</i> -AMYLAMINE  | 3                 | 6.1                  | III            | –                  | 5 L                                      | E1                  | P001         | –            | IBC03         | –             |
| 2842   | NITROETHANE  | 3                 | –                    | III            | –                  | 5 L                                      | E1                  | P001<br>LP01 | –            | IBC03         | –             |
| 2844   | CALCIUM MANGANESE SILICON  | 4.3               | –                    | III            | –                  | 1 kg                                     | E1                  | P410         | PP31         | IBC08         | B4            |
| 2845   | PYROPHORIC LIQUID, ORGANIC, N.O.S.   | 4.2               | –                    | I              | 274                | 0  | E0                  | P400         | –            | –             | –             |
| 2846   | PYROPHORIC SOLID, ORGANIC, N.O.S.  | 4.2               | –                    | I              | 274                | 0  | E0                  | P404         | PP31         | –             | –             |
| 2849   | 3-CHLOROPROPANOL-1   | 6.1               | –                    | III            | –                  | 5 L                                      | E1                  | P001<br>LP01 | –            | IBC03         | –             |
| 2850   | PROPYLENE TETRAMER   | 3                 | –<br>P               | III            | –                  | 5 L                                      | E1                  | P001<br>LP01 | –            | IBC03         | –             |
| 2851   | BORON TRIFLUORIDE DIHYDRATE  | 8                 | –                    | II             | –                  | 1 L                                      | E2                  | P001         | –            | IBC02         | –             |
| 2852   | DIPICRYL SULPHIDE, WETTED with not less than 10% water, by mass  | 4.1               | –                    | I              | 28                 | 0  | E0                  | P406         | PP24<br>PP31 | –             | –             |
| 2853   | MAGNESIUM FLUOROSILICATE   | 6.1               | –                    | III            | –                  | 5 kg                                     | E1                  | P002<br>LP02 | –            | IBC08         | B3            |
| 2854   | AMMONIUM FLUOROSILICATE  | 6.1               | –                    | III            | –                  | 5 kg                                     | E1                  | P002<br>LP02 | –            | IBC08         | B3            |
| 2855   | ZINC FLUOROSILICATE  | 6.1               | –                    | III            | –                  | 5 kg                                     | E1                  | P002<br>LP02 | –            | IBC08         | B3            |
| 2856   | FLUOROSILICATES, N.O.S.  | 6.1               | –                    | III            | 274                | 5 kg                                     | E1                  | P002<br>LP02 | –            | IBC08         | B3            |
| 2857   | REFRIGERATING MACHINES containing non-flammable, non-toxic, gases or ammonia solutions (UN 2672)                     | 2.2               | –                    | –              | 119                | 0  | E0                  | P003         | PP32         | –             | –             |
| 2858   | ZIRCONIUM, DRY, coiled wire, finished metal sheets, strip (thinner than 254 microns but not thinner than 18 microns) | 4.1               | –                    | III            | 921                | 5 kg                                     | E1                  | P002<br>LP02 | PP100<br>L3  | –             | –             |
| 2859   | AMMONIUM METAVANADATE  | 6.1               | –                    | II             | –                  | 500 g                                    | E4                  | P002         | –            | IBC08         | B4<br>B21     |

| UN No. | Portable tanks and bulk containers |               | EmS                    | Stowage and handling           | Segregation                        | Properties and observations   | UN No. |
|--------|------------------------------------|---------------|------------------------|--------------------------------|------------------------------------|---|--------|
|        | Tank instructions                  | Provisions    |                        |                                |                                    |   |        |
| (12)   | (13)<br>4.2.5<br>4.3               | (14)<br>4.2.5 | (15)<br>5.4.3.4<br>7.8 | (16a)<br>7.1<br>7.3–7.7        | (16b)<br>7.2–7.7                   | (17)  | (18)   |
| –      | T2                                 | TP1           | F-E, S-D               | Category A                     | –                                  | Colourless liquid. Immiscible with water. Flashpoint: 58°C c.c. Harmful by inhalation. Irritating to skin, eyes and mucous membranes.   | 2840   |
| –      | T4                                 | TP1           | F-E, S-D               | Category A                     | SG35                               | Colourless liquid with an ammoniacal odour. Flashpoint: 52°C c.c. Slightly miscible with water. Toxic if swallowed, by skin contact or by inhalation.   | 2841   |
| –      | T2                                 | TP1           | F-E, S-D               | Category A                     | –                                  | Colourless, oily liquid. Flashpoint: 28°C c.c. Lower explosive limit: 3.4%. When involved in a fire, evolves nitrous toxic fumes. Slightly soluble in water. Irritating to skin, eyes and mucous membranes. | 2842   |
| –      | T1                                 | TP33          | F-G, S-N               | Category A<br>SW5<br>H1        | SG26<br>SG35                       | In contact with water, evolves hydrogen, a flammable gas. In contact with acid, evolves silane, a spontaneously flammable gas.  | 2844   |
| –      | T22                                | TP2<br>TP7    | F-G, S-M               | Category D<br>H1               | SG26<br>SG63                       | Highly flammable liquids, may ignite spontaneously in moist air. In contact with air, evolve irritating and slightly toxic fumes.   | 2845   |
| –      | –                                  | –             | F-G, S-M               | Category D<br>H1               | SG26                               | Liable to ignite spontaneously in air. If shaken, may produce sparks. In contact with water, evolve hydrogen, a flammable gas.  | 2846   |
| –      | T4                                 | TP1           | F-A, S-A               | Category A                     | –                                  | Colourless to light-yellow liquid. Miscible with water. Mildly corrosive to steel. Toxic if swallowed, by skin contact or by inhalation.  | 2849   |
| –      | T2                                 | TP2           | F-E, S-E               | Category A                     | –                                  | Colourless liquid. Immiscible with water. Irritating to skin, eyes and mucous membranes. 1-dodecene is not marine pollutant.  | 2850   |
| –      | T7                                 | TP2           | F-A, S-B               | Category B<br>SW1<br>SW2<br>H2 | SGG1<br>SG36<br>SG49               | Colourless, non-fuming liquid. Boiling range: 58°C to 60°C. Reacts with water, evolving corrosive and toxic fumes. Corrosive to mild steel. Causes burns to skin, eyes and mucous membranes.                | 2851   |
| –      | –                                  | –             | F-B, S-J               | Category D                     | SG7<br>SG30                        | Desensitized explosive. Golden-yellow, crystalline leaflets. Explosive and sensitive to shock and heat in the dry state. May form extremely sensitive compounds with heavy metals or their salts.           | 2852   |
| –      | T1                                 | TP33          | F-A, S-A               | Category A                     | SG35                               | Solids which react with acids, evolving hydrogen fluoride and silicon tetrafluoride, irritating and corrosive gases. Toxic if swallowed, by skin contact or by dust inhalation.                             | 2853   |
| –      | T1                                 | TP33          | F-A, S-A               | Category A                     | SGG2<br>SG35                       | Solids which react with acids, evolving hydrogen fluoride and silicon tetrafluoride, irritating and corrosive gases. Toxic if swallowed, by skin contact or by dust inhalation.                             | 2854   |
| –      | T1                                 | TP33          | F-A, S-A               | Category A                     | SGG7<br>SG35                       | Solids which react with acids, evolving hydrogen fluoride and silicon tetrafluoride, irritating and corrosive gases. Toxic if swallowed, by skin contact or by dust inhalation.                             | 2855   |
| –      | T1                                 | TP33          | F-A, S-A               | Category A                     | SG35                               | Solids which react with acids, evolving hydrogen fluoride and silicon tetrafluoride, irritating and corrosive gases. Toxic if swallowed, by skin contact or by dust inhalation.                             | 2856   |
| –      | –                                  | –             | F-C, S-V               | Category A                     | –                                  | –   | 2857   |
| –      | –                                  | –             | F-G, S-G               | Category A<br>H1               | SG25<br>SG26                       | Hard silvery metal.   | 2858   |
| –      | T3                                 | TP33          | F-A, S-A               | Category A                     | SGG2<br>SG6<br>SG8<br>SG10<br>SG12 | White crystalline powder. Slightly soluble in water. May act as an oxidizing substance. Toxic if swallowed, by skin contact or by inhalation.   | 2859   |

Part 3 – Dangerous Goods List, special provisions and exceptions

Chapter 3.2 – Dangerous Goods List

| UN No. | Proper shipping name (PSN)                          | Class or division | Subsidiary hazard(s) | Packing group  | Special provisions | Limited and excepted quantity provisions |                     | Packing      |              | IBC           |               |
|--------|---|-------------------|----------------------|----------------|--------------------|--|---------------------|--------------|--------------|---------------|---------------|
|        |   |                   |                      |                |                    | Limited quantities                       | Excepted quantities | Instructions | Provisions   | Instructions  | Provisions    |
| (1)    | (2)<br>3.1.2  | (3)<br>2.0        | (4)<br>2.0           | (5)<br>2.0.1.3 | (6)<br>3.3         | (7a)<br>3.4                              | (7b)<br>3.5         | (8)<br>4.1.4 | (9)<br>4.1.4 | (10)<br>4.1.4 | (11)<br>4.1.4 |
| 2861   | AMMONIUM POLYVANADATE                               | 6.1               | –                    | II             | –                  | 500 g                                    | E4                  | P002         | –            | IBC08         | B4<br>B21     |
| 2862   | VANADIUM PENTOXIDE, non-fused form                  | 6.1               | –                    | III            | –                  | 5 kg                                     | E1                  | P002<br>LP02 | –            | IBC08         | B3            |
| 2863   | SODIUM AMMONIUM VANADATE                            | 6.1               | –                    | II             | –                  | 500 g                                    | E4                  | P002         | –            | IBC08         | B4<br>B21     |
| 2864   | POTASSIUM METAVANADATE                              | 6.1               | –                    | II             | –                  | 500 g                                    | E4                  | P002         | –            | IBC08         | B4<br>B21     |
| 2865   | HYDROXYLAMINE SULPHATE                              | 8                 | –                    | III            | –                  | 5 kg                                     | E1                  | P002<br>LP02 | –            | IBC08         | B3            |
| 2869   | TITANIUM TRICHLORIDE MIXTURE                        | 8                 | –                    | II             | –                  | 1 kg                                     | E2                  | P002         | –            | IBC08         | B4<br>B21     |
| 2869   | TITANIUM TRICHLORIDE MIXTURE                        | 8                 | –                    | III            | 223                | 5 kg                                     | E1                  | P002<br>LP02 | –            | IBC08         | B3            |
| 2870   | ALUMINIUM BOROHYDRIDE                               | 4.2               | 4.3                  | I              | –                  | 0  | E0                  | P400         | –            | –             | –             |
| △ 2870 | ALUMINIUM BOROHYDRIDE IN DEVICES                    | 4.2               | 4.3                  | –              | –                  | 0  | E0                  | P002         | PP13         | –             | –             |
| 2871   | ANTIMONY POWDER                                     | 6.1               | –                    | III            | –                  | 5 kg                                     | E1                  | P002<br>LP02 | –            | IBC08         | B3            |
| 2872   | DIBROMOCHLOROPROPANES                               | 6.1               | –                    | II             | –                  | 100 mL                                   | E4                  | P001         | –            | IBC02         | –             |
| 2872   | DIBROMOCHLOROPROPANES                               | 6.1               | –                    | III            | 223                | 5 L                                      | E1                  | P001<br>LP01 | –            | IBC03         | –             |
| 2873   | DIBUTYLAMINOETHANOL                                 | 6.1               | –                    | III            | –                  | 5 L                                      | E1                  | P001<br>LP01 | –            | IBC03         | –             |
| 2874   | FURFURYL ALCOHOL                                    | 6.1               | –                    | III            | –                  | 5 L                                      | E1                  | P001<br>LP01 | –            | IBC03         | –             |
| 2875   | HEXACHLOROPHENE                                     | 6.1               | –                    | III            | –                  | 5 kg                                     | E1                  | P002<br>LP02 | –            | IBC08         | B3            |
| 2876   | RESORCINOL  | 6.1               | –                    | III            | –                  | 5 kg                                     | E1                  | P002<br>LP02 | –            | IBC08         | B3            |
| 2878   | TITANIUM SPONGE GRANULES or TITANIUM SPONGE POWDERS | 4.1               | –                    | III            | 223                | 5 kg                                     | E1                  | P002<br>LP02 | PP100<br>L3  | IBC08         | B4            |
| 2879   | SELENIUM OXYCHLORIDE                                | 8                 | 6.1                  | I              | –                  | 0  | E0                  | P001         | –            | –             | –             |

| UN No. | Portable tanks and bulk containers |               | EmS                    | Stowage and handling    | Segregation                           | Properties and observations   | UN No. |
|--------|------------------------------------|---------------|------------------------|-------------------------|---------------------------------------|---|--------|
|        | Tank instructions                  | Provisions    |                        |                         |                                       |   |        |
| (12)   | (13)<br>4.2.5<br>4.3               | (14)<br>4.2.5 | (15)<br>5.4.3.4<br>7.8 | (16a)<br>7.1<br>7.3–7.7 | (16b)<br>7.2–7.7                      | (17)  | (18)   |
| –      | T3                                 | TP33          | F-A, S-A               | Category A              | SGG2<br>SG6<br>SG8<br>SG10<br>SG12    | Orange powder. Slightly soluble in water. May act as an oxidizing substance. Toxic if swallowed, by skin contact or by inhalation.  | 2861   |
| –      | T1                                 | TP33          | F-A, S-A               | Category A              | –                                     | Brownish powder. Slightly soluble in water. Toxic if swallowed, by skin contact or by inhalation.   | 2862   |
| –      | T3                                 | TP33          | F-A, S-A               | Category A              | SGG2                                  | Orange wet cake (with 10% to 15% water). Soluble in water. Toxic if swallowed, by skin contact or by dust inhalation.   | 2863   |
| –      | T3                                 | TP33          | F-A, S-A               | Category A              | –                                     | White crystalline powder. Slightly soluble in water. Toxic if swallowed, by skin contact or by inhalation.  | 2864   |
| –      | T1                                 | TP33          | F-A, S-B               | Category A              | SGG1<br>SG35<br>SG36<br>SG49          | Colourless to white crystalline powder. Soluble in water. May decompose explosively when heated. Causes burns to skin, eyes and mucous membranes.   | 2865   |
| –      | T3                                 | TP33          | F-A, S-B               | Category A<br>SW2       | SGG1<br>SGG7<br>SG36<br>SG49          | Violet crystalline solid. Reacts in moist air or in water, evolving heat and hydrogen chloride, an irritating and corrosive gas apparent as white fumes. In the presence of moisture, corrosive to most metals. Causes burns to skin, eyes and mucous membranes.  | 2869   |
| –      | T1                                 | TP33          | F-A, S-B               | Category A<br>SW2       | SGG1<br>SGG7<br>SG36<br>SG49          | See entry above.  | 2869   |
| –      | T21                                | TP7<br>TP33   | F-G, S-M               | Category D<br>H1        | SG26                                  | Liquid. Ignites spontaneously in air. Reacts with water or steam to produce heat or hydrogen, which may form explosive mixtures with air.   | 2870   |
| –      | –                                  | –             | F-G, S-M               | Category D<br>H1        | SG26                                  | –   | 2870   |
| –      | T1                                 | TP33          | F-A, S-A               | Category A              | –                                     | Metallic antimony in the form of a fine grey powder. Insoluble in water. Toxic if swallowed, by skin contact or by dust inhalation.   | 2871   |
| –      | T7                                 | TP2           | F-A, S-A               | Category A              | SGG10                                 | Colourless liquid with a perceptible odour. Immiscible with water. Toxic if swallowed, by skin contact or by inhalation.  | 2872   |
| –      | T4                                 | TP1           | F-A, S-A               | Category A              | SGG10                                 | See entry above.  | 2872   |
| –      | T4                                 | TP1           | F-A, S-A               | Category A              | –                                     | Colourless liquid with a perceptible odour. Miscible with water. Toxic if swallowed, by skin contact or by inhalation.  | 2873   |
| –      | T4                                 | TP1           | F-A, S-A               | Category A              | SG17<br>SG35                          | Clear, colourless, mobile liquid, becoming brown to dark-red upon exposure to light and air. Miscible with water. Reacts explosively with oxidizing substances. Toxic if swallowed, by skin contact or by inhalation.   | 2874   |
| –      | T1                                 | TP33          | F-A, S-A               | Category A              | –                                     | White, odourless powder or crystals. Insoluble in water. Toxic if swallowed, by skin contact or by dust inhalation.   | 2875   |
| –      | T1                                 | TP33          | F-A, S-A               | Category A              | –                                     | White to pink crystals. Soluble in water. Toxic if swallowed, by skin contact or by dust inhalation.  | 2876   |
| –      | T1                                 | TP33          | F-G, S-G               | Category D<br>H1        | SGG7<br>SGG15<br>SG17<br>SG25<br>SG26 | Silvery grey granules or dark grey, amorphous powder. May react with carbon dioxide, evolving oxygen. Forms explosive mixtures with oxidizing substances.   | 2878   |
| –      | T10                                | TP2<br>TP13   | F-A, S-B               | Category E<br>SW2       | SGG1<br>SG36<br>SG49                  | Colourless, yellowish liquid. Reacts violently with water, evolving hydrogen chloride, an irritating and corrosive gas apparent as white fumes. In the presence of moisture, highly corrosive to most metals. Toxic if swallowed, by skin contact or by inhalation. Causes severe burns to skin, eyes and mucous membranes. | 2879   |

Part 3 – Dangerous Goods List, special provisions and exceptions

Chapter 3.2 – Dangerous Goods List

| UN No. | Proper shipping name (PSN)   | Class or division | Subsidiary hazard(s) | Packing group  | Special provisions | Limited and excepted quantity provisions |                     | Packing      |              | IBC           |               |
|--------|--|-------------------|----------------------|----------------|--------------------|--|---------------------|--------------|--------------|---------------|---------------|
|        |  |                   |                      |                |                    | Limited quantities                       | Excepted quantities | Instructions | Provisions   | Instructions  | Provisions    |
| (1)    | (2)<br>3.1.2   | (3)<br>2.0        | (4)<br>2.0           | (5)<br>2.0.1.3 | (6)<br>3.3         | (7a)<br>3.4                              | (7b)<br>3.5         | (8)<br>4.1.4 | (9)<br>4.1.4 | (10)<br>4.1.4 | (11)<br>4.1.4 |
| 2880   | CALCIUM HYPOCHLORITE, HYDRATED or CALCIUM HYPOCHLORITE, HYDRATED MIXTURE with not less than 5.5% but not more than 16% water | 5.1               | –<br>P               | II             | 314<br>322         | 1 kg                                     | E2                  | P002         | PP85         | –             | –             |
| 2880   | CALCIUM HYPOCHLORITE, HYDRATED or CALCIUM HYPOCHLORITE, HYDRATED MIXTURE with not less than 5.5% but not more than 16% water | 5.1               | –<br>P               | III            | 223<br>314         | 5 kg                                     | E1                  | P002         | PP85         | –             | –             |
| 2881   | METAL CATALYST, DRY  | 4.2               | –                    | I              | 274                | 0  | E0                  | P404         | PP31         | –             | –             |
| 2881   | METAL CATALYST, DRY  | 4.2               | –                    | II             | 274                | 0  | E0                  | P410         | PP31         | IBC06         | B21           |
| 2881   | METAL CATALYST, DRY  | 4.2               | –                    | III            | 223<br>274         | 0  | E1                  | P002<br>LP02 | PP31<br>L4   | IBC08         | B4            |
| 2900   | INFECTIOUS SUBSTANCE, AFFECTING ANIMALS only   | 6.2               | –                    | –              | 318<br>341         | 0  | E0                  | P620         | –            | –             | –             |
| 2901   | BROMINE CHLORIDE   | 2.3               | 5.1/8                | –              | –                  | 0  | E0                  | P200         | –            | –             | –             |
| 2902   | PESTICIDE, LIQUID, TOXIC, N.O.S.   | 6.1               | –                    | I              | 61<br>274          | 0  | E5                  | P001         | –            | –             | –             |
| 2902   | PESTICIDE, LIQUID, TOXIC, N.O.S.   | 6.1               | –                    | II             | 61<br>274          | 100 mL                                   | E4                  | P001         | –            | IBC02         | –             |
| 2902   | PESTICIDE, LIQUID, TOXIC, N.O.S.   | 6.1               | –                    | III            | 61<br>223<br>274   | 5 L                                      | E1                  | P001<br>LP01 | –            | IBC03         | –             |
| 2903   | PESTICIDE, LIQUID, TOXIC, FLAMMABLE, N.O.S. flashpoint not less than 23°C  | 6.1               | 3                    | I              | 61<br>274          | 0  | E5                  | P001         | –            | –             | –             |
| 2903   | PESTICIDE, LIQUID, TOXIC, FLAMMABLE, N.O.S. flashpoint not less than 23°C  | 6.1               | 3                    | II             | 61<br>274          | 100 mL                                   | E4                  | P001         | –            | IBC02         | –             |
| 2903   | PESTICIDE, LIQUID, TOXIC, FLAMMABLE, N.O.S. flashpoint not less than 23°C  | 6.1               | 3                    | III            | 61<br>223<br>274   | 5 L                                      | E1                  | P001         | –            | IBC03         | –             |

| UN No. | Portable tanks and bulk containers |                     | EmS                    | Stowage and handling          | Segregation                                  | Properties and observations   | UN No. |
|--------|------------------------------------|---------------------|------------------------|-------------------------------|--|---|--------|
|        | Tank instructions                  | Provisions          |                        |                               |  |   |        |
| (12)   | (13)<br>4.2.5<br>4.3               | (14)<br>4.2.5       | (15)<br>5.4.3.4<br>7.8 | (16a)<br>7.1<br>7.3–7.7       | (16b)<br>7.2–7.7                             | (17)  | (18)   |
| –      | –                                  | –                   | F-H, S-Q               | Category D<br>SW1<br>SW11     | SGG8<br>SG35<br>SG38<br>SG49<br>SG53<br>SG60 | White or yellowish solid (powder, granules or tablets) with chlorine-like odour. Soluble in water. May cause fire in contact with organic material or ammonium compounds. Substances are liable to exothermic decomposition at elevated temperatures. This condition may lead to fire or explosion. Decomposition can be initiated by heat or by impurities (e.g. powdered metals (iron, manganese, cobalt, magnesium) and their compounds). Liable to heat slowly. Reacts with acids, evolving chlorine, an irritating, corrosive and toxic gas. In the presence of moisture, corrosive to most metals. Dust irritates mucous membranes. | 2880   |
| –      | –                                  | –                   | F-H, S-Q               | Category D<br>SW1<br>SW11     | SGG8<br>SG35<br>SG38<br>SG49<br>SG53<br>SG60 | See entry above   | 2880   |
| –      | T21                                | TP7<br>TP33         | F-G, S-M               | Category C<br>H1              | SGG7<br>SGG15<br>SG25<br>SG26                | Liable to ignite spontaneously in air.  | 2881   |
| –      | T3                                 | TP33                | F-G, S-M               | Category C<br>H1              | SGG7<br>SGG15<br>SG25<br>SG26                | See entry above.  | 2881   |
| –      | T1                                 | TP33                | F-G, S-M               | Category C<br>H1              | SGG7<br>SGG15<br>SG25<br>SG26                | See entry above.  | 2881   |
| –      | BK2                                | –                   | F-A, S-T               | Category E<br>SW2<br>H1<br>H5 | SG50   | Substances which are dangerous to animals only. For action to be taken in the event of damage to, or leaking from, a package containing infectious substances, refer to 7.8.3.  | 2900   |
| –      | –                                  | –                   | F-C, S-W               | Category D<br>SW2             | SG6<br>SG19                                  | Reddish-yellow non-flammable, toxic and corrosive gas. When heated to decomposition, emits highly toxic and corrosive fumes of bromine and chlorine. Reacts with water, evolving toxic and corrosive fumes. Powerful oxidizing agent which may cause violent fires with combustible materials. Much heavier than air. Highly irritating to skin, eyes and mucous membranes.   | 2901   |
| –      | T14                                | TP2<br>TP13<br>TP27 | F-A, S-A               | Category B<br>SW2             | –  | Liquid pesticides which present a very wide range of toxic hazard. Miscibility with water depends upon the composition. Toxic if swallowed, by skin contact or by inhalation.   | 2902   |
| –      | T11                                | TP2<br>TP13<br>TP27 | F-A, S-A               | Category B<br>SW2             | –  | See entry above.  | 2902   |
| –      | T7                                 | TP2<br>TP28         | F-A, S-A               | Category A<br>SW2             | –  | See entry above.  | 2902   |
| –      | T14                                | TP2<br>TP13<br>TP27 | F-E, S-D               | Category B<br>SW2             | –  | Liquid flammable pesticides having a flashpoint between 23°C and 60°C c.c., presenting a very wide range of toxic hazard. They frequently contain petroleum or coal tar distillates, or other flammable liquids. Flashpoint and miscibility with water depend upon the composition. Toxic if swallowed, by skin contact or by inhalation.   | 2903   |
| –      | T11                                | TP2<br>TP13<br>TP27 | F-E, S-D               | Category B<br>SW2             | –  | See entry above.  | 2903   |
| –      | T7                                 | TP2                 | F-E, S-D               | Category A<br>SW2             | –  | See entry above.  | 2903   |



Part 3 – Dangerous Goods List, special provisions and exceptions

Chapter 3.2 – Dangerous Goods List

| UN No. | Proper shipping name (PSN)   | Class or division | Subsidiary hazard(s) | Packing group  | Special provisions | Limited and excepted quantity provisions |                     | Packing      |              | IBC           |               |
|--------|--|-------------------|----------------------|----------------|--------------------|--|---------------------|--------------|--------------|---------------|---------------|
|        |  |                   |                      |                |                    | Limited quantities                       | Excepted quantities | Instructions | Provisions   | Instructions  | Provisions    |
| (1)    | (2)<br>3.1.2   | (3)<br>2.0        | (4)<br>2.0           | (5)<br>2.0.1.3 | (6)<br>3.3         | (7a)<br>3.4                              | (7b)<br>3.5         | (8)<br>4.1.4 | (9)<br>4.1.4 | (10)<br>4.1.4 | (11)<br>4.1.4 |
| 2904   | CHLOROPHENOLATES, LIQUID or PHENOLATES, LIQUID   | 8                 | –                    | III            | –                  | 5 L                                      | E1                  | P001 LP01    | –            | IBC03         | –             |
| 2905   | CHLOROPHENOLATES, SOLID or PHENOLATES, SOLID   | 8                 | –                    | III            | –                  | 5 kg                                     | E1                  | P002 LP02    | –            | IBC08         | B3            |
| 2907   | ISOSORBIDE DINITRATE MIXTURE with not less than 60% lactose, mannose, starch, or calcium hydrogen phosphate                | 4.1               | –                    | II             | 28<br>127          | 0  | E0                  | P406         | PP26<br>PP80 | IBC06         | B12<br>B21    |
| 2908   | RADIOACTIVE MATERIAL, EXCEPTED PACKAGE – EMPTY PACKAGING   | 7                 | See SP290            | –              | 290<br>368         | 0  | E0                  | See 4.1.9    | See 4.1.9    | See 4.1.9     | See 4.1.9     |
| 2909   | RADIOACTIVE MATERIAL, EXCEPTED PACKAGE – ARTICLES MANUFACTURED FROM NATURAL URANIUM or DEPLETED URANIUM or NATURAL THORIUM | 7                 | See SP290            | –              | 290                | 0  | E0                  | See 4.1.9    | See 4.1.9    | See 4.1.9     | See 4.1.9     |
| 2910   | RADIOACTIVE MATERIAL, EXCEPTED PACKAGE – LIMITED QUANTITY OF MATERIAL  | 7                 | See SP290            | –              | 290<br>368         | 0  | E0                  | See 4.1.9    | See 4.1.9    | See 4.1.9     | See 4.1.9     |
| 2911   | RADIOACTIVE MATERIAL, EXCEPTED PACKAGE – INSTRUMENTS or ARTICLES   | 7                 | See SP290            | –              | 290                | 0  | E0                  | See 4.1.9    | See 4.1.9    | See 4.1.9     | See 4.1.9     |
| 2912   | RADIOACTIVE MATERIAL, LOW SPECIFIC ACTIVITY (LSA-I), non fissile or fissile-excepted                                       | 7                 | See SP172            | –              | 172<br>317<br>325  | 0  | E0                  | See 4.1.9    | See 4.1.9    | See 4.1.9     | See 4.1.9     |
| 2913   | RADIOACTIVE MATERIAL, SURFACE CONTAMINATED OBJECTS (SCO-I, SCO-II or SCO-III), non fissile or fissile-excepted             | 7                 | See SP172            | –              | 172<br>317<br>325  | 0  | E0                  | See 4.1.9    | See 4.1.9    | See 4.1.9     | See 4.1.9     |
| 2915   | RADIOACTIVE MATERIAL, TYPE A PACKAGE, non-special form, non fissile or fissile-excepted                                    | 7                 | See SP172            | –              | 172<br>317<br>325  | 0  | E0                  | See 4.1.9    | See 4.1.9    | See 4.1.9     | See 4.1.9     |
| 2916   | RADIOACTIVE MATERIAL, TYPE B(U) PACKAGE, non fissile or fissile-excepted   | 7                 | See SP172            | –              | 172<br>317<br>325  | 0  | E0                  | See 4.1.9    | See 4.1.9    | See 4.1.9     | See 4.1.9     |
| 2917   | RADIOACTIVE MATERIAL, TYPE B(M) PACKAGE, non fissile or fissile-excepted   | 7                 | See SP172            | –              | 172<br>317<br>325  | 0  | E0                  | See 4.1.9    | See 4.1.9    | See 4.1.9     | See 4.1.9     |
| 2919   | RADIOACTIVE MATERIAL TRANSPORTED UNDER SPECIAL ARRANGEMENT, non fissile or fissile-excepted                                | 7                 | See SP172            | –              | 172<br>317<br>325  | 0  | E0                  | See 4.1.9    | See 4.1.9    | See 4.1.9     | See 4.1.9     |
| 2920   | CORROSIVE LIQUID, FLAMMABLE, N.O.S.  | 8                 | 3                    | I              | 274                | 0  | E0                  | P001         | –            | –             | –             |
| 2920   | CORROSIVE LIQUID, FLAMMABLE, N.O.S.  | 8                 | 3                    | II             | 274                | 1 L                                      | E2                  | P001         | –            | IBC02         | –             |
| 2921   | CORROSIVE SOLID, FLAMMABLE, N.O.S.   | 8                 | 4.1                  | I              | 274                | 0  | E0                  | P002         | –            | IBC99         | –             |
| 2921   | CORROSIVE SOLID, FLAMMABLE, N.O.S.   | 8                 | 4.1                  | II             | 274                | 1 kg                                     | E2                  | P002         | –            | IBC08         | B4<br>B21     |

| UN No. | Portable tanks and bulk containers |               | EmS                    | Stowage and handling       | Segregation      | Properties and observations   | UN No. |
|--------|------------------------------------|---------------|------------------------|----------------------------|------------------|---|--------|
|        | Tank instructions                  | Provisions    |                        |                            |                  |   |        |
| (12)   | (13)<br>4.2.5<br>4.3               | (14)<br>4.2.5 | (15)<br>5.4.3.4<br>7.8 | (16a)<br>7.1<br>7.3–7.7    | (16b)<br>7.2–7.7 | (17)  | (18)   |
| –      | –                                  | –             | F-A, S-B               | Category A                 | –                | A wide range of corrosive liquids. Cause burns to skin, eyes and mucous membranes.  | 2904   |
| –      | T1                                 | TP33          | F-A, S-B               | Category A                 | –                | A wide range of corrosive solids. Soluble in water. Cause burns to skin, eyes and mucous membranes.   | 2905   |
| –      | –                                  | –             | F-A, S-J               | Category E                 | SG7<br>SG30      | Desensitized explosive. Pure isosorbide dinitrate is explosive. May form extremely sensitive compounds with heavy metals or their salts.              | 2907   |
| –      | –                                  | –             | F-I, S-S               | Category A                 | –                | See 1.5.1 and 5.1.5.4.2.  | 2908   |
| –      | –                                  | –             | F-I, S-S               | Category A                 | –                | See 1.5.1 and 5.1.5.4.2.  | 2909   |
| –      | –                                  | –             | F-I, S-S               | Category A                 | –                | See 1.5.1 and 5.1.5.4.2.  | 2910   |
| –      | –                                  | –             | F-I, S-S               | Category A                 | –                | See 1.5.1 and 5.1.5.4.2.  | 2911   |
| –      | T5                                 | TP4           | F-I, S-S               | Category A<br>SW20<br>SW21 | –                | See 1.5.1.  | 2912   |
| –      | T5                                 | TP4           | F-I, S-S               | Category A                 | –                | See 1.5.1.  | 2913   |
| –      | –                                  | –             | F-I, S-S               | Category A<br>SW20<br>SW21 | –                | See 1.5.1.  | 2915   |
| –      | –                                  | –             | F-I, S-S               | Category A<br>SW12         | –                | See 1.5.1. For ships transporting an INF cargo as defined in regulation VII/14 of the SOLAS Convention, 1974, as amended, refer also to the INF Code. | 2916   |
| –      | –                                  | –             | F-I, S-S               | Category A<br>SW12         | –                | See 1.5.1. For ships transporting an INF cargo as defined in regulation VII/14 of the SOLAS Convention, 1974, as amended, refer also to the INF Code. | 2917   |
| –      | –                                  | –             | F-I, S-S               | Category A<br>SW13         | –                | See 1.5.1. For ships transporting an INF cargo as defined in regulation VII/14 of the SOLAS Convention, 1974, as amended, refer also to the INF Code. | 2919   |
| –      | T14                                | TP2<br>TP27   | F-E, S-C               | Category C<br>SW1<br>SW2   | –                | Causes burns to skin, eyes and mucous membranes.  | 2920   |
| –      | T11                                | TP2<br>TP27   | F-E, S-C               | Category C<br>SW1<br>SW2   | –                | See entry above.  | 2920   |
| –      | T6                                 | TP33          | F-A, S-G               | Category B<br>SW1<br>H2    | –                | Causes burns to skin, eyes and mucous membranes.  | 2921   |
| –      | T3                                 | TP33          | F-A, S-G               | Category B<br>SW1<br>H2    | –                | See entry above.  | 2921   |

Part 3 – Dangerous Goods List, special provisions and exceptions

Chapter 3.2 – Dangerous Goods List

| UN No. | Proper shipping name (PSN)                  | Class or division | Subsidiary hazard(s) | Packing group  | Special provisions | Limited and excepted quantity provisions |                          | Packing          |                | IBC               |                 |
|--------|---|-------------------|----------------------|----------------|--------------------|--|--------------------------|------------------|----------------|-------------------|-----------------|
|        |   |                   |                      |                |                    | Limited quantities (7a)                  | Excepted quantities (7b) | Instructions (8) | Provisions (9) | Instructions (10) | Provisions (11) |
| (1)    | (2)<br>3.1.2                                | (3)<br>2.0        | (4)<br>2.0           | (5)<br>2.0.1.3 | (6)<br>3.3         | (7a)<br>3.4                              | (7b)<br>3.5              | (8)<br>4.1.4     | (9)<br>4.1.4   | (10)<br>4.1.4     | (11)<br>4.1.4   |
| 2922   | CORROSIVE LIQUID, TOXIC, N.O.S.             | 8                 | 6.1                  | I              | 274                | 0  | E0                       | P001             | -              | -                 | -               |
| 2922   | CORROSIVE LIQUID, TOXIC, N.O.S.             | 8                 | 6.1                  | II             | 274                | 1 L                                      | E2                       | P001             | -              | IBC02             | -               |
| 2922   | CORROSIVE LIQUID, TOXIC, N.O.S.             | 8                 | 6.1                  | III            | 223<br>274         | 5 L                                      | E1                       | P001             | -              | IBC03             | -               |
| 2923   | CORROSIVE SOLID, TOXIC, N.O.S.              | 8                 | 6.1                  | I              | 274                | 0  | E0                       | P002             | -              | IBC99             | -               |
| 2923   | CORROSIVE SOLID, TOXIC, N.O.S.              | 8                 | 6.1                  | II             | 274                | 1 kg                                     | E2                       | P002             | -              | IBC08             | B4<br>B21       |
| 2923   | CORROSIVE SOLID, TOXIC, N.O.S.              | 8                 | 6.1                  | III            | 223<br>274         | 5 kg                                     | E1                       | P002             | -              | IBC08             | B3              |
| 2924   | FLAMMABLE LIQUID, CORROSIVE, N.O.S.         | 3                 | 8                    | I              | 274                | 0  | E0                       | P001             | -              | -                 | -               |
| 2924   | FLAMMABLE LIQUID, CORROSIVE, N.O.S.         | 3                 | 8                    | II             | 274                | 1 L                                      | E2                       | P001             | -              | IBC02             | -               |
| 2924   | FLAMMABLE LIQUID, CORROSIVE, N.O.S.         | 3                 | 8                    | III            | 223<br>274         | 5 L                                      | E1                       | P001             | -              | IBC03             | -               |
| 2925   | FLAMMABLE SOLID, CORROSIVE, ORGANIC, N.O.S. | 4.1               | 8                    | II             | 274                | 1 kg                                     | E2                       | P002             | -              | IBC06             | B21             |
| 2925   | FLAMMABLE SOLID, CORROSIVE, ORGANIC, N.O.S. | 4.1               | 8                    | III            | 223<br>274         | 5 kg                                     | E1                       | P002             | -              | IBC06             | -               |
| 2926   | FLAMMABLE SOLID, TOXIC, ORGANIC, N.O.S.     | 4.1               | 6.1                  | II             | 274                | 1 kg                                     | E2                       | P002             | -              | IBC06             | B21             |
| 2926   | FLAMMABLE SOLID, TOXIC, ORGANIC, N.O.S.     | 4.1               | 6.1                  | III            | 223<br>274         | 5 kg                                     | E1                       | P002             | -              | IBC06             | -               |
| 2927   | TOXIC LIQUID, CORROSIVE, ORGANIC, N.O.S.    | 6.1               | 8                    | I              | 274<br>315         | 0  | E5                       | P001             | -              | -                 | -               |
| 2927   | TOXIC LIQUID, CORROSIVE, ORGANIC, N.O.S.    | 6.1               | 8                    | II             | 274                | 100 mL                                   | E4                       | P001             | -              | IBC02             | -               |
| 2928   | TOXIC SOLID, CORROSIVE, ORGANIC, N.O.S.     | 6.1               | 8                    | I              | 274                | 0  | E5                       | P002             | -              | IBC99             | -               |
| 2928   | TOXIC SOLID, CORROSIVE, ORGANIC, N.O.S.     | 6.1               | 8                    | II             | 274                | 500 g                                    | E4                       | P002             | -              | IBC06             | B21             |
| 2929   | TOXIC LIQUID, FLAMMABLE, ORGANIC, N.O.S.    | 6.1               | 3                    | I              | 274<br>315         | 0  | E5                       | P001             | -              | -                 | -               |
| 2929   | TOXIC LIQUID, FLAMMABLE, ORGANIC, N.O.S.    | 6.1               | 3                    | II             | 274                | 100 mL                                   | E4                       | P001             | -              | IBC02             | -               |
| 2930   | TOXIC SOLID, FLAMMABLE, ORGANIC, N.O.S.     | 6.1               | 4.1                  | I              | 274                | 0  | E5                       | P002             | -              | IBC99             | -               |
| 2930   | TOXIC SOLID, FLAMMABLE, ORGANIC, N.O.S.     | 6.1               | 4.1                  | II             | 274                | 500 g                                    | E4                       | P002             | -              | IBC08             | B4<br>B21       |
| 2931   | VANADYL SULPHATE                            | 6.1               | -                    | II             | -                  | 500 g                                    | E4                       | P002             | -              | IBC08             | B4<br>B21       |
| 2933   | METHYL 2-CHLORO-PROPIONATE                  | 3                 | -                    | III            | -                  | 5 L                                      | E1                       | P001<br>LP01     | -              | IBC03             | -               |
| 2934   | ISOPROPYL 2-CHLORO-PROPIONATE               | 3                 | -                    | III            | -                  | 5 L                                      | E1                       | P001<br>LP01     | -              | IBC03             | -               |

| UN No. | Portable tanks and bulk containers |                     | EmS                    | Stowage and handling    | Segregation      | Properties and observations   | UN No. |
|--------|------------------------------------|---------------------|------------------------|-------------------------|------------------|---|--------|
|        | Tank instructions (12)             | Provisions (14)     |                        |                         |                  |   |        |
| (18)   | (13)<br>4.2.5<br>4.3               | (14)<br>4.2.5       | (15)<br>5.4.3.4<br>7.8 | (16a)<br>7.1<br>7.3-7.7 | (16b)<br>7.2-7.7 | (17)  | (18)   |
| 2922   | T14                                | TP2<br>TP13<br>TP27 | F-A, S-B               | Category B<br>SW2       | -                | Causes burns to skin, eyes and mucous membranes. Toxic if swallowed, by skin contact or by inhalation.                                      | 2922   |
| 2922   | T7                                 | TP2                 | F-A, S-B               | Category B<br>SW2       | -                | See entry above.  | 2922   |
| 2922   | T7                                 | TP1<br>TP28         | F-A, S-B               | Category B<br>SW2       | -                | See entry above.  | 2922   |
| 2923   | T6                                 | TP33                | F-A, S-B               | Category B<br>SW2       | -                | Causes burns to skin, eyes and mucous membranes. Toxic if swallowed, by skin contact or by inhalation.                                      | 2923   |
| 2923   | T3                                 | TP33                | F-A, S-B               | Category B<br>SW2       | -                | See entry above.  | 2923   |
| 2923   | T1                                 | TP33                | F-A, S-B               | Category B<br>SW2       | -                | See entry above.  | 2923   |
| 2924   | T14                                | TP2                 | F-E, S-C               | Category E<br>SW2       | -                | Causes burns to skin, eyes and mucous membranes.  | 2924   |
| 2924   | T11                                | TP2<br>TP27         | F-E, S-C               | Category B<br>SW2       | -                | See entry above.  | 2924   |
| 2924   | T7                                 | TP1<br>TP28         | F-E, S-C               | Category A<br>SW2       | -                | See entry above.  | 2924   |
| 2925   | T3                                 | TP33                | F-A, S-G               | Category D<br>SW2       | -                | Causes burns to skin, eyes and mucous membranes.  | 2925   |
| 2925   | T1                                 | TP33                | F-A, S-G               | Category D<br>SW2       | -                | See entry above.  | 2925   |
| 2926   | T3                                 | TP33                | F-A, S-G               | Category B<br>SW2       | -                | Toxic if swallowed, by skin contact or by dust inhalation. Should be handled with care to minimize exposure, particularly to dust.          | 2926   |
| 2926   | T1                                 | TP33                | F-A, S-G               | Category B<br>SW2       | -                | See entry above.  | 2926   |
| 2927   | T14                                | TP2<br>TP13<br>TP27 | F-A, S-B               | Category B<br>SW2       | -                | Toxic if swallowed, by skin contact or by inhalation. Causes burns to skin, eyes and mucous membranes.                                      | 2927   |
| 2927   | T11                                | TP2<br>TP27         | F-A, S-B               | Category B<br>SW2       | -                | See entry above.  | 2927   |
| 2928   | T6                                 | TP33                | F-A, S-B               | Category B<br>SW2       | -                | Toxic if swallowed, by skin contact or by inhalation. Causes burns to skin, eyes and mucous membranes.                                      | 2928   |
| 2928   | T3                                 | TP33                | F-A, S-B               | Category B<br>SW2       | -                | See entry above.  | 2928   |
| 2929   | T14                                | TP2<br>TP13<br>TP27 | F-E, S-D               | Category B<br>SW2       | -                | Toxic if swallowed, by skin contact or by inhalation.   | 2929   |
| 2929   | T11                                | TP2<br>TP13<br>TP27 | F-E, S-D               | Category B<br>SW2       | -                | See entry above.  | 2929   |
| 2930   | T6                                 | TP33                | F-A, S-G               | Category B              | -                | Toxic if swallowed, by skin contact or by inhalation.   | 2930   |
| 2930   | T3                                 | TP33                | F-A, S-G               | Category B              | -                | See entry above.  | 2930   |
| 2931   | T3                                 | TP33                | F-A, S-A               | Category A              | -                | Blue, crystalline powder. Soluble in water. Toxic if swallowed, by skin contact or by dust inhalation.                                      | 2931   |
| 2933   | T2                                 | TP1                 | F-E, S-D               | Category A              | -                | Colourless liquid with an ether-like odour. Flashpoint: 32°C c.c. Slightly soluble in water. Irritating to skin, eyes and mucous membranes. | 2933   |
| 2934   | T2                                 | TP1                 | F-E, S-D               | Category A              | -                | Colourless liquid with a sweetish odour. Flashpoint: 50°C c.c. Immiscible with water. Irritating to skin, eyes and mucous membranes.        | 2934   |



Part 3 – Dangerous Goods List, special provisions and exceptions

Chapter 3.2 – Dangerous Goods List

| UN No. | Proper shipping name (PSN)   | Class or division | Subsidiary hazard(s) | Packing group  | Special provisions | Limited and excepted quantity provisions |                     | Packing      |              | IBC           |               |
|--------|--|-------------------|----------------------|----------------|--------------------|--|---------------------|--------------|--------------|---------------|---------------|
|        |  |                   |                      |                |                    | Limited quantities                       | Excepted quantities | Instructions | Provisions   | Instructions  | Provisions    |
| (1)    | (2)<br>3.1.2   | (3)<br>2.0        | (4)<br>2.0           | (5)<br>2.0.1.3 | (6)<br>3.3         | (7a)<br>3.4                              | (7b)<br>3.5         | (8)<br>4.1.4 | (9)<br>4.1.4 | (10)<br>4.1.4 | (11)<br>4.1.4 |
| 2935   | ETHYL 2-CHLOROPROPIONATE   | 3                 | –                    | III            | –                  | 5 L                                      | E1                  | P001<br>LP01 | –            | IBC03         | –             |
| 2936   | THIOLACTIC ACID  | 6.1               | –                    | II             | –                  | 100 mL                                   | E4                  | P001         | –            | IBC02         | –             |
| 2937   | alpha-METHYLBENZYL ALCOHOL, LIQUID   | 6.1               | –                    | III            | –                  | 5 L                                      | E1                  | P001<br>LP01 | –            | IBC03         | –             |
| 2940   | 9-PHOSPHABICYCLONANES (CYCLOOCTADIENE-PHOSPHINES)                              | 4.2               | –                    | II             | –                  | 0  | E2                  | P410         | PP31         | IBC06         | B21           |
| 2941   | FLUOROANILINES   | 6.1               | –                    | III            | –                  | 5 L                                      | E1                  | P001<br>LP01 | –            | IBC03         | –             |
| 2942   | 2-TRIFLUOROMETHYLANILINE   | 6.1               | –                    | III            | –                  | 5 L                                      | E1                  | P001<br>LP01 | –            | IBC03         | –             |
| 2943   | TETRAHYDRO-FURFURYLAMINE   | 3                 | –                    | III            | –                  | 5 L                                      | E1                  | P001<br>LP01 | –            | IBC03         | –             |
| 2945   | N-METHYLBUTYLAMINE   | 3                 | 8                    | II             | –                  | 1 L                                      | E2                  | P001         | –            | IBC02         | –             |
| 2946   | 2-AMINO-5-DIETHYLAMINO-PENTANE   | 6.1               | –                    | III            | –                  | 5 L                                      | E1                  | P001<br>LP01 | –            | IBC03         | –             |
| 2947   | ISOPROPYL CHLOROACETATE  | 3                 | –                    | III            | –                  | 5 L                                      | E1                  | P001<br>LP01 | –            | IBC03         | –             |
| 2948   | 3-TRIFLUOROMETHYLANILINE   | 6.1               | –                    | II             | –                  | 100 mL                                   | E4                  | P001         | –            | IBC02         | –             |
| 2949   | SODIUM HYDROSULPHIDE, HYDRATED with not less than 25% water of crystallization | 8                 | –                    | II             | –                  | 1 kg                                     | E2                  | P002         | –            | IBC08         | B4<br>B21     |
| 2950   | MAGNESIUM GRANULES, COATED, particle size not less than 149 microns            | 4.3               | –                    | III            | 920                | 1 kg                                     | E1                  | P410         | PP100        | IBC08         | B4            |
| △ 2956 | 5-tert-BUTYL-2,4,6-TRINITRO-m-XYLENE (MUSK XYLENE)                             | 4.1               | –                    | III            | 133                | 0  | E0                  | P409         | –            | –             | –             |
| 2965   | BORON TRIFLUORIDE DIMETHYL ETHERATE  | 4.3               | 3/8                  | I              | –                  | 0  | E0                  | P401         | PP31         | –             | –             |
| 2966   | THIOGLYCOL   | 6.1               | –                    | II             | –                  | 100 mL                                   | E4                  | P001         | –            | IBC02         | –             |
| 2967   | SULPHAMIC ACID   | 8                 | –                    | III            | –                  | 5 kg                                     | E1                  | P002<br>LP02 | –            | IBC08         | B3            |
| 2968   | MANEB, STABILIZED or MANEB PREPARATION, STABILIZED against self-heating        | 4.3               | –<br>P               | III            | 223<br>946         | 1 kg                                     | E1                  | P002         | PP100        | IBC08         | B4            |

| UN No. | Portable tanks and bulk containers |                    | EmS                    | Stowage and handling                         | Segregation                        | Properties and observations  | UN No. |
|--------|------------------------------------|--------------------|------------------------|--|------------------------------------|--|--------|
|        | Tank instructions                  | Provisions         |                        |  |                                    |  |        |
| (12)   | (13)<br>4.2.5<br>4.3               | (14)<br>4.2.5      | (15)<br>5.4.3.4<br>7.8 | (16a)<br>7.1<br>7.3–7.7                      | (16b)<br>7.2–7.7                   | (17)   | (18)   |
| –      | T2                                 | TP1                | F-E, S-D               | Category A                                   | –                                  | Colourless liquid with a pungent odour. Flashpoint: 38°C c.c. Immiscible with water. Irritating to skin, eyes and mucous membranes.  | 2935   |
| –      | T7                                 | TP2                | F-A, S-A               | Category A                                   | –                                  | Oily liquid with a foul odour. Melting point: 10°C. Miscible with water. Toxic if swallowed, by skin contact or by inhalation.   | 2936   |
| –      | T4                                 | TP1                | F-A, S-A               | Category A                                   | –                                  | Colourless liquid. Slightly miscible with water. Melting point: 21°C (pure substance). Toxic if swallowed, by skin contact or by inhalation.   | 2937   |
| –      | T3                                 | TP33               | F-A, S-J               | Category A                                   | –                                  | Colourless, waxy solids. Melting point: 40°C to 60°C. React in contact with materials such as sawdust or other cellulose-based materials, resulting in charring and evolution of toxic fumes. Irritating to skin, eyes and mucous membranes.                   | 2940   |
| –      | T4                                 | TP1                | F-A, S-A               | Category A                                   | –                                  | Liquids. Freezing points: –28°C to –2°C. Immiscible with water. Toxic if swallowed, by skin contact or by inhalation.  | 2941   |
| –      | –                                  | –                  | F-A, S-A               | Category A                                   | –                                  | Liquid. Immiscible with water. Toxic if swallowed, by skin contact or by inhalation.   | 2942   |
| –      | T2                                 | TP1                | F-E, S-D               | Category A                                   | –                                  | Colourless to yellowish liquid with an ammoniacal odour. Flashpoint: 45°C c.c. Miscible with water. Harmful by inhalation. Irritating to skin, eyes and mucous membranes.  | 2943   |
| –      | T7                                 | TP1                | F-E, S-C               | Category B<br>SW2                            | SG35                               | Colourless liquid. Flashpoint: 0°C c.c. Miscible with water. Harmful by inhalation. Causes burns to skin and eyes. Irritating to mucous membranes.   | 2945   |
| –      | T4                                 | TP1                | F-A, S-A               | Category A                                   | –                                  | Liquid with an acrid odour. Miscible with water. Toxic if swallowed, by skin contact or by inhalation.   | 2946   |
| –      | T2                                 | TP1                | F-E, S-D               | Category A                                   | –                                  | Colourless liquid with a pungent odour. Flashpoint: 56°C c.c. Slightly soluble in water. Harmful by inhalation. Irritating to skin, eyes and mucous membranes.   | 2947   |
| –      | T7                                 | TP2                | F-A, S-A               | Category A<br>SW2                            | –                                  | Colourless to yellowish liquid. Melting point: 5°C. Slightly miscible with water. Toxic if swallowed, by skin contact or by inhalation.  | 2948   |
| –      | T7                                 | TP2                | F-A, S-B               | Category A                                   | SGG18<br>SG35                      | Colourless needles or yellow flakes. Soluble in water with a foul odour. Melting point: 52°C. Reacts violently with acids, evolving hydrogen sulphide, a toxic and flammable gas. Causes burns to skin, eyes and mucous membranes.                             | 2949   |
| –      | T1<br>BK2                          | TP33               | F-G, S-O               | Category A<br>H1                             | SGG15<br>SG26<br>SG35              | Coated granules with particle size ranging from 149 to 2,000 microns. In contact with water or acids, evolve hydrogen, a flammable gas.  | 2950   |
| –      | –                                  | –                  | F-B, S-G               | Category D<br>SW1<br>SW2<br>SW11<br>H2<br>H3 | SG1                                | Insoluble in water. May explode if involved in a fire under confined conditions. Sensitive to strong detonation shock. Harmful if swallowed or by skin contact.  | 2956 △ |
| –      | T10                                | TP2<br>TP7<br>TP13 | F-G, S-O               | Category D<br>SW2<br>H1                      | SG5<br>SG8<br>SG13<br>SG25<br>SG26 | Colourless, flammable liquid. Flashpoint: 20°C c.c. but widely variable, depending upon free ether content. Freezing point: –14°C. Decomposes in contact with water, forming dimethyl ether, a flammable gas. Causes burns to skin, eyes and mucous membranes. | 2965   |
| –      | T7                                 | TP2                | F-A, S-A               | Category A                                   | –                                  | Colourless liquid with a foul odour. Miscible with water. Decomposes when heated, evolving sulphur dioxide. Toxic if swallowed, by skin contact or by inhalation.  | 2966   |
| –      | T1                                 | TP33               | F-A, S-B               | Category A                                   | SGG1<br>SG36<br>SG49               | White crystalline powder. Soluble in water. Decomposes when heated, evolving toxic fumes. Causes burns to skin, eyes and mucous membranes.   | 2967   |
| –      | T1                                 | TP33               | F-G, S-L               | Category B<br>H1                             | SG26<br>SG29<br>SG35               | Yellow powder. May evolve toxic, irritating or flammable fumes when wet, when involved in a fire or in contact with acids. Requires certification from the shipper that the substance is not class 4.2.  | 2968   |

Part 3 – Dangerous Goods List, special provisions and exceptions

Chapter 3.2 – Dangerous Goods List

| UN No. | Proper shipping name (PSN)  | Class or division | Subsidiary hazard(s) | Packing group  | Special provisions | Limited and excepted quantity provisions |                          | Packing          |                | IBC               |                 |
|--------|---|-------------------|----------------------|----------------|--------------------|--|--------------------------|------------------|----------------|-------------------|-----------------|
|        |   |                   |                      |                |                    | Limited quantities (7a)                  | Excepted quantities (7b) | Instructions (8) | Provisions (9) | Instructions (10) | Provisions (11) |
| (1)    | (2)<br>3.1.2  | (3)<br>2.0        | (4)<br>2.0           | (5)<br>2.0.1.3 | (6)<br>3.3         | (7a)<br>3.4                              | (7b)<br>3.5              | (8)<br>4.1.4     | (9)<br>4.1.4   | (10)<br>4.1.4     | (11)<br>4.1.4   |
| 2969   | CASTOR BEANS or CASTOR MEAL or CASTOR POMACE or CASTOR FLAKE  | 9                 | –                    | II             | 141                | 5 kg                                     | E2                       | P002             | PP34           | IBC08             | B4<br>B21       |
| 2977   | RADIOACTIVE MATERIAL, URANIUM HEXAFLUORIDE, FISSILE   | 7                 | 6.1/8                | –              | –                  | 0  | E0                       | See 4.1.9        | See 4.1.9      | See 4.1.9         | See 4.1.9       |
| 2978   | RADIOACTIVE MATERIAL, URANIUM HEXAFLUORIDE non fissile or fissile-excepted  | 7                 | 6.1/8                | –              | 317                | 0  | E0                       | See 4.1.9        | See 4.1.9      | See 4.1.9         | See 4.1.9       |
| 2983   | ETHYLENE OXIDE AND PROPYLENE OXIDE MIXTURE with not more than 30% ethylene oxide  | 3                 | 6.1                  | I              | –                  | 0  | E0                       | P001             | –              | –                 | –               |
| 2984   | HYDROGEN PEROXIDE, AQUEOUS SOLUTION with not less than 8% but less than 20% hydrogen peroxide (stabilized as necessary) | 5.1               | –                    | III            | 65                 | 5 L                                      | E1                       | P504             | –              | IBC02             | B5              |
| 2985   | CHLOROSILANES, FLAMMABLE, CORROSIVE, N.O.S.   | 3                 | 8                    | II             | –                  | 0  | E0                       | P010             | –              | –                 | –               |
| 2986   | CHLOROSILANES, CORROSIVE, FLAMMABLE, N.O.S.   | 8                 | 3                    | II             | –                  | 0  | E0                       | P010             | –              | –                 | –               |
| 2987   | CHLOROSILANES, CORROSIVE, N.O.S.  | 8                 | –                    | II             | –                  | 0  | E0                       | P010             | –              | –                 | –               |
| 2988   | CHLOROSILANES, WATER-REACTIVE, FLAMMABLE, CORROSIVE, N.O.S.   | 4.3               | 3/8                  | I              | –                  | 0  | E0                       | P401             | PP31           | –                 | –               |
| 2989   | LEAD PHOSPHITE, DIBASIC   | 4.1               | –                    | II             | 922                | 1 kg                                     | E2                       | P002             | –              | IBC08             | B4<br>B21       |
| 2989   | LEAD PHOSPHITE, DIBASIC   | 4.1               | –                    | III            | 922                | 5 kg                                     | E1                       | P002<br>LP02     | –              | IBC08             | B3              |

| UN No. | Portable tanks and bulk containers |                            | EmS                    | Stowage and handling      | Segregation  | Properties and observations  | UN No. |
|--------|------------------------------------|----------------------------|------------------------|---------------------------|--|--|--------|
|        | Tank instructions (12)             | Provisions (14)            |                        |                           |  |  |        |
| (12)   | (13)<br>4.2.5<br>4.3               | (14)<br>4.2.5              | (15)<br>5.4.3.4<br>7.8 | (16a)<br>7.1<br>7.3–7.7   | (16b)<br>7.2–7.7   | (17)   | (18)   |
| –      | T3<br>BK2                          | TP33                       | F-A, S-A               | Category E<br>SW2         | SG10<br>SG18<br>SG29                                       | Whole beans or meal. The latter is the residue remaining after the oil has been extracted from the seeds. Castor beans contain a powerful allergen which, by inhalation of dust or by skin contact with crushed bean products, can give rise to severe irritation of the skin, eyes and mucous membranes in some persons. They are also toxic by ingestion. When handling these products, wear at least a dust mask and goggles. Avoid unnecessary skin contact. | 2969   |
| –      | –                                  | –                          | F-I, S-S               | Category B<br>SW2<br>SW12 | SG17<br>SG76<br>SG78                                       | See 1.5.1.   | 2977   |
| –      | –                                  | –                          | F-I, S-S               | Category B<br>SW2<br>SW12 | SG17<br>SG76<br>SG78                                       | See 1.5.1.   | 2978   |
| –      | T14                                | TP2<br>TP7<br>TP13         | F-E, S-D               | Category E<br>SW1<br>SW2  | –  | Colourless, volatile liquid with an ethereal odour. Flashpoint: below –18°C c.c. Explosive limits: 2.2% to 55%. Boiling point: 23°C to 28°C. Miscible with water. Corrosive to aluminium. Toxic if swallowed, by skin contact or by inhalation. Irritating to eyes and mucous membranes.   | 2983   |
| –      | T4                                 | TP1<br>TP6<br>TP24         | F-H, S-Q               | Category B<br>SW1         | SG16<br>SG59<br>SG72                                       | Colourless liquid. Slowly decomposes, evolving oxygen; the rate of decomposition increases in contact with metals, except aluminium.   | 2984   |
| –      | T14                                | TP2<br>TP7<br>TP13<br>TP27 | F-E, S-C               | Category B<br>SW2         | SGG1<br>SG36<br>SG49                                       | Colourless liquids with a pungent odour. When involved in a fire, evolve toxic gases. React violently with water, evolving hydrogen chloride, an irritating and corrosive gas. In the presence of moisture, highly corrosive to most metals. Cause burns to skin, eyes and mucous membranes.   | 2985   |
| –      | T14                                | TP2<br>TP7<br>TP13<br>TP27 | F-E, S-C               | Category C<br>SW2         | SGG1<br>SG36<br>SG49                                       | Colourless, flammable liquids with a pungent odour. Immiscible with water. React violently with water or steam, evolving hydrogen chloride, an irritating and corrosive gas apparent as white fumes. When involved in a fire, evolve toxic gas. In the presence of moisture, highly corrosive to most metals. Cause burns to skin, eyes and mucous membranes.  | 2986   |
| –      | T14                                | TP2<br>TP7<br>TP13<br>TP27 | F-A, S-B               | Category C<br>SW2         | SGG1<br>SG36<br>SG49                                       | Colourless liquids with a pungent odour. Immiscible with water. React violently with water or steam, evolving hydrogen chloride, an irritating and corrosive gas apparent as white fumes. When involved in a fire, evolve toxic gases. In the presence of moisture, highly corrosive to most metals. Cause burns to skin, eyes and mucous membranes.   | 2987   |
| –      | T14                                | TP2<br>TP7<br>TP13         | F-G, S-N               | Category D<br>SW2<br>H1   | SGG1<br>SG5<br>SG8<br>SG13<br>SG25<br>SG26<br>SG36<br>SG49 | Colourless, very volatile liquids, flammable and corrosive, with a pungent odour. Immiscible with water. React violently with water or steam to produce heat which may lead to self-ignition; toxic and corrosive fumes will be evolved. May react vigorously in contact with oxidizing substances. Cause burns to skin, eyes and mucous membranes.  | 2988   |
| –      | T3                                 | TP33                       | F-A, S-G               | Category B                | SGG7<br>SGG9<br>SG29                                       | Fine white crystals or powder. Insoluble in water. Combustion can be sustained, even in the absence of air. Harmful if swallowed.  | 2989   |
| –      | T1                                 | TP33                       | F-A, S-G               | Category B                | SGG7<br>SGG9<br>SG29                                       | See entry above.   | 2989   |

Part 3 – Dangerous Goods List, special provisions and exceptions

Chapter 3.2 – Dangerous Goods List

| UN No. | Proper shipping name (PSN)  | Class or division | Subsidiary hazard(s) | Packing group  | Special provisions | Limited and excepted quantity provisions |                     | Packing      |              | IBC           |               |
|--------|---|-------------------|----------------------|----------------|--------------------|--|---------------------|--------------|--------------|---------------|---------------|
|        |   |                   |                      |                |                    | Limited quantities                       | Excepted quantities | Instructions | Provisions   | Instructions  | Provisions    |
| (1)    | (2)<br>3.1.2  | (3)<br>2.0        | (4)<br>2.0           | (5)<br>2.0.1.3 | (6)<br>3.3         | (7a)<br>3.4                              | (7b)<br>3.5         | (8)<br>4.1.4 | (9)<br>4.1.4 | (10)<br>4.1.4 | (11)<br>4.1.4 |
| 2990   | LIFE-SAVING APPLIANCES, SELF-INFLATING  | 9                 | –                    | –              | 296                | 0  | E0                  | P905         | –            | –             | –             |
| 2991   | CARBAMATE PESTICIDE, LIQUID, TOXIC, FLAMMABLE, flashpoint not less than 23°C      | 6.1               | 3                    | I              | 61<br>274          | 0  | E5                  | P001         | –            | –             | –             |
| 2991   | CARBAMATE PESTICIDE, LIQUID, TOXIC, FLAMMABLE, flashpoint not less than 23°C      | 6.1               | 3                    | II             | 61<br>274          | 100 mL                                   | E4                  | P001         | –            | IBC02         | –             |
| 2991   | CARBAMATE PESTICIDE, LIQUID, TOXIC, FLAMMABLE, flashpoint not less than 23°C      | 6.1               | 3                    | III            | 61<br>223<br>274   | 5 L                                      | E1                  | P001<br>LP01 | –            | IBC03         | –             |
| 2992   | CARBAMATE PESTICIDE, LIQUID, TOXIC  | 6.1               | –                    | I              | 61<br>274          | 0  | E5                  | P001         | –            | –             | –             |
| 2992   | CARBAMATE PESTICIDE, LIQUID, TOXIC  | 6.1               | –                    | II             | 61<br>274          | 100 mL                                   | E4                  | P001         | –            | IBC02         | –             |
| 2992   | CARBAMATE PESTICIDE, LIQUID, TOXIC  | 6.1               | –                    | III            | 61<br>223<br>274   | 5 L                                      | E1                  | P001<br>LP01 | –            | IBC03         | –             |
| 2993   | ARSENICAL PESTICIDE, LIQUID, TOXIC, FLAMMABLE, flashpoint not less than 23°C      | 6.1               | 3                    | I              | 61<br>274          | 0  | E5                  | P001         | –            | –             | –             |
| 2993   | ARSENICAL PESTICIDE, LIQUID, TOXIC, FLAMMABLE, flashpoint not less than 23°C      | 6.1               | 3                    | II             | 61<br>274          | 100 mL                                   | E4                  | P001         | –            | IBC02         | –             |
| 2993   | ARSENICAL PESTICIDE, LIQUID, TOXIC, FLAMMABLE, flashpoint not less than 23°C      | 6.1               | 3                    | III            | 61<br>223<br>274   | 5 L                                      | E1                  | P001         | –            | IBC03         | –             |
| 2994   | ARSENICAL PESTICIDE, LIQUID, TOXIC  | 6.1               | –                    | I              | 61<br>274          | 0  | E5                  | P001         | –            | –             | –             |
| 2994   | ARSENICAL PESTICIDE, LIQUID, TOXIC  | 6.1               | –                    | II             | 61<br>274          | 100 mL                                   | E4                  | P001         | –            | IBC02         | –             |
| 2994   | ARSENICAL PESTICIDE, LIQUID, TOXIC  | 6.1               | –                    | III            | 61<br>223<br>274   | 5 L                                      | E1                  | P001<br>LP01 | –            | IBC03         | –             |
| 2995   | ORGANOCHLORINE PESTICIDE, LIQUID, TOXIC, FLAMMABLE, flashpoint not less than 23°C | 6.1               | 3                    | I              | 61<br>274          | 0  | E5                  | P001         | –            | –             | –             |
| 2995   | ORGANOCHLORINE PESTICIDE, LIQUID, TOXIC, FLAMMABLE, flashpoint not less than 23°C | 6.1               | 3                    | II             | 61<br>274          | 100 mL                                   | E4                  | P001         | –            | IBC02         | –             |
| 2995   | ORGANOCHLORINE PESTICIDE, LIQUID, TOXIC, FLAMMABLE, flashpoint not less than 23°C | 6.1               | 3                    | III            | 61<br>223<br>274   | 5 L                                      | E1                  | P001         | –            | IBC03         | –             |

| UN No. | Portable tanks and bulk containers |                     | EmS                    | Stowage and handling    | Segregation      | Properties and observations   | UN No. |
|--------|------------------------------------|---------------------|------------------------|-------------------------|------------------|---|--------|
|        | Tank instructions                  | Provisions          |                        |                         |                  |   |        |
| (12)   | (13)<br>4.2.5<br>4.3               | (14)<br>4.2.5       | (15)<br>5.4.3.4<br>7.8 | (16a)<br>7.1<br>7.3–7.7 | (16b)<br>7.2–7.7 | (17)  | (18)   |
| –      | –                                  | –                   | F-A, S-V               | Category A              | SG18<br>SG71     | These articles may contain:<br>.1 class 2.2 compressed gases;<br>.2 signal devices (class 1) which may include smoke and illumination signal flares; signal devices must be packed in plastic or fibreboard inner packagings;<br>.3 electric storage batteries;<br>.4 first aid kit; or<br>.5 "strike anywhere" matches.                  | 2990   |
| –      | T14                                | TP2<br>TP13<br>TP27 | F-E, S-D               | Category B<br>SW2       | –                | Liquid flammable pesticides having a flashpoint between 23°C and 60°C c.c., presenting a very wide range of toxic hazard. They frequently contain petroleum or coal tar distillates, or other flammable liquids. Flashpoint and miscibility with water depend upon the composition. Toxic if swallowed, by skin contact or by inhalation. | 2991   |
| –      | T11                                | TP2<br>TP13<br>TP27 | F-E, S-D               | Category B<br>SW2       | –                | See entry above.  | 2991   |
| –      | T7                                 | TP2<br>TP28         | F-E, S-D               | Category A<br>SW2       | –                | See entry above.  | 2991   |
| –      | T14                                | TP2<br>TP13<br>TP27 | F-A, S-A               | Category B<br>SW2       | –                | Miscibility with water depends upon the composition. Toxic if swallowed, by skin contact or by inhalation.  | 2992   |
| –      | T11                                | TP2<br>TP13<br>TP27 | F-A, S-A               | Category B<br>SW2       | –                | See entry above.  | 2992   |
| –      | T7                                 | TP2<br>TP28         | F-A, S-A               | Category A<br>SW2       | –                | See entry above.  | 2992   |
| –      | T14                                | TP2<br>TP13<br>TP27 | F-E, S-D               | Category B<br>SW2       | –                | Liquid flammable pesticides having a flashpoint between 23°C and 60°C c.c., presenting a very wide range of toxic hazard. They frequently contain petroleum or coal tar distillates, or other flammable liquids. Flashpoint and miscibility with water depend upon the composition. Toxic if swallowed, by skin contact or by inhalation. | 2993   |
| –      | T11                                | TP2<br>TP13<br>TP27 | F-E, S-D               | Category B<br>SW2       | –                | See entry above.  | 2993   |
| –      | T7                                 | TP2<br>TP28         | F-E, S-D               | Category A<br>SW2       | –                | See entry above.  | 2993   |
| –      | T14                                | TP2<br>TP13<br>TP27 | F-A, S-A               | Category B<br>SW2       | –                | Liquid pesticides which present a very wide range of toxic hazard. Miscibility with water depends upon the composition. Toxic if swallowed, by skin contact or by inhalation.   | 2994   |
| –      | T11                                | TP2<br>TP13<br>TP27 | F-A, S-A               | Category B<br>SW2       | –                | See entry above.  | 2994   |
| –      | T7                                 | TP2<br>TP28         | F-A, S-A               | Category A<br>SW2       | –                | See entry above.  | 2994   |
| –      | T14                                | TP2<br>TP13<br>TP27 | F-E, S-D               | Category B<br>SW2       | –                | It frequently contains petroleum or coal tar distillates, or other flammable liquids. Flashpoint and miscibility with water depend upon the composition. Toxic if swallowed, by skin contact or by inhalation.  | 2995   |
| –      | T11                                | TP2<br>TP13<br>TP27 | F-E, S-D               | Category B<br>SW2       | –                | See entry above.  | 2995   |
| –      | T7                                 | TP2<br>TP28         | F-E, S-D               | Category A<br>SW2       | –                | See entry above.  | 2995   |

Part 3 – Dangerous Goods List, special provisions and exceptions

Chapter 3.2 – Dangerous Goods List

| UN No. | Proper shipping name (PSN)   | Class or division | Subsidiary hazard(s) | Packing group  | Special provisions | Limited and excepted quantity provisions |                     | Packing      |              | IBC           |               |
|--------|--|-------------------|----------------------|----------------|--------------------|--|---------------------|--------------|--------------|---------------|---------------|
|        |  |                   |                      |                |                    | Limited quantities                       | Excepted quantities | Instructions | Provisions   | Instructions  | Provisions    |
| (1)    | (2)<br>3.1.2   | (3)<br>2.0        | (4)<br>2.0           | (5)<br>2.0.1.3 | (6)<br>3.3         | (7a)<br>3.4                              | (7b)<br>3.5         | (8)<br>4.1.4 | (9)<br>4.1.4 | (10)<br>4.1.4 | (11)<br>4.1.4 |
| 2996   | ORGANOCHLORINE PESTICIDE, LIQUID, TOXIC  | 6.1               | –                    | I              | 61<br>274          | 0  | E5                  | P001         | –            | –             | –             |
| 2996   | ORGANOCHLORINE PESTICIDE, LIQUID, TOXIC  | 6.1               | –                    | II             | 61<br>274          | 100 mL                                   | E4                  | P001         | –            | IBC02         | –             |
| 2996   | ORGANOCHLORINE PESTICIDE, LIQUID, TOXIC  | 6.1               | –                    | III            | 61<br>223<br>274   | 5 L                                      | E1                  | P001<br>LP01 | –            | IBC03         | –             |
| 2997   | TRIAZINE PESTICIDE, LIQUID, TOXIC, FLAMMABLE, flashpoint not less than 23°C      | 6.1               | 3                    | I              | 61<br>274          | 0  | E5                  | P001         | –            | –             | –             |
| 2997   | TRIAZINE PESTICIDE, LIQUID, TOXIC, FLAMMABLE, flashpoint not less than 23°C      | 6.1               | 3                    | II             | 61<br>274          | 100 mL                                   | E4                  | P001         | –            | IBC02         | –             |
| 2997   | TRIAZINE PESTICIDE, LIQUID, TOXIC, FLAMMABLE, flashpoint not less than 23°C      | 6.1               | 3                    | III            | 61<br>223<br>274   | 5 L                                      | E1                  | P001         | –            | IBC03         | –             |
| 2998   | TRIAZINE PESTICIDE, LIQUID, TOXIC  | 6.1               | –                    | I              | 61<br>274          | 0  | E5                  | P001         | –            | –             | –             |
| 2998   | TRIAZINE PESTICIDE, LIQUID, TOXIC  | 6.1               | –                    | II             | 61<br>274          | 100 mL                                   | E4                  | P001         | –            | IBC02         | –             |
| 2998   | TRIAZINE PESTICIDE, LIQUID, TOXIC  | 6.1               | –                    | III            | 61<br>223<br>274   | 5 L                                      | E1                  | P001<br>LP01 | –            | IBC03         | –             |
| 3005   | THIOCARBAMATE PESTICIDE, LIQUID, TOXIC, FLAMMABLE, flashpoint not less than 23°C | 6.1               | 3                    | I              | 61<br>274          | 0  | E5                  | P001         | –            | –             | –             |
| 3005   | THIOCARBAMATE PESTICIDE, LIQUID, TOXIC, FLAMMABLE, flashpoint not less than 23°C | 6.1               | 3                    | II             | 61<br>274          | 100 mL                                   | E4                  | P001         | –            | IBC02         | –             |
| 3005   | THIOCARBAMATE PESTICIDE, LIQUID, TOXIC, FLAMMABLE, flashpoint not less than 23°C | 6.1               | 3                    | III            | 61<br>223<br>274   | 5 L                                      | E1                  | P001         | –            | IBC03         | –             |
| 3006   | THIOCARBAMATE PESTICIDE, LIQUID, TOXIC   | 6.1               | –                    | I              | 61<br>274          | 0  | E5                  | P001         | –            | –             | –             |
| 3006   | THIOCARBAMATE PESTICIDE, LIQUID, TOXIC   | 6.1               | –                    | II             | 61<br>274          | 100 mL                                   | E4                  | P001         | –            | IBC02         | –             |
| 3006   | THIOCARBAMATE PESTICIDE, LIQUID, TOXIC   | 6.1               | –                    | III            | 61<br>223<br>274   | 5 L                                      | E1                  | P001<br>LP01 | –            | IBC03         | –             |
| 3009   | COPPER BASED PESTICIDE, LIQUID, TOXIC, FLAMMABLE, flashpoint not less than 23°C  | 6.1               | 3                    | I              | 61<br>274          | 0  | E5                  | P001         | –            | –             | –             |
| 3009   | COPPER BASED PESTICIDE, LIQUID, TOXIC, FLAMMABLE, flashpoint not less than 23°C  | 6.1               | 3                    | II             | 61<br>274          | 100 mL                                   | E4                  | P001         | –            | IBC02         | –             |

| UN No. | Portable tanks and bulk containers |                     | EmS                    | Stowage and handling    | Segregation      | Properties and observations   | UN No. |
|--------|------------------------------------|---------------------|------------------------|-------------------------|------------------|---|--------|
|        | Tank instructions                  | Provisions          |                        |                         |                  |   |        |
| (12)   | (13)<br>4.2.5<br>4.3               | (14)<br>4.2.5       | (15)<br>5.4.3.4<br>7.8 | (16a)<br>7.1<br>7.3–7.7 | (16b)<br>7.2–7.7 | (17)  | (18)   |
| –      | T14                                | TP2<br>TP13<br>TP27 | F-A, S-A               | Category B<br>SW2       | –                | Miscibility with water depends upon the composition. Toxic if swallowed, by skin contact or by inhalation.  | 2996   |
| –      | T11                                | TP2<br>TP13<br>TP27 | F-A, S-A               | Category B<br>SW2       | –                | See entry above.  | 2996   |
| –      | T7                                 | TP2<br>TP28         | F-A, S-A               | Category A<br>SW2       | –                | See entry above.  | 2996   |
| –      | T14                                | TP2<br>TP13<br>TP27 | F-E, S-D               | Category B<br>SW2       | –                | It frequently contains petroleum or coal tar distillates, or other flammable liquids. Flashpoint and miscibility with water depend upon the composition. Toxic if swallowed, by skin contact or by inhalation.  | 2997   |
| –      | T11                                | TP2<br>TP13<br>TP27 | F-E, S-D               | Category B<br>SW2       | –                | See entry above.  | 2997   |
| –      | T7                                 | TP2<br>TP28         | F-E, S-D               | Category A<br>SW2       | –                | See entry above.  | 2997   |
| –      | T14                                | TP2<br>TP13<br>TP27 | F-A, S-A               | Category B<br>SW2       | –                | See alphabetical index to identify those pesticides which are marine pollutants. Liquid pesticides which present a very wide range of toxic hazard. Miscibility with water depends upon the composition. Toxic if swallowed, by skin contact or by inhalation.  | 2998   |
| –      | T11                                | TP2<br>TP13<br>TP27 | F-A, S-A               | Category B<br>SW2       | –                | See entry above.  | 2998   |
| –      | T7                                 | TP2<br>TP28         | F-A, S-A               | Category A<br>SW2       | –                | See entry above.  | 2998   |
| –      | T14                                | TP2<br>TP13         | F-E, S-D               | Category B<br>SW2       | –                | Liquid flammable pesticides having a flashpoint between 23°C and 60°C c.c., presenting a very wide range of toxic hazard. They frequently contain petroleum or coal tar distillates, or other flammable liquids. Flashpoint and miscibility with water depend upon the composition. Toxic if swallowed, by skin contact or by inhalation. | 3005   |
| –      | T11                                | TP2<br>TP13<br>TP27 | F-E, S-D               | Category B<br>SW2       | –                | See entry above.  | 3005   |
| –      | T7                                 | TP2<br>TP28         | F-E, S-D               | Category A<br>SW2       | –                | See entry above.  | 3005   |
| –      | T14                                | TP2<br>TP13         | F-A, S-A               | Category B<br>SW2       | –                | Liquid pesticides which present a very wide range of toxic hazard. Miscibility with water depends upon the composition. Toxic if swallowed, by skin contact or by inhalation.   | 3006   |
| –      | T11                                | TP2<br>TP13<br>TP27 | F-A, S-A               | Category B<br>SW2       | –                | See entry above.  | 3006   |
| –      | T7                                 | TP2<br>TP28         | F-A, S-A               | Category A<br>SW2       | –                | See entry above.  | 3006   |
| –      | T14                                | TP2<br>TP13<br>TP27 | F-E, S-D               | Category B<br>SW2       | –                | Liquid flammable pesticides having a flashpoint between 23°C and 60°C c.c., presenting a very wide range of toxic hazard. They frequently contain petroleum or coal tar distillates, or other flammable liquids. Flashpoint and miscibility with water depend upon the composition. Toxic if swallowed, by skin contact or by inhalation. | 3009   |
| –      | T11                                | TP2<br>TP13<br>TP27 | F-E, S-D               | Category B<br>SW2       | –                | See entry above.  | 3009   |



Part 3 – Dangerous Goods List, special provisions and exceptions

Chapter 3.2 – Dangerous Goods List

| UN No. | Proper shipping name (PSN)   | Class or division | Subsidiary hazard(s) | Packing group  | Special provisions | Limited and excepted quantity provisions |                     | Packing      |              | IBC           |               |
|--------|--|-------------------|----------------------|----------------|--------------------|--|---------------------|--------------|--------------|---------------|---------------|
|        |  |                   |                      |                |                    | Limited quantities                       | Excepted quantities | Instructions | Provisions   | Instructions  | Provisions    |
| (1)    | (2)<br>3.1.2   | (3)<br>2.0        | (4)<br>2.0           | (5)<br>2.0.1.3 | (6)<br>3.3         | (7a)<br>3.4                              | (7b)<br>3.5         | (8)<br>4.1.4 | (9)<br>4.1.4 | (10)<br>4.1.4 | (11)<br>4.1.4 |
| 3009   | COPPER BASED PESTICIDE, LIQUID, TOXIC, FLAMMABLE, flashpoint not less than 23°C            | 6.1               | 3                    | III            | 61<br>223<br>274   | 5 L                                      | E1                  | P001         | -            | IBC03         | -             |
| 3010   | COPPER BASED PESTICIDE, LIQUID, TOXIC  | 6.1               | -                    | I              | 61<br>274          | 0  | E5                  | P001         | -            | -             | -             |
| 3010   | COPPER BASED PESTICIDE, LIQUID, TOXIC  | 6.1               | -                    | II             | 61<br>274          | 100 mL                                   | E4                  | P001         | -            | IBC02         | -             |
| 3010   | COPPER BASED PESTICIDE, LIQUID, TOXIC  | 6.1               | -                    | III            | 61<br>223<br>274   | 5 L                                      | E1                  | P001<br>LP01 | -            | IBC03         | -             |
| 3011   | MERCURY BASED PESTICIDE, LIQUID, TOXIC, FLAMMABLE, flashpoint not less than 23°C           | 6.1               | 3<br>P               | I              | 61<br>274          | 0  | E5                  | P001         | -            | -             | -             |
| 3011   | MERCURY BASED PESTICIDE, LIQUID, TOXIC, FLAMMABLE, flashpoint not less than 23°C           | 6.1               | 3<br>P               | II             | 61<br>274          | 100 mL                                   | E4                  | P001         | -            | IBC02         | -             |
| 3011   | MERCURY BASED PESTICIDE, LIQUID, TOXIC, FLAMMABLE, flashpoint not less than 23°C           | 6.1               | 3<br>P               | III            | 61<br>223<br>274   | 5 L                                      | E1                  | P001         | -            | IBC03         | -             |
| 3012   | MERCURY BASED PESTICIDE, LIQUID, TOXIC   | 6.1               | -<br>P               | I              | 61<br>274          | 0  | E5                  | P001         | -            | -             | -             |
| 3012   | MERCURY BASED PESTICIDE, LIQUID, TOXIC   | 6.1               | -<br>P               | II             | 61<br>274          | 100 mL                                   | E4                  | P001         | -            | IBC02         | -             |
| 3012   | MERCURY BASED PESTICIDE, LIQUID, TOXIC   | 6.1               | -<br>P               | III            | 61<br>223<br>274   | 5 L                                      | E1                  | P001<br>LP01 | -            | IBC03         | -             |
| 3013   | SUBSTITUTED NITROPHENOL PESTICIDE, LIQUID, TOXIC, FLAMMABLE, flashpoint not less than 23°C | 6.1               | 3                    | I              | 61<br>274          | 0  | E5                  | P001         | -            | -             | -             |
| 3013   | SUBSTITUTED NITROPHENOL PESTICIDE, LIQUID, TOXIC, FLAMMABLE, flashpoint not less than 23°C | 6.1               | 3                    | II             | 61<br>274          | 100 mL                                   | E4                  | P001         | -            | IBC02         | -             |
| 3013   | SUBSTITUTED NITROPHENOL PESTICIDE, LIQUID, TOXIC, FLAMMABLE, flashpoint not less than 23°C | 6.1               | 3                    | III            | 61<br>223<br>274   | 5 L                                      | E1                  | P001         | -            | IBC03         | -             |
| 3014   | SUBSTITUTED NITROPHENOL PESTICIDE, LIQUID, TOXIC   | 6.1               | -                    | I              | 61<br>274          | 0  | E5                  | P001         | -            | -             | -             |
| 3014   | SUBSTITUTED NITROPHENOL PESTICIDE, LIQUID, TOXIC   | 6.1               | -                    | II             | 61<br>274          | 100 mL                                   | E4                  | P001         | -            | IBC02         | -             |
| 3014   | SUBSTITUTED NITROPHENOL PESTICIDE, LIQUID, TOXIC   | 6.1               | -                    | III            | 61<br>223<br>274   | 5 L                                      | E1                  | P001<br>LP01 | -            | IBC03         | -             |

| UN No. | Portable tanks and bulk containers |                     | EmS                    | Stowage and handling    | Segregation      | Properties and observations   | UN No. |
|--------|------------------------------------|---------------------|------------------------|-------------------------|------------------|---|--------|
|        | Tank instructions                  | Provisions          |                        |                         |                  |   |        |
| (12)   | (13)<br>4.2.5<br>4.3               | (14)<br>4.2.5       | (15)<br>5.4.3.4<br>7.8 | (16a)<br>7.1<br>7.3-7.7 | (16b)<br>7.2-7.7 | (17)  | (18)   |
| -      | T7                                 | TP2<br>TP28         | F-E, S-D               | Category A<br>SW2       | -                | Liquid flammable pesticides having a flashpoint between 23°C and 60°C c.c., presenting a very wide range of toxic hazard. They frequently contain petroleum or coal tar distillates, or other flammable liquids. Flashpoint and miscibility with water depend upon the composition. Toxic if swallowed, by skin contact or by inhalation. | 3009   |
| -      | T14                                | TP2<br>TP13<br>TP27 | F-A, S-A               | Category B<br>SW2       | -                | Liquid pesticides which present a very wide range of toxic hazard. Miscibility with water depends upon the composition. Toxic if swallowed, by skin contact or by inhalation.   | 3010   |
| -      | T11                                | TP2<br>TP13<br>TP27 | F-A, S-A               | Category B<br>SW2       | -                | See entry above.  | 3010   |
| -      | T7                                 | TP2<br>TP28         | F-A, S-A               | Category A<br>SW2       | -                | See entry above.  | 3010   |
| -      | T14                                | TP2<br>TP13<br>TP27 | F-E, S-D               | Category B<br>SW2       | SGG7<br>SGG11    | Liquid flammable pesticides having a flashpoint between 23°C and 60°C c.c., presenting a very wide range of toxic hazard. They frequently contain petroleum or coal tar distillates, or other flammable liquids. Flashpoint and miscibility with water depend upon the composition. Toxic if swallowed, by skin contact or by inhalation. | 3011   |
| -      | T11                                | TP2<br>TP13<br>TP27 | F-E, S-D               | Category B<br>SW2       | SGG7<br>SGG11    | See entry above.  | 3011   |
| -      | T7                                 | TP2<br>TP28         | F-E, S-D               | Category A<br>SW2       | SGG7<br>SGG11    | See entry above.  | 3011   |
| -      | T14                                | TP2<br>TP13<br>TP27 | F-A, S-A               | Category B<br>SW2       | SGG7<br>SGG11    | Liquid pesticides which present a very wide range of toxic hazard. Miscibility with water depends upon the composition. Toxic if swallowed, by skin contact or by inhalation.   | 3012   |
| -      | T11                                | TP2<br>TP13<br>TP27 | F-A, S-A               | Category B<br>SW2       | SGG7<br>SGG11    | See entry above.  | 3012   |
| -      | T7                                 | TP2<br>TP28         | F-A, S-A               | Category A<br>SW2       | SGG7<br>SGG11    | See entry above.  | 3012   |
| -      | T14                                | TP2<br>TP13<br>TP27 | F-E, S-D               | Category B<br>SW2       | -                | Liquid flammable pesticides having a flashpoint between 23°C and 60°C c.c., presenting a very wide range of toxic hazard. They frequently contain petroleum or coal tar distillates, or other flammable liquids. Flashpoint and miscibility with water depend upon the composition. Toxic if swallowed, by skin contact or by inhalation. | 3013   |
| -      | T11                                | TP2<br>TP13<br>TP27 | F-E, S-D               | Category B<br>SW2       | -                | See entry above.  | 3013   |
| -      | T7                                 | TP2<br>TP28         | F-E, S-D               | Category A<br>SW2       | -                | See entry above.  | 3013   |
| -      | T14                                | TP2<br>TP13<br>TP27 | F-A, S-A               | Category B<br>SW2       | -                | Liquid pesticides which present a very wide range of toxic hazard. Miscibility with water depends upon the composition. Toxic if swallowed, by skin contact or by inhalation.   | 3014   |
| -      | T11                                | TP2<br>TP13<br>TP27 | F-A, S-A               | Category B<br>SW2       | -                | See entry above.  | 3014   |
| -      | T7                                 | TP2<br>TP28         | F-A, S-A               | Category A<br>SW2       | -                | See entry above.  | 3014   |

Part 3 – Dangerous Goods List, special provisions and exceptions

Chapter 3.2 – Dangerous Goods List

| UN No. | Proper shipping name (PSN)  | Class or division | Subsidiary hazard(s) | Packing group  | Special provisions | Limited and excepted quantity provisions |                     | Packing      |              | IBC           |               |
|--------|---|-------------------|----------------------|----------------|--------------------|--|---------------------|--------------|--------------|---------------|---------------|
|        |   |                   |                      |                |                    | Limited quantities                       | Excepted quantities | Instructions | Provisions   | Instructions  | Provisions    |
| (1)    | (2)<br>3.1.2  | (3)<br>2.0        | (4)<br>2.0           | (5)<br>2.0.1.3 | (6)<br>3.3         | (7a)<br>3.4                              | (7b)<br>3.5         | (8)<br>4.1.4 | (9)<br>4.1.4 | (10)<br>4.1.4 | (11)<br>4.1.4 |
| 3015   | BIPYRIDILIUM PESTICIDE, LIQUID, TOXIC, FLAMMABLE, flashpoint not less than 23°C     | 6.1               | 3                    | I              | 61<br>274          | 0  | E5                  | P001         | -            | -             | -             |
| 3015   | BIPYRIDILIUM PESTICIDE, LIQUID, TOXIC, FLAMMABLE, flashpoint not less than 23°C     | 6.1               | 3                    | II             | 61<br>274          | 100 mL                                   | E4                  | P001         | -            | IBC02         | -             |
| 3015   | BIPYRIDILIUM PESTICIDE, LIQUID, TOXIC, FLAMMABLE, flashpoint not less than 23°C     | 6.1               | 3                    | III            | 61<br>223<br>274   | 5 L                                      | E1                  | P001         | -            | IBC03         | -             |
| 3016   | BIPYRIDILIUM PESTICIDE, LIQUID, TOXIC   | 6.1               | -                    | I              | 61<br>274          | 0  | E5                  | P001         | -            | -             | -             |
| 3016   | BIPYRIDILIUM PESTICIDE, LIQUID, TOXIC   | 6.1               | -                    | II             | 61<br>274          | 100 mL                                   | E4                  | P001         | -            | IBC02         | -             |
| 3016   | BIPYRIDILIUM PESTICIDE, LIQUID, TOXIC   | 6.1               | -                    | III            | 61<br>223<br>274   | 5 L                                      | E1                  | P001<br>LP01 | -            | IBC03         | -             |
| 3017   | ORGANOPHOSPHORUS PESTICIDE, LIQUID, TOXIC, FLAMMABLE, flashpoint not less than 23°C | 6.1               | 3                    | I              | 61<br>274          | 0  | E5                  | P001         | -            | -             | -             |
| 3017   | ORGANOPHOSPHORUS PESTICIDE, LIQUID, TOXIC, FLAMMABLE, flashpoint not less than 23°C | 6.1               | 3                    | II             | 61<br>274          | 100 mL                                   | E4                  | P001         | -            | IBC02         | -             |
| 3017   | ORGANOPHOSPHORUS PESTICIDE, LIQUID, TOXIC, FLAMMABLE, flashpoint not less than 23°C | 6.1               | 3                    | III            | 61<br>223<br>274   | 5 L                                      | E1                  | P001         | -            | IBC03         | -             |
| 3018   | ORGANOPHOSPHORUS PESTICIDE, LIQUID, TOXIC   | 6.1               | -                    | I              | 61<br>274          | 0  | E5                  | P001         | -            | -             | -             |
| 3018   | ORGANOPHOSPHORUS PESTICIDE, LIQUID, TOXIC   | 6.1               | -                    | II             | 61<br>274          | 100 mL                                   | E4                  | P001         | -            | IBC02         | -             |
| 3018   | ORGANOPHOSPHORUS PESTICIDE, LIQUID, TOXIC   | 6.1               | -                    | III            | 61<br>223<br>274   | 5 L                                      | E1                  | P001<br>LP01 | -            | IBC03         | -             |
| 3019   | ORGANOTIN PESTICIDE, LIQUID, TOXIC, FLAMMABLE, flashpoint not less than 23°C        | 6.1               | 3<br>P               | I              | 61<br>274          | 0  | E5                  | P001         | -            | -             | -             |
| 3019   | ORGANOTIN PESTICIDE, LIQUID, TOXIC, FLAMMABLE, flashpoint not less than 23°C        | 6.1               | 3<br>P               | II             | 61<br>274          | 100 mL                                   | E4                  | P001         | -            | IBC02         | -             |
| 3019   | ORGANOTIN PESTICIDE, LIQUID, TOXIC, FLAMMABLE, flashpoint not less than 23°C        | 6.1               | 3<br>P               | III            | 61<br>223<br>274   | 5 L                                      | E1                  | P001         | -            | IBC03         | -             |
| 3020   | ORGANOTIN PESTICIDE, LIQUID, TOXIC  | 6.1               | -<br>P               | I              | 61<br>274          | 0  | E5                  | P001         | -            | -             | -             |

| UN No. | Portable tanks and bulk containers |                     | EmS                    | Stowage and handling    | Segregation      | Properties and observations   | UN No. |
|--------|------------------------------------|---------------------|------------------------|-------------------------|------------------|---|--------|
|        | Tank instructions                  | Provisions          |                        |                         |                  |   |        |
| (12)   | (13)<br>4.2.5<br>4.3               | (14)<br>4.2.5       | (15)<br>5.4.3.4<br>7.8 | (16a)<br>7.1<br>7.3-7.7 | (16b)<br>7.2-7.7 | (17)  | (18)   |
| -      | T14                                | TP2<br>TP13<br>TP27 | F-E, S-D               | Category B<br>SW2       | -                | Liquid flammable pesticides having a flashpoint between 23°C and 60°C c.c., presenting a very wide range of toxic hazard. They frequently contain petroleum or coal tar distillates, or other flammable liquids. Flashpoint and miscibility with water depend upon the composition. Toxic if swallowed, by skin contact or by inhalation. | 3015   |
| -      | T11                                | TP2<br>TP13<br>TP27 | F-E, S-D               | Category B<br>SW2       | -                | See entry above.  | 3015   |
| -      | T7                                 | TP2<br>TP28         | F-E, S-D               | Category A<br>SW2       | -                | See entry above.  | 3015   |
| -      | T14                                | TP2<br>TP13<br>TP27 | F-A, S-A               | Category B<br>SW2       | -                | Liquid pesticides which present a very wide range of toxic hazard. Miscibility with water depends upon the composition. Toxic if swallowed, by skin contact or by inhalation.   | 3016   |
| -      | T11                                | TP2<br>TP13<br>TP27 | F-A, S-A               | Category B<br>SW2       | -                | See entry above.  | 3016   |
| -      | T7                                 | TP2<br>TP28         | F-A, S-A               | Category A<br>SW2       | -                | See entry above.  | 3016   |
| -      | T14                                | TP2<br>TP13<br>TP27 | F-E, S-D               | Category B<br>SW2       | -                | Liquid flammable pesticides having a flashpoint between 23°C and 60°C c.c., presenting a very wide range of toxic hazard. They frequently contain petroleum or coal tar distillates, or other flammable liquids. Flashpoint and miscibility with water depend upon the composition. Toxic if swallowed, by skin contact or by inhalation. | 3017   |
| -      | T11                                | TP2<br>TP13<br>TP27 | F-E, S-D               | Category B<br>SW2       | -                | See entry above.  | 3017   |
| -      | T7                                 | TP2<br>TP28         | F-E, S-D               | Category A<br>SW2       | -                | See entry above.  | 3017   |
| -      | T14                                | TP2<br>TP13<br>TP27 | F-A, S-A               | Category B<br>SW2       | -                | Liquid pesticides which present a very wide range of toxic hazard. Miscibility with water depends upon the composition. Toxic if swallowed, by skin contact or by inhalation.   | 3018   |
| -      | T11                                | TP2<br>TP13<br>TP27 | F-A, S-A               | Category B<br>SW2       | -                | See entry above.  | 3018   |
| -      | T7                                 | TP2<br>TP28         | F-A, S-A               | Category A<br>SW2       | -                | See entry above.  | 3018   |
| -      | T14                                | TP2<br>TP13<br>TP27 | F-E, <u>S-D</u>        | Category B<br>SW2       | -                | Liquid flammable pesticides having a flashpoint between 23°C and 60°C c.c., presenting a very wide range of toxic hazard. They frequently contain petroleum or coal tar distillates, or other flammable liquids. Flashpoint and miscibility with water depend upon the composition. Toxic if swallowed, by skin contact or by inhalation. | 3019   |
| -      | T11                                | TP2<br>TP13<br>TP27 | F-E, <u>S-D</u>        | Category B<br>SW2       | -                | See entry above.  | 3019   |
| -      | T7                                 | TP2<br>TP28         | F-E, <u>S-D</u>        | Category A<br>SW2       | -                | See entry above.  | 3019   |
| -      | T14                                | TP2<br>TP13<br>TP27 | F-A, <u>S-A</u>        | Category B<br>SW2       | -                | Liquid pesticides which present a very wide range of toxic hazard. Miscibility with water depends upon the composition. Toxic if swallowed, by skin contact or by inhalation.   | 3020   |



Part 3 – Dangerous Goods List, special provisions and exceptions

Chapter 3.2 – Dangerous Goods List

| UN No. | Proper shipping name (PSN)   | Class or division | Subsidiary hazard(s) | Packing group  | Special provisions | Limited and excepted quantity provisions |                     | Packing      |              | IBC           |               |
|--------|--|-------------------|----------------------|----------------|--------------------|--|---------------------|--------------|--------------|---------------|---------------|
|        |  |                   |                      |                |                    | Limited quantities                       | Excepted quantities | Instructions | Provisions   | Instructions  | Provisions    |
| (1)    | (2)<br>3.1.2   | (3)<br>2.0        | (4)<br>2.0           | (5)<br>2.0.1.3 | (6)<br>3.3         | (7a)<br>3.4                              | (7b)<br>3.5         | (8)<br>4.1.4 | (9)<br>4.1.4 | (10)<br>4.1.4 | (11)<br>4.1.4 |
| 3020   | ORGANOTIN PESTICIDE, LIQUID, TOXIC   | 6.1               | -<br>P               | II             | 61<br>274          | 100 mL                                   | E4                  | P001         | -            | IBC02         | -             |
| 3020   | ORGANOTIN PESTICIDE, LIQUID, TOXIC   | 6.1               | -<br>P               | III            | 61<br>223<br>274   | 5 L                                      | E1                  | P001<br>LP01 | -            | IBC03         | -             |
| 3021   | PESTICIDE, LIQUID, FLAMMABLE, TOXIC, N.O.S., flashpoint less than 23°C                 | 3                 | 6.1                  | I              | 61<br>274          | 0  | E0                  | P001         | -            | -             | -             |
| 3021   | PESTICIDE, LIQUID, FLAMMABLE, TOXIC, N.O.S., flashpoint less than 23°C                 | 3                 | 6.1                  | II             | 61<br>274          | 1 L                                      | E2                  | P001         | -            | IBC02         | -             |
| 3022   | 1,2-BUTYLENE OXIDE, STABILIZED   | 3                 | -                    | II             | 386                | 1 L                                      | E2                  | P001         | -            | IBC02         | -             |
| 3023   | 2-METHYL-2-HEPTANETHIOL  | 6.1               | 3                    | I              | 354                | 0  | E0                  | P602         | -            | -             | -             |
| 3024   | COUMARIN DERIVATIVE PESTICIDE, LIQUID, FLAMMABLE, TOXIC, flashpoint less than 23°C     | 3                 | 6.1                  | I              | 61<br>274          | 0  | E0                  | P001         | -            | -             | -             |
| 3024   | COUMARIN DERIVATIVE PESTICIDE, LIQUID, FLAMMABLE, TOXIC, flashpoint less than 23°C     | 3                 | 6.1                  | II             | 61<br>274          | 1 L                                      | E2                  | P001         | -            | IBC02         | -             |
| 3025   | COUMARIN DERIVATIVE PESTICIDE, LIQUID, TOXIC, FLAMMABLE, flashpoint not less than 23°C | 6.1               | 3                    | I              | 61<br>274          | 0  | E5                  | P001         | -            | -             | -             |
| 3025   | COUMARIN DERIVATIVE PESTICIDE, LIQUID, TOXIC, FLAMMABLE, flashpoint not less than 23°C | 6.1               | 3                    | II             | 61<br>274          | 100 mL                                   | E4                  | P001         | -            | IBC02         | -             |
| 3025   | COUMARIN DERIVATIVE PESTICIDE, LIQUID, TOXIC, FLAMMABLE, flashpoint not less than 23°C | 6.1               | 3                    | III            | 61<br>223<br>274   | 5 L                                      | E1                  | P001         | -            | IBC03         | -             |
| 3026   | COUMARIN DERIVATIVE PESTICIDE, LIQUID, TOXIC   | 6.1               | -                    | I              | 61<br>274          | 0  | E5                  | P001         | -            | -             | -             |
| 3026   | COUMARIN DERIVATIVE PESTICIDE, LIQUID, TOXIC   | 6.1               | -                    | II             | 61<br>274          | 100 mL                                   | E4                  | P001         | -            | IBC02         | -             |
| 3026   | COUMARIN DERIVATIVE PESTICIDE, LIQUID, TOXIC   | 6.1               | -                    | III            | 61<br>223<br>274   | 5 L                                      | E1                  | P001<br>LP01 | -            | IBC03         | -             |
| 3027   | COUMARIN DERIVATIVE PESTICIDE, SOLID, TOXIC  | 6.1               | -                    | I              | 61<br>274          | 0  | E5                  | P002         | -            | IBC07         | B1            |
| 3027   | COUMARIN DERIVATIVE PESTICIDE, SOLID, TOXIC  | 6.1               | -                    | II             | 61<br>274          | 500 g                                    | E4                  | P002         | -            | IBC08         | B4<br>B21     |
| 3027   | COUMARIN DERIVATIVE PESTICIDE, SOLID, TOXIC  | 6.1               | -                    | III            | 61<br>223<br>274   | 5 kg                                     | E1                  | P002<br>LP02 | -            | IBC08         | B3            |

| UN No. | Portable tanks and bulk containers |                     | EmS                    | Stowage and handling    | Segregation      | Properties and observations   | UN No. |
|--------|------------------------------------|---------------------|------------------------|-------------------------|------------------|---|--------|
|        | Tank instructions                  | Provisions          |                        |                         |                  |   |        |
| (12)   | (13)<br>4.2.5<br>4.3               | (14)<br>4.2.5       | (15)<br>5.4.3.4<br>7.8 | (16a)<br>7.1<br>7.3-7.7 | (16b)<br>7.2-7.7 | (17)  | (18)   |
| -      | T11                                | TP2<br>TP13<br>TP27 | F-A, S-A               | Category B<br>SW2       | -                | Liquid pesticides which present a very wide range of toxic hazard. Miscibility with water depends upon the composition. Toxic if swallowed, by skin contact or by inhalation.   | 3020   |
| -      | T7                                 | TP2<br>TP28         | F-A, S-A               | Category A<br>SW2       | -                | See entry above.  | 3020   |
| -      | T14                                | TP2<br>TP13<br>TP27 | F-E, S-D               | Category B<br>SW2       | -                | Pesticides frequently contain petroleum or coal tar distillates, or other flammable liquids. Miscibility with water depends upon the composition. Toxic if swallowed, by skin contact or by inhalation.   | 3021   |
| -      | T11                                | TP2<br>TP13<br>TP27 | F-E, S-D               | Category B<br>SW2       | -                | See entry above.  | 3021   |
| -      | T4                                 | TP1                 | F-E, S-D               | Category C<br>SW1       | SG20<br>SG21     | Colourless liquid. Flashpoint: -15°C c.c. Explosive limits: 1.5% to 18.3%. Reacts violently with acids, alkalis and oxidizers. Miscible with water. Harmful if swallowed or by inhalation. Irritating to skin, eyes and mucous membranes.   | 3022   |
| -      | T20                                | TP2<br>TP13         | F-E, S-D               | Category D<br>SW2       | SG57             | Colourless flammable liquid with a foul odour. Flashpoint: 31°C c.c. Miscible with water. Highly toxic if swallowed, by skin contact or by inhalation.  | 3023   |
| -      | T14                                | TP2<br>TP13<br>TP27 | F-E, S-D               | Category B<br>SW2       | -                | Pesticides frequently contain petroleum or coal tar distillates, or other flammable liquids. Miscibility with water depends upon the composition. Toxic if swallowed, by skin contact or by inhalation.   | 3024   |
| -      | T11                                | TP2<br>TP13<br>TP27 | F-E, S-D               | Category B<br>SW2       | -                | See entry above.  | 3024   |
| -      | T14                                | TP2<br>TP13<br>TP27 | F-E, S-D               | Category B<br>SW2       | -                | Liquid flammable pesticides having a flashpoint between 23°C and 60°C c.c., presenting a very wide range of toxic hazard. They frequently contain petroleum or coal tar distillates, or other flammable liquids. Flashpoint and miscibility with water depend upon the composition. Toxic if swallowed, by skin contact or by inhalation. | 3025   |
| -      | T11                                | TP2<br>TP13<br>TP27 | F-E, S-D               | Category B<br>SW2       | -                | See entry above.  | 3025   |
| -      | T7                                 | TP1<br>TP28         | F-E, S-D               | Category A<br>SW2       | -                | See entry above.  | 3025   |
| -      | T14                                | TP2<br>TP13<br>TP27 | F-A, S-A               | Category B<br>SW2       | -                | Liquid pesticides which present a very wide range of toxic hazard. Miscibility with water depends upon the composition. Toxic if swallowed, by skin contact or by inhalation.   | 3026   |
| -      | T11                                | TP2<br>TP27         | F-A, S-A               | Category B<br>SW2       | -                | See entry above.  | 3026   |
| -      | T7                                 | TP1<br>TP28         | F-A, S-A               | Category A<br>SW2       | -                | See entry above.  | 3026   |
| -      | T6                                 | TP33                | F-A, S-A               | Category A<br>SW2       | -                | Solid pesticides present a very wide range of toxic hazard. Toxic if swallowed, by skin contact or by inhalation.   | 3027   |
| -      | T3                                 | TP33                | F-A, S-A               | Category A<br>SW2       | -                | See entry above.  | 3027   |
| -      | T1                                 | TP33                | F-A, S-A               | Category A<br>SW2       | -                | See entry above.  | 3027   |

Part 3 – Dangerous Goods List, special provisions and exceptions

Chapter 3.2 – Dangerous Goods List

| UN No. | Proper shipping name (PSN)   | Class or division | Subsidiary hazard(s) | Packing group  | Special provisions | Limited and excepted quantity provisions |                     | Packing      |              | IBC           |               |
|--------|--|-------------------|----------------------|----------------|--------------------|--|---------------------|--------------|--------------|---------------|---------------|
|        |  |                   |                      |                |                    | Limited quantities                       | Excepted quantities | Instructions | Provisions   | Instructions  | Provisions    |
| (1)    | (2)<br>3.1.2   | (3)<br>2.0        | (4)<br>2.0           | (5)<br>2.0.1.3 | (6)<br>3.3         | (7a)<br>3.4                              | (7b)<br>3.5         | (8)<br>4.1.4 | (9)<br>4.1.4 | (10)<br>4.1.4 | (11)<br>4.1.4 |
| 3028   | BATTERIES, DRY, CONTAINING POTASSIUM HYDROXIDE, SOLID electric storage   | 8                 | –                    | III            | 295<br>304         | 5 kg                                     | E0                  | P801         | –            | –             | –             |
| 3048   | ALUMINIUM PHOSPHIDE PESTICIDE  | 6.1               | –                    | I              | 153<br>930         | 0  | E0                  | P002         | PP31         | IBC07         | B1            |
| 3054   | CYCLOHEXYL MERCAPTAN   | 3                 | –                    | III            | –                  | 5 L                                      | E1                  | P001<br>LP01 | –            | IBC03         | –             |
| 3055   | 2-(2-AMINOETHOXY)ETHANOL   | 8                 | –                    | III            | –                  | 5 L                                      | E1                  | P001<br>LP01 | –            | IBC03         | –             |
| 3056   | n-HEPTALDEHYDE   | 3                 | –                    | III            | –                  | 5 L                                      | E1                  | P001<br>LP01 | –            | IBC03         | –             |
| 3057   | TRIFLUOROACETYL CHLORIDE   | 2.3               | 8                    | –              | –                  | 0  | E0                  | P200         | –            | –             | –             |
| △ 3064 | NITROGLYCERIN SOLUTION IN ALCOHOL with more than 1% but not more than 5% nitroglycerin   | 3                 | –                    | II             | 28<br>359          | 0  | E0                  | P300         | –            | –             | –             |
| 3065   | ALCOHOLIC BEVERAGES, with more than 70% alcohol by volume  | 3                 | –                    | II             | –                  | 5 L                                      | E2                  | P001         | PP2          | IBC02         | –             |
| 3065   | ALCOHOLIC BEVERAGES, with more than 24% but not more than 70% alcohol by volume  | 3                 | –                    | III            | 144<br>145<br>247  | 5 L                                      | E1                  | P001         | PP2          | IBC03         | –             |
| 3066   | PAINT (including paint, lacquer, enamel, stain, shellac, varnish, polish, liquid filler and liquid lacquer base) or PAINT RELATED MATERIAL (including paint thinning or reducing compound) | 8                 | –                    | II             | 163<br>367         | 1 L                                      | E2                  | P001         | –            | IBC02         | –             |

| UN No. | Portable tanks and bulk containers |               | EmS                    | Stowage and handling     | Segregation      | Properties and observations   | UN No. |
|--------|------------------------------------|---------------|------------------------|--------------------------|------------------|---|--------|
|        | Tank instructions                  | Provisions    |                        |                          |                  |   |        |
| (12)   | (13)<br>4.2.5<br>4.3               | (14)<br>4.2.5 | (15)<br>5.4.3.4<br>7.8 | (16a)<br>7.1<br>7.3–7.7  | (16b)<br>7.2–7.7 | (17)  | (18)   |
| –      | –                                  | –             | F-A, S-B               | Category A               | SGG18<br>SG35    | Series of metal plates immersed in dry potassium hydroxide in a closed receptacle. When electrically charged, may cause fire through short-circuiting of terminals. Batteries need not be individually marked and labelled if the pallet bears the appropriate mark and label. Used batteries being transported for disposal or reclamation should be carefully checked prior to shipment to ensure the integrity of each battery and its suitability for transport. React violently with acids.  | 3028   |
| –      | T6                                 | TP33          | F-A, S-A               | Category E<br>SW2<br>SW5 | –                | Waxed pellets, adequately stabilized powder, tablets or crystals. Highly toxic if swallowed, by skin contact or by inhalation.  | 3048   |
| –      | T2                                 | TP1           | F-E, S-D               | Category A<br>SW2        | SG50<br>SG57     | Colourless liquid with a garlic-like odour. Flashpoint: 49°C c.c. Immiscible with water. Harmful by inhalation. Irritating to skin, eyes and mucous membranes.  | 3054   |
| –      | T4                                 | TP1           | F-A, S-B               | Category A               | SG35             | Colourless, slightly viscous liquid with a mild odour. Miscible with water. Harmful if swallowed or by inhalation. Corrosive to skin, eyes and mucous membranes.  | 3055   |
| –      | T2                                 | TP1           | F-E, S-D               | Category A               | –                | Colourless or pale yellow, oily liquid with a pungent odour. Flashpoint: 35°C to 45°C c.c. Explosive limits: 1.1% to 5.2%. Slightly soluble in water. Irritating to skin, eyes and mucous membranes.  | 3056   |
| –      | T50                                | TP21          | F-C, S-U               | Category D<br>SW2        | –                | Liquefied, non-flammable, toxic and corrosive gas. Reacts with water. Corrosive to glass and to most metals, including steel. Heavier than air (1.4 at 20°C). Highly irritating to skin, eyes and mucous membranes.   | 3057   |
| –      | –                                  | –             | F-E, S-D               | Category E               | –                | Immiscible with water. Ignites readily. When involved in a fire, evolves toxic nitrous fumes. Not explosive in this state but damage to, or leakage from, a package may allow solvent to evaporate and thus leave the nitroglycerin in an explosive state.  | △ 3064 |
| –      | T4                                 | TP1           | F-E, S-D               | Category A               | –                | Aqueous solutions of ethanol produced and supplied as alcoholic beverages. Miscible with water. Flashpoint: –13°C c.c. or greater.  | 3065   |
| –      | T2                                 | TP1           | F-E, S-D               | Category A               | –                | Alcoholic beverages containing more than 24% alcohol but not more than 70% by volume, when transported as part of the manufacturing process, may be transported in wooden barrels with a capacity of more than 250 L and not more than 500 L meeting the general requirements of 4.1.1, as appropriate, on the following conditions:<br>.1 the wooden barrels should be checked and tightened before filling;<br>.2 sufficient ullage (not less than 3%) should be left to allow for the expansion of the liquid;<br>.3 the wooden barrels should be transported with the bungholes pointing upwards;<br>.4 the wooden barrels should be transported in containers meeting the requirements of the <i>International Convention for Safe Containers, 1972</i> (CSC Convention), as amended. Each wooden barrel should be secured in custom-made cradles and should be wedged by appropriate means to prevent them from being displaced in any way during transport; and<br>.5 when carried on board ships, the containers should be stowed in open cargo spaces or in enclosed cargo spaces complying with the requirements for class 3 flammable liquids with a flashpoint of 23°C c.c. or less in regulation II-2/19 of SOLAS, 74, as amended. | 3065   |
| –      | T7                                 | TP2<br>TP28   | F-A, S-B               | Category B<br>SW2        | –                | Corrosive content. Causes burns to skin, eyes and mucous membranes.   | 3066   |

Part 3 – Dangerous Goods List, special provisions and exceptions

Chapter 3.2 – Dangerous Goods List

| UN No. | Proper shipping name (PSN)   | Class or division | Subsidiary hazard(s) | Packing group  | Special provisions                     | Limited and excepted quantity provisions |                     | Packing      |              | IBC           |               |
|--------|--|-------------------|----------------------|----------------|--|--|---------------------|--------------|--------------|---------------|---------------|
|        |  |                   |                      |                |  | Limited quantities                       | Excepted quantities | Instructions | Provisions   | Instructions  | Provisions    |
| (1)    | (2)<br>3.1.2   | (3)<br>2.0        | (4)<br>2.0           | (5)<br>2.0.1.3 | (6)<br>3.3                             | (7a)<br>3.4                              | (7b)<br>3.5         | (8)<br>4.1.4 | (9)<br>4.1.4 | (10)<br>4.1.4 | (11)<br>4.1.4 |
| 3066   | PAINT (including paint, lacquer, enamel, stain, shellac, varnish, polish, liquid filler and liquid lacquer base) or PAINT RELATED MATERIAL (including paint thinning or reducing compound) | 8                 | –                    | III            | 163<br>223<br>367                      | 5 L                                      | E1                  | P001         | –            | IBC03         | –             |
| 3070   | ETHYLENE OXIDE AND DICHLORODIFLUORO-METHANE MIXTURE with not more than 12.5% ethylene oxide  | 2.2               | –                    | –              | 392                                    | 120 mL                                   | E1                  | P200         | –            | –             | –             |
| 3071   | MERCAPTANS, LIQUID, TOXIC, FLAMMABLE, N.O.S. or MERCAPTAN MIXTURE, LIQUID, TOXIC, FLAMMABLE, N.O.S.  | 6.1               | 3                    | II             | 274                                    | 100 mL                                   | E4                  | P001         | –            | IBC02         | –             |
| 3072   | LIFE-SAVING APPLIANCES NOT SELF-INFLATING containing dangerous goods as equipment  | 9                 | –                    | –              | 296                                    | 0  | E0                  | P905         | –            | –             | –             |
| 3073   | VINYLPYRIDINES, STABILIZED   | 6.1               | 3/8                  | II             | 386                                    | 100 mL                                   | E4                  | P001         | –            | IBC01         | –             |
| △ 3077 | ENVIRONMENTALLY HAZARDOUS SUBSTANCE, SOLID, N.O.S.   | 9                 | –                    | III            | 274<br>335<br>375<br>966<br>967<br>969 | 5 kg                                     | E1                  | P002<br>LP02 | PP12         | IBC08         | B3            |
| 3078   | CERIUM, turnings or gritty powder  | 4.3               | –                    | II             | –                                      | 500 g                                    | E2                  | P410         | PP31<br>PP40 | IBC07         | B4<br>B21     |
| 3079   | METHACRYLONITRILE, STABILIZED  | 6.1               | 3                    | I              | 354<br>386                             | 0  | E0                  | P602         | –            | –             | –             |
| 3080   | ISOCYANATES, TOXIC, FLAMMABLE, N.O.S or ISOCYANATE SOLUTION, TOXIC, FLAMMABLE, N.O.S.  | 6.1               | 3                    | II             | 274                                    | 100 mL                                   | E4                  | P001         | –            | IBC02         | –             |
| △ 3082 | ENVIRONMENTALLY HAZARDOUS SUBSTANCE, LIQUID, N.O.S.  | 9                 | –                    | III            | 274<br>335<br>375<br>969               | 5 L                                      | E1                  | P001<br>LP01 | PP1          | IBC03         | –             |
| 3083   | PERCHLORYL FLUORIDE  | 2.3               | 5.1                  | –              | –                                      | 0  | E0                  | P200         | –            | –             | –             |
| 3084   | CORROSIVE SOLID, OXIDIZING, N.O.S.   | 8                 | 5.1                  | I              | 274                                    | 0  | E0                  | P002         | –            | –             | –             |
| 3084   | CORROSIVE SOLID, OXIDIZING, N.O.S.   | 8                 | 5.1                  | II             | 274                                    | 1 kg                                     | E2                  | P002         | –            | IBC06         | B21           |

| UN No. | Portable tanks and bulk containers |                     | EmS                    | Stowage and handling     | Segregation                 | Properties and observations   | UN No. |
|--------|------------------------------------|---------------------|------------------------|--------------------------|-----------------------------|---|--------|
|        | Tank instructions                  | Provisions          |                        |                          |                             |   |        |
| (12)   | (13)<br>4.2.5<br>4.3               | (14)<br>4.2.5       | (15)<br>5.4.3.4<br>7.8 | (16a)<br>7.1<br>7.3–7.7  | (16b)<br>7.2–7.7            | (17)  | (18)   |
| –      | T4                                 | TP1<br>TP29         | F-A, S-B               | Category A<br>SW2        | –                           | Corrosive content. Causes burns to skin, eyes and mucous membranes.   | 3066   |
| –      | T50                                | –                   | F-C, S-V               | Category A               | –                           | Liquefied, non-flammable gas. Much heavier than air.  | 3070   |
| –      | T11                                | TP2<br>TP13<br>TP27 | F-E, S-D               | Category C<br>SW2        | SG57                        | Colourless to yellow flammable liquids with a garlic odour. Immiscible with water. Toxic if swallowed, by skin contact or by inhalation.  | 3071   |
| –      | –                                  | –                   | F-A, S-V               | Category A               | SG18<br>SG71                | These articles may contain:<br>.1 class 2.2 compressed gases;<br>.2 signal devices (class 1) which may include smoke and illumination signal flares; signal devices must be packed in plastic or fibreboard inner packagings;<br>.3 electric storage batteries;<br>.4 first aid kit; or<br>.5 "strike anywhere" matches.                                    | 3072   |
| –      | T7                                 | TP2<br>TP13         | F-E, S-C               | Category C<br>SW1<br>SW2 | SGG18<br>SG5<br>SG8<br>SG35 | Colourless to straw-coloured flammable liquids. Flashpoint: 42°C to 51°C c.c. Toxic if swallowed, by skin contact or by inhalation. Cause burns to skin, eyes and mucous membranes. React violently with acids.   | 3073   |
| –      | T1<br>BK1<br>BK2<br>BK3            | TP33                | F-A, S-F               | Category A<br>SW23       | –                           | –   | 3077 △ |
| –      | T3                                 | TP33                | F-G, S-O               | Category E<br>H1         | SGG15<br>SG26<br>SG35       | Grey, ductile metal or powder. Decomposes in water and reacts violently with acids, evolving hydrogen, which may be ignited by the heat of the reaction.  | 3078   |
| –      | T20                                | TP2<br>TP13         | F-E, S-D               | Category D<br>SW1<br>SW2 | –                           | Colourless, mobile liquid with a pungent odour. Flashpoint: 4°C c.c. Explosive limits: 3% to 17%. Partially miscible with water. Highly toxic if swallowed, by skin contact or by inhalation. Practice has shown that this substance may leak from packagings that ordinarily are leakproof to other chemicals.   | 3079   |
| –      | T11                                | TP2<br>TP13<br>TP27 | F-E, S-D               | Category D<br>SW1<br>SW2 | –                           | Flammable liquids or solutions with a pungent odour. Immiscible with or insoluble in water, but react with it to form carbon dioxide. Toxic if swallowed, by skin contact or by inhalation. Irritating to skin, eyes and mucous membranes.  | 3080   |
| –      | T4                                 | TP1<br>TP29         | F-A, S-F               | Category A               | –                           | –   | 3082 △ |
| –      | –                                  | –                   | F-C, S-W               | Category D<br>SW2        | –                           | Non-flammable, toxic, colourless gas with a characteristic sweet odour. Strong oxidizing agent; may cause fire in contact with organic materials. Reacts with water or moist air to produce toxic and corrosive fumes. Mixtures with oils or combustible materials may explode. Much heavier than air (3.6). Irritating to skin, eyes and mucous membranes. | 3083   |
| –      | T6                                 | TP33                | F-A, S-Q               | Category C               | –                           | Causes burns to skin, eyes and mucous membranes.  | 3084   |
| –      | T3                                 | TP33                | F-A, S-Q               | Category C               | –                           | See entry above.  | 3084   |

Part 3 – Dangerous Goods List, special provisions and exceptions

Chapter 3.2 – Dangerous Goods List

| UN No. | Proper shipping name (PSN)  | Class or division | Subsidiary hazard(s) | Packing group  | Special provisions  | Limited and excepted quantity provisions |                     | Packing  |              | IBC           |               |
|--------|---|-------------------|----------------------|----------------|---|--|---------------------|--|--------------|---------------|---------------|
|        |   |                   |                      |                |   | Limited quantities                       | Excepted quantities | Instructions   | Provisions   | Instructions  | Provisions    |
| (1)    | (2)<br>3.1.2  | (3)<br>2.0        | (4)<br>2.0           | (5)<br>2.0.1.3 | (6)<br>3.3  | (7a)<br>3.4                              | (7b)<br>3.5         | (8)<br>4.1.4   | (9)<br>4.1.4 | (10)<br>4.1.4 | (11)<br>4.1.4 |
| 3085   | OXIDIZING SOLID, CORROSIVE, N.O.S.  | 5.1               | 8                    | I              | 274   | 0  | E0                  | P503   | -            | -             | -             |
| 3085   | OXIDIZING SOLID, CORROSIVE, N.O.S.  | 5.1               | 8                    | II             | 274   | 1 kg                                     | E2                  | P002   | -            | IBC06         | B21           |
| 3085   | OXIDIZING SOLID, CORROSIVE, N.O.S.  | 5.1               | 8                    | III            | 223<br>274  | 5 kg                                     | E1                  | P002   | -            | IBC08         | B3            |
| 3086   | TOXIC SOLID, OXIDIZING, N.O.S.  | 6.1               | 5.1                  | I              | 274   | 0  | E5                  | P002   | -            | -             | -             |
| 3086   | TOXIC SOLID, OXIDIZING, N.O.S.  | 6.1               | 5.1                  | II             | 274   | 500 g                                    | E4                  | P002   | -            | IBC06         | B21           |
| 3087   | OXIDIZING SOLID, TOXIC, N.O.S.  | 5.1               | 6.1                  | I              | 274<br>900  | 0  | E0                  | P503   | -            | -             | -             |
| 3087   | OXIDIZING SOLID, TOXIC, N.O.S.  | 5.1               | 6.1                  | II             | 274<br>900  | 1 kg                                     | E2                  | P002   | -            | IBC06         | B21           |
| 3087   | OXIDIZING SOLID, TOXIC, N.O.S.  | 5.1               | 6.1                  | III            | 223<br>274<br>900   | 5 kg                                     | E1                  | P002   | -            | IBC08         | B3            |
| 3088   | SELF-HEATING SOLID, ORGANIC, N.O.S.   | 4.2               | -                    | II             | 274   | 0  | E2                  | P410   | PP31         | IBC06         | B21           |
| 3088   | SELF-HEATING SOLID, ORGANIC, N.O.S.   | 4.2               | -                    | III            | 223<br>274  | 0  | E1                  | P002<br>LP02   | PP31         | IBC08         | B3            |
| 3089   | METAL POWDER, FLAMMABLE, N.O.S.   | 4.1               | -                    | II             | -   | 1 kg                                     | E2                  | P002   | PP100        | IBC08         | B4<br>B21     |
| 3089   | METAL POWDER, FLAMMABLE, N.O.S.   | 4.1               | -                    | III            | 223   | 5 kg                                     | E1                  | P002   | PP100        | IBC08         | B4<br>B21     |
| △ 3090 | LITHIUM METAL BATTERIES (including lithium alloy batteries)   | 9                 | -                    | -              | 188<br>230<br>310<br>376<br>377<br>384<br>387               | 0  | E0                  | P903<br>P908<br>P909<br>P910<br>P911<br>LP903<br>LP904<br>LP905<br>LP906 | -            | -             | -             |
| △ 3091 | LITHIUM METAL BATTERIES CONTAINED IN EQUIPMENT or LITHIUM METAL BATTERIES PACKED WITH EQUIPMENT (including lithium alloy batteries) | 9                 | -                    | -              | 188<br>230<br>310<br>360<br>376<br>377<br>384<br>387<br>390 | 0  | E0                  | P903<br>P908<br>P909<br>P910<br>P911<br>LP903<br>LP904<br>LP905<br>LP906 | -            | -             | -             |
| 3092   | 1-METHOXY-2-PROPANOL  | 3                 | -                    | III            | -   | 5 L                                      | E1                  | P001<br>LP01   | -            | IBC03         | -             |

| UN No. | Portable tanks and bulk containers |               | EmS                    | Stowage and handling    | Segregation                           | Properties and observations  | UN No. |
|--------|------------------------------------|---------------|------------------------|-------------------------|---------------------------------------|--|--------|
|        | Tank instructions                  | Provisions    |                        |                         |                                       |  |        |
| (12)   | (13)<br>4.2.5<br>4.3               | (14)<br>4.2.5 | (15)<br>5.4.3.4<br>7.8 | (16a)<br>7.1<br>7.3-7.7 | (16b)<br>7.2-7.7                      | (17)   | (18)   |
| -      | -                                  | -             | F-A, S-Q               | Category D H1           | SG38<br>SG49<br>SG60                  | Causes burns to skin, eyes and mucous membranes. Particular care in handling should be exercised if packages have become wetted.   | 3085   |
| -      | T3                                 | TP33          | F-A, S-Q               | Category B H1           | SG38<br>SG49<br>SG60                  | See entry above.   | 3085   |
| -      | T1                                 | TP33          | F-A, S-Q               | Category B H1           | SG38<br>SG49<br>SG60                  | See entry above.   | 3085   |
| -      | T6                                 | TP33          | F-A, S-Q               | Category C              | -                                     | Toxic if swallowed, by skin contact or by inhalation.  | 3086   |
| -      | T3                                 | TP33          | F-A, S-Q               | Category C              | -                                     | See entry above.   | 3086   |
| -      | -                                  | -             | F-A, S-Q               | Category D              | SG38<br>SG49<br>SG60                  | Toxic if swallowed, by skin contact or by dust inhalation. Should be handled with care to minimize exposure, particularly to dust.   | 3087   |
| -      | T3                                 | TP33          | F-A, S-Q               | Category B              | SG38<br>SG49<br>SG60                  | See entry above.   | 3087   |
| -      | T1                                 | TP33          | F-A, S-Q               | Category B              | SG38<br>SG49<br>SG60                  | See entry above.   | 3087   |
| -      | T3                                 | TP33          | F-A, S-J               | Category C              | -                                     | Liable to self-heating or spontaneous combustion.  | 3088   |
| -      | T1                                 | TP33          | F-A, S-J               | Category C              | -                                     | See entry above.   | 3088   |
| -      | T3                                 | TP33          | F-G, S-G               | Category B H1           | SGG7<br>SGG15<br>SG17<br>SG25<br>SG26 | -  | 3089   |
| -      | T1                                 | TP33          | F-G, S-G               | Category A H1           | SGG7<br>SGG15<br>SG17<br>SG25<br>SG26 | -  | 3089   |
| -      | -                                  | -             | F-A, S-I               | Category A SW19         | -                                     | Electrical batteries containing lithium metal may react (e.g. flame, heat, emission of toxic, corrosive or flammable gases or vapours) or disassemble due to damage, defects or short circuit. | 3090 △ |
| -      | -                                  | -             | F-A, S-I               | Category A SW19         | -                                     | Electrical batteries containing lithium metal may react (e.g. flame, heat, emission of toxic, corrosive or flammable gases or vapours) or disassemble due to damage, defects or short circuit. | 3091 △ |
| -      | T2                                 | TP1           | F-E, S-D               | Category A              | -                                     | Colourless liquid. Flashpoint: 29°C to 35°C c.c. Explosive limits: 1.7% to 11.5%. Miscible with water. Reacts with strong oxidizing substances. Irritating to skin, eyes and mucous membranes. | 3092   |



Part 3 – Dangerous Goods List, special provisions and exceptions

Chapter 3.2 – Dangerous Goods List

| UN No. | Proper shipping name (PSN)               | Class or division | Subsidiary hazard(s) | Packing group  | Special provisions       | Limited and excepted quantity provisions |                     | Packing      |              | IBC           |               |
|--------|--|-------------------|----------------------|----------------|--------------------------|--|---------------------|--------------|--------------|---------------|---------------|
|        |  |                   |                      |                |                          | Limited quantities                       | Excepted quantities | Instructions | Provisions   | Instructions  | Provisions    |
| (1)    | (2)<br>3.1.2                             | (3)<br>2.0        | (4)<br>2.0           | (5)<br>2.0.1.3 | (6)<br>3.3               | (7a)<br>3.4                              | (7b)<br>3.5         | (8)<br>4.1.4 | (9)<br>4.1.4 | (10)<br>4.1.4 | (11)<br>4.1.4 |
| 3093   | CORROSIVE LIQUID, OXIDIZING, N.O.S.      | 8                 | 5.1                  | I              | 274                      | 0  | E0                  | P001         | -            | -             | -             |
| 3093   | CORROSIVE LIQUID, OXIDIZING, N.O.S.      | 8                 | 5.1                  | II             | 274                      | 1 L                                      | E2                  | P001         | -            | IBC02         | -             |
| 3094   | CORROSIVE LIQUID, WATER-REACTIVE, N.O.S. | 8                 | 4.3                  | I              | 274                      | 0  | E0                  | P001         | -            | -             | -             |
| 3094   | CORROSIVE LIQUID, WATER-REACTIVE, N.O.S. | 8                 | 4.3                  | II             | 274                      | 500 mL                                   | E2                  | P001         | -            | -             | -             |
| 3095   | CORROSIVE SOLID, SELF-HEATING, N.O.S.    | 8                 | 4.2                  | I              | 274                      | 0  | E0                  | P002         | -            | -             | -             |
| 3095   | CORROSIVE SOLID, SELF-HEATING, N.O.S.    | 8                 | 4.2                  | II             | 274                      | 1 kg                                     | E2                  | P002         | -            | IBC06         | B21           |
| 3096   | CORROSIVE SOLID, WATER-REACTIVE, N.O.S.  | 8                 | 4.3                  | I              | 274                      | 0  | E0                  | P002         | -            | -             | -             |
| 3096   | CORROSIVE SOLID, WATER-REACTIVE, N.O.S.  | 8                 | 4.3                  | II             | 274                      | 1 kg                                     | E2                  | P002         | PP100        | IBC06         | B21           |
| 3097   | FLAMMABLE SOLID, OXIDIZING, N.O.S.       | 4.1               | 5.1                  | II             | 274<br>976               | 0  | E0                  | P099         | -            | -             | -             |
| 3097   | FLAMMABLE SOLID, OXIDIZING, N.O.S.       | 4.1               | 5.1                  | III            | 274<br>976               | 0  | E0                  | P099         | -            | -             | -             |
| 3098   | OXIDIZING LIQUID, CORROSIVE, N.O.S.      | 5.1               | 8                    | I              | 274                      | 0  | E0                  | P502         | -            | -             | -             |
| 3098   | OXIDIZING LIQUID, CORROSIVE, N.O.S.      | 5.1               | 8                    | II             | 274                      | 1 L                                      | E2                  | P504         | -            | IBC01         | -             |
| 3098   | OXIDIZING LIQUID, CORROSIVE, N.O.S.      | 5.1               | 8                    | III            | 223<br>274               | 5 L                                      | E1                  | P504         | -            | IBC02         | -             |
| 3099   | OXIDIZING LIQUID, TOXIC, N.O.S.          | 5.1               | 6.1                  | I              | 274                      | 0  | E0                  | P502         | -            | -             | -             |
| 3099   | OXIDIZING LIQUID, TOXIC, N.O.S.          | 5.1               | 6.1                  | II             | 274                      | 1 L                                      | E2                  | P504         | -            | IBC01         | -             |
| 3099   | OXIDIZING LIQUID, TOXIC, N.O.S.          | 5.1               | 6.1                  | III            | 223<br>274               | 5 L                                      | E1                  | P504         | -            | IBC02         | -             |
| 3100   | OXIDIZING SOLID, SELF-HEATING, N.O.S.    | 5.1               | 4.2                  | I              | 274<br>976               | 0  | E0                  | P099         | -            | -             | -             |
| 3100   | OXIDIZING SOLID, SELF-HEATING, N.O.S.    | 5.1               | 4.2                  | II             | 274<br>976               | 0  | E0                  | P099         | -            | -             | -             |
| 3101   | ORGANIC PEROXIDE TYPE B, LIQUID          | 5.2               | See SP181            | -              | 122<br>181<br>195<br>274 | 25 mL                                    | E0                  | P520         | -            | -             | -             |
| 3102   | ORGANIC PEROXIDE TYPE B, SOLID           | 5.2               | See SP181            | -              | 122<br>181<br>195<br>274 | 100 g                                    | E0                  | P520         | -            | -             | -             |
| 3103   | ORGANIC PEROXIDE TYPE C, LIQUID          | 5.2               | -                    | -              | 122<br>195<br>274        | 25 mL                                    | E0                  | P520         | -            | -             | -             |

| UN No. | Portable tanks and bulk containers |               | EmS                    | Stowage and handling    | Segregation                 | Properties and observations   | UN No. |
|--------|------------------------------------|---------------|------------------------|-------------------------|-----------------------------|---|--------|
|        | Tank instructions                  | Provisions    |                        |                         |                             |   |        |
| (12)   | (13)<br>4.2.5<br>4.3               | (14)<br>4.2.5 | (15)<br>5.4.3.4<br>7.8 | (16a)<br>7.1<br>7.3-7.7 | (16b)<br>7.2-7.7            | (17)  | (18)   |
| -      | -                                  | -             | F-A, S-Q               | Category C              | -                           | Causes burns to skin, eyes and mucous membranes.  | 3093   |
| -      | -                                  | -             | F-A, S-Q               | Category C              | -                           | See entry above.  | 3093   |
| -      | -                                  | -             | F-G, S-L               | Category D H1           | SG26                        | Causes burns to skin, eyes and mucous membranes.  | 3094   |
| -      | -                                  | -             | F-G, S-L               | Category D H1           | SG26                        | See entry above.  | 3094   |
| -      | T6                                 | TP33          | F-A, S-N               | Category D              | -                           | Causes burns to skin, eyes and mucous membranes.  | 3095   |
| -      | T3                                 | TP33          | F-A, S-N               | Category D              | -                           | See entry above.  | 3095   |
| -      | T6                                 | TP33          | F-G, S-L               | Category D H1           | SG26                        | Causes burns to skin, eyes and mucous membranes.  | 3096   |
| -      | T3                                 | TP33          | F-G, S-L               | Category D H1           | SG26                        | See entry above.  | 3096   |
| -      | -                                  | -             | F-A, S-Q               | -                       | -                           | -   | 3097   |
| -      | T1                                 | TP33          | F-A, S-Q               | -                       | -                           | -   | 3097   |
| -      | -                                  | -             | F-A, S-Q               | Category D H1           | SG38<br>SG49<br>SG60        | Causes burns to skin, eyes and mucous membranes. Particular care in handling should be exercised if packages have become wetted.  | 3098   |
| -      | -                                  | -             | F-A, S-Q               | Category B H1           | SG38<br>SG49<br>SG60        | See entry above.  | 3098   |
| -      | -                                  | -             | F-A, S-Q               | Category B H1           | SG38<br>SG49<br>SG60        | See entry above.  | 3098   |
| -      | -                                  | -             | F-A, S-Q               | Category D              | SG38<br>SG49<br>SG60        | Toxic if swallowed, by skin contact or by dust inhalation. Should be handled with care to minimize exposure, particularly to dust.  | 3099   |
| -      | -                                  | -             | F-A, S-Q               | Category B              | SG38<br>SG49<br>SG60        | See entry above.  | 3099   |
| -      | -                                  | -             | F-A, S-Q               | Category B              | SG38<br>SG49<br>SG60        | See entry above.  | 3099   |
| -      | -                                  | -             | F-A, S-Q               | -                       | -                           | -   | 3100   |
| -      | -                                  | -             | F-A, S-Q               | -                       | -                           | -   | 3100   |
| -      | -                                  | -             | F-J, S-R               | Category D SW1          | SG1<br>SG35<br>SG36<br>SG72 | May explode at elevated temperatures or in a fire. Burns vigorously. Immiscible with water. Contact with the eyes and skin should be avoided. May evolve irritant or toxic fumes.   | 3101   |
| -      | -                                  | -             | F-J, S-R               | Category D SW1          | SG1<br>SG35<br>SG36<br>SG72 | May explode at elevated temperatures or in a fire. Burns vigorously. Insoluble in water. Contact with the eyes and skin should be avoided. Addition of water to disuccinic acid peroxide will decrease its thermal stability. May evolve irritant or toxic fumes. | 3102   |
| -      | -                                  | -             | F-J, S-R               | Category D SW1          | SG35<br>SG36<br>SG72        | May decompose violently at elevated temperatures or in a fire. Burns vigorously. Immiscible with water except for <i>tert</i> -butyl hydroperoxide. Contact with the eyes and skin should be avoided. May evolve irritant or toxic fumes.                         | 3103   |

| UN No. | Proper shipping name (PSN)                              | Class or division | Subsidiary hazard(s) | Packing group  | Special provisions              | Limited and excepted quantity provisions |                     | Packing      |              | IBC           |               |
|--------|---|-------------------|----------------------|----------------|---------------------------------|--|---------------------|--------------|--------------|---------------|---------------|
|        |   |                   |                      |                |                                 | Limited quantities                       | Excepted quantities | Instructions | Provisions   | Instructions  | Provisions    |
| (1)    | (2)<br>3.1.2  | (3)<br>2.0        | (4)<br>2.0           | (5)<br>2.0.1.3 | (6)<br>3.3                      | (7a)<br>3.4                              | (7b)<br>3.5         | (8)<br>4.1.4 | (9)<br>4.1.4 | (10)<br>4.1.4 | (11)<br>4.1.4 |
| 3104   | ORGANIC PEROXIDE TYPE C, SOLID                          | 5.2               | –                    | –              | 122<br>195<br>274               | 100 g                                    | E0                  | P520         | –            | –             | –             |
| 3105   | ORGANIC PEROXIDE TYPE D, LIQUID                         | 5.2               | –                    | –              | 122<br>274                      | 125 mL                                   | E0                  | P520         | –            | –             | –             |
| 3106   | ORGANIC PEROXIDE TYPE D, SOLID                          | 5.2               | –                    | –              | 122<br>274                      | 500 g                                    | E0                  | P520         | –            | –             | –             |
| 3107   | ORGANIC PEROXIDE TYPE E, LIQUID                         | 5.2               | –                    | –              | 122<br>274                      | 125 mL                                   | E0                  | P520         | –            | –             | –             |
| 3108   | ORGANIC PEROXIDE TYPE E, SOLID                          | 5.2               | –                    | –              | 122<br>274                      | 500 g                                    | E0                  | P520         | –            | –             | –             |
| 3109   | ORGANIC PEROXIDE TYPE F, LIQUID                         | 5.2               | –                    | –              | 122<br>274                      | 125 mL                                   | E0                  | P520         | –            | IBC520        | –             |
| 3110   | ORGANIC PEROXIDE TYPE F, SOLID                          | 5.2               | –                    | –              | 122<br>274                      | 500 g                                    | E0                  | P520         | –            | IBC520        | –             |
| 3111   | ORGANIC PEROXIDE TYPE B, LIQUID, TEMPERATURE CONTROLLED | 5.2               | See SP181            | –              | 122<br>181<br>195<br>274<br>923 | 0  | E0                  | P520         | –            | –             | –             |
| 3112   | ORGANIC PEROXIDE TYPE B, SOLID, TEMPERATURE CONTROLLED  | 5.2               | See SP181            | –              | 122<br>181<br>195<br>274<br>923 | 0  | E0                  | P520         | –            | –             | –             |
| 3113   | ORGANIC PEROXIDE TYPE C, LIQUID, TEMPERATURE CONTROLLED | 5.2               | –                    | –              | 122<br>195<br>274<br>923        | 0  | E0                  | P520         | –            | –             | –             |
| 3114   | ORGANIC PEROXIDE TYPE C, SOLID, TEMPERATURE CONTROLLED  | 5.2               | –                    | –              | 122<br>195<br>274<br>923        | 0  | E0                  | P520         | –            | –             | –             |
| 3115   | ORGANIC PEROXIDE TYPE D, LIQUID, TEMPERATURE CONTROLLED | 5.2               | –                    | –              | 122<br>274<br>923               | 0  | E0                  | P520         | –            | –             | –             |

| UN No. | Portable tanks and bulk containers |               | EmS                    | Stowage and handling    | Segregation                 | Properties and observations   | UN No. |
|--------|------------------------------------|---------------|------------------------|-------------------------|-----------------------------|---|--------|
|        | Tank instructions                  | Provisions    |                        |                         |                             |   |        |
| (12)   | (13)<br>4.2.5<br>4.3               | (14)<br>4.2.5 | (15)<br>5.4.3.4<br>7.8 | (16a)<br>7.1<br>7.3–7.7 | (16b)<br>7.2–7.7            | (17)  | (18)   |
| –      | –                                  | –             | F-J, S-R               | Category D SW1          | SG35<br>SG36<br>SG72        | May decompose violently at elevated temperatures or in a fire. Burns vigorously. Insoluble in water. Contact with the eyes and skin should be avoided. May evolve irritant or toxic fumes.  | 3104   |
| –      | –                                  | –             | F-J, S-R               | Category D SW1          | SG35<br>SG36<br>SG72        | Decomposes at elevated temperatures or in a fire. Burns vigorously. Immiscible with water except for acetylacetone peroxide, <i>tert</i> -butyl hydroperoxide and peroxyacetic acid, Type D, stabilized. Contact with the eyes and skin should be avoided. May evolve irritant or toxic fumes.  | 3105   |
| –      | –                                  | –             | F-J, S-R               | Category D SW1          | SG35<br>SG36<br>SG72        | Decomposes at elevated temperatures or in a fire. Burns vigorously. Insoluble in water except for 3-chloroperoxybenzoic acid. Contact with the eyes and skin should be avoided. May evolve irritant or toxic fumes.   | 3106   |
| –      | –                                  | –             | F-J, S-R               | Category D SW1          | SG35<br>SG36<br>SG72        | Decomposes at elevated temperatures or in a fire. Burns vigorously. Immiscible with water except for <i>tert</i> -amyl hydroperoxide, and <i>tert</i> -butyl hydroperoxide and peroxyacetic acid, Type E, stabilized. Contact with the eyes and skin should be avoided. May evolve irritant or toxic fumes.   | 3107   |
| –      | –                                  | –             | F-J, S-R               | Category D SW1          | SG35<br>SG36<br>SG72        | Decomposes at elevated temperatures or in a fire. Burns vigorously. Insoluble in water. Contact with the eyes and skin should be avoided. May evolve irritant or toxic fumes.   | 3108   |
| –      | T23                                | –             | F-J, S-R               | Category D SW1          | SG35<br>SG36<br>SG72        | Decomposes at elevated temperatures or in a fire. Burns vigorously. Immiscible with water except for <i>tert</i> -butyl hydroperoxide; dibenzoyl peroxide; dilauroyl peroxide and peroxyacetic acid, Type F, stabilized. Contact with the eyes and skin should be avoided. May evolve irritant or toxic fumes.  | 3109   |
| –      | T23                                | TP33          | F-J, S-R               | Category D SW1          | SG35<br>SG36<br>SG72        | Decomposes at elevated temperatures or in a fire. Burns vigorously. Insoluble in water. Contact with the eyes and skin should be avoided. May evolve irritant or toxic fumes.   | 3110   |
| –      | –                                  | –             | F-F, S-R               | Category D SW1 SW3      | SG1<br>SG35<br>SG36<br>SG72 | May explode at temperatures higher than the emergency temperature or in a fire. Burns vigorously. Immiscible with water. Contact with the eyes and skin should be avoided. Control and emergency temperatures for each formulation are given in table 2.5.3.2.4. The temperature should be checked regularly. May evolve irritant or toxic fumes.             | 3111   |
| –      | –                                  | –             | F-F, S-R               | Category D SW1 SW3      | SG1<br>SG35<br>SG36<br>SG72 | May explode at temperatures higher than the emergency temperature or in a fire. Burns vigorously. Immiscible with water. Contact with the eyes and skin should be avoided. Control and emergency temperatures for each formulation are given in table 2.5.3.2.4. The temperature should be checked regularly. May evolve irritant or toxic fumes.             | 3112   |
| –      | –                                  | –             | F-F, S-R               | Category D SW1 SW3      | SG35<br>SG36<br>SG72        | May decompose violently at temperatures higher than the emergency temperature or in a fire. Burns vigorously. Immiscible with water. Contact with the eyes and skin should be avoided. Control and emergency temperatures for each formulation are given in table 2.5.3.2.4. The temperature should be checked regularly. May evolve irritant or toxic fumes. | 3113   |
| –      | –                                  | –             | F-F, S-R               | Category D SW1 SW3      | SG35<br>SG36<br>SG72        | May decompose violently at temperatures higher than the emergency temperature or in a fire. Burns vigorously. Insoluble in water. Contact with the eyes and skin should be avoided. Control and emergency temperatures for each formulation are given in table 2.5.3.2.4. The temperature should be checked regularly. May evolve irritant or toxic fumes.    | 3114   |
| –      | –                                  | –             | F-F, S-R               | Category D SW1 SW3      | SG35<br>SG36<br>SG72        | Decomposes at temperatures higher than the emergency temperature or in a fire. Burns vigorously. Immiscible with water. Contact with the eyes and skin should be avoided. Control and emergency temperatures for each formulation are given in table 2.5.3.2.4. The temperature should be checked regularly. May evolve irritant or toxic fumes.              | 3115   |



Part 3 – Dangerous Goods List, special provisions and exceptions

Chapter 3.2 – Dangerous Goods List

| UN No. | Proper shipping name (PSN)                              | Class or division | Subsidiary hazard(s) | Packing group  | Special provisions | Limited and excepted quantity provisions |                     | Packing      |              | IBC           |               |
|--------|---|-------------------|----------------------|----------------|--------------------|--|---------------------|--------------|--------------|---------------|---------------|
|        |   |                   |                      |                |                    | Limited quantities                       | Excepted quantities | Instructions | Provisions   | Instructions  | Provisions    |
| (1)    | (2)<br>3.1.2  | (3)<br>2.0        | (4)<br>2.0           | (5)<br>2.0.1.3 | (6)<br>3.3         | (7a)<br>3.4                              | (7b)<br>3.5         | (8)<br>4.1.4 | (9)<br>4.1.4 | (10)<br>4.1.4 | (11)<br>4.1.4 |
| 3116   | ORGANIC PEROXIDE TYPE D, SOLID, TEMPERATURE CONTROLLED  | 5.2               | –                    | –              | 122<br>274<br>923  | 0  | E0                  | P520         | –            | –             | –             |
| 3117   | ORGANIC PEROXIDE TYPE E, LIQUID, TEMPERATURE CONTROLLED | 5.2               | –                    | –              | 122<br>274<br>923  | 0  | E0                  | P520         | –            | –             | –             |
| 3118   | ORGANIC PEROXIDE TYPE E, SOLID, TEMPERATURE CONTROLLED  | 5.2               | –                    | –              | 122<br>274<br>923  | 0  | E0                  | P520         | –            | –             | –             |
| 3119   | ORGANIC PEROXIDE TYPE F, LIQUID, TEMPERATURE CONTROLLED | 5.2               | –                    | –              | 122<br>274<br>923  | 0  | E0                  | P520         | –            | IBC520        | –             |
| 3120   | ORGANIC PEROXIDE TYPE F, SOLID, TEMPERATURE CONTROLLED  | 5.2               | –                    | –              | 122<br>274<br>923  | 0  | E0                  | P520         | –            | IBC520        | –             |
| 3121   | OXIDIZING SOLID, WATER-REACTIVE, N.O.S.                 | 5.1               | 4.3                  | I              | 274<br>976         | 0  | E0                  | P099         | –            | –             | –             |
| 3121   | OXIDIZING SOLID, WATER-REACTIVE, N.O.S.                 | 5.1               | 4.3                  | II             | 274<br>976         | 0  | E0                  | P099         | –            | –             | –             |
| 3122   | TOXIC LIQUID, OXIDIZING, N.O.S.                         | 6.1               | 5.1                  | I              | 274<br>315         | 0  | E0                  | P001         | –            | –             | –             |
| 3122   | TOXIC LIQUID, OXIDIZING, N.O.S.                         | 6.1               | 5.1                  | II             | 274                | 100 mL                                   | E4                  | P001         | –            | IBC02         | –             |
| 3123   | TOXIC LIQUID, WATER-REACTIVE, N.O.S.                    | 6.1               | 4.3                  | I              | 274<br>315         | 0  | E0                  | P099         | –            | –             | –             |
| 3123   | TOXIC LIQUID, WATER-REACTIVE, N.O.S.                    | 6.1               | 4.3                  | II             | 274                | 100 mL                                   | E4                  | P001         | –            | IBC02         | –             |
| 3124   | TOXIC SOLID, SELF-HEATING, N.O.S.                       | 6.1               | 4.2                  | I              | 274                | 0  | E5                  | P002         | –            | –             | –             |
| 3124   | TOXIC SOLID, SELF-HEATING, N.O.S.                       | 6.1               | 4.2                  | II             | 274                | 0  | E4                  | P002         | –            | IBC06         | B21           |
| 3125   | TOXIC SOLID, WATER-REACTIVE, N.O.S.                     | 6.1               | 4.3                  | I              | 274                | 0  | E5                  | P099         | –            | –             | –             |
| 3125   | TOXIC SOLID, WATER-REACTIVE, N.O.S.                     | 6.1               | 4.3                  | II             | 274                | 500 g                                    | E4                  | P002         | PP100        | IBC06         | B21           |
| 3126   | SELF-HEATING SOLID, CORROSIVE, ORGANIC, N.O.S.          | 4.2               | 8                    | II             | 274                | 0  | E2                  | P410         | –            | IBC05         | B21           |

| UN No. | Portable tanks and bulk containers |               | EmS                    | Stowage and handling     | Segregation          | Properties and observations   | UN No. |
|--------|------------------------------------|---------------|------------------------|--------------------------|----------------------|---|--------|
|        | Tank instructions                  | Provisions    |                        |                          |                      |   |        |
| (12)   | (13)<br>4.2.5<br>4.3               | (14)<br>4.2.5 | (15)<br>5.4.3.4<br>7.8 | (16a)<br>7.1<br>7.3–7.7  | (16b)<br>7.2–7.7     | (17)  | (18)   |
| –      | –                                  | –             | F-F, S-R               | Category D<br>SW1<br>SW3 | SG35<br>SG36<br>SG72 | Decomposes at temperatures higher than the emergency temperature or in a fire. Burns vigorously. Insoluble in water except for diperoxyazelaic acid. Contact with the eyes and skin should be avoided. Control and emergency temperatures for each formulation are given in table 2.5.3.2.4. The temperature should be checked regularly. May evolve irritant or toxic fumes.   | 3116   |
| –      | –                                  | –             | F-F, S-R               | Category D<br>SW1<br>SW3 | SG35<br>SG36<br>SG72 | Decomposes at temperatures higher than the emergency temperature or in a fire. Burns vigorously. Immiscible with water. Contact with the eyes and skin should be avoided. Control and emergency temperatures for each formulation are given in table 2.5.3.2.4. The temperature should be checked regularly. May evolve irritant or toxic fumes.  | 3117   |
| –      | –                                  | –             | F-F, S-R               | Category D<br>SW1<br>SW3 | SG35<br>SG36<br>SG72 | Decomposes at temperatures higher than the emergency temperature or in a fire. Burns vigorously. Insoluble in water except for di-(2-ethylhexyl) peroxydicarbonate. Contact with the eyes and skin should be avoided. Control and emergency temperatures for each formulation are given in table 2.5.3.2.4. The temperature should be checked regularly. May evolve irritant or toxic fumes.  | 3118   |
| –      | T23                                | –             | F-F, S-R               | Category D<br>SW1<br>SW3 | SG35<br>SG36<br>SG72 | Decomposes at temperatures higher than the emergency temperature or in a fire. Burns vigorously. Immiscible with water except for di-(4-tert-butylcyclohexyl) peroxydicarbonate, dicetyl peroxydicarbonate and dimyristyl peroxydicarbonate. Contact with the eyes and skin should be avoided. Control and emergency temperatures for each formulation are given in table 2.5.3.2.4. The temperature should be checked regularly. May evolve irritant or toxic fumes. | 3119   |
| –      | T23                                | TP33          | F-F, S-R               | Category D<br>SW1<br>SW3 | SG35<br>SG36<br>SG72 | Decomposes at temperatures higher than the emergency temperature or in a fire. Burns vigorously. Insoluble in water. Contact with the eyes and skin should be avoided. Control and emergency temperatures for each formulation are given in the table 2.5.3.2.4. The temperature should be checked regularly. May evolve irritant or toxic fumes.   | 3120   |
| –      | –                                  | –             | F-G, S-L               | H1                       | SG26                 | –   | 3121   |
| –      | –                                  | –             | F-G, S-L               | H1                       | SG26                 | –   | 3121   |
| –      | –                                  | –             | F-A, S-Q               | Category C               | –                    | Toxic if swallowed, by skin contact or by inhalation.   | 3122   |
| –      | –                                  | –             | F-A, S-Q               | Category C               | –                    | See entry above.  | 3122   |
| –      | –                                  | –             | F-G, S-N               | Category D<br>SW2<br>H1  | SG26                 | Toxic if swallowed, by skin contact or by inhalation.   | 3123   |
| –      | –                                  | –             | F-G, S-N               | Category D<br>SW2<br>H1  | SG26                 | See entry above.  | 3123   |
| –      | T6                                 | TP33          | F-A, S-J               | Category D<br>SW2        | –                    | Highly toxic if swallowed, by skin contact or by inhalation.  | 3124   |
| –      | T3                                 | TP33          | F-A, S-J               | Category D<br>SW2        | –                    | See entry above.  | 3124   |
| –      | T6                                 | TP33          | F-G, S-N               | Category D<br>SW2<br>H1  | SG26                 | Toxic if swallowed, by skin contact or by inhalation.   | 3125   |
| –      | T3                                 | TP33          | F-G, S-N               | Category D<br>SW2<br>H1  | SG26                 | See entry above.  | 3125   |
| –      | T3                                 | TP33          | F-A, S-J               | Category C               | –                    | –   | 3126   |

Part 3 – Dangerous Goods List, special provisions and exceptions

Chapter 3.2 – Dangerous Goods List

| UN No. | Proper shipping name (PSN)                     | Class or division | Subsidiary hazard(s) | Packing group  | Special provisions | Limited and excepted quantity provisions |                     | Packing      |              | IBC           |               |
|--------|--|-------------------|----------------------|----------------|--------------------|--|---------------------|--------------|--------------|---------------|---------------|
|        |  |                   |                      |                |                    | Limited quantities                       | Excepted quantities | Instructions | Provisions   | Instructions  | Provisions    |
| (1)    | (2)<br>3.1.2                                   | (3)<br>2.0        | (4)<br>2.0           | (5)<br>2.0.1.3 | (6)<br>3.3         | (7a)<br>3.4                              | (7b)<br>3.5         | (8)<br>4.1.4 | (9)<br>4.1.4 | (10)<br>4.1.4 | (11)<br>4.1.4 |
| 3126   | SELF-HEATING SOLID, CORROSIVE, ORGANIC, N.O.S. | 4.2               | 8                    | III            | 223<br>274         | 0  | E1                  | P002         | -            | IBC08         | B3            |
| 3127   | SELF-HEATING SOLID, OXIDIZING, N.O.S.          | 4.2               | 5.1                  | II             | 274<br>976         | 0  | E0                  | P099         | -            | -             | -             |
| 3127   | SELF-HEATING SOLID, OXIDIZING, N.O.S.          | 4.2               | 5.1                  | III            | 223<br>274<br>976  | 0  | E0                  | P099         | -            | -             | -             |
| 3128   | SELF-HEATING SOLID, TOXIC, ORGANIC, N.O.S.     | 4.2               | 6.1                  | II             | 274                | 0  | E2                  | P410         | -            | IBC05         | B21           |
| 3128   | SELF-HEATING SOLID, TOXIC, ORGANIC, N.O.S.     | 4.2               | 6.1                  | III            | 223<br>274         | 0  | E1                  | P002         | -            | IBC08         | B3            |
| 3129   | WATER-REACTIVE LIQUID, CORROSIVE, N.O.S.       | 4.3               | 8                    | I              | 274                | 0  | E0                  | P402         | -            | -             | -             |
| △ 3129 | WATER-REACTIVE LIQUID, CORROSIVE, N.O.S.       | 4.3               | 8                    | II             | 274                | 0  | E0                  | P402         | -            | IBC01         | -             |
| △ 3129 | WATER-REACTIVE LIQUID, CORROSIVE, N.O.S.       | 4.3               | 8                    | III            | 223<br>274         | 0  | E1                  | P001         | -            | IBC02         | -             |
| 3130   | WATER-REACTIVE LIQUID, TOXIC, N.O.S.           | 4.3               | 6.1                  | I              | 274                | 0  | E0                  | P402         | -            | -             | -             |
| △ 3130 | WATER-REACTIVE LIQUID, TOXIC, N.O.S.           | 4.3               | 6.1                  | II             | 274                | 0  | E0                  | P402         | -            | IBC01         | -             |
| △ 3130 | WATER-REACTIVE LIQUID, TOXIC, N.O.S.           | 4.3               | 6.1                  | III            | 223<br>274         | 0  | E1                  | P001         | -            | IBC02         | -             |
| 3131   | WATER-REACTIVE SOLID, CORROSIVE, N.O.S.        | 4.3               | 8                    | I              | 274                | 0  | E0                  | P403         | PP31         | -             | -             |
| 3131   | WATER-REACTIVE SOLID, CORROSIVE, N.O.S.        | 4.3               | 8                    | II             | 274                | 0  | E2                  | P410         | PP31<br>PP40 | IBC06         | B21           |
| 3131   | WATER-REACTIVE SOLID, CORROSIVE, N.O.S.        | 4.3               | 8                    | III            | 223<br>274         | 0  | E1                  | P410         | PP31         | IBC08         | B4            |
| 3132   | WATER-REACTIVE SOLID, FLAMMABLE, N.O.S.        | 4.3               | 4.1                  | I              | 274                | 0  | E0                  | P403         | PP31         | IBC99         | -             |
| 3132   | WATER-REACTIVE SOLID, FLAMMABLE, N.O.S.        | 4.3               | 4.1                  | II             | 274                | 0  | E2                  | P410         | PP31<br>PP40 | IBC04         | -             |
| 3132   | WATER-REACTIVE SOLID, FLAMMABLE, N.O.S.        | 4.3               | 4.1                  | III            | 223<br>274         | 0  | E1                  | P410         | PP31         | IBC06         | -             |
| 3133   | WATER-REACTIVE SOLID, OXIDIZING, N.O.S.        | 4.3               | 5.1                  | II             | 274<br>976         | 0  | E0                  | P099         | -            | -             | -             |
| 3133   | WATER-REACTIVE SOLID, OXIDIZING, N.O.S.        | 4.3               | 5.1                  | III            | 223<br>274<br>976  | 0  | E0                  | P099         | -            | -             | -             |
| 3134   | WATER-REACTIVE SOLID, TOXIC, N.O.S.            | 4.3               | 6.1                  | I              | 274                | 0  | E0                  | P403         | PP31         | -             | -             |
| 3134   | WATER-REACTIVE SOLID, TOXIC, N.O.S.            | 4.3               | 6.1                  | II             | 274                | 500 g                                    | E2                  | P410         | PP31<br>PP40 | IBC05         | B21           |

| UN No. | Portable tanks and bulk containers |                    | EmS                    | Stowage and handling     | Segregation      | Properties and observations | UN No. |
|--------|------------------------------------|--------------------|------------------------|--------------------------|------------------|-----------------------------|--------|
|        | Tank instructions                  | Provisions         |                        |                          |                  |                             |        |
| (12)   | (13)<br>4.2.5<br>4.3               | (14)<br>4.2.5      | (15)<br>5.4.3.4<br>7.8 | (16a)<br>7.1<br>7.3-7.7  | (16b)<br>7.2-7.7 | (17)                        | (18)   |
| -      | T1                                 | TP33               | F-A, S-J               | Category C               | -                | -                           | 3126   |
| -      | T3                                 | TP33               | F-A, S-J               | -                        | -                | -                           | 3127   |
| -      | T1                                 | TP33               | F-A, S-J               | -                        | -                | -                           | 3127   |
| -      | T3                                 | TP33               | F-A, S-J               | Category C               | -                | -                           | 3128   |
| -      | T1                                 | TP33               | F-A, S-J               | Category C               | -                | -                           | 3128   |
| -      | T14                                | TP2<br>TP7<br>TP13 | F-G, S-N               | Category D<br>H1         | SG26             | -                           | 3129   |
| -      | T11                                | TP2<br>TP7         | F-G, S-N               | Category D<br>SW31<br>H1 | SG26             | -                           | 3129 △ |
| -      | T7                                 | TP2<br>TP7         | F-G, S-N               | Category D<br>SW31<br>H1 | SG26             | -                           | 3129 △ |
| -      | -                                  | -                  | F-G, S-N               | Category D<br>H1         | SG26             | -                           | 3130   |
| -      | -                                  | -                  | F-G, S-N               | Category D<br>SW31<br>H1 | SG26             | -                           | 3130 △ |
| -      | -                                  | -                  | F-G, S-N               | Category D<br>SW31<br>H1 | SG26             | -                           | 3130 △ |
| -      | T9                                 | TP7<br>TP33        | F-G, S-L               | Category D<br>H1         | SG26             | -                           | 3131   |
| -      | T3                                 | TP33               | F-G, S-L               | Category E<br>SW5<br>H1  | SG26             | -                           | 3131   |
| -      | T1                                 | TP33               | F-G, S-L               | Category E<br>SW5<br>H1  | SG26             | -                           | 3131   |
| -      | -                                  | -                  | F-G, S-N               | Category D<br>H1         | SG26             | -                           | 3132   |
| -      | T3                                 | TP33               | F-G, S-N               | Category E<br>SW5<br>H1  | SG26             | -                           | 3132   |
| -      | T1                                 | TP33               | F-G, S-N               | Category E<br>SW5<br>H1  | SG26             | -                           | 3132   |
| -      | -                                  | -                  | F-G, S-L               | H1                       | SG26             | -                           | 3133   |
| -      | -                                  | -                  | F-G, S-L               | H1                       | SG26             | -                           | 3133   |
| -      | -                                  | -                  | F-G, S-N               | Category D<br>H1         | SG26             | -                           | 3134   |
| -      | T3                                 | TP33               | F-G, S-N               | Category E<br>SW5<br>H1  | SG26             | -                           | 3134   |

Part 3 – Dangerous Goods List, special provisions and exceptions

Chapter 3.2 – Dangerous Goods List

| UN No. | Proper shipping name (PSN)   | Class or division | Subsidiary hazard(s) | Packing group  | Special provisions | Limited and excepted quantity provisions |                     | Packing      |              | IBC           |               |
|--------|--|-------------------|----------------------|----------------|--------------------|--|---------------------|--------------|--------------|---------------|---------------|
|        |  |                   |                      |                |                    | Limited quantities                       | Excepted quantities | Instructions | Provisions   | Instructions  | Provisions    |
| (1)    | (2)<br>3.1.2   | (3)<br>2.0        | (4)<br>2.0           | (5)<br>2.0.1.3 | (6)<br>3.3         | (7a)<br>3.4                              | (7b)<br>3.5         | (8)<br>4.1.4 | (9)<br>4.1.4 | (10)<br>4.1.4 | (11)<br>4.1.4 |
| 3134   | WATER-REACTIVE SOLID, TOXIC, N.O.S.  | 4.3               | 6.1                  | III            | 223<br>274         | 1 kg                                     | E1                  | P410         | PP31         | IBC08         | B4            |
| 3135   | WATER-REACTIVE SOLID, SELF-HEATING, N.O.S.   | 4.3               | 4.2                  | I              | 274                | 0  | E0                  | P403         | PP31         | -             | -             |
| 3135   | WATER-REACTIVE SOLID, SELF-HEATING, N.O.S.   | 4.3               | 4.2                  | II             | 274                | 0  | E2                  | P410         | PP31         | IBC05         | B21           |
| 3135   | WATER-REACTIVE SOLID, SELF-HEATING, N.O.S.   | 4.3               | 4.2                  | III            | 223<br>274         | 0  | E1                  | P410         | PP31         | IBC08         | B4            |
| 3136   | TRIFLUOROMETHANE, REFRIGERATED LIQUID  | 2.2               | -                    | -              | -                  | 120 mL                                   | E1                  | P203         | -            | -             | -             |
| 3137   | OXIDIZING SOLID, FLAMMABLE, N.O.S.   | 5.1               | 4.1                  | I              | 274<br>976         | 0  | E0                  | P099         | -            | -             | -             |
| 3138   | ETHYLENE, ACETYLENE AND PROPYLENE MIXTURE, REFRIGERATED LIQUID containing at least 71.5% ethylene, with not more than 22.5% acetylene and not more than 6% propylene | 2.1               | -                    | -              | -                  | 0  | E0                  | P203         | -            | -             | -             |
| 3139   | OXIDIZING LIQUID, N.O.S.   | 5.1               | -                    | I              | 274                | 0  | E0                  | P502         | -            | -             | -             |
| 3139   | OXIDIZING LIQUID, N.O.S.   | 5.1               | -                    | II             | 274                | 1 L                                      | E2                  | P504         | -            | IBC02         | -             |
| 3139   | OXIDIZING LIQUID, N.O.S.   | 5.1               | -                    | III            | 223<br>274         | 5 L                                      | E1                  | P504         | -            | IBC02         | -             |
| 3140   | ALKALOIDS, LIQUID, N.O.S. or ALKALOIDS SALTS, LIQUID, N.O.S.   | 6.1               | -                    | I              | 43<br>274          | 0  | E5                  | P001         | -            | -             | -             |
| 3140   | ALKALOIDS, LIQUID, N.O.S. or ALKALOIDS SALTS, LIQUID, N.O.S.   | 6.1               | -                    | II             | 43<br>274          | 100 mL                                   | E4                  | P001         | -            | IBC02         | -             |
| 3140   | ALKALOIDS, LIQUID, N.O.S. or ALKALOIDS SALTS, LIQUID, N.O.S.   | 6.1               | -                    | III            | 43<br>223<br>274   | 5 L                                      | E1                  | P001<br>LP01 | -            | IBC03         | -             |
| 3141   | ANTIMONY COMPOUND, INORGANIC, LIQUID, N.O.S.   | 6.1               | -                    | III            | 45<br>274          | 5 L                                      | E1                  | P001<br>LP01 | -            | IBC03         | -             |
| 3142   | DISINFECTANT, LIQUID, TOXIC, N.O.S.  | 6.1               | -                    | I              | 274                | 0  | E5                  | P001         | -            | -             | -             |
| 3142   | DISINFECTANT, LIQUID, TOXIC, N.O.S.  | 6.1               | -                    | II             | 274                | 100 mL                                   | E4                  | P001         | -            | IBC02         | -             |
| 3142   | DISINFECTANT, LIQUID, TOXIC, N.O.S.  | 6.1               | -                    | III            | 223<br>274         | 5 L                                      | E1                  | P001<br>LP01 | -            | IBC03         | -             |
| 3143   | DYE, SOLID, TOXIC, N.O.S. or DYE INTERMEDIATE, SOLID, TOXIC, N.O.S.  | 6.1               | -                    | I              | 274                | 0  | E5                  | P002         | -            | IBC07         | B1            |
| 3143   | DYE, SOLID, TOXIC, N.O.S. or DYE INTERMEDIATE, SOLID, TOXIC, N.O.S.  | 6.1               | -                    | II             | 274                | 500 g                                    | E4                  | P002         | -            | IBC08         | B4<br>B21     |

| UN No. | Portable tanks and bulk containers |               | EmS                    | Stowage and handling    | Segregation          | Properties and observations  | UN No. |
|--------|------------------------------------|---------------|------------------------|-------------------------|----------------------|--|--------|
|        | Tank instructions                  | Provisions    |                        |                         |                      |  |        |
| (12)   | (13)<br>4.2.5<br>4.3               | (14)<br>4.2.5 | (15)<br>5.4.3.4<br>7.8 | (16a)<br>7.1<br>7.3-7.7 | (16b)<br>7.2-7.7     | (17)   | (18)   |
| -      | T1                                 | TP33          | F-G, S-N               | Category E SW5 H1       | SG26                 | -  | 3134   |
| -      | -                                  | -             | F-G, S-N               | Category D H1           | SG26                 | -  | 3135   |
| -      | T3                                 | TP33          | F-G, S-N               | Category E SW5 H1       | SG26                 | -  | 3135   |
| -      | T1                                 | TP33          | F-G, S-N               | Category E SW5 H1       | SG26                 | -  | 3135   |
| -      | T75                                | TP5           | F-C, S-V               | Category D              | -                    | Liquefied, non-flammable gas. Much heavier than air (2.4).   | 3136   |
| -      | -                                  | -             | F-G, S-Q               | H1                      | SG25<br>SG26         | -  | 3137   |
| -      | T75                                | TP5           | F-D, S-U               | Category D SW2          | SG46                 | Liquefied, flammable, colourless mixture of gases with a garlic odour. Explosive limits: 2.7% to 36%. Lighter than air (0.96). | 3138   |
| -      | -                                  | -             | F-A, S-Q               | Category D              | SG38<br>SG49<br>SG60 | -  | 3139   |
| -      | -                                  | -             | F-A, S-Q               | Category B              | SG38<br>SG49<br>SG60 | -  | 3139   |
| -      | -                                  | -             | F-A, S-Q               | Category B              | SG38<br>SG49<br>SG60 | -  | 3139   |
| -      | -                                  | -             | F-A, S-A               | Category A              | -                    | A wide range of toxic liquids, generally of vegetable origin. Toxic if swallowed, by skin contact or by inhalation.            | 3140   |
| -      | -                                  | -             | F-A, S-A               | Category A              | -                    | See entry above.   | 3140   |
| -      | -                                  | -             | F-A, S-A               | Category A              | -                    | See entry above.   | 3140   |
| -      | -                                  | -             | F-A, S-A               | Category A              | -                    | A wide range of toxic liquids. Toxic if swallowed, by skin contact or by inhalation.   | 3141   |
| -      | -                                  | -             | F-A, S-A               | Category A SW2          | -                    | A wide range of toxic liquids. Toxic if swallowed, by skin contact or by inhalation.   | 3142   |
| -      | -                                  | -             | F-A, S-A               | Category A SW2          | -                    | See entry above.   | 3142   |
| -      | -                                  | -             | F-A, S-A               | Category A SW2          | -                    | See entry above.   | 3142   |
| -      | T6                                 | TP33          | F-A, S-A               | Category A              | -                    | A wide range of toxic solids. Toxic if swallowed, by skin contact or by inhalation.  | 3143   |
| -      | T3                                 | TP33          | F-A, S-A               | Category A              | -                    | See entry above.   | 3143   |

Part 3 – Dangerous Goods List, special provisions and exceptions

Chapter 3.2 – Dangerous Goods List

| UN No. | Proper shipping name (PSN)   | Class or division | Subsidiary hazard(s) | Packing group  | Special provisions | Limited and excepted quantity provisions |                     | Packing      |              | IBC           |               |
|--------|--|-------------------|----------------------|----------------|--------------------|--|---------------------|--------------|--------------|---------------|---------------|
|        |  |                   |                      |                |                    | Limited quantities                       | Excepted quantities | Instructions | Provisions   | Instructions  | Provisions    |
| (1)    | (2)<br>3.1.2   | (3)<br>2.0        | (4)<br>2.0           | (5)<br>2.0.1.3 | (6)<br>3.3         | (7a)<br>3.4                              | (7b)<br>3.5         | (8)<br>4.1.4 | (9)<br>4.1.4 | (10)<br>4.1.4 | (11)<br>4.1.4 |
| 3143   | DYE, SOLID, TOXIC, N.O.S. or DYE INTERMEDIATE, SOLID, TOXIC, N.O.S.  | 6.1               | –                    | III            | 223<br>274         | 5 kg                                     | E1                  | P002<br>LP02 | –            | IBC08         | B3            |
| 3144   | NICOTINE COMPOUND, LIQUID, N.O.S. or NICOTINE PREPARATION, LIQUID, N.O.S.  | 6.1               | –                    | I              | 43<br>274          | 0  | E5                  | P001         | –            | –             | –             |
| 3144   | NICOTINE COMPOUND, LIQUID, N.O.S. or NICOTINE PREPARATION, LIQUID, N.O.S.  | 6.1               | –                    | II             | 43<br>274          | 100 mL                                   | E4                  | P001         | –            | IBC02         | –             |
| 3144   | NICOTINE COMPOUND, LIQUID, N.O.S. or NICOTINE PREPARATION, LIQUID, N.O.S.  | 6.1               | –                    | III            | 43<br>223<br>274   | 5 L                                      | E1                  | P001<br>LP01 | –            | IBC03         | –             |
| 3145   | ALKYLPHENOLS, LIQUID, N.O.S. (including C <sub>2</sub> –C <sub>12</sub> homologues)                                    | 8                 | –                    | I              | –                  | 0  | E0                  | P001         | –            | –             | –             |
| 3145   | ALKYLPHENOLS, LIQUID, N.O.S. (including C <sub>2</sub> –C <sub>12</sub> homologues)                                    | 8                 | –                    | II             | –                  | 1 L                                      | E2                  | P001         | –            | IBC02         | –             |
| 3145   | ALKYLPHENOLS, LIQUID, N.O.S. (including C <sub>2</sub> –C <sub>12</sub> homologues)                                    | 8                 | –                    | III            | 223                | 5 L                                      | E1                  | P001<br>LP01 | –            | IBC03         | –             |
| 3146   | ORGANOTIN COMPOUND, SOLID, N.O.S.  | 6.1               | –<br>P               | I              | 43<br>274          | 0  | E5                  | P002         | –            | IBC07         | B1            |
| 3146   | ORGANOTIN COMPOUND, SOLID, N.O.S.  | 6.1               | –<br>P               | II             | 43<br>274          | 500 g                                    | E4                  | P002         | –            | IBC08         | B4<br>B21     |
| 3146   | ORGANOTIN COMPOUND, SOLID, N.O.S.  | 6.1               | –<br>P               | III            | 43<br>223<br>274   | 5 kg                                     | E1                  | P002<br>LP02 | –            | IBC08         | B3            |
| 3147   | DYE, SOLID, CORROSIVE, N.O.S. or DYE INTERMEDIATE, SOLID, CORROSIVE, N.O.S.  | 8                 | –                    | I              | 274                | 0  | E0                  | P002         | –            | IBC07         | B1            |
| 3147   | DYE, SOLID, CORROSIVE, N.O.S. or DYE INTERMEDIATE, SOLID, CORROSIVE, N.O.S.  | 8                 | –                    | II             | 274                | 1 kg                                     | E2                  | P002         | –            | IBC08         | B4<br>B21     |
| 3147   | DYE, SOLID, CORROSIVE, N.O.S. or DYE INTERMEDIATE, SOLID, CORROSIVE, N.O.S.  | 8                 | –                    | III            | 223<br>274         | 5 kg                                     | E1                  | P002<br>LP02 | –            | IBC08         | B3            |
| △ 3148 | WATER-REACTIVE LIQUID, N.O.S.  | 4.3               | –                    | I              | 274                | 0  | E0                  | P402         | PP31         | –             | –             |
| △ 3148 | WATER-REACTIVE LIQUID, N.O.S.  | 4.3               | –                    | II             | 274                | 500 mL                                   | E2                  | P402         | PP31         | IBC01         | –             |
| △ 3148 | WATER-REACTIVE LIQUID, N.O.S.  | 4.3               | –                    | III            | 223<br>274         | 1 L                                      | E1                  | P001         | PP31         | IBC02         | –             |
| 3149   | HYDROGEN PEROXIDE AND PEROXYACETIC ACID MIXTURE with acid(s), water and not more than 5% peroxyacetic acid, STABILIZED | 5.1               | 8                    | II             | 196                | 1 L                                      | E2                  | P504         | PP10         | IBC02         | B5            |
| 3150   | DEVICES, SMALL, HYDROCARBON GAS POWERED or HYDROCARBON GAS REFILLS FOR SMALL DEVICES with release device               | 2.1               | –                    | –              | –                  | 0  | E0                  | P003         | –            | –             | –             |

| UN No. | Portable tanks and bulk containers |                    | EmS                    | Stowage and handling            | Segregation                   | Properties and observations   | UN No. |
|--------|------------------------------------|--------------------|------------------------|---------------------------------|-------------------------------|---|--------|
|        | Tank instructions                  | Provisions         |                        |                                 |                               |   |        |
| (12)   | (13)<br>4.2.5<br>4.3               | (14)<br>4.2.5      | (15)<br>5.4.3.4<br>7.8 | (16a)<br>7.1<br>7.3–7.7         | (16b)<br>7.2–7.7              | (17)  | (18)   |
| –      | T1                                 | TP33               | F-A, S-A               | Category A                      | –                             | A wide range of toxic solids. Toxic if swallowed, by skin contact or by inhalation.   | 3143   |
| –      | –                                  | –                  | F-A, S-A               | Category B<br>SW2               | –                             | A wide variety of toxic liquids. Toxic if swallowed, by skin contact or by inhalation.  | 3144   |
| –      | –                                  | –                  | F-A, S-A               | Category B<br>SW2               | –                             | See entry above.  | 3144   |
| –      | –                                  | –                  | F-A, S-A               | Category B<br>SW2               | –                             | See entry above.  | 3144   |
| –      | T14                                | TP2                | F-A, S-B               | Category B                      | –                             | A wide range of colourless to pale straw-coloured liquids with penetrating odours (sometimes camphor-like). Liquids slightly miscible with water. Cause burns to skin, eyes and mucous membranes.   | 3145   |
| –      | T11                                | TP2<br>TP27        | F-A, S-B               | Category B                      | –                             | See entry above.  | 3145   |
| –      | T7                                 | TP1<br>TP28        | F-A, S-B               | Category A                      | –                             | See entry above.  | 3145   |
| –      | T6                                 | TP33               | F-A, S-A               | Category B<br>SW2               | –                             | A wide variety of toxic solids. Toxic if swallowed, by skin contact or by inhalation.   | 3146   |
| –      | T3                                 | TP33               | F-A, S-A               | Category A<br>SW2               | –                             | See entry above.  | 3146   |
| –      | T1                                 | TP33               | F-A, S-A               | Category A<br>SW2               | –                             | See entry above.  | 3146   |
| –      | T6                                 | TP33               | F-A, S-B               | Category A                      | –                             | A wide range of corrosive solids or pastes. Cause burns to skin, eyes and mucous membranes.   | 3147   |
| –      | T3                                 | TP33               | F-A, S-B               | Category A                      | –                             | See entry above.  | 3147   |
| –      | T1                                 | TP33               | F-A, S-B               | Category A                      | –                             | See entry above.  | 3147   |
| –      | T13                                | TP2<br>TP7         | F-G, S-N               | Category D<br>SW2<br>SW31<br>H1 | SG26                          | –   | 3148 △ |
| –      | T7                                 | TP2<br>TP7         | F-G, S-N               | Category D<br>SW2<br>SW31<br>H1 | SG26                          | –   | 3148 △ |
| –      | T7                                 | TP2<br>TP7         | F-G, S-N               | Category D<br>SW2<br>SW31<br>H1 | SG26                          | –   | 3148 △ |
| –      | T7                                 | TP2<br>TP6<br>TP24 | F-H, S-Q               | Category D<br>SW1               | SGG16<br>SG16<br>SG59<br>SG72 | Colourless liquid. Carried as an aqueous solution. Slowly decomposes, evolving oxygen; the rate of decomposition increases on contact with most metals. In contact with combustible material, may cause fire. Causes burns to skin, eyes and mucous membranes. Even though stabilized, these solutions may evolve oxygen. | 3149   |
| –      | –                                  | –                  | F-D, S-U               | Category B<br>SW2               | –                             | Various small devices used for cosmetic and other purposes, and their refills.  | 3150   |

Part 3 – Dangerous Goods List, special provisions and exceptions

Chapter 3.2 – Dangerous Goods List

| UN No. | Proper shipping name (PSN)   | Class or division | Subsidiary hazard(s) | Packing group  | Special provisions       | Limited and excepted quantity provisions |                     | Packing      |              | IBC           |               |
|--------|--|-------------------|----------------------|----------------|--------------------------|--|---------------------|--------------|--------------|---------------|---------------|
|        |  |                   |                      |                |                          | Limited quantities                       | Excepted quantities | Instructions | Provisions   | Instructions  | Provisions    |
| (1)    | (2)<br>3.1.2   | (3)<br>2.0        | (4)<br>2.0           | (5)<br>2.0.1.3 | (6)<br>3.3               | (7a)<br>3.4                              | (7b)<br>3.5         | (8)<br>4.1.4 | (9)<br>4.1.4 | (10)<br>4.1.4 | (11)<br>4.1.4 |
| 3151   | POLYHALOGENATED BIPHENYLS, LIQUID or HALOGENATED MONOMETHYL-DIPHENYLMETHANES, LIQUID or POLYHALOGENATED TERPHENYLS, LIQUID                                       | 9                 | -<br>P               | II             | 203<br>305               | 1 L                                      | E2                  | P906         | -            | IBC02         | -             |
| 3152   | POLYHALOGENATED BIPHENYLS, SOLID or HALOGENATED MONOMETHYL-DIPHENYLMETHANES, SOLID or POLYHALOGENATED TERPHENYLS, SOLID  | 9                 | -<br>P               | II             | 203<br>305<br>958        | 1 kg                                     | E2                  | P906         | -            | IBC08         | B4<br>B21     |
| 3153   | PERFLUORO(METHYL VINYL ETHER)  | 2.1               | -                    | -              | -                        | 0  | E0                  | P200         | -            | -             | -             |
| 3154   | PERFLUORO(ETHYL VINYL ETHER)   | 2.1               | -                    | -              | -                        | 0  | E0                  | P200         | -            | -             | -             |
| 3155   | PENTACHLOROPHENOL  | 6.1               | -<br>P               | II             | 43                       | 500 g                                    | E4                  | P002         | -            | IBC08         | B4<br>B21     |
| 3156   | COMPRESSED GAS, OXIDIZING, N.O.S.  | 2.2               | 5.1                  | -              | 274                      | 0  | E0                  | P200         | -            | -             | -             |
| 3157   | LIQUEFIED GAS, OXIDIZING, N.O.S.   | 2.2               | 5.1                  | -              | 274                      | 0  | E0                  | P200         | -            | -             | -             |
| 3158   | GAS, REFRIGERATED LIQUID, N.O.S.   | 2.2               | -                    | -              | 274                      | 120 mL                                   | E1                  | P203         | -            | -             | -             |
| 3159   | 1,1,1,2-TETRAFLUOROETHANE (REFRIGERANT GAS R 134a)   | 2.2               | -                    | -              | -                        | 120 mL                                   | E1                  | P200         | -            | -             | -             |
| 3160   | LIQUEFIED GAS, TOXIC, FLAMMABLE, N.O.S.  | 2.3               | 2.1                  | -              | 274                      | 0  | E0                  | P200         | -            | -             | -             |
| 3161   | LIQUEFIED GAS, FLAMMABLE, N.O.S.   | 2.1               | -                    | -              | 274                      | 0  | E0                  | P200         | -            | -             | -             |
| 3162   | LIQUEFIED GAS, TOXIC, N.O.S.   | 2.3               | -                    | -              | 274                      | 0  | E0                  | P200         | -            | -             | -             |
| 3163   | LIQUEFIED GAS, N.O.S.  | 2.2               | -                    | -              | 274<br>392               | 120 mL                                   | E1                  | P200         | -            | -             | -             |
| 3164   | ARTICLES, PRESSURIZED, PNEUMATIC or HYDRAULIC (containing non-flammable gas)   | 2.2               | -                    | -              | 283<br>371               | 120 mL                                   | E0                  | P003         | PP32         | -             | -             |
| △ 3165 | AIRCRAFT HYDRAULIC POWER UNIT FUEL TANK (containing a mixture of anhydrous hydrazine and methylhydrazine) (M86 fuel)   | 3                 | 6.1/8                | -              | -                        | 0  | E0                  | P301         | -            | -             | -             |
| 3166   | VEHICLE, FLAMMABLE GAS POWERED or VEHICLE, FLAMMABLE LIQUID POWERED or VEHICLE, FUEL CELL, FLAMMABLE GAS POWERED or VEHICLE, FUEL CELL, FLAMMABLE LIQUID POWERED | 9                 | -                    | -              | 356<br>388<br>961<br>962 | -  | -                   | -            | -            | -             | -             |
| 3167   | GAS SAMPLE, NON-PRESSURIZED, FLAMMABLE, N.O.S., not refrigerated liquid  | 2.1               | -                    | -              | 209                      | 0  | E0                  | P201         | -            | -             | -             |
| 3168   | GAS SAMPLE, NON-PRESSURIZED, TOXIC, FLAMMABLE, N.O.S., not refrigerated liquid   | 2.3               | 2.1                  | -              | 209                      | 0  | E0                  | P201         | -            | -             | -             |

| UN No. | Portable tanks and bulk containers |               | EmS                    | Stowage and handling    | Segregation        | Properties and observations  | UN No. |
|--------|------------------------------------|---------------|------------------------|-------------------------|--------------------|--|--------|
|        | Tank instructions                  | Provisions    |                        |                         |                    |  |        |
| (12)   | (13)<br>4.2.5<br>4.3               | (14)<br>4.2.5 | (15)<br>5.4.3.4<br>7.8 | (16a)<br>7.1<br>7.3-7.7 | (16b)<br>7.2-7.7   | (17)   | (18)   |
| -      | -                                  | -             | F-A, S-A               | Category A              | SG50               | Viscous liquids with a perceptible odour. Harmful by ingestion or by skin contact. This entry also covers articles, such as transformers and condensers, containing free liquid polyhalogenated biphenyls or polyhalogenated terphenyls.   | 3151   |
| -      | T3                                 | TP33          | F-A, S-A               | Category A              | SG50               | Solid with a perceptible odour. Melting point of solids varies from 2°C to 164°C. Harmful by ingestion or by skin contact. This entry also covers articles, such as rags, cotton waste, clothing or sawdust, containing polyhalogenated biphenyls or polyhalogenated terphenyls where no free visible liquid is present. | 3152   |
| -      | T50                                | -             | F-D, S-U               | Category E SW2          | -                  | Explosive limits: 7% to 73%. Much heavier than air (4.8). Boiling point: -27°C.  | 3153   |
| -      | -                                  | -             | F-D, S-U               | Category E SW2          | -                  | Explosive limits: 7% to 73%. Much heavier than air (6.4). Boiling point: 12°C.   | 3154   |
| -      | T3                                 | TP33          | F-A, S-A               | Category A              | -                  | Toxic if swallowed, by skin contact or by dust inhalation.   | 3155   |
| -      | -                                  | -             | F-C, S-W               | Category D              | -                  | -  | 3156   |
| -      | -                                  | -             | F-C, S-W               | Category D              | -                  | -  | 3157   |
| -      | T75                                | TP5           | F-C, S-V               | Category D              | -                  | -  | 3158   |
| -      | T50                                | -             | F-C, S-V               | Category A              | -                  | Non-flammable gas with a mild ether-like odour. Much heavier than air (3.5).   | 3159   |
| -      | -                                  | -             | F-D, S-U               | Category D SW2          | -                  | -  | 3160   |
| -      | T50                                | -             | F-D, S-U               | Category D SW2          | -                  | -  | 3161   |
| -      | -                                  | -             | F-C, S-U               | Category D SW2          | -                  | -  | 3162   |
| -      | T50                                | -             | F-C, S-V               | Category A              | -                  | -  | 3163   |
| -      | -                                  | -             | F-C, S-V               | Category A              | -                  | Articles containing non-flammable, non-toxic gas necessary for their operation.  | 3164   |
| -      | -                                  | -             | F-E, S-C               | Category D SW2          | SG5<br>SG8<br>SG13 | The mixture is miscible with water and may react dangerously with oxidizing substances. The mixture is highly toxic if swallowed, by skin contact or by inhalation. Causes burns to skin, eyes and mucous membranes.   | △ 3165 |
| -      | -                                  | -             | *                      | Category A              | -                  | Types of articles transported under this entry include, but are not limited to motor vehicles, hybrid vehicles, fuel cell powered vehicles, motorcycles and boats.<br>*F-D, S-U for gases or F-E, S-E for liquids.   | 3166   |
| -      | -                                  | -             | F-D, S-U               | Category D              | -                  | -  | 3167   |
| -      | -                                  | -             | F-D, S-U               | Category D              | -                  | -  | 3168   |



Part 3 – Dangerous Goods List, special provisions and exceptions

Chapter 3.2 – Dangerous Goods List

| UN No. | Proper shipping name (PSN)  | Class or division | Subsidiary hazard(s) | Packing group  | Special provisions       | Limited and excepted quantity provisions |                     | Packing      |              | IBC           |               |
|--------|---|-------------------|----------------------|----------------|--------------------------|--|---------------------|--------------|--------------|---------------|---------------|
|        |   |                   |                      |                |                          | Limited quantities                       | Excepted quantities | Instructions | Provisions   | Instructions  | Provisions    |
| (1)    | (2)<br>3.1.2  | (3)<br>2.0        | (4)<br>2.0           | (5)<br>2.0.1.3 | (6)<br>3.3               | (7a)<br>3.4                              | (7b)<br>3.5         | (8)<br>4.1.4 | (9)<br>4.1.4 | (10)<br>4.1.4 | (11)<br>4.1.4 |
| 3169   | GAS SAMPLE, NON-PRESSURIZED, TOXIC, N.O.S., not refrigerated liquid | 2.3               | –                    | –              | 209                      | 0  | E0                  | P201         | –            | –             | –             |
| 3170   | ALUMINIUM SMELTING BY-PRODUCTS or ALUMINIUM REMELTING BY-PRODUCTS   | 4.3               | –                    | II             | 244                      | 500 g                                    | E2                  | P410         | PP31<br>PP40 | IBC07         | B4<br>B21     |
| 3170   | ALUMINIUM SMELTING BY-PRODUCTS or ALUMINIUM REMELTING BY-PRODUCTS   | 4.3               | –                    | III            | 223<br>244               | 1 kg                                     | E1                  | P002         | PP31         | IBC08         | B4            |
| △ 3171 | BATTERY-POWERED VEHICLE or BATTERY-POWERED EQUIPMENT                | 9                 | –                    | –              | 388<br>961<br>962<br>971 | –  | –                   | –            | –            | –             | –             |
| 3172   | TOXINS, EXTRACTED FROM LIVING SOURCES, LIQUID, N.O.S.               | 6.1               | –                    | I              | 210<br>274               | 0  | E5                  | P001         | –            | –             | –             |
| 3172   | TOXINS, EXTRACTED FROM LIVING SOURCES, LIQUID, N.O.S.               | 6.1               | –                    | II             | 210<br>274               | 100 mL                                   | E4                  | P001         | –            | IBC02         | –             |
| 3172   | TOXINS, EXTRACTED FROM LIVING SOURCES, LIQUID, N.O.S.               | 6.1               | –                    | III            | 210<br>223<br>274        | 5 L                                      | E1                  | P001<br>LP01 | –            | IBC03         | –             |
| 3174   | TITANIUM DISULPHIDE   | 4.2               | –                    | III            | –                        | 0  | E1                  | P002<br>LP02 | PP31         | IBC08         | B3            |
| 3175   | SOLIDS CONTAINING FLAMMABLE LIQUID, N.O.S.                          | 4.1               | –                    | II             | 216<br>274               | 1 kg                                     | E2                  | P002         | PP9          | IBC06         | B21           |
| 3176   | FLAMMABLE SOLID, ORGANIC, MOLTEN, N.O.S.                            | 4.1               | –                    | II             | 274                      | 0  | E0                  | –            | –            | –             | –             |
| 3176   | FLAMMABLE SOLID, ORGANIC, MOLTEN, N.O.S.                            | 4.1               | –                    | III            | 223<br>274               | 0  | E0                  | –            | –            | –             | –             |
| 3178   | FLAMMABLE SOLID, INORGANIC, N.O.S.                                  | 4.1               | –                    | II             | 274                      | 1 kg                                     | E2                  | P002         | –            | IBC08         | B4<br>B21     |
| 3178   | FLAMMABLE SOLID, INORGANIC, N.O.S.                                  | 4.1               | –                    | III            | 223<br>274               | 5 kg                                     | E1                  | P002<br>LP02 | –            | IBC08         | B3            |
| 3179   | FLAMMABLE SOLID, TOXIC, INORGANIC, N.O.S.                           | 4.1               | 6.1                  | II             | 274                      | 1 kg                                     | E2                  | P002         | –            | IBC06         | B21           |
| 3179   | FLAMMABLE SOLID, TOXIC, INORGANIC, N.O.S.                           | 4.1               | 6.1                  | III            | 223<br>274               | 5 kg                                     | E1                  | P002         | –            | IBC06         | –             |
| 3180   | FLAMMABLE SOLID, CORROSIVE, INORGANIC, N.O.S.                       | 4.1               | 8                    | II             | 274                      | 1 kg                                     | E2                  | P002         | –            | IBC06         | B21           |
| 3180   | FLAMMABLE SOLID, CORROSIVE, INORGANIC, N.O.S.                       | 4.1               | 8                    | III            | 223<br>274               | 5 kg                                     | E1                  | P002         | –            | IBC06         | –             |
| 3181   | METAL SALTS OF ORGANIC COMPOUNDS, FLAMMABLE, N.O.S.                 | 4.1               | –                    | II             | 274                      | 1 kg                                     | E2                  | P002         | PP31         | IBC08         | B4<br>B21     |
| 3181   | METAL SALTS OF ORGANIC COMPOUNDS, FLAMMABLE, N.O.S.                 | 4.1               | –                    | III            | 223<br>274               | 5 kg                                     | E1                  | P002<br>LP02 | PP31         | IBC08         | B3            |
| 3182   | METAL HYDRIDES, FLAMMABLE, N.O.S.                                   | 4.1               | –                    | II             | 274                      | 1 kg                                     | E2                  | P410         | PP31<br>PP40 | IBC04         | –             |

| UN No. | Portable tanks and bulk containers |               | EmS                    | Stowage and handling    | Segregation      | Properties and observations   | UN No. |
|--------|------------------------------------|---------------|------------------------|-------------------------|------------------|---|--------|
|        | Tank instructions                  | Provisions    |                        |                         |                  |   |        |
| (12)   | (13)<br>4.2.5<br>4.3               | (14)<br>4.2.5 | (15)<br>5.4.3.4<br>7.8 | (16a)<br>7.1<br>7.3–7.7 | (16b)<br>7.2–7.7 | (17)  | (18)   |
| –      | –                                  | –             | F-C, S-U               | Category D              | –                | –   | 3169   |
| –      | T3<br>BK2                          | TP33          | F-G, S-P               | Category B<br>SW5<br>H1 | SGG15<br>SG26    | Grey powder or lumps with some metallic inclusions. Contact with water may cause heating with possible evolution of flammable and toxic gases such as hydrogen and ammonia. This entry includes e.g. aluminium dross, aluminium skimmings, spent cathodes, spent potliner and aluminium salt slags. | 3170   |
| –      | T1<br>BK2                          | TP33          | F-G, S-P               | Category B<br>SW5<br>H1 | SGG15<br>SG26    | See entry above.  | 3170   |
| –      | –                                  | –             | F-A, S-I               | Category A              | –                | This entry applies to vehicles and equipment powered by wet batteries, metallic sodium batteries or sodium alloy batteries with the batteries installed.  | 3171   |
| –      | –                                  | –             | F-A, S-A               | Category B              | –                | Toxins from plant, animal or bacterial sources which contain infectious substances or toxins that are contained in infectious substances should be classified in class 6.2. Toxic if swallowed, by skin contact or by inhalation.   | 3172   |
| –      | –                                  | –             | F-A, S-A               | Category B              | –                | See entry above.  | 3172   |
| –      | –                                  | –             | F-A, S-A               | Category A              | –                | See entry above.  | 3172   |
| –      | T1                                 | TP33          | F-A, S-J               | Category A              | SGG7             | Yellow or grey powder with an unpleasant odour. In contact with water slowly evolves hydrogen sulphide gas.   | 3174   |
| –      | T3<br>BK2                          | TP33          | F-A, S-I               | Category B              | –                | Mixtures of non-dangerous solids (such as soil, sand, production materials, etc.) and flammable liquids.  | 3175   |
| –      | T3                                 | TP3<br>TP26   | F-A, S-H               | Category C              | –                | Shipped molten above its melting point.   | 3176   |
| –      | T1                                 | TP3<br>TP26   | F-A, S-H               | Category C              | –                | See entry above.  | 3176   |
| –      | T3                                 | TP33          | F-A, S-G               | Category B              | –                | –   | 3178   |
| –      | T1                                 | TP33          | F-A, S-G               | Category B              | –                | –   | 3178   |
| –      | T3                                 | TP33          | F-A, S-G               | Category B<br>SW2       | –                | Toxic if swallowed, by skin contact or by dust inhalation. Should be handled with care to minimize exposure, particularly to dust.  | 3179   |
| –      | T1                                 | TP33          | F-A, S-G               | Category B<br>SW2       | –                | See entry above.  | 3179   |
| –      | T3                                 | TP33          | F-A, S-G               | Category D<br>SW2       | –                | Causes burns to skin, eyes and mucous membranes.  | 3180   |
| –      | T1                                 | TP33          | F-A, S-G               | Category D<br>SW2       | –                | See entry above.  | 3180   |
| –      | T3                                 | TP33          | F-A, S-I               | Category B<br>SW2       | SGG7             | Decomposes in water. Liable to spontaneous heating. Irritating to skin and mucous membranes.  | 3181   |
| –      | T1                                 | TP33          | F-A, S-I               | Category B<br>SW2       | SGG7             | See entry above.  | 3181   |
| –      | T3                                 | TP33          | F-A, S-G               | Category E              | –                | –   | 3182   |



Part 3 – Dangerous Goods List, special provisions and exceptions

Chapter 3.2 – Dangerous Goods List

| UN No. | Proper shipping name (PSN)                        | Class or division | Subsidiary hazard(s) | Packing group  | Special provisions | Limited and excepted quantity provisions |                     | Packing      |              | IBC           |               |
|--------|---|-------------------|----------------------|----------------|--------------------|--|---------------------|--------------|--------------|---------------|---------------|
|        |   |                   |                      |                |                    | Limited quantities                       | Excepted quantities | Instructions | Provisions   | Instructions  | Provisions    |
| (1)    | (2)<br>3.1.2                                      | (3)<br>2.0        | (4)<br>2.0           | (5)<br>2.0.1.3 | (6)<br>3.3         | (7a)<br>3.4                              | (7b)<br>3.5         | (8)<br>4.1.4 | (9)<br>4.1.4 | (10)<br>4.1.4 | (11)<br>4.1.4 |
| 3182   | METAL HYDRIDES, FLAMMABLE, N.O.S.                 | 4.1               | –                    | III            | 223<br>274         | 5 kg                                     | E1                  | P002         | PP31         | IBC04         | –             |
| 3183   | SELF-HEATING LIQUID, ORGANIC, N.O.S.              | 4.2               | –                    | II             | 274                | 0  | E2                  | P001         | PP31         | IBC02         | –             |
| 3183   | SELF-HEATING LIQUID, ORGANIC, N.O.S.              | 4.2               | –                    | III            | 223<br>274         | 0  | E1                  | P001         | PP31         | IBC02         | –             |
| 3184   | SELF-HEATING LIQUID, TOXIC, ORGANIC, N.O.S.       | 4.2               | 6.1                  | II             | 274                | 0  | E2                  | P402         | PP31         | IBC02         | –             |
| 3184   | SELF-HEATING LIQUID, TOXIC, ORGANIC, N.O.S.       | 4.2               | 6.1                  | III            | 223<br>274         | 0  | E1                  | P001         | PP31         | IBC02         | –             |
| 3185   | SELF-HEATING LIQUID, CORROSIVE, ORGANIC, N.O.S.   | 4.2               | 8                    | II             | 274                | 0  | E2                  | P402         | PP31         | IBC02         | –             |
| 3185   | SELF-HEATING LIQUID, CORROSIVE, ORGANIC, N.O.S.   | 4.2               | 8                    | III            | 223<br>274         | 0  | E1                  | P001         | PP31         | IBC02         | –             |
| 3186   | SELF-HEATING LIQUID, INORGANIC, N.O.S.            | 4.2               | –                    | II             | 274                | 0  | E2                  | P001         | PP31         | IBC02         | –             |
| 3186   | SELF-HEATING LIQUID, INORGANIC, N.O.S.            | 4.2               | –                    | III            | 223<br>274         | 0  | E1                  | P001         | PP31         | IBC02         | –             |
| 3187   | SELF-HEATING LIQUID, TOXIC, INORGANIC, N.O.S.     | 4.2               | 6.1                  | II             | 274                | 0  | E2                  | P402         | PP31         | IBC02         | –             |
| 3187   | SELF-HEATING LIQUID, TOXIC, INORGANIC, N.O.S.     | 4.2               | 6.1                  | III            | 223<br>274         | 0  | E1                  | P001         | PP31         | IBC02         | –             |
| 3188   | SELF-HEATING LIQUID, CORROSIVE, INORGANIC, N.O.S. | 4.2               | 8                    | II             | 274                | 0  | E2                  | P402         | PP31         | IBC02         | –             |
| 3188   | SELF-HEATING LIQUID, CORROSIVE, INORGANIC, N.O.S. | 4.2               | 8                    | III            | 223<br>274         | 0  | E1                  | P001         | PP31         | IBC02         | –             |
| 3189   | METAL POWDER, SELF-HEATING, N.O.S.                | 4.2               | –                    | II             | 274                | 0  | E2                  | P410         | PP31         | IBC06         | B21           |
| 3189   | METAL POWDER, SELF-HEATING, N.O.S.                | 4.2               | –                    | III            | 223<br>274         | 0  | E1                  | P002<br>LP02 | PP31<br>L4   | IBC08         | B4            |
| 3190   | SELF-HEATING SOLID, INORGANIC, N.O.S.             | 4.2               | –                    | II             | 274                | 0  | E2                  | P410         | PP31         | IBC06         | B21           |
| 3190   | SELF-HEATING SOLID, INORGANIC, N.O.S.             | 4.2               | –                    | III            | 223<br>274         | 0  | E1                  | P002<br>LP02 | PP31         | IBC08         | B3            |
| 3191   | SELF-HEATING SOLID, TOXIC, INORGANIC, N.O.S.      | 4.2               | 6.1                  | II             | 274                | 0  | E2                  | P410         | –            | IBC05         | B21           |
| 3191   | SELF-HEATING SOLID, TOXIC, INORGANIC, N.O.S.      | 4.2               | 6.1                  | III            | 223<br>274         | 0  | E1                  | P002         | –            | IBC08         | B3            |
| 3192   | SELF-HEATING SOLID, CORROSIVE, INORGANIC, N.O.S.  | 4.2               | 8                    | II             | 274                | 0  | E2                  | P410         | –            | IBC05         | B21           |
| 3192   | SELF-HEATING SOLID, CORROSIVE, INORGANIC, N.O.S.  | 4.2               | 8                    | III            | 274                | 0  | E1                  | P002         | –            | IBC08         | B3            |
| 3194   | PYROPHORIC LIQUID, INORGANIC, N.O.S.              | 4.2               | –                    | I              | 274                | 0  | E0                  | P400         | –            | –             | –             |
| 3200   | PYROPHORIC SOLID, INORGANIC, N.O.S.               | 4.2               | –                    | I              | 274                | 0  | E0                  | P404         | PP31         | –             | –             |
| 3205   | ALKALINE EARTH METAL ALCOHOLATES, N.O.S.          | 4.2               | –                    | II             | 183<br>274         | 0  | E2                  | P410         | PP31         | IBC06         | B21           |

| UN No. | Portable tanks and bulk containers |               | EmS                    | Stowage and handling    | Segregation           | Properties and observations   | UN No. |
|--------|------------------------------------|---------------|------------------------|-------------------------|-----------------------|---|--------|
|        | Tank instructions                  | Provisions    |                        |                         |                       |   |        |
| (12)   | (13)<br>4.2.5<br>4.3               | (14)<br>4.2.5 | (15)<br>5.4.3.4<br>7.8 | (16a)<br>7.1<br>7.3–7.7 | (16b)<br>7.2–7.7      | (17)  | (18)   |
| –      | T1                                 | TP33          | F-A, S-G               | Category E              | –                     | –   | 3182   |
| –      | –                                  | –             | F-A, S-J               | Category C              | –                     | –   | 3183   |
| –      | –                                  | –             | F-A, S-J               | Category C              | –                     | –   | 3183   |
| –      | –                                  | –             | F-A, S-J               | Category C              | –                     | –   | 3184   |
| –      | –                                  | –             | F-A, S-J               | Category C              | –                     | –   | 3184   |
| –      | –                                  | –             | F-A, S-J               | Category C              | –                     | –   | 3185   |
| –      | –                                  | –             | F-A, S-J               | Category C              | –                     | –   | 3185   |
| –      | –                                  | –             | F-A, S-J               | Category C              | –                     | –   | 3186   |
| –      | –                                  | –             | F-A, S-J               | Category C              | –                     | –   | 3186   |
| –      | –                                  | –             | F-A, S-J               | Category C              | –                     | –   | 3187   |
| –      | –                                  | –             | F-A, S-J               | Category C              | –                     | –   | 3187   |
| –      | –                                  | –             | F-A, S-J               | Category C              | –                     | –   | 3188   |
| –      | –                                  | –             | F-A, S-J               | Category C              | –                     | –   | 3188   |
| –      | T3                                 | TP33          | F-G, S-J               | Category C<br>H1        | SGG7<br>SGG15<br>SG26 | Forms explosive mixtures with oxidizing substances.   | 3189   |
| –      | T1                                 | TP33          | F-G, S-J               | Category C<br>H1        | SGG7<br>SGG15<br>SG26 | See entry above.  | 3189   |
| –      | T3                                 | TP33          | F-A, S-J               | Category C              | –                     | Liable to self-heating or spontaneous combustion.   | 3190   |
| –      | T1                                 | TP33          | F-A, S-J               | Category C              | –                     | See entry above.  | 3190   |
| –      | T3                                 | TP33          | F-A, S-J               | Category C              | –                     | –   | 3191   |
| –      | T1                                 | TP33          | F-A, S-J               | Category C              | –                     | –   | 3191   |
| –      | T3                                 | TP33          | F-A, S-J               | Category C              | –                     | –   | 3192   |
| –      | T1                                 | TP33          | F-A, S-J               | Category C              | –                     | –   | 3192   |
| –      | –                                  | –             | F-G, S-M               | Category D<br>H1        | SG26<br>SG63          | Highly flammable liquids, may ignite spontaneously in moist air. In contact with air, evolve irritating and slightly toxic fumes. | 3194   |
| –      | T21                                | TP7<br>TP33   | F-G, S-M               | Category D<br>H1        | SG26                  | Liable to ignite spontaneously in air. If shaken, may produce sparks. In contact with water, evolve hydrogen, a flammable gas.    | 3200   |
| –      | T3                                 | TP33          | F-A, S-J               | Category B              | –                     | Free-flowing hygroscopic powders. Irritating to skin, eyes and mucous membranes.  | 3205   |

Part 3 – Dangerous Goods List, special provisions and exceptions

Chapter 3.2 – Dangerous Goods List

| UN No. | Proper shipping name (PSN)                                | Class or division | Subsidiary hazard(s) | Packing group  | Special provisions       | Limited and excepted quantity provisions |                     | Packing      |              | IBC           |               |
|--------|---|-------------------|----------------------|----------------|--------------------------|--|---------------------|--------------|--------------|---------------|---------------|
|        |   |                   |                      |                |                          | Limited quantities                       | Excepted quantities | Instructions | Provisions   | Instructions  | Provisions    |
| (1)    | (2)<br>3.1.2  | (3)<br>2.0        | (4)<br>2.0           | (5)<br>2.0.1.3 | (6)<br>3.3               | (7a)<br>3.4                              | (7b)<br>3.5         | (8)<br>4.1.4 | (9)<br>4.1.4 | (10)<br>4.1.4 | (11)<br>4.1.4 |
| 3205   | ALKALINE EARTH METAL ALCOHOLATES, N.O.S.                  | 4.2               | –                    | III            | 183<br>223<br>274        | 0  | E1                  | P002<br>LP02 | PP31         | IBC08         | B3            |
| 3206   | ALKALI METAL ALCOHOLATES, SELF-HEATING, CORROSIVE, N.O.S. | 4.2               | 8                    | II             | 182<br>274               | 0  | E2                  | P410         | PP31         | IBC05         | B21           |
| 3206   | ALKALI METAL ALCOHOLATES, SELF-HEATING, CORROSIVE, N.O.S. | 4.2               | 8                    | III            | 182<br>223<br>274        | 0  | E1                  | P002         | PP31         | IBC08         | B3            |
| 3208   | METALLIC SUBSTANCE, WATER-REACTIVE, N.O.S.                | 4.3               | –                    | I              | 274                      | 0  | E0                  | P403         | PP31         | IBC99         | –             |
| 3208   | METALLIC SUBSTANCE, WATER-REACTIVE, N.O.S.                | 4.3               | –                    | II             | 274                      | 500 g                                    | E2                  | P410         | PP31<br>PP40 | IBC07         | B4<br>B21     |
| 3208   | METALLIC SUBSTANCE, WATER-REACTIVE, N.O.S.                | 4.3               | –                    | III            | 223<br>274               | 1 kg                                     | E1                  | P410         | PP31         | IBC08         | B4            |
| 3209   | METALLIC SUBSTANCE, WATER-REACTIVE, SELF-HEATING, N.O.S.  | 4.3               | 4.2                  | I              | 274                      | 0  | E0                  | P403         | PP31         | –             | –             |
| 3209   | METALLIC SUBSTANCE, WATER-REACTIVE, SELF-HEATING, N.O.S.  | 4.3               | 4.2                  | II             | 274                      | 0  | E0                  | P410         | PP31<br>PP40 | IBC05         | B21           |
| 3209   | METALLIC SUBSTANCE, WATER-REACTIVE, SELF-HEATING, N.O.S.  | 4.3               | 4.2                  | III            | 223<br>274               | 0  | E1                  | P410         | PP31         | IBC08         | B4            |
| 3210   | CHLORATES, INORGANIC, AQUEOUS SOLUTION, N.O.S.            | 5.1               | –                    | II             | 274<br>351               | 1 L                                      | E2                  | P504         | –            | IBC02         | –             |
| 3210   | CHLORATES, INORGANIC, AQUEOUS SOLUTION, N.O.S.            | 5.1               | –                    | III            | 223<br>274<br>351        | 5 L                                      | E1                  | P504         | –            | IBC02         | –             |
| 3211   | PERCHLORATES, INORGANIC, AQUEOUS SOLUTION, N.O.S.         | 5.1               | –                    | II             | –                        | 1 L                                      | E2                  | P504         | –            | IBC02         | –             |
| 3211   | PERCHLORATES, INORGANIC, AQUEOUS SOLUTION, N.O.S.         | 5.1               | –                    | III            | 223                      | 5 L                                      | E1                  | P504         | –            | IBC02         | –             |
| 3212   | HYPOCHLORITES, INORGANIC, N.O.S.                          | 5.1               | –                    | II             | 274<br>349<br>900<br>903 | 1 kg                                     | E2                  | P002         | –            | IBC08         | B4<br>B21     |

| UN No. | Portable tanks and bulk containers |               | EmS                    | Stowage and handling      | Segregation                                  | Properties and observations  | UN No. |
|--------|------------------------------------|---------------|------------------------|---------------------------|--|--|--------|
|        | Tank instructions                  | Provisions    |                        |                           |  |  |        |
| (12)   | (13)<br>4.2.5<br>4.3               | (14)<br>4.2.5 | (15)<br>5.4.3.4<br>7.8 | (16a)<br>7.1<br>7.3–7.7   | (16b)<br>7.2–7.7                             | (17)   | (18)   |
| –      | T1                                 | TP33          | F-A, S-J               | Category B                | –  | Free-flowing hygroscopic powders. Irritating to skin, eyes and mucous membranes.   | 3205   |
| –      | T3                                 | TP33          | F-A, S-J               | Category B                | SGG18<br>SG35                                | Free-flowing hygroscopic powder. Cause burns to skin, eyes and mucous membranes.   | 3206   |
| –      | T1                                 | TP33          | F-A, S-J               | Category B                | SGG18<br>SG35                                | See entry above.   | 3206   |
| –      | –                                  | –             | F-G, S-N               | Category E<br>SW2<br>H1   | SG26   | –  | 3208   |
| –      | T3                                 | TP33          | F-G, S-N               | Category E<br>SW2<br>H1   | SG26   | –  | 3208   |
| –      | T1                                 | TP33          | F-G, S-N               | Category E<br>SW2<br>H1   | SG26   | –  | 3208   |
| –      | –                                  | –             | F-G, S-N               | Category E<br>SW2<br>H1   | SG26   | –  | 3209   |
| –      | T3                                 | TP33          | F-G, S-N               | Category E<br>SW2<br>H1   | SG26   | –  | 3209   |
| –      | T1                                 | TP33          | F-G, S-N               | Category E<br>SW2<br>H1   | SG26   | –  | 3209   |
| –      | T4                                 | TP1           | F-H, S-Q               | Category B                | SG38<br>SG49<br>SG62                         | When involved in a fire, may cause an explosion. Leakage and subsequent evaporation of the water of the solutions may present increased dangers as follows:<br>.1 in contact with combustible material (particularly with fibrous material such as jute, cotton or sisal) or sulphur, danger of spontaneous combustion;<br>.2 in contact with ammonium compounds, powdered metals or oils, danger of explosion.<br>Transport of ammonium chlorate, aqueous solution is <b>prohibited</b> . | 3210   |
| –      | T4                                 | TP1           | F-H, S-Q               | Category B                | SG38<br>SG49<br>SG62                         | See entry above.   | 3210   |
| –      | T4                                 | TP1           | F-H, S-Q               | Category B                | SGG13<br>SG38<br>SG49<br>SG62                | When involved in a fire, may cause an explosion. Leakage and subsequent evaporation of the water of the solutions may present increased dangers as follows:<br>.1 in contact with combustible material (particularly with fibrous material such as jute, cotton or sisal) or sulphur, danger of spontaneous combustion;<br>.2 in contact with ammonium compounds, powdered metals or oils, danger of explosion.  | 3211   |
| –      | T4                                 | TP1           | F-H, S-Q               | Category B                | SGG13<br>SG38<br>SG49<br>SG62                | See entry above.   | 3211   |
| –      | T3                                 | TP33          | F-H, S-Q               | Category D<br>SW1<br>SW17 | SGG8<br>SG35<br>SG38<br>SG49<br>SG53<br>SG60 | Solids. Critical ambient temperature of decomposition may be as low as 60°C. May cause fire in contact with organic material or ammonium compounds. React with acids, evolving chlorine, an irritating, corrosive and toxic gas. In the presence of moisture, corrosive to most metals. Dust irritates mucous membranes. Transport of ammonium hypochlorite and mixtures of a hypochlorite with an ammonium salt is <b>prohibited</b> .  | 3212   |

Part 3 – Dangerous Goods List, special provisions and exceptions

Chapter 3.2 – Dangerous Goods List

| UN No. | Proper shipping name (PSN)                         | Class or division | Subsidiary hazard(s) | Packing group  | Special provisions | Limited and excepted quantity provisions |                     | Packing      |              | IBC           |               |
|--------|--|-------------------|----------------------|----------------|--------------------|--|---------------------|--------------|--------------|---------------|---------------|
|        |  |                   |                      |                |                    | Limited quantities                       | Excepted quantities | Instructions | Provisions   | Instructions  | Provisions    |
| (1)    | (2)<br>3.1.2                                       | (3)<br>2.0        | (4)<br>2.0           | (5)<br>2.0.1.3 | (6)<br>3.3         | (7a)<br>3.4                              | (7b)<br>3.5         | (8)<br>4.1.4 | (9)<br>4.1.4 | (10)<br>4.1.4 | (11)<br>4.1.4 |
| 3213   | BROMATES, INORGANIC, AQUEOUS SOLUTION, N.O.S.      | 5.1               | –                    | II             | 274<br>350         | 1 L                                      | E2                  | P504         | –            | IBC02         | –             |
| 3213   | BROMATES, INORGANIC, AQUEOUS SOLUTION, N.O.S.      | 5.1               | –                    | III            | 223<br>274<br>350  | 5 L                                      | E1                  | P504         | –            | IBC02         | –             |
| 3214   | PERMANGANATES, INORGANIC, AQUEOUS SOLUTION, N.O.S. | 5.1               | –                    | II             | 274<br>353         | 1 L                                      | E2                  | P504         | –            | IBC02         | –             |
| 3215   | PERSULPHATES, INORGANIC, N.O.S.                    | 5.1               | –                    | III            | –                  | 5 kg                                     | E1                  | P002<br>LP02 | –            | IBC08         | B3            |
| 3216   | PERSULPHATES, INORGANIC, AQUEOUS SOLUTION, N.O.S.  | 5.1               | –                    | III            | –                  | 5 L                                      | E1                  | P504         | –            | IBC02         | –             |
| 3218   | NITRATES, INORGANIC, AQUEOUS SOLUTION, N.O.S.      | 5.1               | –                    | II             | 270                | 1 L                                      | E2                  | P504         | –            | IBC02         | –             |
| 3218   | NITRATES, INORGANIC, AQUEOUS SOLUTION, N.O.S.      | 5.1               | –                    | III            | 223<br>270         | 5 L                                      | E1                  | P504         | –            | IBC02         | –             |
| 3219   | NITRITES, INORGANIC, AQUEOUS SOLUTION, N.O.S.      | 5.1               | –                    | II             | 274<br>900         | 1 L                                      | E2                  | P504         | –            | IBC01         | –             |
| 3219   | NITRITES, INORGANIC, AQUEOUS SOLUTION, N.O.S.      | 5.1               | –                    | III            | 223<br>274<br>900  | 5 L                                      | E1                  | P504         | –            | IBC02         | –             |

| UN No. | Portable tanks and bulk containers |               | EmS                    | Stowage and handling    | Segregation                           | Properties and observations  | UN No. |
|--------|------------------------------------|---------------|------------------------|-------------------------|---------------------------------------|--|--------|
|        | Tank instructions                  | Provisions    |                        |                         |                                       |  |        |
| (12)   | (13)<br>4.2.5<br>4.3               | (14)<br>4.2.5 | (15)<br>5.4.3.4<br>7.8 | (16a)<br>7.1<br>7.3–7.7 | (16b)<br>7.2–7.7                      | (17)   | (18)   |
| –      | T4                                 | TP1           | F-H, S-Q               | Category B              | SGG3<br>SG38<br>SG49<br>SG62          | When involved in a fire, may cause an explosion. Leakage and subsequent evaporation of the water of the solutions may present increased dangers as follows:<br>.1 in contact with combustible material (particularly with fibrous material such as jute, cotton or sisal) or sulphur, danger of spontaneous combustion;<br>.2 in contact with ammonium compounds, powdered metals or oils, danger of explosion.<br>Transport of ammonium bromate, aqueous solution is <b>prohibited</b> .      | 3213   |
| –      | T4                                 | TP1           | F-H, S-Q               | Category B              | SGG3<br>SG38<br>SG49<br>SG62          | See entry above.   | 3213   |
| –      | T4                                 | TP1           | F-H, S-Q               | Category D              | SGG14<br>SG38<br>SG49<br>SG60<br>SG62 | When involved in a fire, may cause an explosion. Leakage and subsequent evaporation of the water of the solutions may present increased dangers as follows:<br>.1 in contact with combustible material (particularly with fibrous material such as jute, cotton or sisal) or sulphur, danger of spontaneous combustion;<br>.2 in contact with ammonium compounds, powdered metals or oils, danger of explosion.<br>Transport of ammonium permanganate, aqueous solution is <b>prohibited</b> . | 3214   |
| –      | T1                                 | TP33          | F-A, S-Q               | Category A              | SG40<br>SG49                          | Solids. Solid mixtures with combustible material are sensitive to friction and are liable to ignite. React fiercely with cyanides when heated or by friction. May form explosive mixture with powdered metals or ammonium compounds.   | 3215   |
| –      | T4                                 | TP1<br>TP29   | F-A, S-Q               | Category A              | SG38<br>SG49<br>SG62                  | When involved in a fire, may cause an explosion. Leakage and subsequent evaporation of the water of the solutions may present increased dangers as follows:<br>.1 in contact with combustible material (particularly with fibrous material such as jute, cotton or sisal) or sulphur, danger of spontaneous combustion;<br>.2 in contact with ammonium compounds, powdered metals or oils, danger of explosion.  | 3216   |
| –      | T4                                 | TP1           | F-A, S-Q               | Category B              | SG38<br>SG49<br>SG62                  | When involved in a fire, may cause an explosion. Leakage and subsequent evaporation of the water of the solutions may present increased dangers as follows:<br>.1 in contact with combustible material (particularly with fibrous material such as jute, cotton or sisal) or sulphur, danger of spontaneous combustion;<br>.2 in contact with ammonium compounds, powdered metals or oils, danger of explosion.  | 3218   |
| –      | T4                                 | TP1           | F-A, S-Q               | Category B              | SG38<br>SG49<br>SG62                  | See entry above.   | 3218   |
| –      | T4                                 | TP1           | F-A, S-Q               | Category B              | SGG12<br>SG38<br>SG49<br>SG62         | When involved in a fire, may cause an explosion. Leakage and subsequent evaporation of the water of the solutions may present increased dangers as follows:<br>.1 in contact with combustible material (particularly with fibrous material such as jute, cotton or sisal) or sulphur, danger of spontaneous combustion;<br>.2 in contact with ammonium compounds, powdered metals or oils, danger of explosion.<br>Transport of ammonium nitrites, aqueous solution is <b>prohibited</b> .     | 3219   |
| –      | T4                                 | TP1           | F-A, S-Q               | Category B              | SGG12<br>SG38<br>SG49<br>SG62         | See entry above.   | 3219   |

Part 3 – Dangerous Goods List, special provisions and exceptions

Chapter 3.2 – Dangerous Goods List

| UN No. | Proper shipping name (PSN)                          | Class or division | Subsidiary hazard(s) | Packing group  | Special provisions       | Limited and excepted quantity provisions |                          | Packing          |                      | IBC               |                 |
|--------|---|-------------------|----------------------|----------------|--------------------------|--|--------------------------|------------------|----------------------|-------------------|-----------------|
|        |   |                   |                      |                |                          | Limited quantities (7a)                  | Excepted quantities (7b) | Instructions (8) | Provisions (9)       | Instructions (10) | Provisions (11) |
| (1)    | (2)<br>3.1.2  | (3)<br>2.0        | (4)<br>2.0           | (5)<br>2.0.1.3 | (6)<br>3.3               | (7a)<br>3.4                              | (7b)<br>3.5              | (8)<br>4.1.4     | (9)<br>4.1.4         | (10)<br>4.1.4     | (11)<br>4.1.4   |
| 3220   | PENTAFLUOROETHANE (REFRIGERANT GAS R 125)           | 2.2               | –                    | –              | –                        | 120 mL                                   | E1                       | P200             | –                    | –                 | –               |
| 3221   | SELF-REACTIVE LIQUID TYPE B                         | 4.1               | See SP181            | –              | 181<br>274               | 25 mL                                    | E0                       | P520             | PP21                 | –                 | –               |
| 3222   | SELF-REACTIVE SOLID TYPE B                          | 4.1               | See SP181            | –              | 181<br>274               | 100 g                                    | E0                       | P520             | PP21                 | –                 | –               |
| 3223   | SELF-REACTIVE LIQUID TYPE C                         | 4.1               | –                    | –              | 274                      | 25 mL                                    | E0                       | P520             | PP21<br>PP94<br>PP95 | –                 | –               |
| 3224   | SELF-REACTIVE SOLID TYPE C                          | 4.1               | –                    | –              | 274                      | 100 g                                    | E0                       | P520             | PP21<br>PP94<br>PP95 | –                 | –               |
| 3225   | SELF-REACTIVE LIQUID TYPE D                         | 4.1               | –                    | –              | 274                      | 125 mL                                   | E0                       | P520             | –                    | –                 | –               |
| 3226   | SELF-REACTIVE SOLID TYPE D                          | 4.1               | –                    | –              | 274                      | 500 g                                    | E0                       | P520             | –                    | –                 | –               |
| 3227   | SELF-REACTIVE LIQUID TYPE E                         | 4.1               | –                    | –              | 274                      | 125 mL                                   | E0                       | P520             | –                    | –                 | –               |
| 3228   | SELF-REACTIVE SOLID TYPE E                          | 4.1               | –                    | –              | 274                      | 500 g                                    | E0                       | P520             | –                    | –                 | –               |
| 3229   | SELF-REACTIVE LIQUID TYPE F                         | 4.1               | –                    | –              | 274                      | 125 mL                                   | E0                       | P520             | –                    | IBC99             | –               |
| 3230   | SELF-REACTIVE SOLID TYPE F                          | 4.1               | –                    | –              | 274                      | 500 g                                    | E0                       | P520             | –                    | IBC99             | –               |
| 3231   | SELF-REACTIVE LIQUID TYPE B, TEMPERATURE CONTROLLED | 4.1               | See SP181            | –              | 181<br>194<br>274<br>923 | 0  | E0                       | P520             | PP21                 | –                 | –               |

| UN No. | Portable tanks and bulk containers |                 | EmS                    | Stowage and handling    | Segregation         | Properties and observations  | UN No. |
|--------|------------------------------------|-----------------|------------------------|-------------------------|---------------------|--|--------|
|        | Tank instructions (12)             | Provisions (14) |                        |                         |                     |  |        |
| (12)   | (13)<br>4.2.5<br>4.3               | (14)<br>4.2.5   | (15)<br>5.4.3.4<br>7.8 | (16a)<br>7.1<br>7.3–7.7 | (16b)<br>7.2–7.7    | (17)   | (18)   |
| –      | T50                                | –               | F-C, S-V               | Category A              | –                   | Liquefied, non-flammable gas with a mild ether-like odour. Much heavier than air (4.2).  | 3220   |
| –      | –                                  | –               | F-J, S-G               | Category D SW1          | SG1<br>SG35<br>SG36 | May explode at elevated temperatures or in a fire. Burns vigorously. Immiscible with water. Contact with alkalis or acids may cause dangerous decomposition. The products of combustion or self-accelerating decomposition may be toxic by inhalation.   | 3221   |
| –      | –                                  | –               | F-J, S-G               | Category D SW1          | SG1<br>SG35<br>SG36 | May explode at elevated temperatures or in a fire. Burns vigorously. Insoluble in water. Contact with alkalis or acids may cause dangerous decomposition. The products of combustion or self-accelerating decomposition may be toxic by inhalation.  | 3222   |
| –      | –                                  | –               | F-J, S-G               | Category D SW1          | SG35<br>SG36        | May decompose violently at elevated temperatures or in a fire. Burns vigorously. Immiscible with water. Contact with alkalis or acids may cause dangerous decomposition. The products of combustion or self-accelerating decomposition may be toxic by inhalation.   | 3223   |
| –      | –                                  | –               | F-J, S-G               | Category D SW1          | SG35<br>SG36        | May decompose violently at elevated temperatures or in a fire. Burns vigorously. Insoluble in water. Contact with alkalis or acids may cause dangerous decomposition. The products of combustion or self-accelerating decomposition may be toxic by inhalation.  | 3224   |
| –      | –                                  | –               | F-J, S-G               | Category D SW1          | SG35<br>SG36        | Decomposes at elevated temperatures or in a fire. Burns vigorously. Immiscible with water. Contact with alkalis or acids may cause dangerous decomposition. The products of combustion or self-accelerating decomposition may be toxic by inhalation.  | 3225   |
| –      | –                                  | –               | F-J, S-G               | Category D SW1          | SG35<br>SG36        | Decomposes at elevated temperatures or in a fire. Burns vigorously. Contact with alkalis or acids may cause dangerous decomposition. The products of combustion or self-accelerating decomposition may be toxic by inhalation. Insoluble in water except:<br>4-(BENZYL(ETHYL)AMINO)-3-ETHOXYBENZENEDIAZONIUM ZINC CHLORIDE<br>3-CHLORO-4-DIETHYLAMINO BENZENEDIAZONIUM ZINC CHLORIDE<br>4-DIPROPYLAMINO BENZENEDIAZONIUM ZINC CHLORIDE<br>SODIUM 2-DIAZO-1-NAPHTHOL-4-SULPHONATE<br>SODIUM 2-DIAZO-1-NAPHTHOL-5-SULPHONATE | 3226   |
| –      | –                                  | –               | F-J, S-G               | Category D SW1          | SG35<br>SG36        | Decomposes at elevated temperatures or in a fire. Burns vigorously. Immiscible with water. Contact with alkalis or acids may cause dangerous decomposition. The products of combustion or self-accelerating decomposition may be toxic by inhalation.  | 3227   |
| –      | –                                  | –               | F-J, S-G               | Category D SW1          | SG35<br>SG36        | Decomposes at elevated temperatures or in a fire. Burns vigorously. Insoluble in water. Contact with alkalis or acids may cause dangerous decomposition. The products of combustion or self-accelerating decomposition may be toxic by inhalation.   | 3228   |
| –      | T23                                | –               | F-J, S-G               | Category D SW1          | SG35<br>SG36        | Decomposes at elevated temperatures or in a fire. Burns vigorously. Immiscible with water. Contact with alkalis or acids may cause dangerous decomposition. The products of combustion or self-accelerating decomposition may be toxic by inhalation.  | 3229   |
| –      | T23                                | –               | F-J, S-G               | Category D SW1          | SG35<br>SG36        | Decomposes at elevated temperatures or in a fire. Burns vigorously. Insoluble in water. Contact with alkalis or acids may cause dangerous decomposition. The products of combustion or self-accelerating decomposition may be toxic by inhalation.   | 3230   |
| –      | –                                  | –               | F-F, S-K               | Category D SW1<br>SW3   | SG1<br>SG35<br>SG36 | May explode at temperatures higher than the emergency temperature or in a fire. Burns vigorously. Immiscible with water. Contact with alkalis or acids may cause dangerous decomposition. The products of combustion or self-accelerating decomposition may be toxic by inhalation. Control and emergency temperatures for each formulation can be found in 2.4.2.3.2.3. The temperature should be checked regularly.  | 3231   |



| UN No. | Proper shipping name (PSN)                          | Class or division | Subsidiary hazard(s) | Packing group  | Special provisions       | Limited and excepted quantity provisions |                     | Packing      |              | IBC           |               |
|--------|---|-------------------|----------------------|----------------|--------------------------|--|---------------------|--------------|--------------|---------------|---------------|
|        |   |                   |                      |                |                          | Limited quantities                       | Excepted quantities | Instructions | Provisions   | Instructions  | Provisions    |
| (1)    | (2)<br>3.1.2  | (3)<br>2.0        | (4)<br>2.0           | (5)<br>2.0.1.3 | (6)<br>3.3               | (7a)<br>3.4                              | (7b)<br>3.5         | (8)<br>4.1.4 | (9)<br>4.1.4 | (10)<br>4.1.4 | (11)<br>4.1.4 |
| 3232   | SELF-REACTIVE SOLID TYPE B, TEMPERATURE CONTROLLED  | 4.1               | See SP181            | –              | 181<br>194<br>274<br>923 | 0  | E0                  | P520         | PP21         | –             | –             |
| 3233   | SELF-REACTIVE LIQUID TYPE C, TEMPERATURE CONTROLLED | 4.1               | –                    | –              | 194<br>274<br>923        | 0  | E0                  | P520         | PP21         | –             | –             |
| 3234   | SELF-REACTIVE SOLID TYPE C, TEMPERATURE CONTROLLED  | 4.1               | –                    | –              | 194<br>274<br>923        | 0  | E0                  | P520         | PP21         | –             | –             |
| 3235   | SELF-REACTIVE LIQUID TYPE D, TEMPERATURE CONTROLLED | 4.1               | –                    | –              | 194<br>274<br>923        | 0  | E0                  | P520         | –            | –             | –             |
| 3236   | SELF-REACTIVE SOLID TYPE D, TEMPERATURE CONTROLLED  | 4.1               | –                    | –              | 194<br>274<br>923        | 0  | E0                  | P520         | –            | –             | –             |
| 3237   | SELF-REACTIVE LIQUID TYPE E, TEMPERATURE CONTROLLED | 4.1               | –                    | –              | 194<br>274<br>923        | 0  | E0                  | P520         | –            | –             | –             |
| 3238   | SELF-REACTIVE SOLID TYPE E, TEMPERATURE CONTROLLED  | 4.1               | –                    | –              | 194<br>274<br>923        | 0  | E0                  | P520         | –            | –             | –             |
| 3239   | SELF-REACTIVE LIQUID TYPE F, TEMPERATURE CONTROLLED | 4.1               | –                    | –              | 194<br>274<br>923        | 0  | E0                  | P520         | –            | –             | –             |

| UN No. | Portable tanks and bulk containers |               | EmS                    | Stowage and handling     | Segregation         | Properties and observations   | UN No. |
|--------|------------------------------------|---------------|------------------------|--------------------------|---------------------|---|--------|
|        | Tank instructions                  | Provisions    |                        |                          |                     |   |        |
| (12)   | (13)<br>4.2.5<br>4.3               | (14)<br>4.2.5 | (15)<br>5.4.3.4<br>7.8 | (16a)<br>7.1<br>7.3–7.7  | (16b)<br>7.2–7.7    | (17)  | (18)   |
| –      | –                                  | –             | F-F, S-K               | Category D<br>SW1<br>SW3 | SG1<br>SG35<br>SG36 | May explode at temperatures higher than the emergency temperature or in a fire. Burns vigorously. Insoluble in water. Contact with alkalis or acids may cause dangerous decomposition. The products of combustion or self-accelerating decomposition may be toxic by inhalation. Control and emergency temperatures for each formulation can be found in 2.4.2.3.2.3. The temperature should be checked regularly.  | 3232   |
| –      | –                                  | –             | F-F, S-K               | Category D<br>SW1<br>SW3 | SG35<br>SG36        | May explode at temperatures higher than the emergency temperature or in a fire. Burns vigorously. Immiscible with water. Contact with alkalis or acids may cause dangerous decomposition. The products of combustion or self-accelerating decomposition may be toxic by inhalation. Control and emergency temperatures for each formulation can be found in 2.4.2.3.2.3. The temperature should be checked regularly.   | 3233   |
| –      | –                                  | –             | F-F, S-K               | Category D<br>SW1<br>SW3 | SG35<br>SG36        | May explode at temperatures higher than the emergency temperature or in a fire. Burns vigorously. Insoluble in water except: 3-METHYL-4-(PYRROLIDIN-1-YL)BENZENEDIAZONIUM TETRAFLUOROBORATE TETRAMINEPALLADIUM(II) NITRATE Contact with alkalis or acids may cause dangerous decomposition. The products of combustion or self-accelerating decomposition may be toxic by inhalation. Control and emergency temperatures for each formulation can be found in 2.4.2.3.2.3. The temperature should be checked regularly. | 3234   |
| –      | –                                  | –             | F-F, S-K               | Category D<br>SW1<br>SW3 | SG35<br>SG36        | Decomposes at temperatures higher than the emergency temperature or in a fire. Burns vigorously. Immiscible with water. Contact with alkalis or acids may cause dangerous decomposition. The products of combustion or self-accelerating decomposition may be toxic by inhalation.  | 3235   |
| –      | –                                  | –             | F-F, S-K               | Category D<br>SW1<br>SW3 | SG35<br>SG36        | Decomposes at temperatures higher than the emergency temperature or in a fire. Burns vigorously. Soluble in water except: AZODICARBONAMIDE FORMULATION TYPE D 2,2'-AZODI(2,4-DIMETHYL-4-METHOXYVALERONITRILE) 2,2'-AZODI(2,4-DIMETHYLVALERONITRILE) 2,2'-AZODI(2-METHYLBUTYRONITRILE) N-FORMYL-2-(NITROMETHYLENE)-1,3-PERHYDROTHIAZINE 4-NITROSOPHENOL Contact with alkalis or acids may cause dangerous decomposition. The products of combustion or self-accelerating decomposition may be toxic by inhalation.       | 3236   |
| –      | –                                  | –             | F-F, S-K               | Category D<br>SW1<br>SW3 | SG35<br>SG36        | Decomposes at temperatures higher than the emergency temperature or in a fire. Burns vigorously. Immiscible with water. Contact with alkalis or acids may cause dangerous decomposition. The products of combustion or self-accelerating decomposition may be toxic by inhalation. Control and emergency temperatures for each formulation can be found in 2.4.2.3.2.3. The temperature should be checked regularly.  | 3237   |
| –      | –                                  | –             | F-F, S-K               | Category D<br>SW1<br>SW3 | SG35<br>SG36        | Decomposes at temperatures higher than the emergency temperature or in a fire. Burns vigorously. Insoluble in water. Contact with alkalis or acids may cause dangerous decomposition. The products of combustion or self-accelerating decomposition may be toxic by inhalation. Control and emergency temperatures for each formulation can be found in 2.4.2.3.2.3. The temperature should be checked regularly.   | 3238   |
| –      | T23                                | –             | F-F, S-K               | Category D<br>SW1<br>SW3 | SG35<br>SG36        | Decomposes at temperatures higher than the emergency temperature or in a fire. Burns vigorously. Immiscible with water. Contact with alkalis or acids may cause dangerous decomposition. The products of combustion or self-accelerating decomposition may be toxic by inhalation. Control and emergency temperatures for each formulation can be found in 2.4.2.3.2.3. The temperature must be checked regularly.  | 3239   |

Part 3 – Dangerous Goods List, special provisions and exceptions

Chapter 3.2 – Dangerous Goods List

| UN No. | Proper shipping name (PSN)  | Class or division | Subsidiary hazard(s) | Packing group  | Special provisions | Limited and excepted quantity provisions |                     | Packing      |              | IBC           |               |
|--------|---|-------------------|----------------------|----------------|--------------------|--|---------------------|--------------|--------------|---------------|---------------|
|        |   |                   |                      |                |                    | Limited quantities                       | Excepted quantities | Instructions | Provisions   | Instructions  | Provisions    |
| (1)    | (2)<br>3.1.2  | (3)<br>2.0        | (4)<br>2.0           | (5)<br>2.0.1.3 | (6)<br>3.3         | (7a)<br>3.4                              | (7b)<br>3.5         | (8)<br>4.1.4 | (9)<br>4.1.4 | (10)<br>4.1.4 | (11)<br>4.1.4 |
| 3240   | SELF-REACTIVE SOLID TYPE F, TEMPERATURE CONTROLLED                    | 4.1               | –                    | –              | 194<br>274<br>923  | 0  | E0                  | P520         | –            | –             | –             |
| 3241   | 2-BROMO-2-NITROPROPANE-1,3-DIOL                                       | 4.1               | –                    | III            | –                  | 5 kg                                     | E1                  | P520         | PP22         | IBC08         | B3            |
| 3242   | AZODICARBONAMIDE  | 4.1               | –                    | II             | 215                | 500 g                                    | E0                  | P409         | –            | –             | –             |
| 3243   | SOLIDS CONTAINING TOXIC LIQUID, N.O.S.                                | 6.1               | –                    | II             | 217<br>274         | 500 g                                    | E4                  | P002         | PP9          | IBC02         | –             |
| 3244   | SOLIDS CONTAINING CORROSIVE LIQUID, N.O.S.                            | 8                 | –                    | II             | 218<br>274         | 1 kg                                     | E2                  | P002         | PP9          | IBC05         | –             |
| 3245   | GENETICALLY MODIFIED MICROORGANISMS or GENETICALLY MODIFIED ORGANISMS | 9                 | –                    | –              | 219                | 0  | E0                  | P904         | –            | IBC99         | –             |
| 3246   | METHANESULPHONYL CHLORIDE   | 6.1               | 8                    | I              | 354                | 0  | E0                  | P602         | –            | –             | –             |
| 3247   | SODIUM PEROXOBORATE, ANHYDROUS  | 5.1               | –                    | II             | –                  | 1 kg                                     | E2                  | P002         | –            | IBC08         | B4<br>B21     |
| 3248   | MEDICINE, LIQUID, FLAMMABLE, TOXIC, N.O.S.                            | 3                 | 6.1                  | II             | 220<br>221         | 1 L                                      | E2                  | P001         | –            | –             | –             |
| 3248   | MEDICINE, LIQUID, FLAMMABLE, TOXIC, N.O.S.                            | 3                 | 6.1                  | III            | 220<br>221<br>223  | 5 L                                      | E1                  | P001         | –            | –             | –             |
| 3249   | MEDICINE, SOLID, TOXIC, N.O.S.  | 6.1               | –                    | II             | 221                | 500 g                                    | E4                  | P002         | –            | –             | –             |
| 3249   | MEDICINE, SOLID, TOXIC, N.O.S.  | 6.1               | –                    | III            | 221<br>223         | 5 kg                                     | E1                  | P002<br>LP02 | –            | –             | –             |
| 3250   | CHLOROACETIC ACID, MOLTEN   | 6.1               | 8                    | II             | –                  | 0  | E0                  | –            | –            | –             | –             |
| 3251   | ISOSORBIDE-5-MONONITRATE  | 4.1               | –                    | III            | 226                | 5 kg                                     | E0                  | P409         | –            | –             | –             |
| 3252   | DIFLUOROMETHANE (REFRIGERANT GAS R 32)                                | 2.1               | –                    | –              | –                  | 0  | E0                  | P200         | –            | –             | –             |
| 3253   | DISODIUM TRIOXOSILICATE   | 8                 | –                    | III            | –                  | 5 kg                                     | E1                  | P002<br>LP02 | –            | IBC08         | B3            |

| UN No. | Portable tanks and bulk containers |               | EmS                    | Stowage and handling                 | Segregation          | Properties and observations   | UN No. |
|--------|------------------------------------|---------------|------------------------|--------------------------------------|----------------------|---|--------|
|        | Tank instructions                  | Provisions    |                        |                                      |                      |   |        |
| (12)   | (13)<br>4.2.5<br>4.3               | (14)<br>4.2.5 | (15)<br>5.4.3.4<br>7.8 | (16a)<br>7.1<br>7.3–7.7              | (16b)<br>7.2–7.7     | (17)  | (18)   |
| –      | T23                                | –             | F-F, S-K               | Category D<br>SW1<br>SW3             | SG35<br>SG36         | Decomposes at temperatures higher than the emergency temperature or in a fire. Burns vigorously. Insoluble in water. Contact with alkalis or acids may cause dangerous decomposition. The products of combustion or self-accelerating decomposition may be toxic by inhalation. Control and emergency temperatures for each formulation can be found in 2.4.2.3.2.3. The temperature must be checked regularly. | 3240   |
| –      | –                                  | –             | F-J, S-G               | Category C<br>SW1<br>SW2<br>H2<br>H3 | –                    | White crystals. Soluble in water. Decomposes when heated, evolving toxic gases. Sensitive to strong detonation shock. This substance shall be packed in accordance with packing method OP6 (see applicable packing instruction).  | 3241   |
| –      | T3                                 | TP33          | F-J, S-G               | Category D                           | SG17<br>SG35<br>SG36 | Yellow or orange powder. Insoluble in water. Heat may cause exothermic decomposition, producing carbon monoxide (a toxic and flammable gas) and nitrogen. May explode if involved in a fire under confined conditions. Addition of activators (e.g. zinc compounds) may result in a decrease of thermal stability and/or a change in explosive properties.  | 3242   |
| –      | T3<br>BK2                          | TP33          | F-A, S-A               | Category B<br>SW2                    | –                    | Mixtures of non-dangerous solids (such as soil, sand, production materials, etc.) and toxic liquids. Toxic if swallowed, by skin contact or by inhalation.  | 3243   |
| –      | T3<br>BK2                          | TP33          | F-A, S-B               | Category B<br>SW2                    | –                    | Mixtures of non-dangerous solids (such as soil, sand, production materials, etc.) and corrosive liquids. Cause burns to skin, eyes and mucous membranes.  | 3244   |
| –      | –                                  | –             | F-A, S-T               | SW7                                  | SG50                 | –   | 3245   |
| –      | T20                                | TP2<br>TP13   | F-A, S-B               | Category D<br>SW2                    | SGG1<br>SG36<br>SG49 | Pale yellow liquid. Highly toxic if swallowed, by skin contact or by inhalation. Causes burns to skin, eyes and mucous membranes.   | 3246   |
| –      | T3                                 | TP33          | F-A, S-Q               | Category A<br>SW1<br>H1              | –                    | Yellowish, odourless crystals. Soluble in water. Mixtures with combustible material are readily ignited and may burn fiercely. Harmful if swallowed.  | 3247   |
| –      | –                                  | –             | F-E, S-D               | Category B<br>SW2                    | –                    | Toxic if swallowed, by skin contact or by inhalation.   | 3248   |
| –      | –                                  | –             | F-E, S-D               | Category A                           | –                    | See entry above.  | 3248   |
| –      | T3                                 | TP33          | F-A, S-A               | Category C<br>SW2                    | –                    | Toxic if swallowed, by skin contact or by dust inhalation.  | 3249   |
| –      | T1                                 | TP33          | F-A, S-A               | Category C<br>SW2                    | –                    | See entry above.  | 3249   |
| –      | T7                                 | TP3<br>TP28   | F-A, S-B               | Category C<br>SW2                    | SGG1<br>SG36<br>SG49 | Molten liquid. Melting point may be as low as 50°C. Toxic if swallowed, by skin contact or by inhalation. Causes burns to skin, eyes and mucous membranes.  | 3250   |
| –      | –                                  | –             | F-F, S-G               | Category D<br>SW1<br>SW2<br>H2<br>H3 | –                    | May explode if involved in a fire under confined conditions. Sensitive to strong detonation shock.  | 3251   |
| –      | T50                                | –             | F-D, S-U               | Category D<br>SW2                    | –                    | Flammable colourless gas. Heavier than air (1.8).   | 3252   |
| –      | T1                                 | TP33          | F-A, S-B               | Category A                           | SGG18<br>SG35        | Colourless hygroscopic solid. Dangerous reaction with oxidizers. In the presence of moisture, reacts with aluminium, zinc, tin and their compounds, evolving hydrogen, a flammable gas. Causes burns to skin, eyes and mucous membranes. Reacts violently with acids.   | 3253   |



| UN No. | Proper shipping name (PSN)   | Class or division | Subsidiary hazard(s) | Packing group  | Special provisions | Limited and excepted quantity provisions |                     | Packing      |              | IBC           |               |
|--------|--|-------------------|----------------------|----------------|--------------------|--|---------------------|--------------|--------------|---------------|---------------|
|        |  |                   |                      |                |                    | Limited quantities                       | Excepted quantities | Instructions | Provisions   | Instructions  | Provisions    |
| (1)    | (2)<br>3.1.2   | (3)<br>2.0        | (4)<br>2.0           | (5)<br>2.0.1.3 | (6)<br>3.3         | (7a)<br>3.4                              | (7b)<br>3.5         | (8)<br>4.1.4 | (9)<br>4.1.4 | (10)<br>4.1.4 | (11)<br>4.1.4 |
| 3254   | TRIBUTYLPHOSPHANE  | 4.2               | –                    | I              | –                  | 0  | E0                  | P400         | –            | –             | –             |
| 3255   | tert-BUTYL HYPOCHLORITE  | 4.2               | 8                    | I              | 976                | 0  | E0                  | P099         | –            | –             | –             |
| 3256   | ELEVATED TEMPERATURE LIQUID, FLAMMABLE, N.O.S. with flashpoint above 60°C, at or above its flashpoint                        | 3                 | –                    | III            | 274                | 0  | E0                  | P099         | –            | IBC01         | –             |
| 3257   | ELEVATED TEMPERATURE LIQUID, N.O.S. at or above 100°C and below its flashpoint (including molten metals, molten salts, etc.) | 9                 | –                    | III            | 232<br>274         | 0  | E0                  | P099         | –            | IBC01         | –             |
| 3258   | ELEVATED TEMPERATURE SOLID, N.O.S. at or above 240°C   | 9                 | –                    | III            | 232<br>274         | 0  | E0                  | P099         | –            | –             | –             |
| 3259   | AMINES, SOLID, CORROSIVE, N.O.S. or POLYAMINES, SOLID, CORROSIVE, N.O.S.   | 8                 | –                    | I              | 274                | 0  | E0                  | P002         | –            | IBC07         | B1            |
| 3259   | AMINES, SOLID, CORROSIVE, N.O.S. or POLYAMINES, SOLID, CORROSIVE, N.O.S.   | 8                 | –                    | II             | 274                | 1 kg                                     | E2                  | P002         | –            | IBC08         | B4<br>B21     |
| 3259   | AMINES, SOLID, CORROSIVE, N.O.S. or POLYAMINES, SOLID, CORROSIVE, N.O.S.   | 8                 | –                    | III            | 223<br>274         | 5 kg                                     | E1                  | P002<br>LP02 | –            | IBC08         | B3            |
| 3260   | CORROSIVE SOLID, ACIDIC, INORGANIC, N.O.S.   | 8                 | –                    | I              | 274                | 0  | E0                  | P002         | –            | IBC07         | B1            |
| 3260   | CORROSIVE SOLID, ACIDIC, INORGANIC, N.O.S.   | 8                 | –                    | II             | 274                | 1 kg                                     | E2                  | P002         | –            | IBC08         | B4<br>B21     |
| 3260   | CORROSIVE SOLID, ACIDIC, INORGANIC, N.O.S.   | 8                 | –                    | III            | 223<br>274         | 5 kg                                     | E1                  | P002<br>LP02 | –            | IBC08         | B3            |
| 3261   | CORROSIVE SOLID, ACIDIC, ORGANIC, N.O.S.   | 8                 | –                    | I              | 274                | 0  | E0                  | P002         | –            | IBC07         | B1            |
| 3261   | CORROSIVE SOLID, ACIDIC, ORGANIC, N.O.S.   | 8                 | –                    | II             | 274                | 1 kg                                     | E2                  | P002         | –            | IBC08         | B4<br>B21     |
| 3261   | CORROSIVE SOLID, ACIDIC, ORGANIC, N.O.S.   | 8                 | –                    | III            | 223<br>274         | 5 kg                                     | E1                  | P002<br>LP02 | –            | IBC08         | B3            |
| 3262   | CORROSIVE SOLID, BASIC, INORGANIC, N.O.S.  | 8                 | –                    | I              | 274                | 0  | E0                  | P002         | –            | IBC07         | B1            |
| 3262   | CORROSIVE SOLID, BASIC, INORGANIC, N.O.S.  | 8                 | –                    | II             | 274                | 1 kg                                     | E2                  | P002         | –            | IBC08         | B4<br>B21     |
| 3262   | CORROSIVE SOLID, BASIC, INORGANIC, N.O.S.  | 8                 | –                    | III            | 223<br>274         | 5 kg                                     | E1                  | P002<br>LP02 | –            | IBC08         | B3            |

| UN No. | Portable tanks and bulk containers |               | EmS                    | Stowage and handling    | Segregation          | Properties and observations   | UN No. |
|--------|------------------------------------|---------------|------------------------|-------------------------|----------------------|---|--------|
|        | Tank instructions                  | Provisions    |                        |                         |                      |   |        |
| (12)   | (13)<br>4.2.5<br>4.3               | (14)<br>4.2.5 | (15)<br>5.4.3.4<br>7.8 | (16a)<br>7.1<br>7.3–7.7 | (16b)<br>7.2–7.7     | (17)  | (18)   |
| –      | T21                                | TP2<br>TP7    | F-A, S-M               | Category D              | SG44                 | Colourless yellowish liquid. Insoluble in water. Strong garlic odour (phosphine). Liable to heat and ignite spontaneously in air. If involved in a fire, evolves phosphine, a flammable and highly toxic gas. Reacts violently with oxidizing substances (peroxides, halogens, nitric oxides and carbon tetrachloride). Irritating to mucous membranes. | 3254   |
| –      | –                                  | –             | F-A, S-M               | Category D              | SGG8                 | Volatile flammable slightly yellow liquid with a pungent odour. Immiscible with water. Boiling point: 77°C to 79°C. Flashpoint between –15°C and –10°C. Exposure to light causes immediate dangerous decomposition. Causes burns to skin, eyes and mucous membranes.  | 3255   |
| –      | T3                                 | TP3<br>TP29   | F-E, S-D               | Category A              | –                    | –   | 3256   |
| –      | T3                                 | TP3<br>TP29   | F-A, S-P               | Category A<br>SW5       | –                    | Any liquid which is transported at or above 100°C but below its flashpoint. May cause fire if in contact with combustible material due to extreme temperature.  | 3257   |
| –      | –                                  | –             | F-A, S-P               | Category A<br>SW5       | –                    | Any solid which is transported at or above 240°C. May cause fire if in contact with combustible material due to extreme temperature.  | 3258   |
| –      | T6                                 | TP33          | F-A, S-B               | Category A              | SGG18<br>SG35        | Colourless to yellowish solids with a pungent odour. Miscible with or soluble in water. When involved in a fire, evolve toxic gases. Corrosive to most metals, especially to copper and its alloys. Cause burns to skin, eyes and mucous membranes. React violently with acids.   | 3259   |
| –      | T3                                 | TP33          | F-A, S-B               | Category A              | SGG18<br>SG35        | See entry above.  | 3259   |
| –      | T1                                 | TP33          | F-A, S-B               | Category A              | SGG18<br>SG35        | See entry above.  | 3259   |
| –      | T6                                 | TP33          | F-A, S-B               | Category B              | SGG1<br>SG36<br>SG49 | Causes burns to skin, eyes and mucous membranes.  | 3260   |
| –      | T3                                 | TP33          | F-A, S-B               | Category B              | SGG1<br>SG36<br>SG49 | See entry above.  | 3260   |
| –      | T1                                 | TP33          | F-A, S-B               | Category A              | SGG1<br>SG36<br>SG49 | See entry above.  | 3260   |
| –      | T6                                 | TP33          | F-A, S-B               | Category B              | SGG1<br>SG36<br>SG49 | Causes burns to skin, eyes and mucous membranes.  | 3261   |
| –      | T3                                 | TP33          | F-A, S-B               | Category B              | SGG1<br>SG36<br>SG49 | See entry above.  | 3261   |
| –      | T1                                 | TP33          | F-A, S-B               | Category A              | SGG1<br>SG36<br>SG49 | See entry above.  | 3261   |
| –      | T6                                 | TP33          | F-A, S-B               | Category B              | SGG18<br>SG35        | Reacts violently with acids. Causes burns to skin, eyes and mucous membranes.   | 3262   |
| –      | T3                                 | TP33          | F-A, S-B               | Category B              | SGG18<br>SG35        | See entry above.  | 3262   |
| –      | T1                                 | TP33          | F-A, S-B               | Category A              | SGG18<br>SG35        | See entry above.  | 3262   |

Part 3 – Dangerous Goods List, special provisions and exceptions

Chapter 3.2 – Dangerous Goods List

| UN No. | Proper shipping name (PSN)   | Class or division | Subsidiary hazard(s) | Packing group  | Special provisions | Limited and excepted quantity provisions |                     | Packing       |              | IBC           |               |
|--------|--|-------------------|----------------------|----------------|--------------------|--|---------------------|---------------|--------------|---------------|---------------|
|        |  |                   |                      |                |                    | Limited quantities                       | Excepted quantities | Instructions  | Provisions   | Instructions  | Provisions    |
| (1)    | (2)<br>3.1.2   | (3)<br>2.0        | (4)<br>2.0           | (5)<br>2.0.1.3 | (6)<br>3.3         | (7a)<br>3.4                              | (7b)<br>3.5         | (8)<br>4.1.4  | (9)<br>4.1.4 | (10)<br>4.1.4 | (11)<br>4.1.4 |
| 3263   | CORROSIVE SOLID, BASIC, ORGANIC, N.O.S.  | 8                 | –                    | I              | 274                | 0  | E0                  | P002          | –            | IBC07         | B1            |
| 3263   | CORROSIVE SOLID, BASIC, ORGANIC, N.O.S.  | 8                 | –                    | II             | 274                | 1 kg                                     | E2                  | P002          | –            | IBC08         | B4<br>B21     |
| 3263   | CORROSIVE SOLID, BASIC, ORGANIC, N.O.S.  | 8                 | –                    | III            | 223<br>274         | 5 kg                                     | E1                  | P002<br>LP02  | –            | IBC08         | B3            |
| 3264   | CORROSIVE LIQUID, ACIDIC, INORGANIC, N.O.S.                                    | 8                 | –                    | I              | 274                | 0  | E0                  | P001          | –            | –             | –             |
| 3264   | CORROSIVE LIQUID, ACIDIC, INORGANIC, N.O.S.                                    | 8                 | –                    | II             | 274                | 1 L                                      | E2                  | P001          | –            | IBC02         | –             |
| 3264   | CORROSIVE LIQUID, ACIDIC, INORGANIC, N.O.S.                                    | 8                 | –                    | III            | 223<br>274         | 5 L                                      | E1                  | P001<br>LP01  | –            | IBC03         | –             |
| 3265   | CORROSIVE LIQUID, ACIDIC, ORGANIC, N.O.S.                                      | 8                 | –                    | I              | 274                | 0  | E0                  | P001          | –            | –             | –             |
| 3265   | CORROSIVE LIQUID, ACIDIC, ORGANIC, N.O.S.                                      | 8                 | –                    | II             | 274                | 1 L                                      | E2                  | P001          | –            | IBC02         | –             |
| 3265   | CORROSIVE LIQUID, ACIDIC, ORGANIC, N.O.S.                                      | 8                 | –                    | III            | 223<br>274         | 5 L                                      | E1                  | P001<br>LP01  | –            | IBC03         | –             |
| 3266   | CORROSIVE LIQUID, BASIC, INORGANIC, N.O.S.                                     | 8                 | –                    | I              | 274                | 0  | E0                  | P001          | –            | –             | –             |
| 3266   | CORROSIVE LIQUID, BASIC, INORGANIC, N.O.S.                                     | 8                 | –                    | II             | 274                | 1 L                                      | E2                  | P001          | –            | IBC02         | –             |
| 3266   | CORROSIVE LIQUID, BASIC, INORGANIC, N.O.S.                                     | 8                 | –                    | III            | 223<br>274         | 5 L                                      | E1                  | P001<br>LP01  | –            | IBC03         | –             |
| 3267   | CORROSIVE LIQUID, BASIC, ORGANIC, N.O.S.                                       | 8                 | –                    | I              | 274                | 0  | E0                  | P001          | –            | –             | –             |
| 3267   | CORROSIVE LIQUID, BASIC, ORGANIC, N.O.S.                                       | 8                 | –                    | II             | 274                | 1 L                                      | E2                  | P001          | –            | IBC02         | –             |
| 3267   | CORROSIVE LIQUID, BASIC, ORGANIC, N.O.S.                                       | 8                 | –                    | III            | 223<br>274         | 5 L                                      | E1                  | P001<br>LP01  | –            | IBC03         | –             |
| 3268   | SAFETY DEVICES, electrically initiated   | 9                 | –                    | –              | 280<br>289         | 0  | E0                  | P902<br>LP902 | –            | –             | –             |
| 3269   | POLYESTER RESIN KIT, liquid base material                                      | 3                 | –                    | II             | 236<br>340         | 5 L                                      | See SP340           | P302          | –            | –             | –             |
| 3269   | POLYESTER RESIN KIT, liquid base material                                      | 3                 | –                    | III            | 236<br>340         | 5 L                                      | See SP340           | P302          | –            | –             | –             |
| △ 3270 | NITROCELLULOSE MEMBRANE FILTERS with not more than 12.6% nitrogen, by dry mass | 4.1               | –                    | II             | 237<br>286<br>403  | 1 kg                                     | E2                  | P411          | –            | –             | –             |
| 3271   | ETHERS, N.O.S.   | 3                 | –                    | II             | 274                | 1 L                                      | E2                  | P001          | –            | IBC02         | –             |
| 3271   | ETHERS, N.O.S.   | 3                 | –                    | III            | 223<br>274         | 5 L                                      | E1                  | P001<br>LP01  | –            | IBC03         | –             |
| 3272   | ESTERS, N.O.S.   | 3                 | –                    | II             | 274                | 1 L                                      | E2                  | P001          | –            | IBC02         | –             |

| UN No. | Portable tanks and bulk containers |                    | EmS                    | Stowage and handling    | Segregation          | Properties and observations   | UN No. |
|--------|------------------------------------|--------------------|------------------------|-------------------------|----------------------|---|--------|
|        | Tank instructions                  | Provisions         |                        |                         |                      |   |        |
| (12)   | (13)<br>4.2.5<br>4.3               | (14)<br>4.2.5      | (15)<br>5.4.3.4<br>7.8 | (16a)<br>7.1<br>7.3–7.7 | (16b)<br>7.2–7.7     | (17)  | (18)   |
| –      | T6                                 | TP33               | F-A, S-B               | Category B              | SGG18<br>SG35        | Reacts violently with acids. Causes burns to skin, eyes and mucous membranes.   | 3263   |
| –      | T3                                 | TP33               | F-A, S-B               | Category B              | SGG18<br>SG35        | See entry above.  | 3263   |
| –      | T1                                 | TP33               | F-A, S-B               | Category A              | SGG18<br>SG35        | See entry above.  | 3263   |
| –      | T14                                | TP2<br>TP27        | F-A, S-B               | Category B<br>SW2       | SGG1<br>SG36<br>SG49 | Causes burns to skin, eyes and mucous membranes.  | 3264   |
| –      | T11                                | TP2<br>TP27        | F-A, S-B               | Category B<br>SW2       | SGG1<br>SG36<br>SG49 | See entry above.  | 3264   |
| –      | T7                                 | TP1<br>TP28        | F-A, S-B               | Category A<br>SW2       | SGG1<br>SG36<br>SG49 | See entry above.  | 3264   |
| –      | T14                                | TP2<br>TP27        | F-A, S-B               | Category B<br>SW2       | SGG1<br>SG36<br>SG49 | Causes burns to skin, eyes and mucous membranes.  | 3265   |
| –      | T11                                | TP2<br>TP27        | F-A, S-B               | Category B<br>SW2       | SGG1<br>SG36<br>SG49 | See entry above.  | 3265   |
| –      | T7                                 | TP1<br>TP28        | F-A, S-B               | Category A<br>SW2       | SGG1<br>SG36<br>SG49 | See entry above.  | 3265   |
| –      | T14                                | TP2<br>TP27        | F-A, S-B               | Category B<br>SW2       | SGG18<br>SG35        | Reacts violently with acids. Causes burns to skin, eyes and mucous membranes.   | 3266   |
| –      | T11                                | TP2<br>TP27        | F-A, S-B               | Category B<br>SW2       | SGG18<br>SG35        | See entry above.  | 3266   |
| –      | T7                                 | TP1<br>TP28        | F-A, S-B               | Category A<br>SW2       | SGG18<br>SG35        | See entry above.  | 3266   |
| –      | T14                                | TP2<br>TP27        | F-A, S-B               | Category B<br>SW2       | SGG18<br>SG35        | Reacts violently with acids. Causes burns to skin, eyes and mucous membranes.   | 3267   |
| –      | T11                                | TP2<br>TP27        | F-A, S-B               | Category B<br>SW2       | SGG18<br>SG35        | See entry above.  | 3267   |
| –      | T7                                 | TP1<br>TP28        | F-A, S-B               | Category A<br>SW2       | SGG18<br>SG35        | See entry above.  | 3267   |
| –      | –                                  | –                  | F-B, S-X               | Category A              | –                    | –   | 3268   |
| –      | –                                  | –                  | F-E, S-D               | Category B              | –                    | Polyester resin kits consist of two components: a base material (flammable liquid) and an activator (organic peroxide), each separately packed in an inner packaging.   | 3269   |
| –      | –                                  | –                  | F-E, S-D               | Category A              | –                    | See entry above.  | 3269   |
| –      | –                                  | –                  | F-A, S-I               | Category D              | –                    | Filters may be small round pieces or large sheets. When involved in a fire, evolve toxic fumes; in closed compartments, these fumes may form an explosive mixture with air. Burn rapidly with intense heat radiation. | △ 3270 |
| –      | T7                                 | TP1<br>TP8<br>TP28 | F-E, S-D               | Category B              | –                    | –   | 3271   |
| –      | T4                                 | TP1<br>TP29        | F-E, S-D               | Category A              | –                    | –   | 3271   |
| –      | T7                                 | TP1<br>TP8<br>TP28 | F-E, S-D               | Category B              | –                    | –   | 3272   |

Part 3 – Dangerous Goods List, special provisions and exceptions

Chapter 3.2 – Dangerous Goods List

| UN No. | Proper shipping name (PSN)                          | Class or division | Subsidiary hazard(s) | Packing group  | Special provisions | Limited and excepted quantity provisions |                     | Packing      |              | IBC           |               |
|--------|---|-------------------|----------------------|----------------|--------------------|--|---------------------|--------------|--------------|---------------|---------------|
|        |   |                   |                      |                |                    | Limited quantities                       | Excepted quantities | Instructions | Provisions   | Instructions  | Provisions    |
| (1)    | (2)<br>3.1.2  | (3)<br>2.0        | (4)<br>2.0           | (5)<br>2.0.1.3 | (6)<br>3.3         | (7a)<br>3.4                              | (7b)<br>3.5         | (8)<br>4.1.4 | (9)<br>4.1.4 | (10)<br>4.1.4 | (11)<br>4.1.4 |
| 3272   | ESTERS, N.O.S.                                      | 3                 | –                    | III            | 223<br>274         | 5 L                                      | E1                  | P001<br>LP01 | –            | IBC03         | –             |
| 3273   | NITRILES, FLAMMABLE, TOXIC, N.O.S.                  | 3                 | 6.1                  | I              | 274                | 0  | E0                  | P001         | –            | –             | –             |
| 3273   | NITRILES, FLAMMABLE, TOXIC, N.O.S.                  | 3                 | 6.1                  | II             | 274                | 1 L                                      | E2                  | P001         | –            | IBC02         | –             |
| 3274   | ALCOHOLATES SOLUTION, N.O.S. in alcohol             | 3                 | 8                    | II             | 274                | 1 L                                      | E2                  | P001         | –            | IBC02         | –             |
| 3275   | NITRILES, TOXIC, FLAMMABLE, N.O.S.                  | 6.1               | 3                    | I              | 274<br>315         | 0  | E5                  | P001         | –            | –             | –             |
| 3275   | NITRILES, TOXIC, FLAMMABLE, N.O.S.                  | 6.1               | 3                    | II             | 274                | 100 mL                                   | E4                  | P001         | –            | IBC02         | –             |
| 3276   | NITRILES, LIQUID, TOXIC, N.O.S.                     | 6.1               | –                    | I              | 274<br>315         | 0  | E5                  | P001         | –            | –             | –             |
| 3276   | NITRILES, LIQUID, TOXIC, N.O.S.                     | 6.1               | –                    | II             | 274                | 100 mL                                   | E4                  | P001         | –            | IBC02         | –             |
| 3276   | NITRILES, LIQUID, TOXIC, N.O.S.                     | 6.1               | –                    | III            | 223<br>274         | 5 L                                      | E1                  | P001<br>LP01 | –            | IBC03         | –             |
| 3277   | CHLOROFORMATES, TOXIC, CORROSIVE, N.O.S.            | 6.1               | 8                    | II             | 274                | 100 mL                                   | E4                  | P001         | –            | IBC02         | –             |
| 3278   | ORGANOPHOSPHORUS COMPOUND, LIQUID, TOXIC, N.O.S.    | 6.1               | –                    | I              | 43<br>274<br>315   | 0  | E5                  | P001         | –            | –             | –             |
| 3278   | ORGANOPHOSPHORUS COMPOUND, LIQUID, TOXIC, N.O.S.    | 6.1               | –                    | II             | 43<br>274          | 100 mL                                   | E4                  | P001         | –            | IBC02         | –             |
| 3278   | ORGANOPHOSPHORUS COMPOUND, LIQUID, TOXIC, N.O.S.    | 6.1               | –                    | III            | 43<br>223<br>274   | 5 L                                      | E1                  | P001<br>LP01 | –            | IBC03         | –             |
| 3279   | ORGANOPHOSPHORUS COMPOUND, TOXIC, FLAMMABLE, N.O.S. | 6.1               | 3                    | I              | 43<br>274<br>315   | 0  | E5                  | P001         | –            | –             | –             |
| 3279   | ORGANOPHOSPHORUS COMPOUND, TOXIC, FLAMMABLE, N.O.S. | 6.1               | 3                    | II             | 43<br>274          | 100 mL                                   | E4                  | P001         | –            | –             | –             |
| 3280   | ORGANOARSENIC COMPOUND, LIQUID, N.O.S.              | 6.1               | –                    | I              | 274<br>315         | 0  | E5                  | P001         | –            | –             | –             |
| 3280   | ORGANOARSENIC COMPOUND, LIQUID, N.O.S.              | 6.1               | –                    | II             | 274                | 100 mL                                   | E4                  | P001         | –            | IBC02         | –             |
| 3280   | ORGANOARSENIC COMPOUND, LIQUID, N.O.S.              | 6.1               | –                    | III            | 223<br>274         | 5 L                                      | E1                  | P001<br>LP01 | –            | IBC03         | –             |
| 3281   | METAL CARBONYLS, LIQUID, N.O.S.                     | 6.1               | –                    | I              | 274<br>315         | 0  | E5                  | P601         | –            | –             | –             |

| UN No. | Portable tanks and bulk containers |                     | EmS                    | Stowage and handling                 | Segregation          | Properties and observations  | UN No. |
|--------|------------------------------------|---------------------|------------------------|--------------------------------------|----------------------|--|--------|
|        | Tank instructions                  | Provisions          |                        |                                      |                      |  |        |
| (12)   | (13)<br>4.2.5<br>4.3               | (14)<br>4.2.5       | (15)<br>5.4.3.4<br>7.8 | (16a)<br>7.1<br>7.3–7.7              | (16b)<br>7.2–7.7     | (17)   | (18)   |
| –      | T4                                 | TP1<br>TP29         | F-E, S-D               | Category A                           | –                    | –  | 3272   |
| –      | T14                                | TP2<br>TP13<br>TP27 | F-E, S-D               | Category E<br>SW2                    | SG35                 | Liquids evolving toxic vapour. React with acids or acid fumes, evolving hydrogen cyanide, a highly toxic and flammable gas. Toxic if swallowed, by skin contact or by inhalation.  | 3273   |
| –      | T11                                | TP2<br>TP13<br>TP27 | F-E, S-D               | Category B<br>SW2                    | SG35                 | See entry above.   | 3273   |
| –      | –                                  | –                   | F-E, S-C               | Category B                           | SGG18<br>SG35        | Colourless solution. Reacts violently with water. Causes burns to skin, eyes and mucous membranes.   | 3274   |
| –      | T14                                | TP2<br>TP13<br>TP27 | F-E, S-D               | Category B<br>SW2                    | SG35                 | Flammable liquids, evolving toxic vapour. React with acids or acid fumes, evolving hydrogen cyanide, a highly toxic and flammable gas. Miscible with water. Toxic if swallowed, by skin contact or by inhalation.                  | 3275   |
| –      | T11                                | TP2<br>TP13<br>TP27 | F-E, S-D               | Category B<br>SW2                    | SG35                 | See entry above.   | 3275   |
| –      | T14                                | TP2<br>TP13<br>TP27 | F-A, S-A               | Category B                           | SG35                 | Liquids, evolving toxic vapour. React with acids or acid fumes, evolving hydrogen cyanide, a highly toxic and flammable gas. Miscible with water. Toxic if swallowed, by skin contact or by inhalation.                            | 3276   |
| –      | T11                                | TP2<br>TP27         | F-A, S-A               | Category B                           | SG35                 | See entry above.   | 3276   |
| –      | T7                                 | TP1<br>TP28         | F-A, S-A               | Category A                           | SG35                 | See entry above.   | 3276   |
| –      | T8                                 | TP2<br>TP13<br>TP28 | F-A, S-B               | Category A<br>SW1<br>SW2<br>H1<br>H2 | SGG1<br>SG36<br>SG49 | React and decompose with water or heat, evolving hydrogen chloride, an irritating and corrosive gas apparent as white fumes. Toxic if swallowed, by skin contact or by inhalation. Cause burns to skin, eyes and mucous membranes. | 3277   |
| –      | T14                                | TP2<br>TP13<br>TP27 | F-A, S-A               | Category B                           | –                    | Toxic if swallowed, by skin contact or by inhalation.  | 3278   |
| –      | T11                                | TP2<br>TP27         | F-A, S-A               | Category B                           | –                    | See entry above.   | 3278   |
| –      | T7                                 | TP1<br>TP28         | F-A, S-A               | Category A                           | –                    | See entry above.   | 3278   |
| –      | T14                                | TP2<br>TP13<br>TP27 | F-E, S-D               | Category B<br>SW2                    | –                    | A wide variety of toxic flammable liquids. Toxic if swallowed, by skin contact or by inhalation.   | 3279   |
| –      | T11                                | TP2<br>TP13<br>TP27 | F-E, S-D               | Category B<br>SW2                    | –                    | See entry above.   | 3279   |
| –      | T14                                | TP2<br>TP13<br>TP27 | F-A, S-A               | Category B                           | –                    | Toxic if swallowed, by skin contact or by inhalation.  | 3280   |
| –      | T11                                | TP2<br>TP27         | F-A, S-A               | Category B                           | –                    | See entry above.   | 3280   |
| –      | T7                                 | TP1<br>TP28         | F-A, S-A               | Category A                           | –                    | See entry above.   | 3280   |
| –      | T14                                | TP2<br>TP13<br>TP27 | F-A, S-A               | Category D<br>SW2                    | –                    | A range of metal carbonyls which, when heated, can give off carbon monoxide, a toxic gas. Immiscible with water. Toxic if swallowed, by skin contact or by inhalation.   | 3281   |

Part 3 – Dangerous Goods List, special provisions and exceptions

Chapter 3.2 – Dangerous Goods List

| UN No. | Proper shipping name (PSN)                     | Class or division | Subsidiary hazard(s) | Packing group  | Special provisions | Limited and excepted quantity provisions |                     | Packing      |              | IBC           |               |
|--------|--|-------------------|----------------------|----------------|--------------------|--|---------------------|--------------|--------------|---------------|---------------|
|        |  |                   |                      |                |                    | Limited quantities                       | Excepted quantities | Instructions | Provisions   | Instructions  | Provisions    |
| (1)    | (2)<br>3.1.2                                   | (3)<br>2.0        | (4)<br>2.0           | (5)<br>2.0.1.3 | (6)<br>3.3         | (7a)<br>3.4                              | (7b)<br>3.5         | (8)<br>4.1.4 | (9)<br>4.1.4 | (10)<br>4.1.4 | (11)<br>4.1.4 |
| 3281   | METAL CARBONYLS, LIQUID, N.O.S.                | 6.1               | –                    | II             | 274                | 100 mL                                   | E4                  | P001         | –            | IBC02         | –             |
| 3281   | METAL CARBONYLS, LIQUID, N.O.S.                | 6.1               | –                    | III            | 223<br>274         | 5 L                                      | E1                  | P001<br>LP01 | –            | IBC03         | –             |
| 3282   | ORGANOMETALLIC COMPOUND, LIQUID, TOXIC, N.O.S. | 6.1               | –                    | I              | 274                | 0  | E5                  | P001         | –            | –             | –             |
| 3282   | ORGANOMETALLIC COMPOUND, LIQUID, TOXIC, N.O.S. | 6.1               | –                    | II             | 274                | 100 mL                                   | E4                  | P001         | –            | IBC02         | –             |
| 3282   | ORGANOMETALLIC COMPOUND, LIQUID, TOXIC, N.O.S. | 6.1               | –                    | III            | 223<br>274         | 5 L                                      | E1                  | P001<br>LP01 | –            | IBC03         | –             |
| 3283   | SELENIUM COMPOUND, SOLID, N.O.S.               | 6.1               | –                    | I              | 274                | 0  | E5                  | P002         | –            | IBC07         | B1            |
| 3283   | SELENIUM COMPOUND, SOLID, N.O.S.               | 6.1               | –                    | II             | 274                | 500 g                                    | E4                  | P002         | –            | IBC08         | B4<br>B21     |
| 3283   | SELENIUM COMPOUND, SOLID, N.O.S.               | 6.1               | –                    | III            | 223<br>274         | 5 kg                                     | E1                  | P002<br>LP02 | –            | IBC08         | B3            |
| 3284   | TELLURIUM COMPOUND, N.O.S.                     | 6.1               | –                    | I              | 274                | 0  | E5                  | P002         | –            | IBC07         | B1            |
| 3284   | TELLURIUM COMPOUND, N.O.S.                     | 6.1               | –                    | II             | 274                | 500 g                                    | E4                  | P002         | –            | IBC08         | B4<br>B21     |
| 3284   | TELLURIUM COMPOUND, N.O.S.                     | 6.1               | –                    | III            | 223<br>274         | 5 kg                                     | E1                  | P002<br>LP02 | –            | IBC08         | B3            |
| 3285   | VANADIUM COMPOUND, N.O.S.                      | 6.1               | –                    | I              | 274                | 0  | E5                  | P002         | –            | IBC07         | B1            |
| 3285   | VANADIUM COMPOUND, N.O.S.                      | 6.1               | –                    | II             | 274                | 500 g                                    | E4                  | P002         | –            | IBC08         | B4<br>B21     |
| 3285   | VANADIUM COMPOUND, N.O.S.                      | 6.1               | –                    | III            | 223<br>274         | 5 kg                                     | E1                  | P002<br>LP02 | –            | IBC08         | B3            |
| 3286   | FLAMMABLE LIQUID, TOXIC, CORROSIVE, N.O.S.     | 3                 | 6.1/8                | I              | 274                | 0  | E0                  | P001         | –            | –             | –             |
| 3286   | FLAMMABLE LIQUID, TOXIC, CORROSIVE, N.O.S.     | 3                 | 6.1/8                | II             | 274                | 1 L                                      | E2                  | P001         | –            | IBC99         | –             |
| 3287   | TOXIC LIQUID, INORGANIC, N.O.S.                | 6.1               | –                    | I              | 274<br>315         | 0  | E5                  | P001         | –            | –             | –             |
| 3287   | TOXIC LIQUID, INORGANIC, N.O.S.                | 6.1               | –                    | II             | 274                | 100 mL                                   | E4                  | P001         | –            | IBC02         | –             |
| 3287   | TOXIC LIQUID, INORGANIC, N.O.S.                | 6.1               | –                    | III            | 223<br>274         | 5 L                                      | E1                  | P001<br>LP01 | –            | IBC03         | –             |
| 3288   | TOXIC SOLID, INORGANIC, N.O.S.                 | 6.1               | –                    | I              | 274                | 0  | E5                  | P002         | –            | IBC99         | –             |
| 3288   | TOXIC SOLID, INORGANIC, N.O.S.                 | 6.1               | –                    | II             | 274                | 500 g                                    | E4                  | P002         | –            | IBC08         | B4<br>B21     |
| 3288   | TOXIC SOLID, INORGANIC, N.O.S.                 | 6.1               | –                    | III            | 223<br>274         | 5 kg                                     | E1                  | P002<br>LP02 | –            | IBC08         | B3            |
| 3289   | TOXIC LIQUID, CORROSIVE, INORGANIC, N.O.S.     | 6.1               | 8                    | I              | 274<br>315         | 0  | E5                  | P001         | –            | –             | –             |
| 3289   | TOXIC LIQUID, CORROSIVE, INORGANIC, N.O.S.     | 6.1               | 8                    | II             | 274                | 100 mL                                   | E4                  | P001         | –            | IBC02         | –             |

| UN No. | Portable tanks and bulk containers |                     | EmS                    | Stowage and handling    | Segregation      | Properties and observations  | UN No. |
|--------|------------------------------------|---------------------|------------------------|-------------------------|------------------|--|--------|
|        | Tank instructions                  | Provisions          |                        |                         |                  |  |        |
| (12)   | (13)<br>4.2.5<br>4.3               | (14)<br>4.2.5       | (15)<br>5.4.3.4<br>7.8 | (16a)<br>7.1<br>7.3–7.7 | (16b)<br>7.2–7.7 | (17)   | (18)   |
| –      | T11                                | TP2<br>TP27         | F-A, S-A               | Category B<br>SW2       | –                | A range of metal carbonyls which, when heated, can give off carbon monoxide, a toxic gas. Immiscible with water. Toxic if swallowed, by skin contact or by inhalation. | 3281   |
| –      | T7                                 | TP1<br>TP28         | F-A, S-A               | Category B<br>SW2       | –                | See entry above.   | 3281   |
| –      | T14                                | TP2<br>TP13<br>TP27 | F-A, S-A               | Category B              | –                | Toxic if swallowed, by skin contact or by inhalation.  | 3282   |
| –      | T11                                | TP2<br>TP27         | F-A, S-A               | Category B              | –                | See entry above.   | 3282   |
| –      | T7                                 | TP1<br>TP28         | F-A, S-A               | Category A              | –                | See entry above.   | 3282   |
| –      | T6                                 | TP33                | F-A, S-A               | Category B              | –                | Toxic if swallowed, by skin contact or by inhalation.  | 3283   |
| –      | T3                                 | TP33                | F-A, S-A               | Category B              | –                | See entry above.   | 3283   |
| –      | T1                                 | TP33                | F-A, S-A               | Category A              | –                | See entry above.   | 3283   |
| –      | T6                                 | TP33                | F-A, S-A               | Category B              | –                | Toxic if swallowed, by skin contact or by inhalation.  | 3284   |
| –      | T3                                 | TP33                | F-A, S-A               | Category B              | –                | See entry above.   | 3284   |
| –      | T1                                 | TP33                | F-A, S-A               | Category A              | –                | See entry above.   | 3284   |
| –      | T6                                 | TP33                | F-A, S-A               | Category B              | –                | Toxic if swallowed, by skin contact or by inhalation.  | 3285   |
| –      | T3                                 | TP33                | F-A, S-A               | Category B              | –                | See entry above.   | 3285   |
| –      | T1                                 | TP33                | F-A, S-A               | Category A              | –                | See entry above.   | 3285   |
| –      | T14                                | TP2<br>TP13<br>TP27 | F-E, S-C               | Category E<br>SW2       | SG5<br>SG8       | Flammable, toxic, corrosive liquid. Toxic if swallowed, by skin contact or by inhalation. Causes burns to skin, eyes and mucous membranes.                             | 3286   |
| –      | T11                                | TP2<br>TP13<br>TP27 | F-E, S-C               | Category B<br>SW2       | SG5<br>SG8       | See entry above.   | 3286   |
| –      | T14                                | TP2<br>TP13<br>TP27 | F-A, S-A               | Category B<br>SW2       | –                | Toxic if swallowed, by skin contact or by inhalation.  | 3287   |
| –      | T11                                | TP2<br>TP27         | F-A, S-A               | Category B<br>SW2       | –                | See entry above.   | 3287   |
| –      | T7                                 | TP1<br>TP28         | F-A, S-A               | Category A<br>SW2       | –                | See entry above.   | 3287   |
| –      | T6                                 | TP33                | F-A, S-A               | Category B              | –                | Toxic if swallowed, by skin contact or by inhalation.  | 3288   |
| –      | T3                                 | TP33                | F-A, S-A               | Category B              | –                | See entry above.   | 3288   |
| –      | T1                                 | TP33                | F-A, S-A               | Category A              | –                | See entry above.   | 3288   |
| –      | T14                                | TP2<br>TP13<br>TP27 | F-A, S-B               | Category B<br>SW2       | –                | Toxic if swallowed, by skin contact or by inhalation. Causes burns to skin, eyes and mucous membranes.   | 3289   |
| –      | T11                                | TP2<br>TP27         | F-A, S-B               | Category B<br>SW2       | –                | See entry above.   | 3289   |



Part 3 – Dangerous Goods List, special provisions and exceptions

Chapter 3.2 – Dangerous Goods List

| UN No. | Proper shipping name (PSN)   | Class or division | Subsidiary hazard(s) | Packing group  | Special provisions | Limited and excepted quantity provisions |                     | Packing       |              | IBC           |               |
|--------|--|-------------------|----------------------|----------------|--------------------|--|---------------------|---------------|--------------|---------------|---------------|
|        |  |                   |                      |                |                    | Limited quantities                       | Excepted quantities | Instructions  | Provisions   | Instructions  | Provisions    |
| (1)    | (2)<br>3.1.2   | (3)<br>2.0        | (4)<br>2.0           | (5)<br>2.0.1.3 | (6)<br>3.3         | (7a)<br>3.4                              | (7b)<br>3.5         | (8)<br>4.1.4  | (9)<br>4.1.4 | (10)<br>4.1.4 | (11)<br>4.1.4 |
| 3290   | TOXIC SOLID, CORROSIVE, INORGANIC, N.O.S.  | 6.1               | 8                    | I              | 274                | 0  | E5                  | P002          | -            | IBC99         | -             |
| 3290   | TOXIC SOLID, CORROSIVE, INORGANIC, N.O.S.  | 6.1               | 8                    | II             | 274                | 500 g                                    | E4                  | P002          | -            | IBC06         | B21           |
| 3291   | CLINICAL WASTE, UNSPECIFIED, N.O.S. or (BIO) MEDICAL WASTE, N.O.S. or REGULATED MEDICAL WASTE, N.O.S.      | 6.2               | -                    | -              | -                  | 0  | E0                  | P621<br>LP621 | -            | IBC620        | -             |
| 3292   | BATTERIES, CONTAINING METALLIC SODIUM OR SODIUM ALLOY or CELLS, CONTAINING METALLIC SODIUM OR SODIUM ALLOY | 4.3               | -                    | -              | 239<br>401         | 0  | E0                  | P408          | -            | -             | -             |
| 3293   | HYDRAZINE, AQUEOUS SOLUTION with not more than 37% hydrazine, by mass                                      | 6.1               | -                    | III            | 223                | 5 L                                      | E1                  | P001<br>LP01  | -            | IBC03         | -             |
| 3294   | HYDROGEN CYANIDE, SOLUTION IN ALCOHOL with not more than 45% hydrogen cyanide                              | 6.1               | 3<br>P               | I              | 900                | 0  | E0                  | P601          | -            | -             | -             |
| 3295   | HYDROCARBONS, LIQUID, N.O.S.   | 3                 | -                    | I              | -                  | 500 mL                                   | E3                  | P001          | -            | -             | -             |
| 3295   | HYDROCARBONS, LIQUID, N.O.S.   | 3                 | -                    | II             | -                  | 1 L                                      | E2                  | P001          | -            | IBC02         | -             |
| 3295   | HYDROCARBONS, LIQUID, N.O.S.   | 3                 | -                    | III            | 223                | 5 L                                      | E1                  | P001<br>LP01  | -            | IBC03         | -             |
| 3296   | HEPTAFLUOROPROPANE (REFRIGERANT GAS R 227)   | 2.2               | -                    | -              | -                  | 120 mL                                   | E1                  | P200          | -            | -             | -             |
| 3297   | ETHYLENE OXIDE AND CHLOROTETRAFLUOROETHANE MIXTURE with not more than 8.8% ethylene oxide                  | 2.2               | -                    | -              | 392                | 120 mL                                   | E1                  | P200          | -            | -             | -             |
| 3298   | ETHYLENE OXIDE AND PENTAFLUOROETHANE MIXTURE with not more than 7.9% ethylene oxide                        | 2.2               | -                    | -              | 392                | 120 mL                                   | E1                  | P200          | -            | -             | -             |
| 3299   | ETHYLENE OXIDE AND TETRAFLUOROETHANE MIXTURE with not more than 5.6% ethylene oxide                        | 2.2               | -                    | -              | 392                | 120 mL                                   | E1                  | P200          | -            | -             | -             |
| 3300   | ETHYLENE OXIDE AND CARBON DIOXIDE MIXTURE with more than 87% ethylene oxide                                | 2.3               | 2.1                  | -              | -                  | 0  | E0                  | P200          | -            | -             | -             |
| 3301   | CORROSIVE LIQUID, SELF-HEATING, N.O.S.   | 8                 | 4.2                  | I              | 274                | 0  | E0                  | P001          | -            | -             | -             |
| 3301   | CORROSIVE LIQUID, SELF-HEATING, N.O.S.   | 8                 | 4.2                  | II             | 274                | 0  | E2                  | P001          | -            | -             | -             |

| UN No. | Portable tanks and bulk containers |                    | EmS                    | Stowage and handling    | Segregation      | Properties and observations  | UN No. |
|--------|------------------------------------|--------------------|------------------------|-------------------------|------------------|--|--------|
|        | Tank instructions                  | Provisions         |                        |                         |                  |  |        |
| (12)   | (13)<br>4.2.5<br>4.3               | (14)<br>4.2.5      | (15)<br>5.4.3.4<br>7.8 | (16a)<br>7.1<br>7.3-7.7 | (16b)<br>7.2-7.7 | (17)   | (18)   |
| -      | T6                                 | TP33               | F-A, S-B               | Category B<br>SW2       | -                | Toxic if swallowed, by skin contact or by inhalation. Causes burns to skin, eyes and mucous membranes.   | 3290   |
| -      | T3                                 | TP33               | F-A, S-B               | Category B<br>SW2       | -                | See entry above.   | 3290   |
| -      | BK2                                | -                  | F-A, S-T               | SW28                    | -                | Derived from the medical treatment of animals, humans or from bio-research.  | 3291   |
| -      | -                                  | -                  | F-G, S-P               | Category A<br>H1        | SG26             | Series of hermetically sealed metal cells containing sodium, electrically connected and secured within a metal casing. "Cold" batteries (batteries containing elemental sodium only in the solid state) are electrically inert. Batteries are activated by heating to between 300°C and 350°C before operating to produce electricity. Activated batteries (i.e. "hot" batteries containing liquid elemental sodium) may cause fire through short-circuit of the terminals. Batteries or cells should not be offered for transport at a temperature such that liquid elemental sodium is present in the battery or cell unless approved, and under conditions of transport established by the competent authority. | 3292   |
| -      | T4                                 | TP1                | F-A, S-A               | Category A              | SGG18<br>SG35    | Colourless liquid. Reacts violently with acids. Toxic if swallowed, by skin contact or by inhalation.  | 3293   |
| -      | T14                                | TP2<br>TP13        | F-E, S-D               | Category D<br>SW2       | -                | Flammable solution, evolving extremely toxic flammable vapours. Miscible with water. Highly toxic if swallowed, by skin contact or by inhalation. Transport of HYDROGEN CYANIDE, SOLUTION IN ALCOHOL with more than 45% hydrogen cyanide is prohibited.  | 3294   |
| -      | T11                                | TP1<br>TP8<br>TP28 | F-E, S-D               | Category E              | -                | Immiscible with water.   | 3295   |
| -      | T7                                 | TP1<br>TP8<br>TP28 | F-E, S-D               | Category B              | -                | See entry above.   | 3295   |
| -      | T4                                 | TP1<br>TP29        | F-E, S-D               | Category A              | -                | See entry above.   | 3295   |
| -      | T50                                | -                  | F-C, S-V               | Category A              | -                | Non-flammable compressed gas. Heavier than air (1.4).  | 3296   |
| -      | T50                                | -                  | F-C, S-V               | Category A              | -                | Liquefied, non-flammable, colourless gas with an ether-like odour. Much heavier than air.  | 3297   |
| -      | T50                                | -                  | F-C, S-V               | Category A              | -                | Liquefied, non-flammable, colourless gas with an ether-like odour. Much heavier than air.  | 3298   |
| -      | T50                                | -                  | F-C, S-V               | Category A              | -                | Liquefied, non-flammable, colourless gas with an ether-like odour. Much heavier than air.  | 3299   |
| -      | -                                  | -                  | F-D, S-U               | Category D<br>SW2       | -                | Liquefied, flammable, toxic colourless gas with an ether-like odour. Heavier than air (1.5).   | 3300   |
| -      | -                                  | -                  | F-A, S-J               | Category D              | -                | Causes burns to skin, eyes and mucous membranes.   | 3301   |
| -      | -                                  | -                  | F-A, S-J               | Category D              | -                | See entry above.   | 3301   |

Part 3 – Dangerous Goods List, special provisions and exceptions

Chapter 3.2 – Dangerous Goods List

| UN No. | Proper shipping name (PSN)  | Class or division | Subsidiary hazard(s) | Packing group  | Special provisions | Limited and excepted quantity provisions |                          | Packing          |                | IBC               |                 |
|--------|---|-------------------|----------------------|----------------|--------------------|--|--------------------------|------------------|----------------|-------------------|-----------------|
|        |   |                   |                      |                |                    | Limited quantities (7a)                  | Excepted quantities (7b) | Instructions (8) | Provisions (9) | Instructions (10) | Provisions (11) |
| (1)    | (2)<br>3.1.2  | (3)<br>2.0        | (4)<br>2.0           | (5)<br>2.0.1.3 | (6)<br>3.3         | (7a)<br>3.4                              | (7b)<br>3.5              | (8)<br>4.1.4     | (9)<br>4.1.4   | (10)<br>4.1.4     | (11)<br>4.1.4   |
| 3302   | 2-DIMETHYLAMINOETHYL ACRYLATE, STABILIZED   | 6.1               | –                    | II             | 386                | 100 mL                                   | E4                       | P001             | –              | IBC02             | –               |
| 3303   | COMPRESSED GAS, TOXIC, OXIDIZING, N.O.S.  | 2.3               | 5.1                  | –              | 274                | 0  | E0                       | P200             | –              | –                 | –               |
| 3304   | COMPRESSED GAS, TOXIC, CORROSIVE, N.O.S.  | 2.3               | 8                    | –              | 274                | 0  | E0                       | P200             | –              | –                 | –               |
| 3305   | COMPRESSED GAS, TOXIC, FLAMMABLE, CORROSIVE, N.O.S.   | 2.3               | 2.1/8                | –              | 274                | 0  | E0                       | P200             | –              | –                 | –               |
| 3306   | COMPRESSED GAS, TOXIC, OXIDIZING, CORROSIVE, N.O.S.   | 2.3               | 5.1/8                | –              | 274                | 0  | E0                       | P200             | –              | –                 | –               |
| 3307   | LIQUEFIED GAS, TOXIC, OXIDIZING, N.O.S.   | 2.3               | 5.1                  | –              | 274                | 0  | E0                       | P200             | –              | –                 | –               |
| 3308   | LIQUEFIED GAS, TOXIC, CORROSIVE, N.O.S.   | 2.3               | 8                    | –              | 274                | 0  | E0                       | P200             | –              | –                 | –               |
| 3309   | LIQUEFIED GAS, TOXIC, FLAMMABLE, CORROSIVE, N.O.S.  | 2.3               | 2.1/8                | –              | 274                | 0  | E0                       | P200             | –              | –                 | –               |
| 3310   | LIQUEFIED GAS, TOXIC, OXIDIZING, CORROSIVE, N.O.S.  | 2.3               | 5.1/8                | –              | 274                | 0  | E0                       | P200             | –              | –                 | –               |
| 3311   | GAS, REFRIGERATED LIQUID, OXIDIZING, N.O.S.   | 2.2               | 5.1                  | –              | 274                | 0  | E0                       | P203             | –              | –                 | –               |
| 3312   | GAS, REFRIGERATED LIQUID, FLAMMABLE, N.O.S.   | 2.1               | –                    | –              | 274                | 0  | E0                       | P203             | –              | –                 | –               |
| 3313   | ORGANIC PIGMENTS, SELF-HEATING  | 4.2               | –                    | II             | –                  | 0  | E2                       | P002             | –              | IBC08             | B4<br>B21       |
| 3313   | ORGANIC PIGMENTS, SELF-HEATING  | 4.2               | –                    | III            | 223                | 0  | E1                       | P002<br>LP02     | –              | IBC08             | B3              |
| 3314   | PLASTICS MOULDING COMPOUND in dough, sheet or extruded rope form, evolving flammable vapour | 9                 | –                    | III            | 207<br>965         | 5 kg                                     | E1                       | P002             | PP14           | IBC08             | B3<br>B6        |
| 3315   | CHEMICAL SAMPLE, TOXIC  | 6.1               | –                    | I              | 250                | 0  | E0                       | P099             | –              | –                 | –               |
| 3316   | CHEMICAL KIT or FIRST AID KIT   | 9                 | –                    | –              | 251<br>340         | See<br>SP251                             | See<br>SP340             | P901             | –              | –                 | –               |
| 3317   | 2-AMINO-4,6-DINITROPHENOL, WETTED with not less than 20% water, by mass                     | 4.1               | –                    | I              | 28                 | 0  | E0                       | P406             | PP26<br>PP31   | –                 | –               |

| UN No. | Portable tanks and bulk containers |                 | EmS                    | Stowage and handling     | Segregation      | Properties and observations  | UN No. |
|--------|------------------------------------|-----------------|------------------------|--------------------------|------------------|--|--------|
|        | Tank instructions (12)             | Provisions (14) |                        |                          |                  |  |        |
| (1)    | (13)<br>4.2.5<br>4.3               | (14)<br>4.2.5   | (15)<br>5.4.3.4<br>7.8 | (16a)<br>7.1<br>7.3–7.7  | (16b)<br>7.2–7.7 | (17)   | (18)   |
| –      | T7                                 | TP2             | F-A, S-A               | Category D<br>SW1        | –                | Colourless to light yellow liquid. Acrid odour. Miscible with water. Causes tears. Stabilized with hydroquinone derivatives. Hydrolyses in water to give off acrylic acid and dimethylaminoethanol. Toxic if swallowed, by skin contact or by inhalation.  | 3302   |
| –      | –                                  | –               | F-C, S-W               | Category D<br>SW2        | –                | –  | 3303   |
| –      | –                                  | –               | F-C, S-U               | Category D<br>SW2        | –                | –  | 3304   |
| –      | –                                  | –               | F-D, S-U               | Category D<br>SW2        | SG4<br>SG9       | –  | 3305   |
| –      | –                                  | –               | F-C, S-W               | Category D<br>SW2        | SG6<br>SG19      | –  | 3306   |
| –      | –                                  | –               | F-C, S-W               | Category D<br>SW2        | –                | –  | 3307   |
| –      | –                                  | –               | F-C, S-U               | Category D<br>SW2        | –                | –  | 3308   |
| –      | –                                  | –               | F-D, S-U               | Category D<br>SW2        | SG4<br>SG9       | –  | 3309   |
| –      | –                                  | –               | F-C, S-W               | Category D<br>SW2        | SG6<br>SG19      | –  | 3310   |
| –      | T75                                | TP5<br>TP22     | F-C, S-W               | Category D               | –                | –  | 3311   |
| –      | T75                                | TP5             | F-D, S-U               | Category D<br>SW2        | –                | –  | 3312   |
| –      | T3                                 | TP33            | F-A, S-J               | Category C               | –                | Self-heating coloured powder or granules. Odourless. Liable to self-heating or spontaneous combustion.   | 3313   |
| –      | T1                                 | TP33            | F-A, S-J               | Category C               | –                | See entry above.   | 3313   |
| –      | –                                  | –               | F-A, S-I               | Category E<br>SW1<br>SW6 | SG5<br>SG14      | A moulding material consisting predominantly of polystyrene, poly(methyl methacrylate) or other polymeric material and containing 5% to 8% of a volatile hydrocarbon which is predominantly pentane. During storage, a small proportion of this pentane is released to the atmosphere; this proportion increases at elevated temperatures.   | 3314   |
| –      | –                                  | –               | F-A, S-A               | Category D<br>SW2        | –                | This entry may only be used for samples of chemicals taken for analysis in connection with the implementation of the Convention on the Prohibition of the Development, Production, Stockpiling and Use of Chemical Weapons and on their Destruction. The transport of substances under this entry shall be in accordance with the chain of custody and security procedures specified by the Organization for the Prohibition of Chemical Weapons. The chemical sample may only be transported providing prior approval has been granted by the competent authority or the Director General of the Organization for the Prohibition of Chemical Weapons. During transport, the packaging shall be accompanied by a copy of the document of approval for transport, showing the quantity limitations and the packing requirements. | 3315   |
| –      | –                                  | –               | F-A, S-P               | Category A               | –                | –  | 3316   |
| –      | –                                  | –               | F-B, S-J               | Category D               | SG7<br>SG30      | Desensitized explosive. Red crystals. Insoluble in water. Explosive in the dry state. May form extremely sensitive compounds with heavy metals or their salts. When involved in a fire, evolves toxic fumes; in closed compartments these fumes may form an explosive mixture with air. Harmful if swallowed or by skin contact.   | 3317   |



Part 3 – Dangerous Goods List, special provisions and exceptions

Chapter 3.2 – Dangerous Goods List

| UN No. | Proper shipping name (PSN)   | Class or division | Subsidiary hazard(s) | Packing group  | Special provisions | Limited and excepted quantity provisions |                          | Packing          |                | IBC               |                 |
|--------|--|-------------------|----------------------|----------------|--------------------|--|--------------------------|------------------|----------------|-------------------|-----------------|
|        |  |                   |                      |                |                    | Limited quantities (7a)                  | Excepted quantities (7b) | Instructions (8) | Provisions (9) | Instructions (10) | Provisions (11) |
| (1)    | (2)<br>3.1.2   | (3)<br>2.0        | (4)<br>2.0           | (5)<br>2.0.1.3 | (6)<br>3.3         | (7a)<br>3.4                              | (7b)<br>3.5              | (8)<br>4.1.4     | (9)<br>4.1.4   | (10)<br>4.1.4     | (11)<br>4.1.4   |
| 3318   | AMMONIA SOLUTION, relative density less than 0.880 at 15°C in water, with more than 50% ammonia  | 2.3               | 8<br>P               | –              | 23                 | 0  | E0                       | P200             | –              | –                 | –               |
| 3319   | NITROGLYCERIN MIXTURE, DESENSITIZED, SOLID, N.O.S. with more than 2% but not more than 10% nitroglycerin, by mass                          | 4.1               | –                    | II             | 28<br>272<br>274   | 0  | E0                       | P099             | –              | –                 | –               |
| 3320   | SODIUM BOROHYDRIDE AND SODIUM HYDROXIDE SOLUTION with not more than 12% sodium borohydride and not more than 40% sodium hydroxide, by mass | 8                 | –                    | II             | –                  | 1 L                                      | E2                       | P001             | –              | IBC02             | –               |
| 3320   | SODIUM BOROHYDRIDE AND SODIUM HYDROXIDE SOLUTION with not more than 12% sodium borohydride and not more than 40% sodium hydroxide, by mass | 8                 | –                    | III            | 223                | 5 L                                      | E1                       | P001<br>LP01     | –              | IBC03             | –               |
| 3321   | RADIOACTIVE MATERIAL, LOW SPECIFIC ACTIVITY (LSA-II), non fissile or fissile-excepted  | 7                 | See<br>SP172         | –              | 172<br>317<br>325  | 0  | E0                       | See<br>4.1.9     | See<br>4.1.9   | See<br>4.1.9      | See<br>4.1.9    |
| 3322   | RADIOACTIVE MATERIAL, LOW SPECIFIC ACTIVITY (LSA-III), non fissile or fissile-excepted   | 7                 | See<br>SP172         | –              | 172<br>317<br>325  | 0  | E0                       | See<br>4.1.9     | See<br>4.1.9   | See<br>4.1.9      | See<br>4.1.9    |
| 3323   | RADIOACTIVE MATERIAL, TYPE C PACKAGE, non fissile or fissile-excepted  | 7                 | See<br>SP172         | –              | 172<br>317<br>325  | 0  | E0                       | See<br>4.1.9     | See<br>4.1.9   | See<br>4.1.9      | See<br>4.1.9    |
| 3324   | RADIOACTIVE MATERIAL, LOW SPECIFIC ACTIVITY (LSA-II), FISSILE  | 7                 | See<br>SP172         | –              | 172<br>326         | 0  | E0                       | See<br>4.1.9     | See<br>4.1.9   | See<br>4.1.9      | See<br>4.1.9    |
| 3325   | RADIOACTIVE MATERIAL, LOW SPECIFIC ACTIVITY, (LSA-III), FISSILE  | 7                 | See<br>SP172         | –              | 172<br>326         | 0  | E0                       | See<br>4.1.9     | See<br>4.1.9   | See<br>4.1.9      | See<br>4.1.9    |
| 3326   | RADIOACTIVE MATERIAL, SURFACE CONTAMINATED OBJECTS (SCO-I or SCO-II), FISSILE  | 7                 | See<br>SP172         | –              | 172<br>326         | 0  | E0                       | See<br>4.1.9     | See<br>4.1.9   | See<br>4.1.9      | See<br>4.1.9    |
| 3327   | RADIOACTIVE MATERIAL, TYPE A PACKAGE, FISSILE, non-special form  | 7                 | See<br>SP172         | –              | 172<br>326         | 0  | E0                       | See<br>4.1.9     | See<br>4.1.9   | See<br>4.1.9      | See<br>4.1.9    |
| 3328   | RADIOACTIVE MATERIAL, TYPE B(U) PACKAGE, FISSILE   | 7                 | See<br>SP172         | –              | 172<br>326         | 0  | E0                       | See<br>4.1.9     | See<br>4.1.9   | See<br>4.1.9      | See<br>4.1.9    |
| 3329   | RADIOACTIVE MATERIAL, TYPE B(M) PACKAGE, FISSILE   | 7                 | See<br>SP172         | –              | 172<br>326         | 0  | E0                       | See<br>4.1.9     | See<br>4.1.9   | See<br>4.1.9      | See<br>4.1.9    |

| UN No. | Portable tanks and bulk containers |                 | EmS                    | Stowage and handling    | Segregation                        | Properties and observations | UN No.   |      |
|--------|------------------------------------|-----------------|------------------------|-------------------------|------------------------------------|-----------------------------|--|------|
|        | Tank instructions (12)             | Provisions (14) |                        |                         |                                    |                             |  |      |
| (12)   | (13)<br>4.2.5<br>4.3               | (14)<br>4.2.5   | (15)<br>5.4.3.4<br>7.8 | (16a)<br>7.1<br>7.3–7.7 | (16b)<br>7.2–7.7                   | (17)                        | (18)   |      |
| 3318   | –                                  | T50             | –                      | F-C, S-U                | Category D<br>SW2                  | SGG18<br>SG35<br>SG46       | Highly concentrated solution in water of a non-flammable, toxic and corrosive gas with a pungent odour. Even though this substance has a flammability hazard, it only exhibits such hazard under extreme fire conditions in confined areas. Reacts violently with acids. Highly irritating to skin, eyes and mucous membranes. Suffocating in low concentrations.  | 3318 |
| 3319   | –                                  | –               | –                      | F-B, S-J                | Category E                         | –                           | Desensitized explosive with lactose, glucose or cellulose. White solid. Soluble in water. When involved in a fire, the nitroglycerin may accumulate and may produce an explosion. Contact with water may dissolve the desensitizer (lactose or glucose), causing migration and accumulation of the nitroglycerin, which may explode. Nitroglycerin is more dense than water. When involved in a fire, evolves toxic fumes; in closed compartments these fumes may form an explosive mixture with air. Inhalation of vapours may cause headaches, dizziness and fainting. | 3319 |
| 3320   | –                                  | T7              | TP2                    | F-A, S-B                | Category A                         | SGG18<br>SG35               | Off-white clear liquid with a slight hydrocarbon odour. Reacts violently with acids. In contact with acids or if diluted with large amount of water, evolves hydrogen gas and heat. Causes burns to skin, eyes and mucous membranes.   | 3320 |
| 3320   | –                                  | T4              | TP2                    | F-A, S-B                | Category A                         | SGG18<br>SG35               | See entry above.   | 3320 |
| 3321   | –                                  | T5              | TP4                    | F-I, S-S                | Category A<br>SW20<br>SW21         | –                           | See 1.5.1.   | 3321 |
| 3322   | –                                  | T5              | TP4                    | F-I, S-S                | Category A<br>SW21                 | –                           | See 1.5.1.   | 3322 |
| 3323   | –                                  | –               | –                      | F-I, S-S                | Category A<br>SW12                 | –                           | See 1.5.1. For ships transporting an INF cargo as defined in regulation VII/14 of the SOLAS Convention, 1974, as amended, refer also to the INF Code.  | 3323 |
| 3324   | –                                  | –               | –                      | F-I, S-S                | Category A<br>SW12<br>SW20<br>SW21 | –                           | See 1.5.1.   | 3324 |
| 3325   | –                                  | –               | –                      | F-I, S-S                | Category A<br>SW12<br>SW21         | –                           | See 1.5.1.   | 3325 |
| 3326   | –                                  | –               | –                      | F-I, S-S                | Category A<br>SW12                 | –                           | See 1.5.1.   | 3326 |
| 3327   | –                                  | –               | –                      | F-I, S-S                | Category A<br>SW12<br>SW20<br>SW21 | –                           | See 1.5.1.   | 3327 |
| 3328   | –                                  | –               | –                      | F-I, S-S                | Category A<br>SW12                 | –                           | See 1.5.1. For ships transporting an INF cargo as defined in regulation VII/14 of the SOLAS Convention, 1974, as amended, refer also to the INF Code.  | 3328 |
| 3329   | –                                  | –               | –                      | F-I, S-S                | Category A<br>SW12                 | –                           | See 1.5.1. For ships transporting an INF cargo as defined in regulation VII/14 of the SOLAS Convention, 1974, as amended, refer also to the INF Code.  | 3329 |

Part 3 – Dangerous Goods List, special provisions and exceptions

Chapter 3.2 – Dangerous Goods List

| UN No. | Proper shipping name (PSN)  | Class or division | Subsidiary hazard(s) | Packing group  | Special provisions | Limited and excepted quantity provisions |                     | Packing      |              | IBC           |               |
|--------|---|-------------------|----------------------|----------------|--------------------|--|---------------------|--------------|--------------|---------------|---------------|
|        |   |                   |                      |                |                    | Limited quantities                       | Excepted quantities | Instructions | Provisions   | Instructions  | Provisions    |
| (1)    | (2)<br>3.1.2  | (3)<br>2.0        | (4)<br>2.0           | (5)<br>2.0.1.3 | (6)<br>3.3         | (7a)<br>3.4                              | (7b)<br>3.5         | (8)<br>4.1.4 | (9)<br>4.1.4 | (10)<br>4.1.4 | (11)<br>4.1.4 |
| 3330   | RADIOACTIVE MATERIAL, TYPE C PACKAGE, FISSILE   | 7                 | See SP172            | –              | 172<br>326         | 0  | E0                  | See 4.1.9    | See 4.1.9    | See 4.1.9     | See 4.1.9     |
| 3331   | RADIOACTIVE MATERIAL, TRANSPORTED UNDER SPECIAL ARRANGEMENT, FISSILE                  | 7                 | See SP172            | –              | 172<br>326         | 0  | E0                  | See 4.1.9    | See 4.1.9    | See 4.1.9     | See 4.1.9     |
| 3332   | RADIOACTIVE MATERIAL, TYPE A PACKAGE, SPECIAL FORM, non fissile or fissile-excepted   | 7                 | See SP172            | –              | 172<br>317         | 0  | E0                  | See 4.1.9    | See 4.1.9    | See 4.1.9     | See 4.1.9     |
| 3333   | RADIOACTIVE MATERIAL, TYPE A PACKAGE, SPECIAL FORM, FISSILE                           | 7                 | See SP172            | –              | 172                | 0  | E0                  | See 4.1.9    | See 4.1.9    | See 4.1.9     | See 4.1.9     |
| 3334   | AVIATION REGULATED LIQUID, N.O.S.   | 9                 | –                    | –              | 960                | –  | –                   | –            | –            | –             | –             |
| 3335   | AVIATION REGULATED SOLID, N.O.S.  | 9                 | –                    | –              | 960                | –  | –                   | –            | –            | –             | –             |
| 3336   | MERCAPTANS, LIQUID, FLAMMABLE, N.O.S. or MERCAPTAN MIXTURE, LIQUID, FLAMMABLE, N.O.S. | 3                 | –                    | I              | 274                | 0  | E0                  | P001         | –            | –             | –             |
| 3336   | MERCAPTANS, LIQUID, FLAMMABLE, N.O.S. or MERCAPTAN MIXTURE, LIQUID, FLAMMABLE, N.O.S. | 3                 | –                    | II             | 274                | 1 L                                      | E2                  | P001         | –            | IBC02         | –             |
| 3336   | MERCAPTANS, LIQUID, FLAMMABLE, N.O.S. or MERCAPTAN MIXTURE, LIQUID, FLAMMABLE, N.O.S. | 3                 | –                    | III            | 223<br>274         | 5 L                                      | E1                  | P001<br>LP01 | –            | IBC03         | –             |
| 3337   | REFRIGERANT GAS R 404A  | 2.2               | –                    | –              | –                  | 120 mL                                   | E1                  | P200         | –            | –             | –             |
| 3338   | REFRIGERANT GAS R 407A  | 2.2               | –                    | –              | –                  | 120 mL                                   | E1                  | P200         | –            | –             | –             |
| 3339   | REFRIGERANT GAS R 407B  | 2.2               | –                    | –              | –                  | 120 mL                                   | E1                  | P200         | –            | –             | –             |
| 3340   | REFRIGERANT GAS R 407C  | 2.2               | –                    | –              | –                  | 120 mL                                   | E1                  | P200         | –            | –             | –             |
| 3341   | THIOUREA DIOXIDE  | 4.2               | –                    | II             | –                  | 0  | E2                  | P002         | PP31         | IBC06         | B21           |
| 3341   | THIOUREA DIOXIDE  | 4.2               | –                    | III            | 223                | 0  | E1                  | P002<br>LP02 | PP31         | IBC08         | B3            |

| UN No. | Portable tanks and bulk containers |                    | EmS                    | Stowage and handling    | Segregation      | Properties and observations  | UN No. |
|--------|------------------------------------|--------------------|------------------------|-------------------------|------------------|--|--------|
|        | Tank instructions                  | Provisions         |                        |                         |                  |  |        |
| (12)   | (13)<br>4.2.5<br>4.3               | (14)<br>4.2.5      | (15)<br>5.4.3.4<br>7.8 | (16a)<br>7.1<br>7.3–7.7 | (16b)<br>7.2–7.7 | (17)   | (18)   |
| –      | –                                  | –                  | F-I, S-S               | Category A<br>SW12      | –                | See 1.5.1. For ships transporting an INF cargo as defined in regulation VII/14 of the SOLAS Convention, 1974, as amended, refer also to the INF Code.  | 3330   |
| –      | –                                  | –                  | F-I, S-S               | Category A<br>SW13      | –                | See 1.5.1. For ships transporting an INF cargo as defined in regulation VII/14 of the SOLAS Convention, 1974, as amended, refer also to the INF Code.  | 3331   |
| –      | –                                  | –                  | F-I, S-S               | Category A              | –                | See 1.5.1.   | 3332   |
| –      | –                                  | –                  | F-I, S-S               | Category A<br>SW12      | –                | See 1.5.1.   | 3333   |
| –      | –                                  | –                  | –                      | –                       | –                | Not subject to the provisions of this Code but may be subject to provisions governing the transport of dangerous goods by other modes.   | 3334   |
| –      | –                                  | –                  | –                      | –                       | –                | Not subject to the provisions of this Code but may be subject to provisions governing the transport of dangerous goods by other modes.   | 3335   |
| –      | T11                                | TP2                | F-E, S-D               | Category E              | SG50<br>SG57     | Colourless to yellow liquids with a garlic odour. Immiscible with water.   | 3336   |
| –      | T7                                 | TP1<br>TP8<br>TP28 | F-E, S-D               | Category B              | SG50<br>SG57     | See entry above.   | 3336   |
| –      | T4                                 | TP1<br>TP29        | F-E, S-D               | Category B              | SG50<br>SG57     | See entry above.   | 3336   |
| –      | T50                                | –                  | F-C, S-V               | Category A              | –                | Liquefied, non-flammable, colourless gas with a faint ether-like odour. Heavier than air (1.06). Very high exposures may cause anaesthetic effects and asphyxiation.   | 3337   |
| –      | T50                                | –                  | F-C, S-V               | Category A              | –                | Liquefied, non-flammable, colourless gas with a faint ether-like odour. Heavier than air (1.17). Very high exposures may cause anaesthetic effects and asphyxiation.   | 3338   |
| –      | T50                                | –                  | F-C, S-V               | Category A              | –                | Liquefied, non-flammable, colourless gas with a faint ether-like odour. Heavier than air (1.19). Very high exposures may cause anaesthetic effects and asphyxiation.   | 3339   |
| –      | T50                                | –                  | F-C, S-V               | Category A              | –                | Liquefied, non-flammable, colourless gas with a faint ether-like odour. Heavier than air (1.16). Very high exposures may cause anaesthetic effects and asphyxiation.   | 3340   |
| –      | T3                                 | TP33               | F-A, S-J               | Category D              | –                | White to yellow-white crystalline powder. Virtually odourless. Strong reducing agent. Violent exothermic decomposition above 100°C with emission of large amounts of sulphur oxides, ammonia, carbon monoxide, carbon dioxide, nitrogen oxides and hydrogen sulphide. Extended exposure to temperatures above 50°C and moisture may cause visible decomposition. Dust irritating to skin, eyes and mucous membranes. | 3341   |
| –      | T1                                 | TP33               | F-A, S-J               | Category D              | –                | See entry above.   | 3341   |

Part 3 – Dangerous Goods List, special provisions and exceptions

Chapter 3.2 – Dangerous Goods List

| UN No. | Proper shipping name (PSN)  | Class or division | Subsidiary hazard(s) | Packing group  | Special provisions | Limited and excepted quantity provisions |                     | Packing      |              | IBC           |               |
|--------|---|-------------------|----------------------|----------------|--------------------|--|---------------------|--------------|--------------|---------------|---------------|
|        |   |                   |                      |                |                    | Limited quantities                       | Excepted quantities | Instructions | Provisions   | Instructions  | Provisions    |
| (1)    | (2)<br>3.1.2  | (3)<br>2.0        | (4)<br>2.0           | (5)<br>2.0.1.3 | (6)<br>3.3         | (7a)<br>3.4                              | (7b)<br>3.5         | (8)<br>4.1.4 | (9)<br>4.1.4 | (10)<br>4.1.4 | (11)<br>4.1.4 |
| 3342   | XANTHATES   | 4.2               | –                    | II             | –                  | 0  | E2                  | P002         | PP31         | IBC06         | B21           |
| 3342   | XANTHATES   | 4.2               | –                    | III            | 223                | 0  | E1                  | P002<br>LP02 | PP31         | IBC08         | B3            |
| △ 3343 | NITROGLYCERIN MIXTURE, DESENSITIZED, LIQUID, FLAMMABLE, N.O.S. with not more than 30% nitroglycerin, by mass  | 3                 | –                    | –              | 28<br>274<br>278   | 0  | E0                  | P099         | –            | –             | –             |
| △ 3344 | PENTAERYTHRITOL TETRANITRATE (PENTAERYTHRITOL TETRANITRATE; PETN) MIXTURE, DESENSITIZED, SOLID, N.O.S. with more than 10% but not more than 20% PETN, by mass | 4.1               | –                    | II             | 28<br>272<br>274   | 0  | E0                  | P406         | PP26<br>PP80 | –             | –             |
| 3345   | PHENOXYACETIC ACID DERIVATIVE PESTICIDE, SOLID, TOXIC   | 6.1               | –                    | I              | 61<br>274          | 0  | E5                  | P002         | –            | IBC07         | B1            |
| 3345   | PHENOXYACETIC ACID DERIVATIVE PESTICIDE, SOLID, TOXIC   | 6.1               | –                    | II             | 61<br>274          | 500 g                                    | E4                  | P002         | –            | IBC08         | B4<br>B21     |
| 3345   | PHENOXYACETIC ACID DERIVATIVE PESTICIDE, SOLID, TOXIC   | 6.1               | –                    | III            | 61<br>223<br>274   | 5 kg                                     | E1                  | P002<br>LP02 | –            | IBC08         | B3            |
| 3346   | PHENOXYACETIC ACID DERIVATIVE PESTICIDE, LIQUID, FLAMMABLE, TOXIC flashpoint less than 23°C   | 3                 | 6.1                  | I              | 61<br>274          | 0  | E0                  | P001         | –            | –             | –             |
| 3346   | PHENOXYACETIC ACID DERIVATIVE PESTICIDE, LIQUID, FLAMMABLE, TOXIC flashpoint less than 23°C   | 3                 | 6.1                  | II             | 61<br>274          | 1 L                                      | E2                  | P001         | –            | IBC02         | –             |
| 3347   | PHENOXYACETIC ACID DERIVATIVE PESTICIDE, LIQUID, TOXIC, FLAMMABLE, flashpoint not less than 23°C  | 6.1               | 3                    | I              | 61<br>274          | 0  | E5                  | P001         | –            | –             | –             |
| 3347   | PHENOXYACETIC ACID DERIVATIVE PESTICIDE, LIQUID, TOXIC, FLAMMABLE, flashpoint not less than 23°C  | 6.1               | 3                    | II             | 61<br>274          | 100 mL                                   | E4                  | P001         | –            | IBC02         | –             |
| 3347   | PHENOXYACETIC ACID DERIVATIVE PESTICIDE, LIQUID, TOXIC, FLAMMABLE, flashpoint not less than 23°C  | 6.1               | 3                    | III            | 61<br>223<br>274   | 5 L                                      | E1                  | P001         | –            | IBC03         | –             |
| 3348   | PHENOXYACETIC ACID DERIVATIVE PESTICIDE, LIQUID, TOXIC  | 6.1               | –                    | I              | 61<br>274          | 0  | E5                  | P001         | –            | –             | –             |
| 3348   | PHENOXYACETIC ACID DERIVATIVE PESTICIDE, LIQUID, TOXIC  | 6.1               | –                    | II             | 61<br>274          | 100 mL                                   | E4                  | P001         | –            | IBC02         | –             |

| UN No. | Portable tanks and bulk containers |                     | EmS                    | Stowage and handling    | Segregation      | Properties and observations   | UN No. |
|--------|------------------------------------|---------------------|------------------------|-------------------------|------------------|---|--------|
|        | Tank instructions                  | Provisions          |                        |                         |                  |   |        |
| (12)   | (13)<br>4.2.5<br>4.3               | (14)<br>4.2.5       | (15)<br>5.4.3.4<br>7.8 | (16a)<br>7.1<br>7.3–7.7 | (16b)<br>7.2–7.7 | (17)  | (18)   |
| –      | T3                                 | TP33                | F-A, S-J               | Category D<br>SW2       | –                | Hygroscopic yellow powder with an unpleasant odour. On contact with moisture, evolves highly flammable vapours such as carbon disulphide (UN 1131, which has a flashpoint of –30°C c.c. and a very low ignition temperature of 100°C). When confined, can cause an explosion due to the wide explosive limits of the vapours. Finely divided dust forms explosive mixtures in air. Care should be taken when opening cargo transport units in case carbon disulphide vapours are present. | 3342   |
| –      | T1                                 | TP33                | F-A, S-J               | Category D<br>SW2       | –                | See entry above.  | 3342   |
| –      | –                                  | –                   | F-E, S-Y               | Category D              | –                | –   | 3343   |
| –      | –                                  | –                   | F-B, S-J               | Category E              | –                | –   | 3344   |
| –      | T6                                 | TP33                | F-A, S-A               | Category A<br>SW2       | –                | Solid pesticides present a very wide range of toxic hazard. Toxic if swallowed, by skin contact or by inhalation.   | 3345   |
| –      | T3                                 | TP33                | F-A, S-A               | Category A<br>SW2       | –                | See entry above.  | 3345   |
| –      | T1                                 | TP33                | F-A, S-A               | Category A<br>SW2       | –                | See entry above.  | 3345   |
| –      | T14                                | TP2<br>TP13<br>TP27 | F-E, S-D               | Category B<br>SW2       | –                | Pesticides frequently containing petroleum or coal tar distillates, or other flammable liquids. Miscibility with water depends upon the composition. Toxic if swallowed, by skin contact or by inhalation.  | 3346   |
| –      | T11                                | TP2<br>TP13<br>TP27 | F-E, S-D               | Category B<br>SW2       | –                | See entry above.  | 3346   |
| –      | T14                                | TP2<br>TP13<br>TP27 | F-E, S-D               | Category B<br>SW2       | –                | They frequently contain petroleum or coal tar distillates, or other flammable liquids. Flashpoint and miscibility with water depend upon the composition. Toxic if swallowed, by skin contact or by inhalation.   | 3347   |
| –      | T11                                | TP2<br>TP13<br>TP27 | F-E, S-D               | Category B<br>SW2       | –                | See entry above.  | 3347   |
| –      | T7                                 | TP2<br>TP28         | F-E, S-D               | Category A<br>SW2       | –                | See entry above.  | 3347   |
| –      | T14                                | TP2<br>TP13<br>TP27 | F-A, S-A               | Category B<br>SW2       | –                | Liquid pesticides which present a very wide range of toxic hazard. Miscibility with water depends upon the composition. Toxic if swallowed, by skin contact or by inhalation.   | 3348   |
| –      | T11                                | TP2<br>TP27         | F-A, S-A               | Category B<br>SW2       | –                | See entry above.  | 3348   |

Part 3 – Dangerous Goods List, special provisions and exceptions

Chapter 3.2 – Dangerous Goods List

| UN No. | Proper shipping name (PSN)  | Class or division | Subsidiary hazard(s) | Packing group  | Special provisions | Limited and excepted quantity provisions |                     | Packing      |              | IBC           |               |
|--------|---|-------------------|----------------------|----------------|--------------------|--|---------------------|--------------|--------------|---------------|---------------|
|        |   |                   |                      |                |                    | Limited quantities                       | Excepted quantities | Instructions | Provisions   | Instructions  | Provisions    |
| (1)    | (2)<br>3.1.2  | (3)<br>2.0        | (4)<br>2.0           | (5)<br>2.0.1.3 | (6)<br>3.3         | (7a)<br>3.4                              | (7b)<br>3.5         | (8)<br>4.1.4 | (9)<br>4.1.4 | (10)<br>4.1.4 | (11)<br>4.1.4 |
| 3348   | PHENOXYACETIC ACID DERIVATIVE PESTICIDE, LIQUID, TOXIC  | 6.1               | –                    | III            | 61<br>223<br>274   | 5 L                                      | E1                  | P001<br>LP01 | –            | IBC03         | –             |
| 3349   | PYRETHROID PESTICIDE, SOLID, TOXIC  | 6.1               | –                    | I              | 61<br>274          | 0  | E5                  | P002         | –            | IBC07         | B1            |
| 3349   | PYRETHROID PESTICIDE, SOLID, TOXIC  | 6.1               | –                    | II             | 61<br>274          | 500 g                                    | E4                  | P002         | –            | IBC08         | B4<br>B21     |
| 3349   | PYRETHROID PESTICIDE, SOLID, TOXIC  | 6.1               | –                    | III            | 61<br>223<br>274   | 5 kg                                     | E1                  | P002<br>LP02 | –            | IBC08         | B3            |
| 3350   | PYRETHROID PESTICIDE, LIQUID, FLAMMABLE, TOXIC, flashpoint less than 23°C                         | 3                 | 6.1                  | I              | 61<br>274          | 0  | E0                  | P001         | –            | –             | –             |
| 3350   | PYRETHROID PESTICIDE, LIQUID, FLAMMABLE, TOXIC, flashpoint less than 23°C                         | 3                 | 6.1                  | II             | 61<br>274          | 1 L                                      | E2                  | P001         | –            | IBC02         | –             |
| 3351   | PYRETHROID PESTICIDE, LIQUID, TOXIC, FLAMMABLE, flashpoint not less than 23°C                     | 6.1               | 3                    | I              | 61<br>274          | 0  | E5                  | P001         | –            | –             | –             |
| 3351   | PYRETHROID PESTICIDE, LIQUID, TOXIC, FLAMMABLE, flashpoint not less than 23°C                     | 6.1               | 3                    | II             | 61<br>274          | 100 mL                                   | E4                  | P001         | –            | IBC02         | –             |
| 3351   | PYRETHROID PESTICIDE, LIQUID, TOXIC, FLAMMABLE, flashpoint not less than 23°C                     | 6.1               | 3                    | III            | 61<br>223<br>274   | 5 L                                      | E1                  | P001         | –            | IBC03         | –             |
| 3352   | PYRETHROID PESTICIDE, LIQUID, TOXIC   | 6.1               | –                    | I              | 61<br>274          | 0  | E5                  | P001         | –            | –             | –             |
| 3352   | PYRETHROID PESTICIDE, LIQUID, TOXIC   | 6.1               | –                    | II             | 61<br>274          | 100 mL                                   | E4                  | P001         | –            | IBC02         | –             |
| 3352   | PYRETHROID PESTICIDE, LIQUID, TOXIC   | 6.1               | –                    | III            | 61<br>223<br>274   | 5 L                                      | E1                  | P001<br>LP01 | –            | IBC03         | –             |
| 3354   | INSECTICIDE GAS, FLAMMABLE, N.O.S.  | 2.1               | –                    | –              | 274                | 0  | E0                  | P200         | –            | –             | –             |
| 3355   | INSECTICIDE GAS, TOXIC, FLAMMABLE, N.O.S.   | 2.3               | 2.1                  | –              | 274                | 0  | E0                  | P200         | –            | –             | –             |
| 3356   | OXYGEN GENERATOR, CHEMICAL  | 5.1               | –                    | –              | 284                | 0  | E0                  | P500         | –            | –             | –             |
| △ 3357 | NITROGLYCERIN MIXTURE, DESENSITIZED, LIQUID, N.O.S. with not more than 30% nitroglycerin, by mass | 3                 | –                    | II             | 28<br>274<br>288   | 0  | E0                  | P099         | –            | –             | –             |

| UN No. | Portable tanks and bulk containers |                     | EmS                    | Stowage and handling    | Segregation      | Properties and observations   | UN No.   |
|--------|------------------------------------|---------------------|------------------------|-------------------------|------------------|---|----------|
|        | Tank instructions                  | Provisions          |                        |                         |                  |   |          |
| (12)   | (13)<br>4.2.5<br>4.3               | (14)<br>4.2.5       | (15)<br>5.4.3.4<br>7.8 | (16a)<br>7.1<br>7.3–7.7 | (16b)<br>7.2–7.7 | (17)  | (18)     |
| –      | T7                                 | TP2<br>TP28         | F-A, S-A               | Category A<br>SW2       | –                | Liquid pesticides which present a very wide range of toxic hazard. Miscibility with water depends upon the composition. Toxic if swallowed, by skin contact or by inhalation.   | 3348     |
| –      | T6                                 | TP33                | F-A, S-A               | Category A<br>SW2       | –                | Solid pesticides present a very wide range of toxic hazard. Toxic if swallowed, by skin contact or by inhalation.   | 3349     |
| –      | T3                                 | TP33                | F-A, S-A               | Category A<br>SW2       | –                | See entry above.  | 3349     |
| –      | T1                                 | TP33                | F-A, S-A               | Category A<br>SW2       | –                | See entry above.  | 3349     |
| –      | T14                                | TP2<br>TP13<br>TP27 | F-E, S-D               | Category B<br>SW2       | –                | Miscibility with water depends upon the composition. Toxic if swallowed, by skin contact or by inhalation.  | 3350     |
| –      | T11                                | TP2<br>TP13<br>TP27 | F-E, S-D               | Category B<br>SW2       | –                | See entry above.  | 3350     |
| –      | T14                                | TP2<br>TP13<br>TP27 | F-E, S-D               | Category B<br>SW2       | –                | They frequently contain petroleum or coal tar distillates, or other flammable liquids. Flashpoint and miscibility with water depend upon the composition. Toxic if swallowed, by skin contact or by inhalation.   | 3351     |
| –      | T11                                | TP2<br>TP13<br>TP27 | F-E, S-D               | Category B<br>SW2       | –                | See entry above.  | 3351     |
| –      | T7                                 | TP2<br>TP28         | F-E, S-D               | Category A<br>SW2       | –                | See entry above.  | 3351     |
| –      | T14                                | TP2<br>TP13<br>TP27 | F-A, S-A               | Category B<br>SW2       | –                | Liquid pesticides which present a very wide range of toxic hazard. Miscibility with water depends upon the composition. Toxic if swallowed, by skin contact or by inhalation.   | 3352     |
| –      | T11                                | TP2<br>TP27         | F-A, S-A               | Category B<br>SW2       | –                | See entry above.  | 3352     |
| –      | T7                                 | TP2<br>TP28         | F-A, S-A               | Category A<br>SW2       | –                | See entry above.  | 3352     |
| –      | –                                  | –                   | F-D, S-U               | Category D              | –                | Flammable mixtures of insecticides with liquefied gases.  | 3354     |
| –      | –                                  | –                   | F-D, S-U               | Category D<br>SW2       | –                | Toxic, flammable mixtures of insecticides with liquefied gases.   | 3355     |
| –      | –                                  | –                   | F-H, S-Q               | Category D              | –                | Oxygen generators, chemical are devices containing chemicals which, upon activation, release oxygen as a product of chemical reaction. Chemical oxygen generators are used for the generation of oxygen for respiratory support, e.g. in aircraft, submarines, spacecraft, bomb shelters and breathing apparatus. Oxidizing salts such as chlorates and perchlorates of lithium, sodium and potassium, which are used in chemical oxygen generators, evolve oxygen when heated. These salts are mixed (compounded) with a fuel, usually iron powder, to form a chlorate candle, which produces oxygen by continuous reaction. The fuel is used to generate heat by oxidation. Once the reaction begins, oxygen is released from the hot salt by thermal decomposition (a thermal shield is used around the generator). A portion of the oxygen reacts with the fuel to produce more heat, which produces more oxygen, and so on. Initiation of the reaction can be achieved by a percussion device, friction device or electric wire. | 3356     |
| –      | –                                  | –                   | F-E, S-Y               | Category D              | –                | –   | △ 3357 △ |



Part 3 – Dangerous Goods List, special provisions and exceptions

Chapter 3.2 – Dangerous Goods List

| UN No. | Proper shipping name (PSN)  | Class or division | Subsidiary hazard(s) | Packing group  | Special provisions      | Limited and excepted quantity provisions |                          | Packing          |                | IBC               |                 |
|--------|---|-------------------|----------------------|----------------|-------------------------|--|--------------------------|------------------|----------------|-------------------|-----------------|
|        |   |                   |                      |                |                         | Limited quantities (7a)                  | Excepted quantities (7b) | Instructions (8) | Provisions (9) | Instructions (10) | Provisions (11) |
| (1)    | (2)<br>3.1.2  | (3)<br>2.0        | (4)<br>2.0           | (5)<br>2.0.1.3 | (6)<br>3.3              | (7a)<br>3.4                              | (7b)<br>3.5              | (8)<br>4.1.4     | (9)<br>4.1.4   | (10)<br>4.1.4     | (11)<br>4.1.4   |
| 3358   | REFRIGERATING MACHINES containing flammable, non-toxic, liquefied gas                       | 2.1               | –                    | –              | 291                     | 0  | E0                       | P003             | PP32           | –                 | –               |
| 3359   | FUMIGATED CARGO TRANSPORT UNIT  | 9                 | –                    | –              | 302                     | 0  | E0                       | –                | –              | –                 | –               |
| 3360   | FIBRES, VEGETABLE, DRY  | 4.1               | –                    | –              | 29<br>123<br>299<br>973 | 0  | E0                       | P003             | PP19           | –                 | –               |
| 3361   | CHLOROSILANES, TOXIC, CORROSIVE, N.O.S.   | 6.1               | 8                    | II             | 274                     | 0  | E0                       | P010             | –              | –                 | –               |
| 3362   | CHLOROSILANES, TOXIC, CORROSIVE, FLAMMABLE, N.O.S.  | 6.1               | 3/8                  | II             | 274                     | 0  | E0                       | P010             | –              | –                 | –               |
| 3363   | DANGEROUS GOODS IN ARTICLES or DANGEROUS GOODS IN MACHINERY or DANGEROUS GOODS IN APPARATUS | 9                 | –                    | –              | 301                     | See SP301                                | E0                       | P907             | –              | –                 | –               |
| 3364   | TRINITROPHENOL (PICRIC ACID), WETTED with not less than 10% water, by mass                  | 4.1               | –                    | I              | 28                      | 0  | E0                       | P406             | PP24<br>PP31   | –                 | –               |
| 3365   | TRINITROCHLOROBENZENE (PICRYL CHLORIDE), WETTED with not less than 10% water, by mass       | 4.1               | –                    | I              | 28                      | 0  | E0                       | P406             | PP24<br>PP31   | –                 | –               |
| 3366   | TRINITROTOLUENE (TNT), WETTED with not less than 10% water, by mass                         | 4.1               | –                    | I              | 28                      | 0  | E0                       | P406             | PP24<br>PP31   | –                 | –               |
| 3367   | TRINITROBENZENE, WETTED with not less than 10% water, by mass                               | 4.1               | –                    | I              | 28                      | 0  | E0                       | P406             | PP24<br>PP31   | –                 | –               |
| 3368   | TRINITROBENZOIC ACID, WETTED with not less than 10% water, by mass                          | 4.1               | –                    | I              | 28                      | 0  | E0                       | P406             | PP24<br>PP31   | –                 | –               |

| UN No. | Portable tanks and bulk containers |                            | EmS                    | Stowage and handling    | Segregation                        | Properties and observations   | UN No. |
|--------|------------------------------------|----------------------------|------------------------|-------------------------|------------------------------------|---|--------|
|        | Tank instructions (12)             | Provisions (14)            |                        |                         |                                    |   |        |
| (12)   | (13)<br>4.2.5<br>4.3               | (14)<br>4.2.5              | (15)<br>5.4.3.4<br>7.8 | (16a)<br>7.1<br>7.3–7.7 | (16b)<br>7.2–7.7                   | (17)  | (18)   |
| –      | –                                  | –                          | F-D, S-U               | Category D              | –                                  | –   | 3358   |
| –      | –                                  | –                          | F-A, S-D               | Category B<br>SW2       | –                                  | A 'FUMIGATED CARGO TRANSPORT UNIT' is a closed cargo transport unit containing goods or materials that either are or have been fumigated within the unit. The fumigant gases used are either poisonous or asphyxiant. The gases are usually evolved from solid or liquid preparations distributed within the unit. See also 5.5.2.  | 3359   |
| –      | –                                  | –                          | F-A, S-I               | Category A              | –                                  | Ignite readily. Consignments of cotton, dry having a density not less than 360 kg/m <sup>3</sup> , flax, dry having a density not less than 400 kg/m <sup>3</sup> , sisal, dry having a density not less than 360 kg/m <sup>3</sup> (ISO Standard 8115 (1986)) and tampico fibre, dry having a density not less than 360 kg/m <sup>3</sup> are not subject to the provisions of this Code when carried in closed cargo transport units. | 3360   |
| –      | T14                                | TP2<br>TP7<br>TP13<br>TP27 | F-A, S-B               | Category C<br>SW2       | SGG1<br>SG36<br>SG49               | Colourless to yellow liquids with a pungent odour. Immiscible with water. React violently with water or steam, evolving hydrogen chloride, an irritating and corrosive gas apparent as white fumes. When involved in a fire, evolve toxic gas. In the presence of moisture, highly corrosive to most metals. Toxic if swallowed, by skin contact or by inhalation. Cause burns to skin, eyes and mucous membranes.                      | 3361   |
| –      | T14                                | TP2<br>TP7<br>TP13<br>TP27 | F-E, S-C               | Category C<br>SW2       | SGG1<br>SG5<br>SG8<br>SG36<br>SG49 | Colourless to yellow flammable liquids with a pungent odour. Immiscible with water. React violently with water or steam, evolving hydrogen chloride, an irritating and corrosive gas apparent as white fumes. When involved in a fire, evolve toxic gas. In the presence of moisture, highly corrosive to most metals. Toxic if swallowed, by skin contact or by inhalation. Cause burns to skin, eyes and mucous membranes.            | 3362   |
| –      | –                                  | –                          | F-A, S-P               | Category A              | –                                  | Types of articles transported under this entry contain only limited quantities of dangerous goods.  | 3363   |
| –      | –                                  | –                          | F-B, S-J               | Category E              | SG7<br>SG30                        | Desensitized explosive. Substance in pure form consists of yellow crystals. Soluble in water. Explosive and sensitive to friction in the dry state. May form extremely sensitive compounds with heavy metals or their salts. Harmful if swallowed or by skin contact.   | 3364   |
| –      | –                                  | –                          | F-B, S-J               | Category E              | SG7<br>SG30                        | Desensitized explosive. Explosive and sensitive to shock and heat in the dry state. Reacts violently with heavy metals and their salts.   | 3365   |
| –      | –                                  | –                          | F-B, S-J               | Category E              | SG7<br>SG30                        | Desensitized explosive. Substance in pure form consists of yellow crystals. When involved in a fire, evolves toxic fumes; in closed compartments, these fumes may form an explosive mixture with air. Explosive and sensitive to shock and heat in the dry state. Reacts violently with heavy metals and their salts.   | 3366   |
| –      | –                                  | –                          | F-B, S-J               | Category E              | SG7<br>SG30                        | Desensitized explosive. Substance in pure form consists of odourless yellow crystals. When involved in a fire, evolves toxic fumes; in closed compartments, these fumes may form an explosive mixture with air. Explosive and sensitive to shock and heat in the dry state. Harmful if swallowed or by skin contact. Reacts violently with heavy metals and their salts.  | 3367   |
| –      | –                                  | –                          | F-B, S-J               | Category E              | SG7<br>SG30                        | Desensitized explosive. Substance in pure form consists of yellow crystals. Soluble in water. When involved in a fire, evolves toxic fumes; in closed compartments, these fumes may form an explosive mixture with air. Explosive and sensitive to shock and heat in the dry state. Harmful if swallowed or by skin contact. Reacts violently with heavy metals and their salts.  | 3368   |

Part 3 – Dangerous Goods List, special provisions and exceptions

Chapter 3.2 – Dangerous Goods List

| UN No. | Proper shipping name (PSN)   | Class or division | Subsidiary hazard(s) | Packing group  | Special provisions | Limited and excepted quantity provisions |                          | Packing          |                | IBC               |                 |
|--------|--|-------------------|----------------------|----------------|--------------------|--|--------------------------|------------------|----------------|-------------------|-----------------|
|        |  |                   |                      |                |                    | Limited quantities (7a)                  | Excepted quantities (7b) | Instructions (8) | Provisions (9) | Instructions (10) | Provisions (11) |
| (1)    | (2)<br>3.1.2   | (3)<br>2.0        | (4)<br>2.0           | (5)<br>2.0.1.3 | (6)<br>3.3         | (7a)<br>3.4                              | (7b)<br>3.5              | (8)<br>4.1.4     | (9)<br>4.1.4   | (10)<br>4.1.4     | (11)<br>4.1.4   |
| 3369   | SODIUM DINITRO- <i>o</i> -CRESOLATE, WETTED with not less than 10% water, by mass    | 4.1               | 6.1<br>P             | I              | 28                 | 0  | E0                       | P406             | PP24<br>PP31   | -                 | -               |
| 3370   | UREA NITRATE, WETTED with not less than 10% water, by mass                           | 4.1               | -                    | I              | 28                 | 0  | E0                       | P406             | PP31<br>PP78   | -                 | -               |
| 3371   | 2-METHYLBUTANAL  | 3                 | -                    | II             | -                  | 1 L                                      | E2                       | P001             | -              | IBC02             | -               |
| 3373   | BIOLOGICAL SUBSTANCE, CATEGORY B   | 6.2               | -                    | -              | 319<br>341         | 0  | E0                       | P650             | -              | -                 | -               |
| 3374   | ACETYLENE, SOLVENT FREE  | 2.1               | -                    | -              | -                  | 0  | E0                       | P200             | -              | -                 | -               |
| 3375   | AMMONIUM NITRATE EMULSION or SUSPENSION or GEL, intermediate for blasting explosives | 5.1               | -                    | II             | 309                | 0  | E2                       | P505             | -              | IBC02             | B16             |
| 3376   | 4-NITROPHENYLHYDRAZINE, with not less than 30% water, by mass                        | 4.1               | -                    | I              | 28                 | 0  | E0                       | P406             | PP26<br>PP31   | -                 | -               |
| 3377   | SODIUM PERBORATE MONOHYDRATE   | 5.1               | -                    | III            | 967                | 5 kg                                     | E1                       | P002<br>LP02     | -              | IBC08             | B3              |
| 3378   | SODIUM CARBONATE PEROXYHYDRATE   | 5.1               | -                    | II             | -                  | 1 kg                                     | E2                       | P002             | -              | IBC08             | B4<br>B21       |
| 3378   | SODIUM CARBONATE PEROXYHYDRATE   | 5.1               | -                    | III            | 967                | 5 kg                                     | E1                       | P002<br>LP02     | -              | IBC08             | B3              |
| 3379   | DESENSITIZED EXPLOSIVE, LIQUID, N.O.S.   | 3                 | -                    | I              | 274<br>311         | 0  | E0                       | P099             | -              | -                 | -               |

| UN No. | Portable tanks and bulk containers |                            | EmS                    | Stowage and handling            | Segregation  | Properties and observations   | UN No. |
|--------|------------------------------------|----------------------------|------------------------|---------------------------------|--|---|--------|
|        | Tank instructions (12)             | Provisions (14)            |                        |                                 |  |   |        |
| (1)    | (13)<br>4.2.5<br>4.3               | (14)<br>4.2.5              | (15)<br>5.4.3.4<br>7.8 | (16a)<br>7.1<br>7.3-7.7         | (16b)<br>7.2-7.7   | (17)  | (18)   |
| 3369   | -                                  | -                          | F-B, S-J               | Category E                      | SG7<br>SG30  | Desensitized explosive. Substance in pure form consists of yellow powder. May form extremely sensitive compounds with heavy metals or their salts. When involved in a fire, evolves toxic fumes; in closed compartments, these fumes may form an explosive mixture with air. Explosive and sensitive to friction in the dry state. Toxic if swallowed, by skin contact or by inhalation.  | 3369   |
| 3370   | -                                  | -                          | F-B, S-J               | Category E                      | SG7<br>SG30  | Desensitized explosive. May form extremely sensitive compounds with heavy metals or their salts. Explosive and sensitive to friction in the dry state. Harmful if swallowed or by skin contact.   | 3370   |
| 3371   | T4                                 | TP1                        | F-E, S-D               | Category B                      | -  | Colourless liquid. Flashpoint: -3.5°C. Explosive limits: 1.3 to 13.9%. Slightly miscible with water.  | 3371   |
| 3373   | T1<br>BK2                          | TP1                        | F-A, S-T               | Category C<br>SW2<br>SW18       | -  | Substances which are known or are reasonably expected to contain pathogens, transported in a form that, when exposure to it occurs, are not capable of causing permanent disability, life-threatening or fatal disease to humans or animals. Human or animal specimens for which there is minimal likelihood that pathogens are present are not subject to the provisions of this Code (see 2.6.3.2.3.6). Other exemptions are stated in 2.6.3.2.3. | 3373   |
| 3374   | -                                  | -                          | F-D, S-U               | Category D<br>SW1<br>SW2        | SG46   | Flammable gas with slight odour. Explosive limits: 2.1 to 80%. Lighter than air (0.907). Acetylene without solvent. Rough handling and exposure to local heating should be avoided, since these conditions may result in delayed explosion. Empty cylinders should be carried with the same precautions as filled cylinders.  | 3374   |
| 3375   | T1                                 | TP1<br>TP9<br>TP17<br>TP32 | F-H, S-Q               | Category D<br>SW1               | SGG2<br>SG16<br>SG42<br>SG45<br>SG47<br>SG48<br>SG51<br>SG56<br>SG58<br>SG59<br>SG61 | Non-sensitized emulsions, suspensions and gels consisting primarily of a mixture of ammonium nitrate and fuel, intended to produce a Type E blasting explosive only after further processing prior to use. Substances shall satisfactorily pass test series 8 of the <i>Manual of Tests and Criteria</i> , part I, section 18 and be approved by the competent authority.   | 3375   |
| 3376   | -                                  | -                          | F-B, S-J               | Category E                      | SG7<br>SG30  | Desensitized explosive. Dark orange solid. Explosive and sensitive to friction in the dry state. May form extremely sensitive compounds with heavy metals or their salts. Harmful if swallowed or by skin contact.  | 3376   |
| 3377   | T1<br>BK2<br>BK3                   | TP33                       | F-A, S-Q               | Category A<br>SW1<br>SW23<br>H1 | SGG16<br>SG59  | White crystals or powder. Partially soluble in water. Mixtures with combustible material are readily ignited and may burn fiercely. Risk of decomposition when exposed to continuous heat (exothermic decomposition ≥ 60°C). When involved in a fire or exposed to high temperatures, it may decompose, yielding oxygen and steam. Harmful if swallowed.  | 3377   |
| 3378   | T3<br>BK2                          | TP33                       | F-A, S-Q               | Category A<br>SW1<br>H1         | SGG16<br>SG59  | White crystals or powder. Soluble in water. Mixtures with combustible material are readily ignited. Decomposes in contact with water and acids, forming hydrogen peroxide. Risk of decomposition when exposed to continuous heat (exothermic decomposition ≥ 60°C). When involved in a fire or exposed to high temperatures, it may decompose, yielding oxygen and steam. Irritating to eyes, skin and mucous membranes. Harmful if swallowed.      | 3378   |
| 3378   | T1<br>BK2<br>BK3                   | TP33                       | F-A, S-Q               | Category A<br>SW1<br>SW23<br>H1 | SGG16<br>SG59  | See entry above.  | 3378   |
| 3379   | -                                  | -                          | F-E, S-Y               | Category D                      | SG30   | Desensitized explosive. Explosive and sensitive to friction in the dry state. May form extremely sensitive compounds with heavy metals and their salts.   | 3379   |



Part 3 – Dangerous Goods List, special provisions and exceptions

Chapter 3.2 – Dangerous Goods List

| UN No. | Proper shipping name (PSN)  | Class or division | Subsidiary hazard(s) | Packing group  | Special provisions | Limited and excepted quantity provisions |                     | Packing      |              | IBC           |               |
|--------|---|-------------------|----------------------|----------------|--------------------|--|---------------------|--------------|--------------|---------------|---------------|
|        |   |                   |                      |                |                    | Limited quantities                       | Excepted quantities | Instructions | Provisions   | Instructions  | Provisions    |
| (1)    | (2)<br>3.1.2  | (3)<br>2.0        | (4)<br>2.0           | (5)<br>2.0.1.3 | (6)<br>3.3         | (7a)<br>3.4                              | (7b)<br>3.5         | (8)<br>4.1.4 | (9)<br>4.1.4 | (10)<br>4.1.4 | (11)<br>4.1.4 |
| 3380   | DESENSITIZED EXPLOSIVE, SOLID, N.O.S.   | 4.1               | –                    | I              | 274<br>311<br>394  | 0  | E0                  | P099         | –            | –             | –             |
| 3381   | TOXIC BY INHALATION LIQUID, N.O.S. with an LC <sub>50</sub> lower than or equal to 200 mL/m <sup>3</sup> and saturated vapour concentration greater than or equal to 500 LC <sub>50</sub>                 | 6.1               | –                    | I              | 274                | 0  | E0                  | P601         | –            | –             | –             |
| 3382   | TOXIC BY INHALATION LIQUID, N.O.S. with an LC <sub>50</sub> lower than or equal to 1000 mL/m <sup>3</sup> and saturated vapour concentration greater than or equal to 10 LC <sub>50</sub>                 | 6.1               | –                    | I              | 274                | 0  | E0                  | P602         | –            | –             | –             |
| 3383   | TOXIC BY INHALATION LIQUID, FLAMMABLE, N.O.S. with an LC <sub>50</sub> lower than or equal to 200 mL/m <sup>3</sup> and saturated vapour concentration greater than or equal to 500 LC <sub>50</sub>      | 6.1               | 3                    | I              | 274                | 0  | E0                  | P601         | –            | –             | –             |
| 3384   | TOXIC BY INHALATION LIQUID, FLAMMABLE, N.O.S. with an LC <sub>50</sub> lower than or equal to 1000 mL/m <sup>3</sup> and saturated vapour concentration greater than or equal to 10 LC <sub>50</sub>      | 6.1               | 3                    | I              | 274                | 0  | E0                  | P602         | –            | –             | –             |
| 3385   | TOXIC BY INHALATION LIQUID, WATER-REACTIVE, N.O.S. with an LC <sub>50</sub> lower than or equal to 200 mL/m <sup>3</sup> and saturated vapour concentration greater than or equal to 500 LC <sub>50</sub> | 6.1               | 4.3                  | I              | 274                | 0  | E0                  | P601         | –            | –             | –             |
| 3386   | TOXIC BY INHALATION LIQUID, WATER-REACTIVE, N.O.S. with an LC <sub>50</sub> lower than or equal to 1000 mL/m <sup>3</sup> and saturated vapour concentration greater than or equal to 10 LC <sub>50</sub> | 6.1               | 4.3                  | I              | 274                | 0  | E0                  | P602         | –            | –             | –             |
| 3387   | TOXIC BY INHALATION LIQUID, OXIDIZING, N.O.S. with an LC <sub>50</sub> lower than or equal to 200 mL/m <sup>3</sup> and saturated vapour concentration greater than or equal to 500 LC <sub>50</sub>      | 6.1               | 5.1                  | I              | 274                | 0  | E0                  | P601         | –            | –             | –             |
| 3388   | TOXIC BY INHALATION LIQUID, OXIDIZING, N.O.S. with an LC <sub>50</sub> lower than or equal to 1000 mL/m <sup>3</sup> and saturated vapour concentration greater than or equal to 10 LC <sub>50</sub>      | 6.1               | 5.1                  | I              | 274                | 0  | E0                  | P602         | –            | –             | –             |
| 3389   | TOXIC BY INHALATION LIQUID, CORROSIVE, N.O.S. with an LC <sub>50</sub> lower than or equal to 200 mL/m <sup>3</sup> and saturated vapour concentration greater than or equal to 500 LC <sub>50</sub>      | 6.1               | 8                    | I              | 274                | 0  | E0                  | P601         | –            | –             | –             |

| UN No. | Portable tanks and bulk containers |               | EmS                    | Stowage and handling    | Segregation      | Properties and observations   | UN No. |
|--------|------------------------------------|---------------|------------------------|-------------------------|------------------|---|--------|
|        | Tank instructions                  | Provisions    |                        |                         |                  |   |        |
| (12)   | (13)<br>4.2.5<br>4.3               | (14)<br>4.2.5 | (15)<br>5.4.3.4<br>7.8 | (16a)<br>7.1<br>7.3–7.7 | (16b)<br>7.2–7.7 | (17)  | (18)   |
| –      | –                                  | –             | F-B, S-J               | Category D              | SG7<br>SG30      | Desensitized explosive. Explosive and sensitive to friction in the dry state. May form extremely sensitive compounds with heavy metals and their salts.                 | 3380   |
| –      | T22                                | TP2<br>TP13   | F-A, S-A               | Category D<br>SW2       | –                | A variety of toxic liquids which present a highly toxic inhalation hazard. Highly toxic if swallowed, by skin contact or by inhalation.                                 | 3381   |
| –      | T20                                | TP2<br>TP13   | F-A, S-A               | Category D<br>SW2       | –                | A variety of toxic liquids which present a highly toxic inhalation hazard. Highly toxic if swallowed, by skin contact or by inhalation.                                 | 3382   |
| –      | T22                                | TP2<br>TP13   | F-E, S-D               | Category D<br>SW2       | –                | A variety of toxic liquids which present a highly toxic inhalation hazard as well as being flammable. Highly toxic if swallowed, by skin contact or by inhalation.      | 3383   |
| –      | T20                                | TP2<br>TP13   | F-E, S-D               | Category D<br>SW2       | –                | A variety of toxic liquids which present a highly toxic inhalation hazard as well as being flammable. Highly toxic if swallowed, by skin contact or by inhalation.      | 3384   |
| –      | T22                                | TP2<br>TP13   | F-G, S-N               | Category D<br>SW2<br>H1 | SG26             | A variety of toxic liquids which present a highly toxic inhalation hazard as well as being water-reactive. Highly toxic if swallowed, by skin contact or by inhalation. | 3385   |
| –      | T20                                | TP2<br>TP13   | F-G, S-N               | Category D<br>SW2<br>H1 | SG26             | A variety of toxic liquids which present a highly toxic inhalation hazard as well as being water-reactive. Highly toxic if swallowed, by skin contact or by inhalation. | 3386   |
| –      | T22                                | TP2<br>TP13   | F-A, S-Q               | Category D<br>SW2       | –                | A variety of toxic liquids which present a highly toxic inhalation hazard as well as being an oxidizer. Highly toxic if swallowed, by skin contact or by inhalation.    | 3387   |
| –      | T20                                | TP2<br>TP13   | F-A, S-Q               | Category D<br>SW2       | –                | A variety of toxic liquids which present a highly toxic inhalation hazard as well as being an oxidizer. Highly toxic if swallowed, by skin contact or by inhalation.    | 3388   |
| –      | T22                                | TP2<br>TP13   | F-A, S-B               | Category D<br>SW2       | –                | A variety of toxic liquids which present a highly toxic inhalation hazard as well as being corrosive. Highly toxic if swallowed, by skin contact or by inhalation.      | 3389   |

Part 3 – Dangerous Goods List, special provisions and exceptions

Chapter 3.2 – Dangerous Goods List

| UN No. | Proper shipping name (PSN)   | Class or division | Subsidiary hazard(s) | Packing group  | Special provisions | Limited and excepted quantity provisions |                     | Packing      |              | IBC           |               |
|--------|--|-------------------|----------------------|----------------|--------------------|--|---------------------|--------------|--------------|---------------|---------------|
|        |  |                   |                      |                |                    | Limited quantities                       | Excepted quantities | Instructions | Provisions   | Instructions  | Provisions    |
| (1)    | (2)<br>3.1.2   | (3)<br>2.0        | (4)<br>2.0           | (5)<br>2.0.1.3 | (6)<br>3.3         | (7a)<br>3.4                              | (7b)<br>3.5         | (8)<br>4.1.4 | (9)<br>4.1.4 | (10)<br>4.1.4 | (11)<br>4.1.4 |
| 3390   | TOXIC BY INHALATION LIQUID, CORROSIVE, N.O.S. with an LC <sub>50</sub> lower than or equal to 1000 mL/m <sup>3</sup> and saturated vapour concentration greater than or equal to 10 LC <sub>50</sub> | 6.1               | 8                    | I              | 274                | 0  | E0                  | P602         | -            | -             | -             |
| 3391   | ORGANOMETALLIC SUBSTANCE, SOLID, PYROPHORIC  | 4.2               | -                    | I              | 274                | 0  | E0                  | P404         | PP86         | -             | -             |
| 3392   | ORGANOMETALLIC SUBSTANCE, LIQUID, PYROPHORIC   | 4.2               | -                    | I              | 274                | 0  | E0                  | P400         | PP86         | -             | -             |
| 3393   | ORGANOMETALLIC SUBSTANCE, SOLID, PYROPHORIC, WATER-REACTIVE  | 4.2               | 4.3                  | I              | 274                | 0  | E0                  | P404         | PP86         | -             | -             |
| 3394   | ORGANOMETALLIC SUBSTANCE, LIQUID, PYROPHORIC, WATER-REACTIVE   | 4.2               | 4.3                  | I              | 274                | 0  | E0                  | P400         | PP86         | -             | -             |
| 3395   | ORGANOMETALLIC SUBSTANCE, SOLID, WATER-REACTIVE  | 4.3               | -                    | I              | 274                | 0  | E0                  | P403         | PP31         | -             | -             |
| 3395   | ORGANOMETALLIC SUBSTANCE, SOLID, WATER-REACTIVE  | 4.3               | -                    | II             | 274                | 500 g                                    | E2                  | P410         | PP31         | IBC04         | -             |
| 3395   | ORGANOMETALLIC SUBSTANCE, SOLID, WATER-REACTIVE  | 4.3               | -                    | III            | 223<br>274         | 1 kg                                     | E1                  | P410         | PP31         | IBC06         | -             |
| 3396   | ORGANOMETALLIC SUBSTANCE, SOLID, WATER-REACTIVE, FLAMMABLE   | 4.3               | 4.1                  | I              | 274                | 0  | E0                  | P403         | PP31         | -             | -             |
| 3396   | ORGANOMETALLIC SUBSTANCE, SOLID, WATER-REACTIVE, FLAMMABLE   | 4.3               | 4.1                  | II             | 274                | 500 g                                    | E2                  | P410         | PP31         | IBC04         | -             |
| 3396   | ORGANOMETALLIC SUBSTANCE, SOLID, WATER-REACTIVE, FLAMMABLE   | 4.3               | 4.1                  | III            | 223<br>274         | 1 kg                                     | E1                  | P410         | PP31         | IBC06         | -             |
| 3397   | ORGANOMETALLIC SUBSTANCE, SOLID, WATER-REACTIVE, SELF-HEATING  | 4.3               | 4.2                  | I              | 274                | 0  | E0                  | P403         | PP31         | -             | -             |
| 3397   | ORGANOMETALLIC SUBSTANCE, SOLID, WATER-REACTIVE, SELF-HEATING  | 4.3               | 4.2                  | II             | 274                | 500 g                                    | E2                  | P410         | PP31         | IBC04         | -             |
| 3397   | ORGANOMETALLIC SUBSTANCE, SOLID, WATER-REACTIVE, SELF-HEATING  | 4.3               | 4.2                  | III            | 223<br>274         | 1 kg                                     | E1                  | P410         | PP31         | IBC06         | -             |
| 3398   | ORGANOMETALLIC SUBSTANCE, LIQUID, WATER-REACTIVE   | 4.3               | -                    | I              | 274                | 0  | E0                  | P402         | PP31         | -             | -             |

| UN No. | Portable tanks and bulk containers |                             | EmS                    | Stowage and handling    | Segregation                  | Properties and observations  | UN No. |
|--------|------------------------------------|-----------------------------|------------------------|-------------------------|------------------------------|--|--------|
|        | Tank instructions                  | Provisions                  |                        |                         |                              |  |        |
| (12)   | (13)<br>4.2.5<br>4.3               | (14)<br>4.2.5               | (15)<br>5.4.3.4<br>7.8 | (16a)<br>7.1<br>7.3-7.7 | (16b)<br>7.2-7.7             | (17)   | (18)   |
| -      | T20                                | TP2<br>TP13                 | F-A, S-B               | Category D<br>SW2       | -                            | A variety of toxic liquids which present a highly toxic inhalation hazard as well as being corrosive. Highly toxic if swallowed, by skin contact or by inhalation.                                       | 3390   |
| -      | T21                                | TP7<br>TP33<br>TP36         | F-G, S-M               | Category D<br>H1        | SG26<br>SG72                 | Liable to ignite spontaneously in air. If shaken, may produce sparks.  | 3391   |
| -      | T21                                | TP2<br>TP7<br>TP36          | F-G, S-M               | Category D<br>H1        | SG26<br>SG63<br>SG72         | Highly flammable liquid. Liable to ignite spontaneously in air. In contact with air, evolve irritating and slightly toxic fumes.   | 3392   |
| -      | T21                                | TP7<br>TP33<br>TP36<br>TP41 | F-G, S-M               | Category D<br>H1        | SG26<br>SG35<br>SG72         | Liable to ignite spontaneously in air. If shaken, may produce sparks. React violently with moisture, water and acids, evolving flammable gas.  | 3393   |
| -      | T21                                | TP2<br>TP7<br>TP36<br>TP41  | F-G, S-M               | Category D<br>H1        | SG26<br>SG35<br>SG63<br>SG72 | Highly flammable liquid. Liable to ignite spontaneously in air. In contact with air, evolve irritating and slightly toxic fumes. React violently with moisture, water and acids, evolving flammable gas. | 3394   |
| -      | T9                                 | TP7<br>TP33<br>TP36<br>TP41 | F-G, S-N               | Category E<br>SW2<br>H1 | SG26<br>SG35<br>SG72         | Reacts violently with moisture, water and acids, evolving flammable gas.   | 3395   |
| -      | T3                                 | TP33<br>TP36<br>TP41        | F-G, S-N               | Category E<br>SW2<br>H1 | SG26<br>SG35<br>SG72         | See entry above.   | 3395   |
| -      | T1                                 | TP33<br>TP36<br>TP41        | F-G, S-N               | Category E<br>SW2<br>H1 | SG26<br>SG35<br>SG72         | See entry above.   | 3395   |
| -      | T9                                 | TP7<br>TP33<br>TP36<br>TP41 | F-G, S-N               | Category E<br>SW2<br>H1 | SG26<br>SG35<br>SG72         | Flammable solid. Reacts violently with moisture, water and acids, evolving flammable gas.  | 3396   |
| -      | T3                                 | TP33<br>TP36<br>TP41        | F-G, S-N               | Category E<br>SW2<br>H1 | SG26<br>SG35<br>SG72         | See entry above.   | 3396   |
| -      | T1                                 | TP33<br>TP36<br>TP41        | F-G, S-N               | Category E<br>SW2<br>H1 | SG26<br>SG35<br>SG72         | See entry above.   | 3396   |
| -      | T9                                 | TP7<br>TP33<br>TP36<br>TP41 | F-G, S-N               | Category E<br>SW2<br>H1 | SG26<br>SG35<br>SG72         | Liable to self-heating or spontaneous combustion. Reacts violently with moisture, water and acids, evolving flammable gas.   | 3397   |
| -      | T3                                 | TP33<br>TP36<br>TP41        | F-G, S-N               | Category E<br>SW2<br>H1 | SG26<br>SG35<br>SG72         | See entry above.   | 3397   |
| -      | T1                                 | TP33<br>TP36<br>TP41        | F-G, S-N               | Category E<br>SW2<br>H1 | SG26<br>SG35<br>SG72         | See entry above.   | 3397   |
| -      | T13                                | TP2<br>TP7<br>TP36<br>TP41  | F-G, S-N               | Category E<br>SW2<br>H1 | SG26<br>SG35<br>SG72         | Reacts violently with moisture, water and acids, evolving flammable gas.   | 3398   |

Part 3 – Dangerous Goods List, special provisions and exceptions

Chapter 3.2 – Dangerous Goods List

| UN No. | Proper shipping name (PSN)                                  | Class or division | Subsidiary hazard(s) | Packing group  | Special provisions | Limited and excepted quantity provisions |                     | Packing      |              | IBC           |               |
|--------|---|-------------------|----------------------|----------------|--------------------|--|---------------------|--------------|--------------|---------------|---------------|
|        |   |                   |                      |                |                    | Limited quantities                       | Excepted quantities | Instructions | Provisions   | Instructions  | Provisions    |
| (1)    | (2)<br>3.1.2  | (3)<br>2.0        | (4)<br>2.0           | (5)<br>2.0.1.3 | (6)<br>3.3         | (7a)<br>3.4                              | (7b)<br>3.5         | (8)<br>4.1.4 | (9)<br>4.1.4 | (10)<br>4.1.4 | (11)<br>4.1.4 |
| 3398   | ORGANOMETALLIC SUBSTANCE, LIQUID, WATER-REACTIVE            | 4.3               | –                    | II             | 274                | 500 mL                                   | E2                  | P001         | PP31         | IBC01         | –             |
| 3398   | ORGANOMETALLIC SUBSTANCE, LIQUID, WATER-REACTIVE            | 4.3               | –                    | III            | 223<br>274         | 1 L                                      | E1                  | P001         | PP31         | IBC02         | –             |
| 3399   | ORGANOMETALLIC SUBSTANCE, LIQUID, WATER-REACTIVE, FLAMMABLE | 4.3               | 3                    | I              | 274                | 0  | E0                  | P402         | PP31         | –             | –             |
| 3399   | ORGANOMETALLIC SUBSTANCE, LIQUID, WATER-REACTIVE, FLAMMABLE | 4.3               | 3                    | II             | 274                | 500 mL                                   | E2                  | P001         | PP31         | IBC01         | –             |
| 3399   | ORGANOMETALLIC SUBSTANCE, LIQUID, WATER-REACTIVE, FLAMMABLE | 4.3               | 3                    | III            | 223<br>274         | 1 L                                      | E1                  | P001         | PP31         | IBC02         | –             |
| 3400   | ORGANOMETALLIC SUBSTANCE, SOLID, SELF-HEATING               | 4.2               | –                    | II             | 274                | 500 g                                    | E2                  | P410         | –            | IBC06         | –             |
| 3400   | ORGANOMETALLIC SUBSTANCE, SOLID, SELF-HEATING               | 4.2               | –                    | III            | 223<br>274         | 1 kg                                     | E1                  | P002         | –            | IBC08         | –             |
| 3401   | ALKALI METAL AMALGAM, SOLID                                 | 4.3               | –                    | I              | 182                | 0  | E0                  | P403         | PP31         | –             | –             |
| 3402   | ALKALINE EARTH METAL AMALGAM, SOLID                         | 4.3               | –                    | I              | 183                | 0  | E0                  | P403         | PP31         | –             | –             |
| 3403   | POTASSIUM METAL ALLOYS, SOLID                               | 4.3               | –                    | I              | –                  | 0  | E0                  | P403         | PP31         | –             | –             |
| 3404   | POTASSIUM SODIUM ALLOYS, SOLID                              | 4.3               | –                    | I              | –                  | 0  | E0                  | P403         | PP31         | –             | –             |
| 3405   | BARIUM CHLORATE SOLUTION                                    | 5.1               | 6.1                  | II             | –                  | 1 L                                      | E2                  | P504         | –            | IBC02         | –             |
| 3405   | BARIUM CHLORATE SOLUTION                                    | 5.1               | 6.1                  | III            | 223                | 5 L                                      | E1                  | P001         | –            | IBC02         | –             |

| UN No. | Portable tanks and bulk containers |                            | EmS                    | Stowage and handling    | Segregation                   | Properties and observations  | UN No. |
|--------|------------------------------------|----------------------------|------------------------|-------------------------|-------------------------------|--|--------|
|        | Tank instructions                  | Provisions                 |                        |                         |                               |  |        |
| (12)   | (13)<br>4.2.5<br>4.3               | (14)<br>4.2.5              | (15)<br>5.4.3.4<br>7.8 | (16a)<br>7.1<br>7.3–7.7 | (16b)<br>7.2–7.7              | (17)   | (18)   |
| –      | T7                                 | TP2<br>TP7<br>TP36<br>TP41 | F-G, S-N               | Category E<br>SW2<br>H1 | SG26<br>SG35<br>SG72          | Reacts violently with moisture, water and acids, evolving flammable gas.   | 3398   |
| –      | T7                                 | TP2<br>TP7<br>TP36<br>TP41 | F-G, S-N               | Category E<br>SW2<br>H1 | SG26<br>SG35<br>SG72          | See entry above.   | 3398   |
| –      | T13                                | TP2<br>TP7<br>TP36<br>TP41 | F-G, S-N               | Category D<br>SW2<br>H1 | SG26<br>SG35<br>SG72          | Flammable liquid. Reacts violently with moisture, water and acids, evolving flammable gas.   | 3399   |
| –      | T7                                 | TP2<br>TP7<br>TP36<br>TP41 | F-G, S-N               | Category D<br>SW2<br>H1 | SG26<br>SG35<br>SG72          | See entry above.   | 3399   |
| –      | T7                                 | TP2<br>TP7<br>TP36<br>TP41 | F-G, S-N               | Category E<br>SW2<br>H1 | SG26<br>SG35<br>SG72          | See entry above.   | 3399   |
| –      | T3                                 | TP33<br>TP36               | F-A, S-J               | Category C              | SG72                          | Liable to self-heating or spontaneous combustion.  | 3400   |
| –      | T1                                 | TP33<br>TP36               | F-A, S-J               | Category C              | SG72                          | See entry above.   | 3400   |
| –      | T9                                 | TP7<br>TP33                | F-G, S-N               | Category D<br>H1        | SGG7<br>SGG11<br>SG26<br>SG35 | Silvery solid, consisting of metal alloyed with mercury. Reacts with moisture, water or acids, evolving hydrogen, a flammable gas. When heated, evolves toxic vapours.   | 3401   |
| –      | T9                                 | TP7<br>TP33                | F-G, S-N               | Category D<br>H1        | SGG7<br>SGG11<br>SG26<br>SG35 | Consists of metal alloyed with mercury. Contains 2% to 10% alkaline earth metals and may contain up to 98% mercury. Reacts with moisture, water or acids, evolving hydrogen, a flammable gas. When heated, evolves toxic vapours.  | 3402   |
| –      | T9                                 | TP7<br>TP33                | F-G, S-L               | Category D<br>H1        | SG26<br>SG35                  | Soft, silvery metal. Floats on water. Reacts violently with moisture, water or acids, evolving hydrogen, which may be ignited by the heat of the reaction. Highly reactive, sometimes with explosive effect.   | 3403   |
| –      | T9                                 | TP7<br>TP33                | F-G, S-L               | Category D<br>H1        | SG26<br>SG35                  | Soft, silvery metal. Floats on water. Reacts violently with moisture, water or acids, evolving hydrogen, which may be ignited by the heat of the reaction. Highly reactive, sometimes with explosive effect.   | 3404   |
| –      | T4                                 | TP1                        | F-H, S-Q               | Category A              | SGG4<br>SG38<br>SG49<br>SG62  | Colourless aqueous solution. Reacts vigorously with sulphuric acid. Reacts fiercely with cyanides when heated. May form explosive mixtures with combustible material, powdered metals or ammonium compounds. These mixtures are liable to ignite. When involved in a fire, may cause an explosion. Toxic if swallowed, by skin contact or by inhalation. Leakage and subsequent evaporation of the water from the solutions may present increased dangers as follows:<br>.1 in contact with combustible material (particularly fibrous material such as jute, cotton or sisal) or sulphur, danger of spontaneous combustion,<br>.2 in contact with ammonium compounds, powdered metals or oils, danger of explosion. | 3405   |
| –      | T4                                 | TP1                        | F-H, S-Q               | Category A              | SGG4<br>SG38<br>SG49<br>SG62  | See entry above.   | 3405   |

Part 3 – Dangerous Goods List, special provisions and exceptions

Chapter 3.2 – Dangerous Goods List

| UN No. | Proper shipping name (PSN)  | Class or division | Subsidiary hazard(s) | Packing group  | Special provisions | Limited and excepted quantity provisions |                     | Packing      |              | IBC           |               |
|--------|---|-------------------|----------------------|----------------|--------------------|--|---------------------|--------------|--------------|---------------|---------------|
|        |   |                   |                      |                |                    | Limited quantities                       | Excepted quantities | Instructions | Provisions   | Instructions  | Provisions    |
| (1)    | (2)<br>3.1.2  | (3)<br>2.0        | (4)<br>2.0           | (5)<br>2.0.1.3 | (6)<br>3.3         | (7a)<br>3.4                              | (7b)<br>3.5         | (8)<br>4.1.4 | (9)<br>4.1.4 | (10)<br>4.1.4 | (11)<br>4.1.4 |
| 3406   | BARIUM PERCHLORATE SOLUTION   | 5.1               | 6.1                  | II             | –                  | 1 L                                      | E2                  | P504         | –            | IBC02         | –             |
| 3406   | BARIUM PERCHLORATE SOLUTION   | 5.1               | 6.1                  | III            | 223                | 5 L                                      | E1                  | P001         | –            | IBC02         | –             |
| 3407   | CHLORATE AND MAGNESIUM CHLORIDE MIXTURE SOLUTION                      | 5.1               | –                    | II             | –                  | 1 L                                      | E2                  | P504         | –            | IBC02         | –             |
| 3407   | CHLORATE AND MAGNESIUM CHLORIDE MIXTURE SOLUTION                      | 5.1               | –                    | III            | 223                | 5 L                                      | E1                  | P504         | –            | IBC02         | –             |
| 3408   | LEAD PERCHLORATE SOLUTION   | 5.1               | 6.1<br>P             | II             | –                  | 1 L                                      | E2                  | P504         | –            | IBC02         | –             |
| 3408   | LEAD PERCHLORATE SOLUTION   | 5.1               | 6.1<br>P             | III            | 223                | 5 L                                      | E1                  | P001         | –            | IBC02         | –             |
| 3409   | CHLORONITROBENZENES, LIQUID   | 6.1               | –                    | II             | 279                | 100 mL                                   | E4                  | P001         | –            | IBC02         | –             |
| 3410   | 4-CHLORO- <i>o</i> -TOLUIDINE HYDROCHLORIDE SOLUTION                  | 6.1               | –                    | III            | 223                | 5 L                                      | E1                  | P001         | –            | IBC03         | –             |
| 3411   | <i>beta</i> -NAPHTHYLAMINE SOLUTION                                   | 6.1               | –                    | II             | –                  | 100 mL                                   | E4                  | P001         | –            | IBC02         | –             |
| 3411   | <i>beta</i> -NAPHTHYLAMINE SOLUTION                                   | 6.1               | –                    | III            | 223                | 5 L                                      | E1                  | P001         | –            | IBC02         | –             |
| 3412   | FORMIC ACID with not less than 10% but not more than 85% acid by mass | 8                 | –                    | II             | –                  | 1 L                                      | E2                  | P001         | –            | IBC02         | –             |
| 3412   | FORMIC ACID with not less than 5% but less than 10% acid by mass      | 8                 | –                    | III            | –                  | 5 L                                      | E1                  | P001<br>LP01 | –            | IBC03         | –             |
| 3413   | POTASSIUM CYANIDE SOLUTION  | 6.1               | –<br>P               | I              | –                  | 0  | E5                  | P001         | PP31         | –             | –             |

| UN No. | Portable tanks and bulk containers |               | EmS                    | Stowage and handling    | Segregation                           | Properties and observations   | UN No. |
|--------|------------------------------------|---------------|------------------------|-------------------------|---------------------------------------|---|--------|
|        | Tank instructions                  | Provisions    |                        |                         |                                       |   |        |
| (12)   | (13)<br>4.2.5<br>4.3               | (14)<br>4.2.5 | (15)<br>5.4.3.4<br>7.8 | (16a)<br>7.1<br>7.3–7.7 | (16b)<br>7.2–7.7                      | (17)  | (18)   |
| –      | T4                                 | TP1           | F-H, S-Q               | Category A              | SGG13<br>SG38<br>SG49<br>SG62         | Reacts vigorously with sulphuric acid. Reacts fiercely with cyanides when heated. May form explosive mixtures with combustible material, powdered metals or ammonium compounds. These mixtures are liable to ignite. When involved in a fire, may cause an explosion. Toxic if swallowed, by skin contact or by inhalation. Leakage and subsequent evaporation of the water from the solutions may present increased dangers as follows:<br>.1 in contact with combustible material (particularly fibrous material such as jute, cotton or sisal) or sulphur, danger of spontaneous combustion,<br>.2 in contact with ammonium compounds, powdered metals or oils, danger of explosion. | 3406   |
| –      | T4                                 | TP1           | F-H, S-Q               | Category A              | SGG13<br>SG38<br>SG49<br>SG62         | See entry above.  | 3406   |
| –      | T4                                 | TP1           | F-H, S-Q               | Category A              | SGG4<br>SG38<br>SG49<br>SG62          | Reacts vigorously with sulphuric acid. Reacts fiercely with cyanides when heated. May form explosive mixtures with combustible material, powdered metals or ammonium compounds. These mixtures are liable to ignite. When involved in a fire, may cause an explosion. Leakage and subsequent evaporation of the water from the solutions may present increased dangers as follows:<br>.1 in contact with combustible material (particularly fibrous material such as jute, cotton or sisal) or sulphur, danger of spontaneous combustion,<br>.2 in contact with ammonium compounds, powdered metals or oils, danger of explosion.   | 3407   |
| –      | T4                                 | TP1           | F-H, S-Q               | Category A              | SGG4<br>SG38<br>SG49<br>SG62          | See entry above.  | 3407   |
| –      | T4                                 | TP1           | F-H, S-Q               | Category A              | SGG7<br>SGG9<br>SGG13<br>SG38<br>SG49 | Reacts vigorously with sulphuric acid. Reacts fiercely with cyanides when heated. May form explosive mixtures with combustible material, powdered metals or ammonium compounds. These mixtures are liable to ignite. When involved in a fire, may cause an explosion.   | 3408   |
| –      | T4                                 | TP1           | F-H, S-Q               | Category A              | SGG7<br>SGG9<br>SGG13<br>SG38<br>SG49 | See entry above.  | 3408   |
| –      | T7                                 | TP2           | F-A, S-A               | Category A              | –                                     | Yellow liquid. Toxic if swallowed, by skin contact or by inhalation.  | 3409   |
| –      | T4                                 | TP1           | F-A, S-A               | Category A              | –                                     | Toxic if swallowed, by skin contact or by inhalation.   | 3410   |
| –      | T7                                 | TP2           | F-A, S-A               | Category A              | –                                     | Toxic if swallowed, by skin contact or by inhalation.   | 3411   |
| –      | T7                                 | TP2           | F-A, S-A               | Category A              | –                                     | See entry above.  | 3411   |
| –      | T7                                 | TP2           | F-A, S-B               | Category A<br>SW2       | SGG1<br>SG36<br>SG49                  | Colourless liquid with a pungent odour. Corrosive to most metals. Causes burns to skin, eyes and mucous membranes.  | 3412   |
| –      | T4                                 | TP1           | F-A, S-B               | Category A<br>SW2       | SGG1<br>SG36<br>SG49                  | See entry above.  | 3412   |
| –      | T14                                | TP2<br>TP13   | F-A, S-A               | Category B              | SGG6<br>SG35                          | Reacts with acids or acid fumes, evolving hydrogen cyanide, a highly toxic and flammable gas. Highly toxic if swallowed or by skin contact.   | 3413   |



Part 3 – Dangerous Goods List, special provisions and exceptions

Chapter 3.2 – Dangerous Goods List

| UN No. | Proper shipping name (PSN)                      | Class or division | Subsidiary hazard(s) | Packing group  | Special provisions | Limited and excepted quantity provisions |                     | Packing      |              | IBC           |               |
|--------|---|-------------------|----------------------|----------------|--------------------|--|---------------------|--------------|--------------|---------------|---------------|
|        |   |                   |                      |                |                    | Limited quantities                       | Excepted quantities | Instructions | Provisions   | Instructions  | Provisions    |
| (1)    | (2)<br>3.1.2                                    | (3)<br>2.0        | (4)<br>2.0           | (5)<br>2.0.1.3 | (6)<br>3.3         | (7a)<br>3.4                              | (7b)<br>3.5         | (8)<br>4.1.4 | (9)<br>4.1.4 | (10)<br>4.1.4 | (11)<br>4.1.4 |
| 3413   | POTASSIUM CYANIDE SOLUTION                      | 6.1               | -<br>P               | II             | -                  | 100 mL                                   | E4                  | P001         | PP31         | IBC02         | -             |
| 3413   | POTASSIUM CYANIDE SOLUTION                      | 6.1               | -<br>P               | III            | 223                | 5 L                                      | E1                  | P001<br>LP01 | PP31         | IBC03         | -             |
| 3414   | SODIUM CYANIDE SOLUTION                         | 6.1               | -<br>P               | I              | -                  | 0  | E5                  | P001         | PP31         | -             | -             |
| 3414   | SODIUM CYANIDE SOLUTION                         | 6.1               | -<br>P               | II             | -                  | 100 mL                                   | E4                  | P001         | PP31         | IBC02         | -             |
| 3414   | SODIUM CYANIDE SOLUTION                         | 6.1               | -<br>P               | III            | 223                | 5 L                                      | E1                  | P001<br>LP01 | PP31         | IBC03         | -             |
| 3415   | SODIUM FLUORIDE SOLUTION                        | 6.1               | -                    | III            | 223                | 5 L                                      | E1                  | P001<br>LP01 | -            | IBC03         | -             |
| 3416   | CHLOROACETOPHENONE, LIQUID                      | 6.1               | -                    | II             | -                  | 0  | E0                  | P001         | -            | IBC02         | -             |
| 3417   | XYLYL BROMIDE, SOLID                            | 6.1               | -                    | II             | -                  | 0  | E4                  | P002         | -            | IBC08         | B4<br>B21     |
| 3418   | 2,4-TOLUYLENEDIAMINE SOLUTION                   | 6.1               | -                    | III            | 223                | 5 L                                      | E1                  | P001<br>LP01 | -            | IBC03         | -             |
| 3419   | BORON TRIFLUORIDE ACETIC ACID COMPLEX, SOLID    | 8                 | -                    | II             | -                  | 1 kg                                     | E2                  | P002         | -            | IBC08         | B4<br>B21     |
| 3420   | BORON TRIFLUORIDE PROPIONIC ACID COMPLEX, SOLID | 8                 | -                    | II             | -                  | 1 kg                                     | E2                  | P002         | -            | IBC08         | B4<br>B21     |
| 3421   | POTASSIUM HYDROGEN DIFLUORIDE SOLUTION          | 8                 | 6.1                  | II             | -                  | 1 L                                      | E2                  | P001         | -            | IBC02         | -             |
| 3421   | POTASSIUM HYDROGEN DIFLUORIDE SOLUTION          | 8                 | 6.1                  | III            | 223                | 5 L                                      | E1                  | P001         | -            | IBC03         | -             |
| 3422   | POTASSIUM FLUORIDE SOLUTION                     | 6.1               | -                    | III            | 223                | 5 L                                      | E1                  | P001<br>LP01 | -            | IBC03         | -             |
| △ 3423 | TETRAMETHYLAMMONIUM HYDROXIDE, SOLID            | 6.1               | 8                    | I              | 279<br>409         | 0  | E5                  | P002         | -            | IBC99         | -             |
| 3424   | AMMONIUM DINITRO- <i>o</i> -CRESOLATE SOLUTION  | 6.1               | -<br>P               | II             | -                  | 100 mL                                   | E4                  | P001         | -            | IBC02         | -             |
| 3424   | AMMONIUM DINITRO- <i>o</i> -CRESOLATE SOLUTION  | 6.1               | -<br>P               | III            | 223                | 5 L                                      | E1                  | P001         | -            | IBC02         | -             |

| UN No. | Portable tanks and bulk containers |                     | EmS                    | Stowage and handling           | Segregation                          | Properties and observations   | UN No. |
|--------|------------------------------------|---------------------|------------------------|--------------------------------|--------------------------------------|---|--------|
|        | Tank instructions                  | Provisions          |                        |                                |                                      |   |        |
| (12)   | (13)<br>4.2.5<br>4.3               | (14)<br>4.2.5       | (15)<br>5.4.3.4<br>7.8 | (16a)<br>7.1<br>7.3-7.7        | (16b)<br>7.2-7.7                     | (17)  | (18)   |
| -      | T11                                | TP2<br>TP13<br>TP27 | F-A, <u>S-A</u>        | Category B                     | SGG6<br>SG35                         | Reacts with acids or acid fumes, evolving hydrogen cyanide, a highly toxic and flammable gas. Highly toxic if swallowed or by skin contact.   | 3413   |
| -      | T7                                 | TP2<br>TP13<br>TP28 | F-A, <u>S-A</u>        | Category A                     | SGG6<br>SG35                         | See entry above.  | 3413   |
| -      | T14                                | TP2<br>TP13         | F-A, <u>S-A</u>        | Category B                     | SGG6<br>SG35                         | Reacts with acids or acid fumes, evolving hydrogen cyanide, a highly toxic and flammable gas. Highly toxic if swallowed or by skin contact.   | 3414   |
| -      | T11                                | TP2<br>TP13<br>TP27 | F-A, <u>S-A</u>        | Category B                     | SGG6<br>SG35                         | See entry above.  | 3414   |
| -      | T7                                 | TP2<br>TP13<br>TP28 | F-A, <u>S-A</u>        | Category A                     | SGG6<br>SG35                         | See entry above.  | 3414   |
| -      | T4                                 | TP1                 | F-A, S-A               | Category A                     | SG35                                 | Colourless liquid. Reacts with acids, evolving hydrogen fluoride, a toxic, irritating and corrosive gas, apparent as white fumes. Toxic if swallowed, by skin contact or by inhalation.   | 3415   |
| -      | T7                                 | TP2<br>TP13         | F-A, S-A               | Category D<br>SW1<br>SW2<br>H2 | -                                    | Liquid evolving irritating vapour ("Tear Gas"). Toxic if swallowed, by skin contact or by inhalation.   | 3416   |
| -      | T3                                 | TP33                | F-A, S-G               | Category D<br>SW2              | -                                    | Crystals or powder, evolving irritating vapour ("Tear Gas"). Toxic if swallowed, by skin contact or by inhalation.  | 3417   |
| -      | T4                                 | TP1                 | F-A, S-A               | Category A                     | -                                    | Toxic if swallowed, by skin contact or by inhalation.   | 3418   |
| -      | T3                                 | TP33                | F-A, S-B               | Category A                     | SGG1<br>SG36<br>SG49                 | White crystalline solid. Melting point: 23°C. Highly corrosive to most metals. Causes burns to skin, eyes and mucous membranes.   | 3419   |
| -      | T3                                 | TP33                | F-A, S-B               | Category A                     | SGG1<br>SG36<br>SG49                 | White crystalline solid. Melting point: 28°C. Highly corrosive to most metals. Causes burns to skin, eyes and mucous membranes.   | 3420   |
| -      | T7                                 | TP2                 | F-A, S-B               | Category A<br>SW1<br>SW2       | SGG1<br>SG35<br>SG36<br>SG49         | Decomposed by heat or acids, evolving hydrogen fluoride, a toxic, extremely irritating and corrosive gas apparent as white fumes. In the presence of moisture, highly corrosive to glass, other siliceous materials and most metals. Toxic if swallowed, by skin contact or by inhalation. Causes burns to skin, eyes and mucous membranes. | 3421   |
| -      | T4                                 | TP1                 | F-A, S-B               | Category A<br>SW1<br>SW2       | SGG1<br>SG35<br>SG36<br>SG49         | See entry above.  | 3421   |
| -      | T4                                 | TP1                 | F-A, S-A               | Category A                     | SG35                                 | Decomposed by acids, evolving hydrogen fluoride, an irritating and corrosive gas. Toxic if swallowed, by skin contact or by inhalation.   | 3422   |
| -      | T6                                 | TP33                | F-A, S-B               | Category A                     | SGG2<br>SGG18<br>SG35                | Very soluble in water with a strong ammonia-like odour. Highly toxic if swallowed, by skin contact or by dust inhalation. When heated emits toxic fumes of nitrogen and ammonia. Corrosive to metals and tissue. Causes burns to skin, eyes and mucous membranes. Reacts violently with acids.  | △ 3423 |
| -      | T7                                 | TP2                 | F-A, <u>S-A</u>        | Category B                     | SGG2<br>SG15<br>SG16<br>SG30<br>SG63 | The commercial product is a 50% suspension in water. May support combustion and burn without oxygen. When involved in a fire, evolves toxic fumes. Forms extremely sensitive explosive compounds with lead, silver or other heavy metals and their compounds. Toxic if swallowed, by skin contact or by inhalation.                         | 3424   |
| -      | T7                                 | TP2                 | F-A, <u>S-A</u>        | Category A                     | SGG2<br>SG15<br>SG16<br>SG30<br>SG63 | See entry above.  | 3424   |

Part 3 – Dangerous Goods List, special provisions and exceptions

Chapter 3.2 – Dangerous Goods List

| UN No. | Proper shipping name (PSN)                | Class or division | Subsidiary hazard(s) | Packing group  | Special provisions | Limited and excepted quantity provisions |                     | Packing      |              | IBC           |               |
|--------|---|-------------------|----------------------|----------------|--------------------|--|---------------------|--------------|--------------|---------------|---------------|
|        |   |                   |                      |                |                    | Limited quantities                       | Excepted quantities | Instructions | Provisions   | Instructions  | Provisions    |
| (1)    | (2)<br>3.1.2                              | (3)<br>2.0        | (4)<br>2.0           | (5)<br>2.0.1.3 | (6)<br>3.3         | (7a)<br>3.4                              | (7b)<br>3.5         | (8)<br>4.1.4 | (9)<br>4.1.4 | (10)<br>4.1.4 | (11)<br>4.1.4 |
| 3425   | BROMOACETIC ACID, SOLID                   | 8                 | –                    | II             | –                  | 1 kg                                     | E2                  | P002         | –            | IBC08         | B4<br>B21     |
| 3426   | ACRYLAMIDE SOLUTION                       | 6.1               | –                    | III            | 223                | 5 L                                      | E1                  | P001<br>LP01 | –            | IBC03         | –             |
| 3427   | CHLOROBENZYL CHLORIDES, SOLID             | 6.1               | –<br>P               | III            | –                  | 5 kg                                     | E1                  | P002<br>LP02 | –            | IBC08         | B3            |
| 3428   | 3-CHLORO-4-METHYLPHENYL ISOCYANATE, SOLID | 6.1               | –                    | II             | –                  | 500 g                                    | E4                  | P002         | –            | IBC08         | B4<br>B21     |
| 3429   | CHLOROTOLUIDINES, LIQUID                  | 6.1               | –                    | III            | –                  | 5 L                                      | E1                  | P001<br>LP01 | –            | IBC03         | –             |
| 3430   | XYLENOLS, LIQUID                          | 6.1               | –                    | II             | –                  | 100 mL                                   | E4                  | P001         | –            | IBC02         | –             |
| 3431   | NITROBENZOTRIFLUORIDES, SOLID             | 6.1               | –<br>P               | II             | –                  | 500 g                                    | E4                  | P002         | –            | IBC08         | B4<br>B21     |
| 3432   | POLYCHLORINATED BIPHENYLS, SOLID          | 9                 | –<br>P               | II             | 305<br>958         | 1 kg                                     | E2                  | P906         | –            | IBC08         | B4<br>B21     |
| 3434   | NITROCRESOLS, LIQUID                      | 6.1               | –                    | III            | –                  | 5 L                                      | E1                  | P001<br>LP01 | –            | IBC03         | –             |
| 3436   | HEXAFLUOROACETONE HYDRATE, SOLID          | 6.1               | –                    | II             | –                  | 500 g                                    | E4                  | P002         | –            | IBC08         | B4<br>B21     |
| 3437   | CHLOROCRESOLS, SOLID                      | 6.1               | –                    | II             | –                  | 500 g                                    | E4                  | P002         | –            | IBC08         | B4<br>B21     |
| 3438   | alpha-METHYLBENZYL ALCOHOL, SOLID         | 6.1               | –                    | III            | –                  | 5 kg                                     | E1                  | P002<br>LP02 | –            | IBC08         | B3            |
| 3439   | NITRILES, SOLID, TOXIC, N.O.S.            | 6.1               | –                    | I              | 274                | 0  | E5                  | P002         | –            | IBC07         | B1            |
| 3439   | NITRILES, SOLID, TOXIC, N.O.S.            | 6.1               | –                    | II             | 274                | 500 g                                    | E4                  | P002         | –            | IBC08         | B4<br>B21     |
| 3439   | NITRILES, SOLID, TOXIC, N.O.S.            | 6.1               | –                    | III            | 223<br>274         | 5 kg                                     | E1                  | P002<br>LP02 | –            | IBC08         | B3            |
| 3440   | SELENIUM COMPOUND, LIQUID, N.O.S.         | 6.1               | –                    | I              | 274                | 0  | E5                  | P001         | –            | –             | –             |
| 3440   | SELENIUM COMPOUND, LIQUID, N.O.S.         | 6.1               | –                    | II             | 274                | 100 mL                                   | E4                  | P001         | –            | IBC02         | –             |
| 3440   | SELENIUM COMPOUND, LIQUID, N.O.S.         | 6.1               | –                    | III            | 223<br>274         | 5 L                                      | E1                  | P001         | –            | IBC03         | –             |
| 3441   | CHLORODINITROBENZENES, SOLID              | 6.1               | –<br>P               | II             | 279                | 500 g                                    | E4                  | P002         | –            | IBC08         | B4<br>B21     |
| 3442   | DICHLOROANILINES, SOLID                   | 6.1               | –<br>P               | II             | 279                | 500 g                                    | E4                  | P002         | –            | IBC08         | B4<br>B21     |

| UN No. | Portable tanks and bulk containers |               | EmS                    | Stowage and handling    | Segregation          | Properties and observations  | UN No. |
|--------|------------------------------------|---------------|------------------------|-------------------------|----------------------|--|--------|
|        | Tank instructions                  | Provisions    |                        |                         |                      |  |        |
| (12)   | (13)<br>4.2.5<br>4.3               | (14)<br>4.2.5 | (15)<br>5.4.3.4<br>7.8 | (16a)<br>7.1<br>7.3–7.7 | (16b)<br>7.2–7.7     | (17)   | (18)   |
| –      | T3                                 | TP33          | F-A, S-B               | Category A              | SGG1<br>SG36<br>SG49 | Colourless, deliquescent crystals. Melting point: 51°C. Corrosive to most metals. Harmful if swallowed. Causes burns to eyes and skin.   | 3425   |
| –      | T4                                 | TP1           | F-A, S-A               | Category A<br>SW1<br>H2 | –                    | Toxic if swallowed, by skin contact or by inhalation.  | 3426   |
| –      | T1                                 | TP33          | F-A, S-A               | Category A              | –                    | Colourless crystalline solid. Melting point: 29°C. Immiscible with or insoluble in water. Toxic if swallowed, by skin contact or by inhalation.  | 3427   |
| –      | T3                                 | TP33          | F-A, S-A               | Category B<br>SW2       | –                    | Colourless solid with a pungent odour. Melting point: 23°C. Insoluble in water. Reacts with water, evolving carbon dioxide. Toxic if swallowed, by skin contact or by inhalation. Irritating to skin, eyes and mucous membranes.   | 3428   |
| –      | T4                                 | TP1           | F-A, S-A               | Category A              | –                    | Brown liquid. Toxic if swallowed, by skin contact or by inhalation.  | 3429   |
| –      | T7                                 | TP2           | F-A, S-A               | Category A              | –                    | The commercial products are liquids with a pungent tar odour. Toxic if swallowed, by skin contact or by inhalation.  | 3430   |
| –      | T3                                 | TP33          | F-A, S-A               | Category A<br>SW2       | –                    | Low melting point (31°C to 32°C) solids with an aromatic odour. Insoluble in water. Toxic if swallowed, by skin contact or by inhalation.  | 3431   |
| –      | T3                                 | TP33          | F-A, S-A               | Category A              | SG50                 | Solids with perceptible odour. Insoluble in water. Harmful by ingestion or by skin contact. If spilled, can be a persistent hazard to the environment. This entry also covers articles, such as rags, cotton waste, clothing or sawdust, containing polychlorinated biphenyls where no free visible liquid is present. | 3432   |
| –      | T4                                 | TP1           | F-A, S-A               | Category A              | –                    | Slightly miscible in water. Toxic if swallowed, by skin contact or by inhalation.  | 3434   |
| –      | T3                                 | TP33          | F-A, S-A               | Category B<br>SW2       | –                    | This entry covers solid hydrate and hexafluoroacetone. Melting point of the pure substance: 23°C. Toxic if swallowed, by skin contact or by inhalation.  | 3436   |
| –      | T3                                 | TP33          | F-A, S-A               | Category A<br>SW1<br>H2 | –                    | White or pink crystals with a phenol-like odour. Melting point: 45°C to 68°C. Slightly soluble in water. Decomposes when heated, evolving extremely toxic fumes (phosgene). Toxic if swallowed, by skin contact or by inhalation.  | 3437   |
| –      | T1                                 | TP33          | F-A, S-A               | Category A              | –                    | Slightly soluble in water. Melting point: 21°C (pure substance). Toxic if swallowed, by skin contact or by inhalation.   | 3438   |
| –      | T6                                 | TP33          | F-A, S-A               | Category B              | SG35                 | Solid, evolving toxic vapours. Reacts with acids or acid fumes, evolving hydrogen cyanide, a highly toxic and flammable gas. Soluble in water. Toxic if swallowed, by skin contact or by inhalation.   | 3439   |
| –      | T3                                 | TP33          | F-A, S-A               | Category B              | SG35                 | See entry above.   | 3439   |
| –      | T1                                 | TP33          | F-A, S-A               | Category A              | SG35                 | See entry above.   | 3439   |
| –      | T14                                | TP2<br>TP27   | F-A, S-A               | Category B              | –                    | Toxic if swallowed, by skin contact or by inhalation.  | 3440   |
| –      | T11                                | TP2<br>TP27   | F-A, S-A               | Category B              | –                    | See entry above.   | 3440   |
| –      | T7                                 | TP1<br>TP28   | F-A, S-A               | Category A              | –                    | See entry above.   | 3440   |
| –      | T3                                 | TP33          | F-A, S-A               | Category A              | SG15                 | Crystals. Melting point: 27°C to 53°C. May explode if involved in a fire. Toxic if swallowed, by skin contact or by inhalation.  | 3441   |
| –      | T3                                 | TP33          | F-A, S-A               | Category A<br>SW2       | –                    | Solid with a penetrating odour. Liquid mixtures of various isomers of dichloroanilines, some of which in the pure state may be solid, with a melting point varying from 24°C to 72°C. Toxic if swallowed, by skin contact or by inhalation.  | 3442   |



Part 3 – Dangerous Goods List, special provisions and exceptions

Chapter 3.2 – Dangerous Goods List

| UN No. | Proper shipping name (PSN)        | Class or division | Subsidiary hazard(s) | Packing group  | Special provisions | Limited and excepted quantity provisions |                     | Packing      |              | IBC           |               |
|--------|-----------------------------------|-------------------|----------------------|----------------|--------------------|--|---------------------|--------------|--------------|---------------|---------------|
|        |                                   |                   |                      |                |                    | Limited quantities                       | Excepted quantities | Instructions | Provisions   | Instructions  | Provisions    |
| (1)    | (2)<br>3.1.2                      | (3)<br>2.0        | (4)<br>2.0           | (5)<br>2.0.1.3 | (6)<br>3.3         | (7a)<br>3.4                              | (7b)<br>3.5         | (8)<br>4.1.4 | (9)<br>4.1.4 | (10)<br>4.1.4 | (11)<br>4.1.4 |
| 3443   | DINITROBENZENES, SOLID            | 6.1               | –                    | II             | –                  | 500 g                                    | E4                  | P002         | –            | IBC08         | B4<br>B21     |
| 3444   | NICOTINE HYDROCHLORIDE, SOLID     | 6.1               | –                    | II             | 43                 | 500 g                                    | E4                  | P002         | –            | IBC08         | B4<br>B21     |
| 3445   | NICOTINE SULPHATE, SOLID          | 6.1               | –                    | II             | –                  | 500 g                                    | E4                  | P002         | –            | IBC08         | B4<br>B21     |
| 3446   | NITROTOLUENES, SOLID              | 6.1               | –                    | II             | –                  | 500 g                                    | E4                  | P002         | –            | IBC08         | B4<br>B21     |
| 3447   | NITROXYLENES, SOLID               | 6.1               | –                    | II             | –                  | 500 g                                    | E4                  | P002         | –            | IBC08         | B4<br>B21     |
| 3448   | TEAR GAS SUBSTANCE, SOLID, N.O.S. | 6.1               | –                    | I              | 274                | 0  | E0                  | P002         | PP31         | –             | –             |
| 3448   | TEAR GAS SUBSTANCE, SOLID, N.O.S. | 6.1               | –                    | II             | 274                | 0  | E0                  | P002         | PP31         | IBC08         | B4<br>B21     |
| 3449   | BROMOBENZYL CYANIDES, SOLID       | 6.1               | –                    | I              | 138                | 0  | E5                  | P002         | PP31         | –             | –             |
| 3450   | DIPHENYLCHLOROARSINE, SOLID       | 6.1               | –<br>P               | I              | –                  | 0  | E0                  | P002         | PP31         | IBC07         | B1            |
| 3451   | TOLUIDINES, SOLID                 | 6.1               | –<br>P               | II             | 279                | 500 g                                    | E4                  | P002         | –            | IBC08         | B4<br>B21     |
| 3452   | XYLIDINES, SOLID                  | 6.1               | –                    | II             | –                  | 500 g                                    | E4                  | P002         | –            | IBC08         | B4<br>B21     |
| 3453   | PHOSPHORIC ACID, SOLID            | 8                 | –                    | III            | –                  | 5 kg                                     | E1                  | P002<br>LP02 | –            | IBC08         | B3            |
| 3454   | DINITROTOLUENES, SOLID            | 6.1               | –<br>P               | II             | –                  | 500 g                                    | E4                  | P002         | –            | IBC08         | B4<br>B21     |
| 3455   | CRESOLS, SOLID                    | 6.1               | 8                    | II             | –                  | 500 g                                    | E4                  | P002         | –            | IBC08         | B4<br>B21     |
| 3456   | NITROSYLSULPHURIC ACID, SOLID     | 8                 | –                    | II             | –                  | 1 kg                                     | E2                  | P002         | –            | IBC08         | B4<br>B21     |
| 3457   | CHLORONITROTOLUENES, SOLID        | 6.1               | –<br>P               | III            | –                  | 5 kg                                     | E1                  | P002<br>LP02 | –            | IBC08         | B3            |
| 3458   | NITROANISOLES, SOLID              | 6.1               | –                    | III            | 279                | 5 kg                                     | E1                  | P002<br>LP02 | –            | IBC08         | B3            |
| 3459   | NITROBROMOBENZENES, SOLID         | 6.1               | –                    | III            | –                  | 5 kg                                     | E1                  | P002<br>LP02 | –            | IBC08         | B3            |

| UN No. | Portable tanks and bulk containers |               | EmS                    | Stowage and handling           | Segregation   | Properties and observations  | UN No. |
|--------|------------------------------------|---------------|------------------------|--------------------------------|---|--|--------|
|        | Tank instructions                  | Provisions    |                        |                                |   |  |        |
| (12)   | (13)<br>4.2.5<br>4.3               | (14)<br>4.2.5 | (15)<br>5.4.3.4<br>7.8 | (16a)<br>7.1<br>7.3–7.7        | (16b)<br>7.2–7.7                                    | (17)   | (18)   |
| –      | T3                                 | TP33          | F-A, S-A               | Category A                     | SG15  | May explode if involved in a fire. Toxic if swallowed, by skin contact or by inhalation.   | 3443   |
| –      | T3                                 | TP33          | F-A, S-A               | Category A                     | –   | Deliquescent crystals or solids or pastes. Soluble in water. Toxic if swallowed, by skin contact or by inhalation.   | 3444   |
| –      | T3                                 | TP33          | F-A, S-A               | Category A                     | –   | Solid or paste. Soluble in water. Toxic if swallowed, by skin contact or by inhalation.  | 3445   |
| –      | T3                                 | TP33          | F-A, S-A               | Category A                     | –   | Yellow solid. Melting point: <i>para</i> -NITROTOLUENE: 52°C to 54°C. Toxic if swallowed, by skin contact or by inhalation.  | 3446   |
| –      | T3                                 | TP33          | F-A, S-A               | Category A                     | –   | Yellow solid. Melting points: 4-NITRO-2-XYLENE: 29°C to 31°C, 5-NITRO-3-XYLENE: 72°C to 74°C. Insoluble in water. Toxic if swallowed, by skin contact or by inhalation.  | 3447   |
| –      | T6                                 | TP33          | F-A, S-A               | Category D<br>SW2              | –   | “Tear gas substance” is a generic term for substances which, in minute quantities dispersed in air, cause extreme eye irritation and profuse tears. Toxic if swallowed, by skin contact or by inhalation.  | 3448   |
| –      | T3                                 | TP33          | F-A, S-A               | Category D<br>SW2              | –   | See entry above.   | 3448   |
| –      | T6                                 | TP33          | F-A, S-A               | Category D<br>SW1<br>SW2<br>H2 | SGG6<br>SG35  | Volatile, yellow crystals evolving irritating vapours (“Tear Gas”). Melting point: <i>meta</i> -BROMOBENZYL CYANIDE 25°C. Highly toxic if swallowed, by skin contact or by inhalation.   | 3449   |
| –      | T6                                 | TP33          | F-A, S-A               | Category D<br>SW2              | –   | When pure, volatile, colourless crystals evolving an irritating vapour (“Tear Gas”). Melting point: 41°C. Highly toxic if swallowed, by skin contact or by inhalation.   | 3450   |
| –      | T3                                 | TP33          | F-A, S-A               | Category A                     | –   | <i>para</i> -TOLUIDINE is solid in pure form, with a melting point of approximately 45°C. Toxic if swallowed, by skin contact or by inhalation.  | 3451   |
| –      | T3                                 | TP33          | F-A, S-A               | Category A                     | –   | 3,4-Dimethylaniline is a solid, which has a melting point of 47°C. Toxic if swallowed, by skin contact or by dust inhalation.  | 3452   |
| –      | T1                                 | TP33          | F-A, S-B               | Category A                     | SGG1<br>SG36<br>SG49                                | Very deliquescent, crystalline solid. Melting point: 42°C. Soluble in water. Mildly corrosive to most metals.  | 3453   |
| –      | T3                                 | TP33          | F-A, S-A               | Category A                     | –   | Yellow crystals or flakes, insoluble in water. Toxic if swallowed, by skin contact or by inhalation.   | 3454   |
| –      | T3                                 | TP33          | F-A, S-B               | Category B                     | –   | Light yellow solid. Soluble in water. Melting points of CRESOLS: <i>ortho</i> -CRESOL: 30°C, <i>para</i> -CRESOL: 35°C. Toxic if swallowed, by skin contact or by inhalation. Cause burns to skin, eyes and mucous membranes.                                    | 3455   |
| –      | T3                                 | TP33          | F-A, S-B               | Category D<br>SW2              | SGG1<br>SG6<br>SG16<br>SG17<br>SG19<br>SG36<br>SG49 | Crystalline solid. Oxidant which may cause fire with organic materials (such as wood, straw, etc.). When involved in a fire, evolves toxic gases. In the presence of moisture, highly corrosive to most metals. Causes burns to skin, eyes and mucous membranes. | 3456   |
| –      | T1                                 | TP33          | F-A, S-A               | Category A                     | SG6<br>SG8<br>SG10<br>SG12                          | Melting range 20°C to 40°C. Insoluble in water. Oxidizing substance which may explode or burn fiercely when in contact with organic materials. Toxic if swallowed, by skin contact or by inhalation.   | 3457   |
| –      | T1                                 | TP33          | F-A, S-A               | Category A                     | –   | Light reddish or amber crystals. Melting points: 38°C to 54°C. Insoluble in water. Toxic if swallowed, by skin contact or by inhalation.   | 3458   |
| –      | T1                                 | TP33          | F-A, S-A               | Category A                     | –   | Colourless to pale yellow crystals which may liquefy under transport conditions. Melting points: 1-BROMO-2-NITROBENZENE: 43°C. 1-BROMO-4-NITROBENZENE: 127°C. Insoluble in water. Toxic if swallowed, by skin contact or by inhalation.                          | 3459   |

Part 3 – Dangerous Goods List, special provisions and exceptions

Chapter 3.2 – Dangerous Goods List

| UN No. | Proper shipping name (PSN)  | Class or division | Subsidiary hazard(s) | Packing group  | Special provisions | Limited and excepted quantity provisions |                     | Packing      |              | IBC           |               |
|--------|---|-------------------|----------------------|----------------|--------------------|--|---------------------|--------------|--------------|---------------|---------------|
|        |   |                   |                      |                |                    | Limited quantities                       | Excepted quantities | Instructions | Provisions   | Instructions  | Provisions    |
| (1)    | (2)<br>3.1.2  | (3)<br>2.0        | (4)<br>2.0           | (5)<br>2.0.1.3 | (6)<br>3.3         | (7a)<br>3.4                              | (7b)<br>3.5         | (8)<br>4.1.4 | (9)<br>4.1.4 | (10)<br>4.1.4 | (11)<br>4.1.4 |
| 3460   | N-ETHYLBENZYL TOLUIDINES, SOLID   | 6.1               | -                    | III            | -                  | 5 kg                                     | E1                  | P002<br>LP02 | -            | IBC08         | B3            |
| 3462   | TOXINS, EXTRACTED FROM LIVING SOURCES, SOLID, N.O.S.  | 6.1               | -                    | I              | 210<br>274         | 0  | E5                  | P002         | -            | IBC07         | B1            |
| 3462   | TOXINS, EXTRACTED FROM LIVING SOURCES, SOLID, N.O.S.  | 6.1               | -                    | II             | 210<br>274         | 500 g                                    | E4                  | P002         | -            | IBC08         | B4<br>B21     |
| 3462   | TOXINS, EXTRACTED FROM LIVING SOURCES, SOLID, N.O.S.  | 6.1               | -                    | III            | 210<br>223<br>274  | 5 kg                                     | E1                  | P002         | -            | IBC08         | B3            |
| 3463   | PROPIONIC ACID, with not less than 90% acid by mass   | 8                 | 3                    | II             | -                  | 1 L                                      | E2                  | P001         | -            | IBC02         | -             |
| 3464   | ORGANOPHOSPHORUS COMPOUND, SOLID, TOXIC, N.O.S.   | 6.1               | -                    | I              | 43<br>274          | 0  | E5                  | P002         | -            | IBC07         | B1            |
| 3464   | ORGANOPHOSPHORUS COMPOUND, SOLID, TOXIC, N.O.S.   | 6.1               | -                    | II             | 43<br>274          | 500 g                                    | E4                  | P002         | -            | IBC08         | B4<br>B21     |
| 3464   | ORGANOPHOSPHORUS COMPOUND, SOLID, TOXIC, N.O.S.   | 6.1               | -                    | III            | 43<br>223<br>274   | 5 kg                                     | E1                  | P002<br>LP02 | -            | IBC08         | B3            |
| 3465   | ORGANOARSENIC COMPOUND, SOLID, N.O.S.   | 6.1               | -                    | I              | 274                | 0  | E5                  | P002         | -            | IBC07         | B1            |
| 3465   | ORGANOARSENIC COMPOUND, SOLID, N.O.S.   | 6.1               | -                    | II             | 274                | 500 g                                    | E4                  | P002         | -            | IBC08         | B4<br>B21     |
| 3465   | ORGANOARSENIC COMPOUND, SOLID, N.O.S.   | 6.1               | -                    | III            | 223<br>274         | 5 kg                                     | E1                  | P002<br>LP02 | -            | IBC08         | B3            |
| 3466   | METAL CARBONYLS, SOLID, N.O.S.  | 6.1               | -                    | I              | 274                | 0  | E5                  | P002         | -            | IBC07         | B1            |
| 3466   | METAL CARBONYLS, SOLID, N.O.S.  | 6.1               | -                    | II             | 274                | 500 g                                    | E4                  | P002         | -            | IBC08         | B4<br>B21     |
| 3466   | METAL CARBONYLS, SOLID, N.O.S.  | 6.1               | -                    | III            | 223<br>274         | 5 kg                                     | E1                  | P002<br>LP02 | -            | IBC08         | B3            |
| 3467   | ORGANOMETALLIC COMPOUND, SOLID, TOXIC, N.O.S.   | 6.1               | -                    | I              | 274                | 0  | E5                  | P002         | -            | IBC07         | B1            |
| 3467   | ORGANOMETALLIC COMPOUND, SOLID, TOXIC, N.O.S.   | 6.1               | -                    | II             | 274                | 500 g                                    | E4                  | P002         | -            | IBC08         | B4<br>B21     |
| 3467   | ORGANOMETALLIC COMPOUND, SOLID, TOXIC, N.O.S.   | 6.1               | -                    | III            | 223<br>274         | 5 kg                                     | E1                  | P002<br>LP02 | -            | IBC08         | B3            |
| 3468   | HYDROGEN IN A METAL HYDRIDE STORAGE SYSTEM or HYDROGEN IN A METAL HYDRIDE STORAGE SYSTEM CONTAINED IN EQUIPMENT or HYDROGEN IN A METAL HYDRIDE STORAGE SYSTEM PACKED WITH EQUIPMENT | 2.1               | -                    | -              | 321<br>356         | 0  | E0                  | P205         | -            | -             | -             |

| UN No. | Portable tanks and bulk containers |               | EmS                    | Stowage and handling    | Segregation          | Properties and observations   | UN No. |
|--------|------------------------------------|---------------|------------------------|-------------------------|----------------------|---|--------|
|        | Tank instructions                  | Provisions    |                        |                         |                      |   |        |
| (12)   | (13)<br>4.2.5<br>4.3               | (14)<br>4.2.5 | (15)<br>5.4.3.4<br>7.8 | (16a)<br>7.1<br>7.3-7.7 | (16b)<br>7.2-7.7     | (17)  | (18)   |
| -      | T1                                 | TP33          | F-A, S-A               | Category A              | -                    | Solid which may liquefy under transport conditions. Strong odour. Insoluble in water. Toxic if swallowed, by skin contact or by inhalation.   | 3460   |
| -      | T6                                 | TP33          | F-A, S-A               | Category B              | -                    | Toxins from plant, animal or bacterial sources which contain infectious substances or toxins that are contained in infectious substances should be classified in class 6.2. Toxic if swallowed, by skin contact or by inhalation. | 3462   |
| -      | T3                                 | TP33          | F-A, S-A               | Category B              | -                    | See entry above.  | 3462   |
| -      | T1                                 | TP33          | F-A, S-A               | Category A              | -                    | See entry above.  | 3462   |
| -      | T7                                 | TP2           | F-E, S-C               | Category A              | SGG1<br>SG36<br>SG49 | Colourless flammable liquid with a pungent odour. Miscible with water. Corrosive to lead and most other metals. Burns skin. Vapours irritate mucous membranes. Pure PROPIONIC ACID: flashpoint 50°C c.c.                          | 3463   |
| -      | T6                                 | TP33          | F-A, S-A               | Category B              | -                    | Toxic if swallowed, by skin contact or by inhalation.   | 3464   |
| -      | T3                                 | TP33          | F-A, S-A               | Category B              | -                    | See entry above.  | 3464   |
| -      | T1                                 | TP33          | F-A, S-A               | Category A              | -                    | See entry above.  | 3464   |
| -      | T6                                 | TP33          | F-A, S-A               | Category B              | -                    | Toxic if swallowed, by skin contact or by inhalation.   | 3465   |
| -      | T3                                 | TP33          | F-A, S-A               | Category B              | -                    | See entry above.  | 3465   |
| -      | T1                                 | TP33          | F-A, S-A               | Category A              | -                    | See entry above.  | 3465   |
| -      | T6                                 | TP33          | F-A, S-A               | Category D<br>SW2       | -                    | Insoluble in water. Toxic if swallowed, by skin contact or by dust inhalation.  | 3466   |
| -      | T3                                 | TP33          | F-A, S-A               | Category D<br>SW2       | -                    | See entry above.  | 3466   |
| -      | T1                                 | TP33          | F-A, S-A               | Category D<br>SW2       | -                    | See entry above.  | 3466   |
| -      | T6                                 | TP33          | F-A, S-A               | Category B              | -                    | Toxic if swallowed, by skin contact or by inhalation.   | 3467   |
| -      | T3                                 | TP33          | F-A, S-A               | Category B              | -                    | See entry above.  | 3467   |
| -      | T1                                 | TP33          | F-A, S-A               | Category A              | -                    | See entry above.  | 3467   |
| -      | -                                  | -             | F-D, S-U               | Category D              | -                    | Article containing flammable odourless gas, which is much lighter than air.   | 3468   |

Part 3 – Dangerous Goods List, special provisions and exceptions

Chapter 3.2 – Dangerous Goods List

| UN No. | Proper shipping name (PSN)   | Class or division | Subsidiary hazard(s) | Packing group  | Special provisions | Limited and excepted quantity provisions |                     | Packing      |              | IBC           |               |
|--------|--|-------------------|----------------------|----------------|--------------------|--|---------------------|--------------|--------------|---------------|---------------|
|        |  |                   |                      |                |                    | Limited quantities                       | Excepted quantities | Instructions | Provisions   | Instructions  | Provisions    |
| (1)    | (2)<br>3.1.2   | (3)<br>2.0        | (4)<br>2.0           | (5)<br>2.0.1.3 | (6)<br>3.3         | (7a)<br>3.4                              | (7b)<br>3.5         | (8)<br>4.1.4 | (9)<br>4.1.4 | (10)<br>4.1.4 | (11)<br>4.1.4 |
| 3469   | PAINT, FLAMMABLE, CORROSIVE (including paint, lacquer, enamel, stain, shellac, varnish, polish, liquid filler and liquid lacquer base) or PAINT RELATED MATERIAL, FLAMMABLE, CORROSIVE (including paint thinning or reducing compound) | 3                 | 8                    | I              | 163<br>367         | 0  | E0                  | P001         | -            | -             | -             |
| 3469   | PAINT, FLAMMABLE, CORROSIVE (including paint, lacquer, enamel, stain, shellac, varnish, polish, liquid filler and liquid lacquer base) or PAINT RELATED MATERIAL, FLAMMABLE, CORROSIVE (including paint thinning or reducing compound) | 3                 | 8                    | II             | 163<br>367         | 1 L                                      | E2                  | P001         | -            | IBC02         | -             |
| 3469   | PAINT, FLAMMABLE, CORROSIVE (including paint, lacquer, enamel, stain, shellac, varnish, polish, liquid filler and liquid lacquer base) or PAINT RELATED MATERIAL, FLAMMABLE, CORROSIVE (including paint thinning or reducing compound) | 3                 | 8                    | III            | 163<br>223<br>367  | 5 L                                      | E1                  | P001         | -            | IBC03         | -             |
| 3470   | PAINT, CORROSIVE, FLAMMABLE (including paint, lacquer, enamel, stain, shellac, varnish, polish, liquid filler and liquid lacquer base) or PAINT RELATED MATERIAL, CORROSIVE, FLAMMABLE (including paint thinning or reducing compound) | 8                 | 3                    | II             | 163<br>367         | 1 L                                      | E2                  | P001         | -            | IBC02         | -             |
| 3471   | HYDROGENDIFLUORIDES SOLUTION, N.O.S.   | 8                 | 6.1                  | II             | -                  | 1 L                                      | E2                  | P001         | -            | IBC02         | -             |
| 3471   | HYDROGENDIFLUORIDES SOLUTION, N.O.S.   | 8                 | 6.1                  | III            | 223                | 5 L                                      | E1                  | P001         | -            | IBC03         | -             |
| 3472   | CROTONIC ACID, LIQUID  | 8                 | -                    | III            | -                  | 5 L                                      | E1                  | P001<br>LP01 | -            | IBC03         | -             |
| 3473   | FUEL CELL CARTRIDGES or FUEL CELL CARTRIDGES CONTAINED IN EQUIPMENT or FUEL CELL CARTRIDGES PACKED WITH EQUIPMENT containing flammable liquids   | 3                 | -                    | -              | 328                | 1 L                                      | E0                  | P004         | -            | -             | -             |
| 3474   | 1-HYDROXYBENZOTRIAZOLE MONOHYDRATE   | 4.1               | -                    | I              | -                  | 0  | E0                  | P406         | PP48         | -             | -             |

| UN No. | Portable tanks and bulk containers |                    | EmS                    | Stowage and handling     | Segregation          | Properties and observations  | UN No. |
|--------|------------------------------------|--------------------|------------------------|--------------------------|----------------------|--|--------|
|        | Tank instructions                  | Provisions         |                        |                          |                      |  |        |
| (12)   | (13)<br>4.2.5<br>4.3               | (14)<br>4.2.5      | (15)<br>5.4.3.4<br>7.8 | (16a)<br>7.1<br>7.3-7.7  | (16b)<br>7.2-7.7     | (17)   | (18)   |
| -      | T11                                | TP2<br>TP27        | F-E, S-C               | Category E<br>SW2        | -                    | Miscibility with water depends upon the composition. Corrosive contents cause burns to skin, eyes and mucous membranes.  | 3469   |
| -      | T7                                 | TP2<br>TP8<br>TP28 | F-E, S-C               | Category B<br>SW2        | -                    | See entry above.   | 3469   |
| -      | T4                                 | TP1<br>TP29        | F-E, S-C               | Category A<br>SW2        | -                    | See entry above.   | 3469   |
| -      | T7                                 | TP2<br>TP8<br>TP28 | F-E, S-C               | Category B<br>SW2        | -                    | Miscibility with water depends upon the composition. Corrosive contents cause burns to skin, eyes and mucous membranes.  | 3470   |
| -      | T7                                 | TP2                | F-A, S-B               | Category A<br>SW1<br>SW2 | SG35                 | When involved in a fire or in contact with acids, evolves hydrogen fluoride, an extremely irritating and corrosive gas. Corrosive to glass, other siliceous materials and most metals. Toxic if swallowed, by skin contact or by inhalation. Causes burns to skin, eyes and mucous membranes.                | 3471   |
| -      | T4                                 | TP1                | F-A, S-B               | Category A<br>SW1<br>SW2 | SG35                 | See entry above.   | 3471   |
| -      | T4                                 | TP1                | F-A, S-B               | Category A<br>SW1<br>H2  | SGG1<br>SG36<br>SG49 | Causes burns to skin, eyes and mucous membranes.   | 3472   |
| -      | -                                  | -                  | F-E, S-D               | Category A               | -                    | Fuel cell cartridges containing flammable liquids including methanol or methanol/water solutions. Fuel cell cartridges may also be shipped in, or packed with, equipment.  | 3473   |
| -      | -                                  | -                  | F-B, S-J               | Category D               | SG7<br>SG30          | Desensitized explosive. White to light beige powder. Explosive and sensitive to friction in the dry state. When involved in a fire, evolves toxic fumes; in closed compartments these fumes may form an explosive mixture with air. May form extremely sensitive compounds with heavy metals or their salts. | 3474   |

| UN No. | Proper shipping name (PSN)  | Class or division | Subsidiary hazard(s) | Packing group  | Special provisions   | Limited and excepted quantity provisions |                     | Packing  |              | IBC           |               |
|--------|---|-------------------|----------------------|----------------|--|--|---------------------|--|--------------|---------------|---------------|
|        |   |                   |                      |                |  | Limited quantities                       | Excepted quantities | Instructions   | Provisions   | Instructions  | Provisions    |
| (1)    | (2)<br>3.1.2  | (3)<br>2.0        | (4)<br>2.0           | (5)<br>2.0.1.3 | (6)<br>3.3   | (7a)<br>3.4                              | (7b)<br>3.5         | (8)<br>4.1.4   | (9)<br>4.1.4 | (10)<br>4.1.4 | (11)<br>4.1.4 |
| 3475   | ETHANOL AND GASOLINE MIXTURE or ETHANOL AND MOTOR SPIRIT MIXTURE or ETHANOL AND PETROL MIXTURE, with more than 10% ethanol                              | 3                 | –                    | II             | 333  | 1 L                                      | E2                  | P001   | –            | IBC02         | –             |
| 3476   | FUEL CELL CARTRIDGES or FUEL CELL CARTRIDGES CONTAINED IN EQUIPMENT or FUEL CELL CARTRIDGES PACKED WITH EQUIPMENT, containing water-reactive substances | 4.3               | –                    | –              | 328<br>334   | 500 mL<br>or 500 g                       | E0                  | P004   | –            | –             | –             |
| 3477   | FUEL CELL CARTRIDGES or FUEL CELL CARTRIDGES CONTAINED IN EQUIPMENT or FUEL CELL CARTRIDGES PACKED WITH EQUIPMENT, containing corrosive substances      | 8                 | –                    | –              | 328<br>334   | 1 L<br>or 1 kg                           | E0                  | P004   | –            | –             | –             |
| 3478   | FUEL CELL CARTRIDGES or FUEL CELL CARTRIDGES CONTAINED IN EQUIPMENT or FUEL CELL CARTRIDGES PACKED WITH EQUIPMENT, containing liquefied flammable gas   | 2.1               | –                    | –              | 328<br>338   | 120 mL                                   | E0                  | P004   | –            | –             | –             |
| 3479   | FUEL CELL CARTRIDGES or FUEL CELL CARTRIDGES CONTAINED IN EQUIPMENT or FUEL CELL CARTRIDGES PACKED WITH EQUIPMENT, containing hydrogen in metal hydride | 2.1               | –                    | –              | 328<br>339   | 120 mL                                   | E0                  | P004   | –            | –             | –             |
| △ 3480 | LITHIUM ION BATTERIES (including lithium ion polymer batteries)   | 9                 | –                    | –              | 188<br>230<br>310<br>348<br>376<br>377<br>384<br>387               | 0  | E0                  | P903<br>P908<br>P909<br>P910<br>P911<br>LP903<br>LP904<br>LP905<br>LP906 | –            | –             | –             |
| △ 3481 | LITHIUM ION BATTERIES CONTAINED IN EQUIPMENT or LITHIUM ION BATTERIES PACKED WITH EQUIPMENT (including lithium ion polymer batteries)                   | 9                 | –                    | –              | 188<br>230<br>310<br>348<br>360<br>376<br>377<br>384<br>387<br>390 | 0  | E0                  | P903<br>P908<br>P909<br>P910<br>P911<br>LP903<br>LP904<br>LP905<br>LP906 | –            | –             | –             |
| △ 3482 | ALKALI METAL DISPERSION, FLAMMABLE or ALKALINE EARTH METAL DISPERSION, FLAMMABLE  | 4.3               | 3                    | I              | 182<br>183   | 0  | E0                  | P402   | PP31         | –             | –             |
| 3483   | MOTOR FUEL ANTI-KNOCK MIXTURE, FLAMMABLE  | 6.1               | 3<br>P               | I              | –  | 0  | E0                  | P602   | –            | –             | –             |

| UN No. | Portable tanks and bulk containers |                    | EmS                    | Stowage and handling     | Segregation      | Properties and observations  | UN No. |
|--------|------------------------------------|--------------------|------------------------|--------------------------|------------------|--|--------|
|        | Tank instructions                  | Provisions         |                        |                          |                  |  |        |
| (12)   | (13)<br>4.2.5<br>4.3               | (14)<br>4.2.5      | (15)<br>5.4.3.4<br>7.8 | (16a)<br>7.1<br>7.3–7.7  | (16b)<br>7.2–7.7 | (17)   | (18)   |
| –      | T4                                 | TP1                | F-E, S-E               | Category E               | –                | Colourless, volatile liquids. Miscibility with water depends on the composition.   | 3475   |
| –      | –                                  | –                  | F-G, S-P               | Category A<br>H1         | SG26             | Fuel cell cartridges containing water-reactive substances may also be shipped in, or packed with, equipment.   | 3476   |
| –      | –                                  | –                  | F-A, S-B               | Category A               | –                | Fuel cell cartridges containing corrosive substances may also be shipped in, or packed with, equipment.  | 3477   |
| –      | –                                  | –                  | F-D, S-U               | Category B               | –                | Fuel cell cartridges containing butane or other flammable liquefied gas may also be shipped in, or packed with, equipment.   | 3478   |
| –      | –                                  | –                  | F-D, S-U               | Category B               | –                | Fuel cell cartridges containing hydrogen, butane or other flammable odourless gas, which is much lighter than air, may also be shipped in or packed with equipment.  | 3479   |
| –      | –                                  | –                  | F-A, S-I               | Category A<br>SW19       | –                | Electrical batteries containing lithium ion may react (e.g. flame, heat, emission of toxic, corrosive or flammable gases or vapours) or disassemble due to damage, defects or short circuit.                                     | 3480 △ |
| –      | –                                  | –                  | F-A, S-I               | Category A<br>SW19       | –                | Electrical batteries containing lithium ion may react (e.g. flame, heat, emission of toxic, corrosive or flammable gases or vapours) or disassemble due to damage, defects or short circuit.                                     | 3481 △ |
| –      | T13                                | TP2<br>TP7<br>TP42 | F-G, S-N               | Category D<br>H1         | SG26<br>SG35     | Finely divided alkali or alkaline earth metal suspended in a flammable liquid. Reacts violently with moisture, water or acids, evolving hydrogen, which may be ignited by the heat of the reaction.                              | 3482 △ |
| –      | T14                                | TP2<br>TP13        | F-E, S-D               | Category D<br>SW1<br>SW2 | SGG7<br>SGG9     | Volatile flammable liquids evolving toxic vapour. Mixture of tetraethyllead or tetramethyllead with ethylene dibromide and ethylene dichloride. Insoluble in water. Highly toxic if swallowed, by skin contact or by inhalation. | 3483   |



Part 3 – Dangerous Goods List, special provisions and exceptions

Chapter 3.2 – Dangerous Goods List

| UN No. | Proper shipping name (PSN)   | Class or division | Subsidiary hazard(s) | Packing group  | Special provisions | Limited and excepted quantity provisions |                     | Packing      |              | IBC           |               |
|--------|--|-------------------|----------------------|----------------|--------------------|--|---------------------|--------------|--------------|---------------|---------------|
|        |  |                   |                      |                |                    | Limited quantities                       | Excepted quantities | Instructions | Provisions   | Instructions  | Provisions    |
| (1)    | (2)<br>3.1.2   | (3)<br>2.0        | (4)<br>2.0           | (5)<br>2.0.1.3 | (6)<br>3.3         | (7a)<br>3.4                              | (7b)<br>3.5         | (8)<br>4.1.4 | (9)<br>4.1.4 | (10)<br>4.1.4 | (11)<br>4.1.4 |
| 3484   | HYDRAZINE AQUEOUS SOLUTION, FLAMMABLE with more than 37% hydrazine, by mass  | 8                 | 3<br>6.1             | I              | –                  | 0  | E0                  | P001         | –            | –             | –             |
| 3485   | CALCIUM HYPOCHLORITE, DRY, CORROSIVE or CALCIUM HYPOCHLORITE MIXTURE, DRY, CORROSIVE with more than 39% available chlorine (8.8% available oxygen)   | 5.1               | 8<br>P               | II             | 314                | 1 kg                                     | E2                  | P002         | PP85         | –             | –             |
| 3486   | CALCIUM HYPOCHLORITE MIXTURE, DRY, CORROSIVE with more than 10% but not more than 39% available chlorine   | 5.1               | 8<br>P               | III            | 314                | 5 kg                                     | E1                  | P002         | PP85         | –             | –             |
| 3487   | CALCIUM HYPOCHLORITE, HYDRATED, CORROSIVE or CALCIUM HYPOCHLORITE, HYDRATED MIXTURE, CORROSIVE with not less than 5.5% but not more than 16% water   | 5.1               | 8<br>P               | II             | 314<br>322         | 1 kg                                     | E2                  | P002         | PP85         | –             | –             |
| 3487   | CALCIUM HYPOCHLORITE, HYDRATED, CORROSIVE or CALCIUM HYPOCHLORITE, HYDRATED MIXTURE, CORROSIVE with not less than 5.5% but not more than 16% water   | 5.1               | 8<br>P               | III            | 223<br>314         | 5 kg                                     | E1                  | P002         | PP85         | –             | –             |
| 3488   | TOXIC BY INHALATION LIQUID, FLAMMABLE, CORROSIVE, N.O.S. with an LC <sub>50</sub> lower than or equal to 200 mL/m <sup>3</sup> and saturated vapour concentration greater than or equal to 500 LC <sub>50</sub>      | 6.1               | 3<br>8               | I              | 274                | 0  | E0                  | P601         | –            | –             | –             |
| 3489   | TOXIC BY INHALATION LIQUID, FLAMMABLE, CORROSIVE, N.O.S. with an LC <sub>50</sub> lower than or equal to 1000 mL/m <sup>3</sup> and saturated vapour concentration greater than or equal to 10 LC <sub>50</sub>      | 6.1               | 3<br>8               | I              | 274                | 0  | E0                  | P602         | –            | –             | –             |
| 3490   | TOXIC BY INHALATION LIQUID, WATER-REACTIVE, FLAMMABLE, N.O.S. with an LC <sub>50</sub> lower than or equal to 200 mL/m <sup>3</sup> and saturated vapour concentration greater than or equal to 500 LC <sub>50</sub> | 6.1               | 4.3<br>3             | I              | 274                | 0  | E0                  | P601         | –            | –             | –             |

| UN No. | Portable tanks and bulk containers |               | EmS                    | Stowage and handling      | Segregation                                  | Properties and observations   | UN No. |
|--------|------------------------------------|---------------|------------------------|---------------------------|--|---|--------|
|        | Tank instructions                  | Provisions    |                        |                           |  |   |        |
| (12)   | (13)<br>4.2.5<br>4.3               | (14)<br>4.2.5 | (15)<br>5.4.3.4<br>7.8 | (16a)<br>7.1<br>7.3–7.7   | (16b)<br>7.2–7.7                             | (17)  | (18)   |
| –      | T10                                | TP2<br>TP13   | F-E, S-C               | Category D<br>SW2         | SGG18<br>SG5<br>SG8<br>SG35                  | Colourless flammable liquid. Powerful reducing agent, burns readily. Toxic if swallowed, by skin contact or by inhalation. Causes burns to skin, eyes and mucous membranes. Reacts violently with acids.  | 3484   |
| –      | –                                  | –             | F-H, S-Q               | Category D<br>SW1<br>SW11 | SGG8<br>SG35<br>SG38<br>SG49<br>SG53<br>SG60 | White or yellowish corrosive solid (powder, granules or tablets) with chlorine-like odour. Soluble in water. May cause fire in contact with organic material or ammonium compounds. Substances are liable to exothermic decomposition at elevated temperatures. This condition may lead to fire or explosion. Decomposition can be initiated by heat or by impurities (e.g. powdered metals (iron, manganese, cobalt, magnesium) and their compounds). Liable to heat slowly. Reacts with acids, evolving chlorine, an irritating, corrosive and toxic gas. In the presence of moisture, corrosive to most metals. Causes burns to skin, eyes and mucous membranes. | 3485   |
| –      | –                                  | –             | F-H, S-Q               | Category D<br>SW1<br>SW11 | SGG8<br>SG35<br>SG38<br>SG49<br>SG53<br>SG60 | White or yellowish corrosive solid (powder, granules or tablets) with chlorine-like odour. Soluble in water. May cause fire in contact with organic material or ammonium compounds. Substances are liable to exothermic decomposition at elevated temperatures. This condition may lead to fire or explosion. Decomposition can be initiated by heat or by impurities (e.g. powdered metals (iron, manganese, cobalt, magnesium) and their compounds). Liable to heat slowly. Reacts with acids, evolving chlorine, an irritating, corrosive and toxic gas. In the presence of moisture, corrosive to most metals. Causes burns to skin, eyes and mucous membranes. | 3486   |
| –      | –                                  | –             | F-H, S-Q               | Category D<br>SW1<br>SW11 | SGG8<br>SG35<br>SG38<br>SG49<br>SG53<br>SG60 | White or yellowish corrosive solid (powder, granules or tablets) with chlorine-like odour. Soluble in water. May cause fire in contact with organic material or ammonium compounds. Substances are liable to exothermic decomposition at elevated temperatures. This condition may lead to fire or explosion. Decomposition can be initiated by heat or by impurities (e.g. powdered metals (iron, manganese, cobalt, magnesium) and their compounds). Liable to heat slowly. Reacts with acids, evolving chlorine, an irritating, corrosive and toxic gas. In the presence of moisture, corrosive to most metals. Causes burns to skin, eyes and mucous membranes. | 3487   |
| –      | –                                  | –             | F-H, S-Q               | Category D<br>SW1<br>SW11 | SGG8<br>SG35<br>SG38<br>SG49<br>SG53<br>SG60 | See entry above.  | 3487   |
| –      | T22                                | TP2<br>TP13   | F-E, S-D               | Category D<br>SW2         | SG5<br>SG8                                   | A variety of toxic liquids which present a highly toxic inhalation hazard as well as being flammable and corrosive. Highly toxic if swallowed, by skin contact or by inhalation. Causes burns to skin, eyes and mucous membranes.   | 3488   |
| –      | T20                                | TP2<br>TP13   | F-E, S-D               | Category D<br>SW2         | SG5<br>SG8                                   | A variety of toxic liquids which present a highly toxic inhalation hazard as well as being flammable and corrosive. Highly toxic if swallowed, by skin contact or by inhalation. Causes burns to skin, eyes and mucous membranes.   | 3489   |
| –      | T22                                | TP2<br>TP13   | F-G, S-N               | Category D<br>SW2<br>H1   | SG5<br>SG13<br>SG25<br>SG26                  | A variety of toxic liquids which present a highly toxic inhalation hazard as well as being water-reactive and flammable. Highly toxic if swallowed, by skin contact or by inhalation.   | 3490   |

Part 3 – Dangerous Goods List, special provisions and exceptions

Chapter 3.2 – Dangerous Goods List

| UN No. | Proper shipping name (PSN)   | Class or division | Subsidiary hazard(s) | Packing group  | Special provisions | Limited and excepted quantity provisions |                     | Packing      |              | IBC           |               |
|--------|--|-------------------|----------------------|----------------|--------------------|--|---------------------|--------------|--------------|---------------|---------------|
|        |  |                   |                      |                |                    | Limited quantities                       | Excepted quantities | Instructions | Provisions   | Instructions  | Provisions    |
| (1)    | (2)<br>3.1.2   | (3)<br>2.0        | (4)<br>2.0           | (5)<br>2.0.1.3 | (6)<br>3.3         | (7a)<br>3.4                              | (7b)<br>3.5         | (8)<br>4.1.4 | (9)<br>4.1.4 | (10)<br>4.1.4 | (11)<br>4.1.4 |
| 3491   | TOXIC BY INHALATION LIQUID, WATER-REACTIVE, FLAMMABLE, N.O.S. with an LC <sub>50</sub> lower than or equal to 1000 mL/m <sup>3</sup> and saturated vapour concentration greater than or equal to 10 LC <sub>50</sub> | 6.1               | 4.3<br>3             | I              | 274                | 0  | E0                  | P602         | -            | -             | -             |
| 3494   | PETROLEUM SOUR CRUDE OIL, FLAMMABLE, TOXIC   | 3                 | 6.1                  | I              | 343                | 0  | E0                  | P001         | -            | -             | -             |
| 3494   | PETROLEUM SOUR CRUDE OIL, FLAMMABLE, TOXIC   | 3                 | 6.1                  | II             | 343                | 1 L                                      | E2                  | P001         | -            | IBC02         | -             |
| 3494   | PETROLEUM SOUR CRUDE OIL, FLAMMABLE, TOXIC   | 3                 | 6.1                  | III            | 343                | 5 L                                      | E1                  | P001         | -            | IBC03         | -             |
| 3495   | IODINE   | 8                 | 6.1                  | III            | 279                | 5 kg                                     | E1                  | P002         | -            | IBC08         | B3            |
| 3496   | BATTERIES, NICKEL-METAL HYDRIDE  | 9                 | -                    | -              | 117<br>963         | 0  | E0                  | See SP963    | -            | IBC08         | -             |
| 3497   | KRILL MEAL   | 4.2               | -                    | II             | 300                | 0  | E2                  | P410         | -            | IBC06         | B21           |
| 3497   | KRILL MEAL   | 4.2               | -                    | III            | 223<br>300         | 0  | E1                  | P002<br>LP02 | -            | IBC08         | B3            |
| 3498   | IODINE MONOCHLORIDE, LIQUID  | 8                 | -                    | II             | -                  | 1 L                                      | E0                  | P001         | -            | IBC02         | -             |
| 3499   | CAPACITOR, ELECTRIC DOUBLE LAYER (with an energy storage capacity greater than 0.3 Wh)   | 9                 | -                    | -              | 361                | 0  | E0                  | P003         | -            | -             | -             |
| 3500   | CHEMICAL UNDER PRESSURE, N.O.S.  | 2.2               | -                    | -              | 274<br>362         | 0  | E0                  | P206         | PP97         | -             | -             |
| 3501   | CHEMICAL UNDER PRESSURE, FLAMMABLE, N.O.S.   | 2.1               | -                    | -              | 274<br>362         | 0  | E0                  | P206         | PP89         | -             | -             |
| 3502   | CHEMICAL UNDER PRESSURE, TOXIC, N.O.S.   | 2.2               | 6.1                  | -              | 274<br>362         | 0  | E0                  | P206         | PP89         | -             | -             |
| 3503   | CHEMICAL UNDER PRESSURE, CORROSIVE, N.O.S.   | 2.2               | 8                    | -              | 274<br>362         | 0  | E0                  | P206         | PP89         | -             | -             |
| 3504   | CHEMICAL UNDER PRESSURE, FLAMMABLE, TOXIC, N.O.S.  | 2.1               | 6.1                  | -              | 274<br>362         | 0  | E0                  | P206         | PP89         | -             | -             |
| 3505   | CHEMICAL UNDER PRESSURE, FLAMMABLE, CORROSIVE, N.O.S.  | 2.1               | 8                    | -              | 274<br>362         | 0  | E0                  | P206         | PP89         | -             | -             |
| △ 3506 | MERCURY CONTAINED IN MANUFACTURED ARTICLES   | 8                 | 6.1                  | -              | 366                | 5 kg                                     | E0                  | P003         | PP90         | -             | -             |

| UN No. | Portable tanks and bulk containers |               | EmS                    | Stowage and handling    | Segregation   | Properties and observations  | UN No. |
|--------|------------------------------------|---------------|------------------------|-------------------------|---|--|--------|
|        | Tank instructions                  | Provisions    |                        |                         |   |  |        |
| (12)   | (13)<br>4.2.5<br>4.3               | (14)<br>4.2.5 | (15)<br>5.4.3.4<br>7.8 | (16a)<br>7.1<br>7.3-7.7 | (16b)<br>7.2-7.7                                    | (17)   | (18)   |
| -      | T20                                | TP2<br>TP13   | F-G, S-N               | Category D<br>SW2<br>H1 | SG5<br>SG13<br>SG25<br>SG26                         | A variety of toxic liquids which present a highly toxic inhalation hazard as well as being water-reactive and flammable. Highly toxic if swallowed, by skin contact or by inhalation.  | 3491   |
| -      | T14                                | TP2<br>TP13   | F-E, S-E               | Category D<br>SW2       | -   | Immiscible with water. Evolves hydrogen sulphide, which is a flammable, toxic gas with a foul odour, heavier than air (1.2). Toxic if swallowed, by skin contact or by inhalation.   | 3494   |
| -      | T7                                 | TP2           | F-E, S-E               | Category D<br>SW2       | -   | See entry above.   | 3494   |
| -      | T4                                 | TP1           | F-E, S-E               | Category C<br>SW2       | -   | See entry above.   | 3494   |
| -      | T1                                 | TP33          | F-A, S-B               | Category B<br>SW2       | SG37  | Bluish-black solid with a metallic lustre and a pungent odour. Melting point: 114°C. Below its melting point, may evolve vapours which are irritating to skin, eyes and mucous membranes. Slightly soluble in water but soluble in most organic solvents. Corrosive to most metals.                          | 3495   |
| -      | -                                  | -             | F-A, S-I               | Category A<br>SW1       | -   | Nickel-metal hydride cells or batteries packed with or contained in equipment and nickel-metal hydride button cells are not subject to the provisions of this Code.  | 3496   |
| -      | T3                                 | TP33          | F-A, S-J               | Category B<br>SW27      | SG65  | Pink to red meal derived from Krill which is a shrimp-like marine organism. Medium odour, which may affect other sensitive cargo. Liable to self-heating. Naturally rich in anti-oxidants, which lessen the risk of spontaneous heating.   | 3497   |
| -      | T1                                 | TP33          | F-A, S-J               | Category A              | -   | See entry above.   | 3497   |
| -      | T7                                 | TP2           | F-A, S-B               | Category D<br>SW2       | SGG1<br>SG6<br>SG16<br>SG17<br>SG19<br>SG36<br>SG49 | Red Liquid. Reacts violently with water, evolving irritating and corrosive gases apparent as white fumes. Powerful oxidant: may cause fire in contact with organic materials such as wood, cotton or straw. In the presence of moisture, highly corrosive to most metals. Vapour irritates mucous membranes. | 3498   |
| -      | -                                  | -             | F-A, S-I               | Category A              | -   | Articles intended to store energy containing a non-dangerous activated carbon and an electrolyte. Electric double layer capacitors installed in equipment may be transported in a charged state.   | 3499   |
| -      | T50                                | TP4<br>TP40   | F-C, S-V               | Category B              | -   | Liquids, pastes or powders, pressurized with a propellant which meets the definition of a gas.   | 3500   |
| -      | T50                                | TP4<br>TP40   | F-D, S-U               | Category D<br>SW2       | -   | Liquids, pastes or powders, pressurized with a propellant which meets the definition of a gas.   | 3501   |
| -      | T50                                | TP4<br>TP40   | F-C, S-V               | Category D<br>SW2       | -   | Liquids, pastes or powders, pressurized with a propellant which meets the definition of a gas.   | 3502   |
| -      | T50                                | TP4<br>TP40   | F-C, S-V               | Category D<br>SW2       | -   | Liquids, pastes or powders, pressurized with a propellant which meets the definition of a gas.   | 3503   |
| -      | T50                                | TP4<br>TP40   | F-D, S-U               | Category D<br>SW2       | -   | Liquids, pastes or powders, pressurized with a propellant which meets the definition of a gas.   | 3504   |
| -      | T50                                | TP4<br>TP40   | F-D, S-U               | Category D<br>SW2       | -   | Liquids, pastes or powders, pressurized with a propellant which meets the definition of a gas.   | 3505   |
| -      | -                                  | -             | F-A, S-B               | Category B<br>SW2       | SG24  | Mercury (UN 2809) is highly corrosive to aluminium. Carriage should be prohibited in hovercraft and other ships constructed with aluminium.  | △ 3506 |



Part 3 – Dangerous Goods List, special provisions and exceptions

Chapter 3.2 – Dangerous Goods List

| UN No. | Proper shipping name (PSN)  | Class or division | Subsidiary hazard(s) | Packing group  | Special provisions | Limited and excepted quantity provisions |                     | Packing      |              | IBC           |               |
|--------|---|-------------------|----------------------|----------------|--------------------|--|---------------------|--------------|--------------|---------------|---------------|
|        |   |                   |                      |                |                    | Limited quantities                       | Excepted quantities | Instructions | Provisions   | Instructions  | Provisions    |
| (1)    | (2)<br>3.1.2  | (3)<br>2.0        | (4)<br>2.0           | (5)<br>2.0.1.3 | (6)<br>3.3         | (7a)<br>3.4                              | (7b)<br>3.5         | (8)<br>4.1.4 | (9)<br>4.1.4 | (10)<br>4.1.4 | (11)<br>4.1.4 |
| 3507   | URANIUM HEXAFLUORIDE, RADIOACTIVE MATERIAL, EXCEPTED PACKAGE, less than 0.1 kg per package, non-fissile or fissile-excepted | 6.1               | 7/8                  | I              | 317<br>369         | 0  | E0                  | P603         | -            | -             | -             |
| 3508   | CAPACITOR, ASYMMETRIC (with an energy storage capacity greater than 0.3Wh)  | 9                 | -                    | -              | 372                | 0  | E0                  | P003         | -            | -             | -             |
| 3509   | PACKAGINGS, DISCARDED, EMPTY, UNCLEANED   | 9                 | -                    | -              | 968                | 0  | E0                  | -            | -            | -             | -             |
| 3510   | ADSORBED GAS, FLAMMABLE, N.O.S.   | 2.1               | -                    | -              | 274                | 0  | E0                  | P208         | -            | -             | -             |
| 3511   | ADSORBED GAS, N.O.S.  | 2.2               | -                    | -              | 274                | 0  | E0                  | P208         | -            | -             | -             |
| 3512   | ADSORBED GAS, TOXIC, N.O.S.   | 2.3               | -                    | -              | 274                | 0  | E0                  | P208         | -            | -             | -             |
| 3513   | ADSORBED GAS, OXIDIZING, N.O.S.   | 2.2               | 5.1                  | -              | 274                | 0  | E0                  | P208         | -            | -             | -             |
| 3514   | ADSORBED GAS, TOXIC, FLAMMABLE, N.O.S.  | 2.3               | 2.1                  | -              | 274                | 0  | E0                  | P208         | -            | -             | -             |
| 3515   | ADSORBED GAS, TOXIC, OXIDIZING, N.O.S.  | 2.3               | 5.1                  | -              | 274                | 0  | E0                  | P208         | -            | -             | -             |
| 3516   | ADSORBED GAS, TOXIC, CORROSIVE, N.O.S.  | 2.3               | 8                    | -              | 274<br>379         | 0  | E0                  | P208         | -            | -             | -             |
| 3517   | ADSORBED GAS, TOXIC, FLAMMABLE, CORROSIVE, N.O.S.   | 2.3               | 2.1<br>8             | -              | 274                | 0  | E0                  | P208         | -            | -             | -             |
| 3518   | ADSORBED GAS, TOXIC, OXIDIZING, CORROSIVE, N.O.S.   | 2.3               | 5.1<br>8             | -              | 274                | 0  | E0                  | P208         | -            | -             | -             |
| 3519   | BORON TRIFLUORIDE, ADSORBED   | 2.3               | 8                    | -              | -                  | 0  | E0                  | P208         | -            | -             | -             |
| 3520   | CHLORINE, ADSORBED  | 2.3               | 5.1<br>8             | -              | -                  | 0  | E0                  | P208         | -            | -             | -             |
| 3521   | SILICON TETRAFLUORIDE, ADSORBED   | 2.3               | 8                    | -              | -                  | 0  | E0                  | P208         | -            | -             | -             |
| 3522   | ARSINE, ADSORBED  | 2.3               | 2.1                  | -              | -                  | 0  | E0                  | P208         | -            | -             | -             |
| 3523   | GERMANE, ADSORBED   | 2.3               | 2.1                  | -              | -                  | 0  | E0                  | P208         | -            | -             | -             |
| 3524   | PHOSPHORUS PENTAFLUORIDE, ADSORBED  | 2.3               | 8                    | -              | -                  | 0  | E0                  | P208         | -            | -             | -             |

| UN No. | Portable tanks and bulk containers |               | EmS                    | Stowage and handling    | Segregation      | Properties and observations   | UN No. |
|--------|------------------------------------|---------------|------------------------|-------------------------|------------------|---|--------|
|        | Tank instructions                  | Provisions    |                        |                         |                  |   |        |
| (12)   | (13)<br>4.2.5<br>4.3               | (14)<br>4.2.5 | (15)<br>5.4.3.4<br>7.8 | (16a)<br>7.1<br>7.3-7.7 | (16b)<br>7.2-7.7 | (17)  | (18)   |
| -      | -                                  | -             | F-I, S-S               | Category A<br>SW12      | SG77             | See 1.5.1.  | 3507   |
| -      | -                                  | -             | F-A, S-I               | Category A              | -                | Articles intended to store energy containing positive and negative electrodes comprised of different materials and an electrolyte. Asymmetric capacitors may be transported in a charged state.   | 3508   |
| -      | -                                  | -             | -                      | -                       | -                | This entry shall not be used for sea transport. Discarded packaging shall meet the requirements of 4.1.1.11. Discarded packaging means packagings, large packagings or intermediate bulk containers (IBC), or parts thereof, which have contained dangerous goods, other than radioactive material, which are transported for disposal, recycling or recovery of their material, other than reconditioning, repair, routine maintenance, remanufacturing or reuse, and which have been emptied to the extent that only residues of dangerous goods adhering to the packaging parts are present. | 3509   |
| -      | -                                  | -             | F-D, S-U               | Category D<br>SW2       | -                | -   | 3510   |
| -      | -                                  | -             | F-C, S-V               | Category A              | -                | -   | 3511   |
| -      | -                                  | -             | F-C, S-U               | Category D<br>SW2       | -                | -   | 3512   |
| -      | -                                  | -             | F-C, S-W               | Category D              | -                | -   | 3513   |
| -      | -                                  | -             | F-D, S-U               | Category D<br>SW2       | -                | -   | 3514   |
| -      | -                                  | -             | F-C, S-W               | Category D<br>SW2       | -                | -   | 3515   |
| -      | -                                  | -             | F-C, S-U               | Category D<br>SW2       | -                | -   | 3516   |
| -      | -                                  | -             | F-D, S-U               | Category D<br>SW2       | SG4<br>SG9       | -   | 3517   |
| -      | -                                  | -             | F-C, S-W               | Category D<br>SW2       | SG6<br>SG19      | -   | 3518   |
| -      | -                                  | -             | F-C, S-U               | Category D<br>SW2       | -                | Non-flammable, toxic and corrosive gas. Forms dense white corrosive fumes in moist air. Reacts violently with water, evolving hydrogen fluoride, an irritating and corrosive gas apparent as white fumes. In the presence of moisture, highly corrosive to glass and most metals. Much heavier than air (2.35). Highly irritating to skin, eyes and mucous membranes.   | 3519   |
| -      | -                                  | -             | F-C, S-W               | Category D<br>SW2       | SG6<br>SG19      | Non-flammable, toxic and corrosive yellow gas with a pungent odour. Corrosive to glass and to most metals. Much heavier than air (2.4). Highly irritating to skin, eyes and mucous membranes. Powerful oxidant which may cause fire.  | 3520   |
| -      | -                                  | -             | F-C, S-U               | Category D<br>SW2       | -                | Non-flammable, toxic and corrosive gas with a pungent odour. Corrosive to metals. In moist air, produces hydrogen fluoride. Much heavier than air (3.6). Highly irritating to skin, eyes and mucous membranes.  | 3521   |
| -      | -                                  | -             | F-D, S-U               | Category D<br>SW2       | -                | Flammable, toxic, colourless gas with a garlic odour. Explosive limits: 3.9% to 77.8%. Much heavier than air (2.8).   | 3522   |
| -      | -                                  | -             | F-D, S-U               | Category D<br>SW2       | -                | Flammable, toxic, colourless gas with a pungent odour. Much heavier than air (2.6).   | 3523   |
| -      | -                                  | -             | F-C, S-U               | Category D<br>SW2       | -                | Non-flammable, toxic and corrosive gas with an irritating odour. Reacts with water or moist air to produce toxic and corrosive fumes. Corrosive to glass and to most metals. Much heavier than air (4.3). Highly irritating to skin, eyes and mucous membranes.   | 3524   |

Part 3 – Dangerous Goods List, special provisions and exceptions

Chapter 3.2 – Dangerous Goods List

| UN No. | Proper shipping name (PSN)   | Class or division | Subsidiary hazard(s) | Packing group  | Special provisions | Limited and excepted quantity provisions |                     | Packing      |              | IBC           |               |
|--------|--|-------------------|----------------------|----------------|--------------------|--|---------------------|--------------|--------------|---------------|---------------|
|        |  |                   |                      |                |                    | Limited quantities                       | Excepted quantities | Instructions | Provisions   | Instructions  | Provisions    |
| (1)    | (2)<br>3.1.2   | (3)<br>2.0        | (4)<br>2.0           | (5)<br>2.0.1.3 | (6)<br>3.3         | (7a)<br>3.4                              | (7b)<br>3.5         | (8)<br>4.1.4 | (9)<br>4.1.4 | (10)<br>4.1.4 | (11)<br>4.1.4 |
| 3525   | PHOSPHINE, ADSORBED  | 2.3               | 2.1                  | -              | -                  | 0  | E0                  | P208         | -            | -             | -             |
| 3526   | HYDROGEN SELENIDE, ADSORBED  | 2.3               | 2.1                  | -              | -                  | 0  | E0                  | P208         | -            | -             | -             |
| 3527   | POLYESTER RESIN KIT, solid base material   | 4.1               | -                    | II             | 236<br>340         | 5kg                                      | See SP340           | P412         | -            | -             | -             |
| 3527   | POLYESTER RESIN KIT, solid base material   | 4.1               | -                    | III            | 236<br>340         | 5kg                                      | See SP340           | P412         | -            | -             | -             |
| 3528   | ENGINE, INTERNAL COMBUSTION, FLAMMABLE LIQUID POWERED or ENGINE, FUEL CELL, FLAMMABLE LIQUID POWERED or MACHINERY, INTERNAL COMBUSTION, FLAMMABLE LIQUID POWERED or MACHINERY, FUEL CELL, FLAMMABLE LIQUID POWERED | 3                 | -                    | -              | 363<br>972         | 0  | E0                  | P005         | -            | -             | -             |
| 3529   | ENGINE, INTERNAL COMBUSTION, FLAMMABLE GAS POWERED or ENGINE, FUEL CELL, FLAMMABLE GAS POWERED or MACHINERY, INTERNAL COMBUSTION, FLAMMABLE GAS POWERED or MACHINERY, FUEL CELL, FLAMMABLE GAS POWERED             | 2.1               | -                    | -              | 356<br>363<br>972  | 0  | E0                  | P005         | -            | -             | -             |
| 3530   | ENGINE, INTERNAL COMBUSTION or MACHINERY, INTERNAL COMBUSTION  | 9                 | -<br>P               | -              | 363<br>972         | 0  | E0                  | P005         | -            | -             | -             |
| 3531   | POLYMERIZING SUBSTANCE, SOLID, STABILIZED, N.O.S.  | 4.1               | -                    | III            | 274<br>386         | 0  | E0                  | P002         | PP92         | IBC07         | B18           |
| 3532   | POLYMERIZING SUBSTANCE, LIQUID, STABILIZED, N.O.S.   | 4.1               | -                    | III            | 274<br>386         | 0  | E0                  | P001         | PP93         | IBC03         | B19           |
| 3533   | POLYMERIZING SUBSTANCE, SOLID, TEMPERATURE CONTROLLED, N.O.S.  | 4.1               | -                    | III            | 274<br>386         | 0  | E0                  | P002         | PP92         | IBC07         | B18           |
| 3534   | POLYMERIZING SUBSTANCE, LIQUID, TEMPERATURE CONTROLLED, N.O.S.   | 4.1               | -                    | III            | 274<br>386         | 0  | E0                  | P001         | PP93         | IBC03         | B19           |
| 3535   | TOXIC SOLID, FLAMMABLE, INORGANIC, N.O.S.  | 6.1               | 4.1                  | I              | 274                | 0  | E5                  | P002         | -            | IBC99         | -             |
| 3535   | TOXIC SOLID, FLAMMABLE, INORGANIC, N.O.S.  | 6.1               | 4.1                  | II             | 274                | 500 g                                    | E4                  | P002         | -            | IBC08         | B4<br>B21     |

| UN No. | Portable tanks and bulk containers |                    | EmS                    | Stowage and handling    | Segregation      | Properties and observations   | UN No. |
|--------|------------------------------------|--------------------|------------------------|-------------------------|------------------|---|--------|
|        | Tank instructions                  | Provisions         |                        |                         |                  |   |        |
| (12)   | (13)<br>4.2.5<br>4.3               | (14)<br>4.2.5      | (15)<br>5.4.3.4<br>7.8 | (16a)<br>7.1<br>7.3-7.7 | (16b)<br>7.2-7.7 | (17)  | (18)   |
| -      | -                                  | -                  | F-D, S-U               | Category D SW2          | -                | Flammable, toxic, colourless gas with a garlic odour. Ignites spontaneously in air. Heavier than air (1.2). Irritating to skin, eyes and mucous membranes.  | 3525   |
| -      | -                                  | -                  | F-D, S-U               | Category D SW2          | -                | Flammable, toxic, colourless gas with a disagreeable odour. Much heavier than air (2.8). Highly irritating to skin, eyes and mucous membranes.  | 3526   |
| -      | -                                  | -                  | F-A, S-G               | Category B              | -                | Polyester resin kits consist of two components: a base material (flammable solid) and an activator (organic peroxide), each separately packed in an inner packaging.  | 3527   |
| -      | -                                  | -                  | F-A, S-G               | Category B              | -                | See entry above.  | 3527   |
| -      | -                                  | -                  | F-E, S-E               | Category E SW29         | -                | Types of articles transported under this entry include engines or machinery, powered by fuels classified as dangerous goods via internal combustion systems or fuel cells (e.g. combustion engines, generators, compressors, turbines, heating units, etc.).  | 3528   |
| -      | -                                  | -                  | F-D, S-U               | Category E              | -                | Types of articles transported under this entry include engines or machinery, powered by fuels classified as dangerous goods via internal combustion systems or fuel cells (e.g. combustion engines, generators, compressors, turbines, heating units, etc.).  | 3529   |
| -      | -                                  | -                  | F-A, S-F               | Category A              | -                | Types of articles transported under this entry include engines or machinery, powered by fuels classified as dangerous goods via internal combustion systems (e.g. combustion engines, generators, compressors, turbines, heating units, etc.).  | 3530   |
| -      | T7                                 | TP4<br>TP6<br>TP33 | F-J, S-G               | Category D SW1          | SG35<br>SG36     | Polymerizes at elevated temperatures or in a fire. Burns vigorously. Insoluble in water. Contact with alkalis or acids may cause dangerous polymerization. The products of combustion or self-accelerating polymerization may be toxic by inhalation.   | 3531   |
| -      | T7                                 | TP4<br>TP6         | F-J, S-G               | Category D SW1          | SG35<br>SG36     | Polymerizes at elevated temperatures or in a fire. Burns vigorously. Immiscible with water. Contact with alkalis or acids may cause dangerous polymerization. The products of combustion or self-accelerating polymerization may be toxic by inhalation.  | 3532   |
| -      | T7                                 | TP4<br>TP6<br>TP33 | F-F, S-K               | Category D SW1<br>SW3   | SG35<br>SG36     | Polymerizes at temperatures higher than the self-accelerating polymerization temperature or in a fire. Burns vigorously. Insoluble in water. Contact with alkalis or acids may cause dangerous polymerization. The products of combustion or self-accelerating polymerization may be toxic by inhalation. Control and emergency temperatures can be found in the transport document as required in 5.4.1.5.5. The temperature must be checked regularly.    | 3533   |
| -      | T7                                 | TP4<br>TP6         | F-F, S-K               | Category D SW1<br>SW3   | SG35<br>SG36     | Polymerizes at temperatures higher than the self-accelerating polymerization temperature or in a fire. Burns vigorously. Immiscible with water. Contact with alkalis or acids may cause dangerous polymerization. The products of combustion or self-accelerating polymerization may be toxic by inhalation. Control and emergency temperatures can be found in the transport document as required in 5.4.1.5.5. The temperature must be checked regularly. | 3534   |
| -      | T6                                 | TP33               | F-A, S-G               | Category B              | -                | Toxic if swallowed, by skin contact or by dust inhalation.  | 3535   |
| -      | T3                                 | TP33               | F-A, S-G               | Category B              | -                | See entry above.  | 3535   |

Part 3 – Dangerous Goods List, special provisions and exceptions

Chapter 3.2 – Dangerous Goods List

| UN No. | Proper shipping name (PSN)   | Class or division | Subsidiary hazard(s) | Packing group  | Special provisions  | Limited and excepted quantity provisions |                     | Packing  |              | IBC           |               |
|--------|--|-------------------|----------------------|----------------|---|--|---------------------|--|--------------|---------------|---------------|
|        |  |                   |                      |                |   | Limited quantities                       | Excepted quantities | Instructions   | Provisions   | Instructions  | Provisions    |
| (1)    | (2)<br>3.1.2   | (3)<br>2.0        | (4)<br>2.0           | (5)<br>2.0.1.3 | (6)<br>3.3  | (7a)<br>3.4                              | (7b)<br>3.5         | (8)<br>4.1.4   | (9)<br>4.1.4 | (10)<br>4.1.4 | (11)<br>4.1.4 |
| △ 3536 | LITHIUM BATTERIES INSTALLED IN CARGO TRANSPORT UNIT lithium ion batteries or lithium metal batteries           | 9                 | -                    | -              | 389   | 0  | E0                  | -  | -            | -             | -             |
| △ 3537 | ARTICLES CONTAINING FLAMMABLE GAS, N.O.S.  | 2.1               | See 2.0.6.6          | -              | 274<br>310<br>391   | 0  | E0                  | P006<br>LP03   | -            | -             | -             |
| △ 3538 | ARTICLES CONTAINING NON-FLAMMABLE, NON-TOXIC GAS, N.O.S.   | 2.2               | See 2.0.6.6          | -              | 274<br>310<br>391<br>396                                    | 0  | E0                  | P006<br>LP03   | -            | -             | -             |
| 3539   | ARTICLES CONTAINING TOXIC GAS, N.O.S.  | 2.3               | See 2.0.6.6          | -              | 274<br>391  | 0  | E0                  | -  | -            | -             | -             |
| △ 3540 | ARTICLES CONTAINING FLAMMABLE LIQUID, N.O.S.   | 3                 | See 2.0.6.6          | -              | 274<br>310<br>391   | 0  | E0                  | P006<br>LP03   | -            | -             | -             |
| △ 3541 | ARTICLES CONTAINING FLAMMABLE SOLID, N.O.S.  | 4.1               | See 2.0.6.6          | -              | 274<br>310<br>391   | 0  | E0                  | P006<br>LP03   | -            | -             | -             |
| 3542   | ARTICLES CONTAINING A SUBSTANCE LIABLE TO SPONTANEOUS COMBUSTION, N.O.S.                                       | 4.2               | See 2.0.6.6          | -              | 274<br>391  | 0  | E0                  | -  | -            | -             | -             |
| 3543   | ARTICLES CONTAINING A SUBSTANCE WHICH IN CONTACT WITH WATER EMITS FLAMMABLE GASES, N.O.S.                      | 4.3               | See 2.0.6.6          | -              | 274<br>391  | 0  | E0                  | -  | -            | -             | -             |
| 3544   | ARTICLES CONTAINING OXIDIZING SUBSTANCE, N.O.S.  | 5.1               | See 2.0.6.6          | -              | 274<br>391  | 0  | E0                  | -  | -            | -             | -             |
| 3545   | ARTICLES CONTAINING ORGANIC PEROXIDE, N.O.S.   | 5.2               | See 2.0.6.6          | -              | 274<br>391  | 0  | E0                  | -  | -            | -             | -             |
| △ 3546 | ARTICLES CONTAINING TOXIC SUBSTANCE, N.O.S.  | 6.1               | See 2.0.6.6          | -              | 274<br>310<br>391   | 0  | E0                  | P006<br>LP03   | -            | -             | -             |
| △ 3547 | ARTICLES CONTAINING CORROSIVE SUBSTANCE, N.O.S.  | 8                 | See 2.0.6.6          | -              | 274<br>310<br>391   | 0  | E0                  | P006<br>LP03   | -            | -             | -             |
| △ 3548 | ARTICLES CONTAINING MISCELLANEOUS DANGEROUS GOODS, N.O.S.  | 9                 | See 2.0.6.6          | -              | 274<br>310<br>391   | 0  | E0                  | P006<br>LP03   | -            | -             | -             |
| 3549   | MEDICAL WASTE, CATEGORY A, AFFECTING HUMANS, solid or MEDICAL WASTE, CATEGORY A, AFFECTING ANIMALS only, solid | 6.2               | -                    | -              | 395<br>975  | 0  | E0                  | P622<br>LP622  | -            | -             | -             |
| 3550   | COBALT DIHYDROXIDE POWDER, containing not less than 10% respirable particles                                   | 6.1               | P                    | I              | -   | 0  | E5                  | P002   | -            | IBC07         | B1<br>B40     |
| ■ 3551 | SODIUM ION BATTERIES with organic electrolyte  | 9                 | -                    | -              | 188<br>230<br>310<br>348<br>376<br>377<br>384<br>400<br>401 | 0  | E0                  | P903<br>P908<br>P909<br>P910<br>P911<br>LP903<br>LP904<br>LP905<br>LP906 | -            | -             | -             |

| UN No. | Portable tanks and bulk containers |               | EmS                    | Stowage and handling          | Segregation      | Properties and observations  | UN No. |
|--------|------------------------------------|---------------|------------------------|-------------------------------|------------------|--|--------|
|        | Tank instructions                  | Provisions    |                        |                               |                  |  |        |
| (12)   | (13)<br>4.2.5<br>4.3               | (14)<br>4.2.5 | (15)<br>5.4.3.4<br>7.8 | (16a)<br>7.1<br>7.3-7.7       | (16b)<br>7.2-7.7 | (17)   | (18)   |
| -      | -                                  | -             | F-A, S-I               | Category D<br>SW1<br>SW2      | -                | Cargo transport unit containing lithium metal or lithium ion batteries which is designed to serve as mobile power supply unit.   | 3536 △ |
| -      | -                                  | -             | F-D, S-U               | Category D<br>SW2             | -                | -  | 3537 △ |
| -      | -                                  | -             | F-C, S-V               | Category A                    | -                | -  | 3538 △ |
| -      | -                                  | -             | F-C, S-U               | -                             | -                | -  | 3539   |
| -      | -                                  | -             | F-E, S-D               | Category B                    | -                | -  | 3540 △ |
| -      | -                                  | -             | F-A, S-G               | Category B                    | -                | -  | 3541 △ |
| -      | -                                  | -             | *                      | -                             | -                | * F-G, S-M for pyrophoric substances, F-A, S-J for self-heating substances   | 3542   |
| -      | -                                  | -             | F-G, S-N               | -                             | -                | -  | 3543   |
| -      | -                                  | -             | F-A, S-Q               | -                             | -                | -  | 3544   |
| -      | -                                  | -             | F-J, S-R               | -                             | -                | -  | 3545   |
| -      | -                                  | -             | F-A, S-A               | Category B<br>SW2<br>*        | -                | Toxic if swallowed, by skin contact or by dust inhalation.<br>* When competent authority approval is required by SP391, the stowage and handling will be specified by the competent authority. | 3546 △ |
| -      | -                                  | -             | F-A, S-B               | Category B<br>SW2             | -                | Causes burns to skin, eyes and mucous membranes.   | 3547 △ |
| -      | -                                  | -             | F-A, S-P               | Category A                    | -                | -  | 3548 △ |
| -      | -                                  | -             | F-A, S-T               | Category E<br>SW2<br>H1<br>H5 | SG50             | Waste containing substances which are dangerous to humans and/or animals.  | 3549   |
| -      | T6                                 | TP33          | F-A, S-A               | Category D<br>SW2             | -                | Pink odourless powder. Toxic by dust inhalation.   | 3550   |
| -      | -                                  | -             | F-A, S-I               | Category A<br>SW19            | -                | Electrical batteries containing sodium ion may react (e.g. flame, heat, emission of toxic, corrosive or flammable gases or vapours) or disassemble due to damage, defects or short circuit.    | 3551 ■ |

Part 3 – Dangerous Goods List, special provisions and exceptions

Chapter 3.2 – Dangerous Goods List

| UN No. | Proper shipping name (PSN)  | Class or division | Subsidiary hazard(s) | Packing group  | Special provisions   | Limited and excepted quantity provisions |                     | Packing  |              | IBC           |               |   |
|--------|---|-------------------|----------------------|----------------|--|--|---------------------|--|--------------|---------------|---------------|---|
|        |   |                   |                      |                |  | Limited quantities                       | Excepted quantities | Instructions   | Provisions   | Instructions  | Provisions    |   |
| (1)    | (2)<br>3.1.2  | (3)<br>2.0        | (4)<br>2.0           | (5)<br>2.0.1.3 | (6)<br>3.3   | (7a)<br>3.4                              | (7b)<br>3.5         | (8)<br>4.1.4   | (9)<br>4.1.4 | (10)<br>4.1.4 | (11)<br>4.1.4 |   |
| 3552   | SODIUM ION BATTERIES CONTAINED IN EQUIPMENT or SODIUM ION BATTERIES PACKED WITH EQUIPMENT, with organic electrolyte | 9                 | -                    | -              | 188<br>230<br>310<br>348<br>360<br>376<br>377<br>384<br>400<br>401 | 0  | E0                  | P903<br>P908<br>P909<br>P910<br>P911<br>LP903<br>LP904<br>LP905<br>LP906 | -            | -             | -             | - |
| 3553   | DISILANE  | 2.1               | -                    | -              | -  | 0  | E0                  | P200   | -            | -             | -             |   |
| 3554   | GALLIUM CONTAINED IN MANUFACTURED ARTICLES  | 8                 | -                    | -              | 366  | 5 kg                                     | E0                  | P003   | PP90         | -             | -             |   |
| 3555   | TRIFLUOROMETHYL-TETRAZOLESODIUM SALT IN ACETONE, with not less than 68% acetone, by mass                            | 3                 | -                    | II             | 28   | 0  | E0                  | P303   | PP26         | -             | -             |   |
| 3556   | VEHICLE, LITHIUM ION BATTERY POWERED  | 9                 | -                    | -              | 384<br>388<br>405<br>961<br>962                                    | 0  | E0                  | P912   | -            | -             | -             |   |
| 3557   | VEHICLE, LITHIUM METAL BATTERY POWERED  | 9                 | -                    | -              | 384<br>388<br>405<br>961<br>962                                    | 0  | E0                  | P912   | -            | -             | -             |   |
| 3558   | VEHICLE, SODIUM ION BATTERY POWERED   | 9                 | -                    | -              | 384<br>388<br>404<br>405<br>961<br>962<br>977                      | 0  | E0                  | P912   | -            | -             | -             |   |
| 3559   | FIRE SUPPRESSANT DISPERSING DEVICES   | 9                 | -                    | -              | 407  | 0  | E0                  | P902   | -            | -             | -             |   |
| 3560   | TETRAMETHYLAMMONIUM HYDROXIDE AQUEOUS SOLUTION with not less than 25% tetramethylammonium hydroxide                 | 6.1               | 8                    | I              | 279<br>408<br>409  | 0  | E5                  | P001   | -            | -             | -             |   |

| UN No. | Portable tanks and bulk containers |               | EmS                    | Stowage and handling          | Segregation           | Properties and observations   | UN No. |
|--------|------------------------------------|---------------|------------------------|-------------------------------|-----------------------|---|--------|
|        | Tank instructions                  | Provisions    |                        |                               |                       |   |        |
| (12)   | (13)<br>4.2.5<br>4.3               | (14)<br>4.2.5 | (15)<br>5.4.3.4<br>7.8 | (16a)<br>7.1<br>7.3-7.7       | (16b)<br>7.2-7.7      | (17)  | (18)   |
| 3552   | -                                  | -             | F-A, S-I               | Category A<br>SW19            | -                     | Electrical batteries containing sodium ion may react (e.g. flame, heat, emission of toxic, corrosive or flammable gases or vapours) or disassemble due to damage, defects or short circuit.   | 3552   |
| 3553   | -                                  | -             | F-D, S-U               | Category D<br>SW2             | SG43<br>SG46          | Gas that is extremely flammable and spontaneously ignites in air (pyrophoric). Repulsive odour. Slowly decomposes with water. Irritant to mucous membranes and is an asphyxiant. Boiling point -14.3°C. Lighter than air (0.675).   | 3553   |
| 3554   | -                                  | -             | F-A, S-B               | Category B<br>SW1             | -                     | Gallium (UN 2803) is highly corrosive to aluminium. Carriage should be prohibited in hovercraft and other ships constructed from aluminium.   | 3554   |
| 3555   | -                                  | -             | F-E, S-Y               | Category D<br>SW1<br>H2<br>H3 | SG30                  | Desensitized explosive. Explosive and sensitive to friction in the dry state. May form extremely sensitive compounds with heavy metals and their salts.   | 3555   |
| 3556   | -                                  | -             | F-A, S-I               | Category A                    | -                     | This entry applies to vehicles powered by lithium ion batteries with the batteries installed, such as electrically-powered cars, lawn tractors, wheelchairs and other mobility aids.  | 3556   |
| 3557   | -                                  | -             | F-A, S-I               | Category A                    | -                     | This entry applies to vehicles powered by lithium metal batteries with the batteries installed, such as electrically-powered cars, lawn tractors, wheelchairs and other mobility aids.  | 3557   |
| 3558   | -                                  | -             | F-A, S-I               | Category A                    | -                     | This entry applies to vehicles powered by sodium ion batteries with the batteries installed, such as electrically-powered cars, lawn tractors, wheelchairs and other mobility aids.   | 3558   |
| 3559   | -                                  | -             | F-B, S-X               | Category A                    | -                     | Articles which contain a pyrotechnic substance, which are intended to disperse a fire extinguishing agent (or aerosol) when activated, and which do not contain any other dangerous goods.  | 3559   |
| 3560   | T14                                | TP2           | F-A, S-B               | Category D<br>SW2             | SGG2<br>SGG18<br>SG35 | Colourless liquid with a strong ammonia-like odour that is miscible with water. Highly toxic if swallowed, by skin contact or by inhalation. Corrosive to metal. When heated emits toxic fumes of nitrogen oxides and ammonia. Causes burns to skin, eyes, and mucous membranes. Reacts violently with acids. | 3560   |



## Chapter 3.3

### *Special provisions applicable to certain substances, materials or articles*

- 3.3.1 When column 6 of the Dangerous Goods List indicates that a special provision is relevant to a dangerous good, the meaning and requirement(s) of that special provision are as set out below. Where a special provision includes a requirement for package marking, the provisions of 5.2.1.2.1 to .4 shall be met. If the required mark is in the form of specific wording indicated in quotation marks, such as "LITHIUM BATTERIES FOR DISPOSAL", the size of the mark shall be at least 12 mm, unless otherwise indicated in the special provision or elsewhere in this Code.
- 16 Samples of new or existing explosive substances or articles may be transported as directed by the competent authority for purposes including: testing, classification, research and development, quality control, or as a commercial sample. Explosive samples which are not wetted or desensitized shall be limited to 10 kg in small packages as specified by the competent authority. Explosive samples which are wetted or desensitized shall be limited to 25 kg.
- 23 Even though this substance has a flammability hazard, it only exhibits such hazard under extreme fire conditions in confined areas.
- 26 This substance is not permitted for transport in portable tanks, or intermediate bulk containers with a capacity exceeding 450 L, due to the potential initiation of an explosion when transported in large volumes.
- △ 28 This substance may be transported under the provisions of class 3 or class 4.1 only if it is so packaged that the percentage of diluent will not fall below that stated, at any time during transport (see 2.3.1.4 and 2.4.2.4). In cases where the diluent is not stated, the substance shall be packed so that the amount of explosive substance does not exceed the stated value.
- 29 The packages, including bales, are exempt from labelling provided that they are marked with the appropriate class (e.g. "class 4.2").
- 32 When in any other form, this substance is not subject to the provisions of this Code.
- 37 When coated, this substance is not subject to the provisions of this Code.
- 38 This substance, when it contains not more than 0.1% calcium carbide, is not subject to the provisions of this Code.
- 39 This substance, when it contains less than 30% or not less than 90% silicon, is not subject to the provisions of this Code.
- 43 When offered for transport as pesticides, these substances shall be transported under the relevant pesticide entry and in accordance with the relevant pesticide provisions (see 2.6.2.3 and 2.6.2.4).
- 45 Antimony sulphides and oxides which contain not more than 0.5% of arsenic, calculated on the total mass, are not subject to the provisions of this Code.
- 47 Ferricyanides and ferrocyanides are not subject to the provisions of this Code.
- 59 These substances, when they contain not more than 50% magnesium, are not subject to the provisions of this Code.
- 61 The technical name, which shall supplement the proper shipping name, shall be the ISO common name, or other name listed in *The WHO Recommended Classification of Pesticides by Hazard and Guidelines to Classification* or the name of the active substance (see also 3.1.2.8.1.1).
- 62 This substance, when it contains not more than 4% sodium hydroxide, is not subject to the provisions of this Code.
- 63 The division of class 2 and the subsidiary hazards depend on the nature of the contents of the aerosol dispenser. The following provisions shall apply:
- .1 Class 2.1 applies if the contents include 85% by mass or more flammable components and the chemical heat of combustion is 30 kJ/g or more;
  - .2 Class 2.2 applies if the contents contain 1% by mass or less flammable components and the heat of combustion is less than 20 kJ/g.



## Part 3 – Dangerous Goods List, special provisions and exceptions

3

- .3 Otherwise the product shall be classified as tested by the tests described in the *Manual of Tests and Criteria*, part III, section 31. Extremely flammable and flammable aerosols shall be classified in class 2.1; non-flammable in class 2.2;
- .4 Gases of class 2.3 shall not be used as a propellant in an aerosol dispenser;
- .5 Where the contents other than the propellant of aerosol dispensers to be ejected are classified as class 6.1 packing groups II or III or class 8 packing groups II or III, the aerosol shall have a subsidiary hazard of class 6.1 or class 8;
- .6 Aerosols with contents meeting the criteria for packing group I for toxicity or corrosivity shall be prohibited from transport;
- .7 Except for consignments transported in limited quantities (see chapter 3.4), packages containing aerosols shall bear labels for the primary hazard and for the subsidiary hazard(s), if any.

Flammable components are flammable liquids, flammable solids or flammable gases and gas mixtures as defined in notes 1 to 3 of subsection 31.1.3 of part III of the *Manual of Tests and Criteria*. This designation does not cover pyrophoric, self-heating or water-reactive substances. The chemical heat of combustion shall be determined by one of the following methods: ASTM D240, ISO/FDIS 13943:1999 (E/F) 86.1 to 86.3 or NFPA 30B.

- 65 Hydrogen peroxide aqueous solutions with less than 8% hydrogen peroxide are not subject to the provisions of this Code.
- 66 Cinnabar is not subject to the provisions of this Code.
- 105 Nitrocellulose meeting the descriptions of UN 2556 or UN 2557 may be classified in class 4.1.
- 113 The transport of chemically unstable mixtures is prohibited.
- 117 Only regulated when transported by sea.
- 119 Refrigerating machines and refrigerating-machinery components including machines or other appliances which have been designed for the specific purpose of keeping food or other items at a low temperature in an internal compartment, and air-conditioning units. Refrigerating machines and refrigerating-machine components are not subject to the provisions of this Code if they contain less than 12 kg of gas in class 2.2 or less than 12 L of ammonia solution (UN 2672).
- 122 The subsidiary hazard(s), the control and emergency temperatures, if any, and the generic entry number for each of the currently assigned organic peroxide formulations are given in 2.5.3.2.4, 4.1.4.2 packing instruction IBC520 and 4.2.5.2.6 portable tank instruction T23.
- 123 Only regulated when transported by air or by sea.
- 127 Other inert material or inert material mixture may be used at the discretion of the competent authority, provided this inert material has identical phlegmatizing properties.
- 131 The phlegmatized substance shall be significantly less sensitive than dry PETN.
- 133 If over-confined in packagings, this substance may exhibit explosive behaviour. Packagings authorized under packing instruction P409 are intended to prevent over-confinement. When a packaging other than those prescribed under packing instruction P409 is authorized by the competent authority of the country of origin in accordance with 4.1.3.7, the package shall bear an "EXPLOSIVE" subsidiary hazard label (Model No. 1, see 5.2.2.2.2) unless the competent authority of the country of origin has permitted this label to be dispensed with for the specific packaging employed because test data have proved that the substance in this packaging does not exhibit explosive behaviour (see 5.4.1.5.5.1). The provisions of 7.1.3.1, 7.1.4.4 and 7.2.3.3 shall also be considered.
- 135 The dihydrated sodium salt of dichloroisocyanuric acid does not meet the criteria for inclusion in class 5.1 and is not subject to the provisions of this Code unless meeting the criteria for inclusion in another class or division.
- 138 *p*-Bromobenzyl cyanide is not subject to the provisions of this Code.
- 141 Products which have undergone sufficient heat treatment so that they present no hazard during transport are not subject to the provisions of this Code.
- 142 Solvent-extracted soya bean meal containing not more than 1.5% oil and 11% moisture, being substantially free from flammable solvents, which is accompanied by a certificate from the shipper stating that the substance, as offered for shipment, meets this requirement is not subject to the provisions of this Code.
- 144 An aqueous solution containing not more than 24% alcohol by volume is not subject to the provisions of this Code.
- 145 Alcoholic beverages of packing group III, when transported in receptacles of 250 L or less, are not subject to the provisions of this Code.
- 152 The classification of this substance will vary with particle size and packaging, but borderlines have not been experimentally determined. Appropriate classifications shall be made as required by 2.1.3.

## Chapter 3.3 – Special provisions applicable to certain substances, materials or articles

3

- 153 This entry applies only if it is demonstrated, on the basis of tests, that the substance, when in contact with water, is not combustible nor shows a tendency to auto-ignition and that the mixture of gases evolved is not flammable.
- 163 A substance specifically listed by name in the Dangerous Goods List shall not be transported under this entry. Materials transported under this entry may contain 20% or less nitrocellulose provided the nitrocellulose contains not more than 12.6% nitrogen (by dry mass).
- 168 Asbestos which is immersed or fixed in a natural or artificial binder (such as cement, plastics, asphalt, resins or mineral ore) in such a way that no escape of hazardous quantities of respirable asbestos fibres can occur during transport is not subject to the provisions of this Code. Manufactured articles containing asbestos and not meeting this provision are nevertheless not subject to the provisions of this Code when packaged so that no escape of hazardous quantities of respirable asbestos fibres can occur during transport.
- 169 Phthalic anhydride in the solid state and tetrahydrophthalic anhydride, with not more than 0.05% maleic anhydride, are not subject to the provisions of this Code. Phthalic anhydride molten at a temperature above its flashpoint, with not more than 0.05% maleic anhydride, shall be classified under UN 3256.
- 172 Where a radioactive material has (a) subsidiary hazard(s):
- .1 The substance shall be allocated to packing group I, II or III, if appropriate, by application of the packing group criteria provided in part 2 corresponding to the nature of the predominant subsidiary hazard;
  - .2 Packages shall be labelled with subsidiary hazard labels corresponding to each subsidiary hazard exhibited by the material; corresponding placards shall be affixed to cargo transport units in accordance with the relevant provisions of 5.3.1;
  - .3 For the purposes of documentation and package marking, the proper shipping name shall be supplemented with the name of the constituents which most predominantly contribute to this (these) subsidiary hazard(s) and which shall be enclosed in parenthesis;
  - .4 The dangerous goods transport document shall indicate the class or division of the subsidiary hazard and, where assigned, the packing group as required by 5.4.1.4.1.4 and 5.4.1.4.1.5.
- For packing, see also 4.1.9.1.5.
- 177 Barium sulphate is not subject to the provisions of this Code.
- 178 This entry shall be used only when no other appropriate entry exists in the list, and only with the approval of the competent authority of the country of origin.
- 181 Packages containing this type of substance shall bear the “EXPLOSIVE” subsidiary hazard label (Model No. 1, see 5.2.2.2.2) unless the competent authority of the country of origin has permitted this label to be dispensed with for the specific packaging employed because test data have proved that the substance in this packaging does not exhibit explosive behaviour (see 5.4.1.5.5.1). The provisions of 7.2.3.3 shall also be considered.
- 182 The group of alkali metals includes lithium, sodium, potassium, rubidium and caesium.
- 183 The group of alkaline earth metals includes magnesium, calcium, strontium and barium.
- 188 Cells and batteries offered for transport are not subject to other provisions of this Code if they meet the following:
- △ .1 For a lithium metal or lithium alloy cell, the lithium content is not more than 1 g, and for a lithium-ion or sodium-ion cell, the watt-hour rating is not more than 20 Wh;
  - △ .2 For a lithium metal or lithium alloy battery, the aggregate lithium content is not more than 2 g, and for a lithium-ion or sodium-ion battery, the watt-hour rating is not more than 100 Wh. Lithium-ion and sodium-ion batteries subject to this provision shall be marked with the watt-hour rating on the outside case, except lithium-ion batteries manufactured before 1 January 2009;
  - △ .3 Each lithium cell or battery meets the provisions of 2.9.4.1, 2.9.4.5, 2.9.4.6 if applicable and 2.9.4.7 or for sodium-ion cells or batteries, the provisions of 2.9.5.1, 2.9.5.5 and 2.9.5.6 shall apply;
  - .4 Cells and batteries, except when installed in equipment, shall be packed in inner packagings that completely enclose the cell or battery. Cells and batteries shall be protected so as to prevent short circuits. This includes protection against contact with electrically conductive material within the same packaging that could lead to a short circuit. The inner packagings shall be packed in strong outer packagings which conform to the provisions of 4.1.1.1, 4.1.1.2, and 4.1.1.5;

## Part 3 – Dangerous Goods List, special provisions and exceptions

3

- .5 Cells and batteries when installed in equipment shall be protected from damage and short circuit, and the equipment shall be equipped with an effective means of preventing accidental activation. This requirement does not apply to devices which are intentionally active in transport (radio frequency identification (RFID) transmitters, watches, sensors, etc.) and which are not capable of generating a dangerous evolution of heat. When batteries are installed in equipment, the equipment shall be packed in strong outer packagings constructed of suitable material of adequate strength and design in relation to the packaging's capacity and its intended use unless the battery is afforded equivalent protection by the equipment in which it is contained;
- △ .6 Each package shall be marked with the appropriate lithium or sodium ion battery mark, as illustrated in 5.2.1.10;
- Note:** Packages containing lithium batteries packed in conformity with the provisions of part 4, chapter 11, packing instructions 965 or 968, Section IB of the ICAO Technical Instructions for the Safe Transport of Dangerous Goods by Air that bear the mark as shown in 5.2.1.10 (lithium battery mark) and the label shown in 5.2.2.2.2, Model No. 9A shall be deemed to meet the provisions of this special provision.
- This requirement does not apply to:
- .1 packages containing only button cell batteries installed in equipment (including circuit boards); and
- .2 packages containing no more than four cells or two batteries installed in equipment, where there are not more than two packages in the consignment.
- △ When packages are placed in an overpack, the lithium or sodium battery mark shall either be clearly visible or be reproduced on the outside of the overpack and the overpack shall be marked with the word "OVERPACK". The lettering of the "OVERPACK" mark shall be at least 12 mm high;
- .7 Except when cells or batteries are installed in equipment, each package shall be capable of withstanding a 1.2 m drop test in any orientation without damage to cells or batteries contained therein, without shifting of the contents so as to allow battery to battery (or cell to cell) contact and without release of contents; and
- △ .8 Except when cells or batteries are installed in or packed with equipment, packages shall not exceed 30 kg gross mass. As used in this special provision "equipment" means apparatus for which the cells or batteries will provide electrical power for its operation.

As used above and elsewhere in this Code, "lithium content" means the mass of lithium in the anode of a lithium metal or lithium alloy cell.

Separate entries exist for lithium metal batteries and lithium ion batteries to facilitate the transport of these batteries for specific modes of transport and to enable the application of different emergency response actions.

A single cell battery as defined in part III, subsection 38.3.2.3 of the *Manual of Tests and Criteria* is considered a "cell" and shall be transported according to the requirements for "cells" for the purpose of this special provision.

- 190 Aerosol dispensers shall be provided with protection against inadvertent discharge. Aerosols with a capacity not exceeding 50 mL containing only non-toxic constituents are not subject to the provisions of this Code.
- 191 Receptacles with a capacity not exceeding 50 mL containing only non-toxic constituents are not subject to the provisions of this Code.
- 193 This entry may only be used for ammonium nitrate based compound fertilizers. They shall be classified in accordance with the procedure as set out in the *Manual of Tests and Criteria*, part III, section 39.
- 194 The control and emergency temperatures, if any, and the generic entry number for each of the currently assigned self-reactive substances are given in 2.4.2.3.2.3.
- 195 For certain organic peroxides types B or C, a smaller packaging than that allowed by packing methods OP5 or OP6 respectively has to be used (see 4.1.7 and 2.5.3.2.4).
- 196 Formulations which, in laboratory testing, neither detonate in the cavitated state nor deflagrate, which show no effect when heated under confinement and which exhibit no explosive power may be transported under this entry. The formulation must also be thermally stable (i.e. the SADT is 60°C or higher for a 50 kg package). Formulations not meeting these criteria shall be transported under the provisions of class 5.2 (see 2.5.3.2.4).
- 198 Nitrocellulose solutions containing not more than 20% nitrocellulose may be transported as paint, perfumery products or printing ink, as applicable. See UN Nos. 1210, 1263, 1266, 3066, 3469 and 3470.

## Chapter 3.3 – Special provisions applicable to certain substances, materials or articles

3

- 199 Lead compounds which, when mixed in a ratio of 1:1000 with 0.07M hydrochloric acid and stirred for one hour at a temperature of 23°C ± 2°C, exhibit a solubility of 5% or less (see ISO 3711:1990, *Lead chromate pigments and lead chromate-molybdate pigments – Specifications and methods of test*) are considered insoluble and are not subject to the provisions of this Code unless they meet the criteria for inclusion in another hazard class.
- 201 Lighters and lighter refills shall comply with the provisions of the country in which they were filled. They shall be provided with protection against inadvertent discharge. The liquid portion of the gas shall not exceed 85% of the capacity of the receptacle at 15°C. The receptacles, including the closures, shall be capable of withstanding an internal pressure of twice the pressure of the liquefied petroleum gas at 55°C. The valve mechanisms and ignition devices shall be securely sealed, taped or otherwise fastened or designed to prevent operation or leakage of the contents during transport. Lighters shall not contain more than 10 g of liquefied petroleum gas. Lighter refills shall not contain more than 65 g of liquefied petroleum gas.
- 203 This entry shall not be used for polychlorinated biphenyls, UN 2315.
- 204 Articles containing smoke-producing substance(s) corrosive according to the criteria for class 8 shall be labelled with a “CORROSIVE” subsidiary hazard label (Model No. 8, see 5.2.2.2.2).
- △ Articles containing smoke-producing substance(s) toxic by inhalation according to the criteria for class 6.1 shall be labelled with a “TOXIC” subsidiary hazard label (Model No. 6.1, see 5.2.2.2.2).
- 205 This entry shall not be used for PENTACHLOROPHENOL, UN 3155.
- 207 Plastics moulding compounds may be made from polystyrene, poly(methyl methacrylate) or other polymeric material.
- 208 The commercial grade of calcium nitrate fertilizer, when consisting mainly of a double salt (calcium nitrate and ammonium nitrate) containing not more than 10% ammonium nitrate and at least 12% water of crystallization, is not subject to the provisions of this Code.
- 209 The gas shall be at a pressure corresponding to ambient atmospheric pressure at the time the containment system is closed and this shall not exceed 105 kPa absolute.
- 210 Toxins from plant, animal or bacterial sources which contain infectious substances, or toxins that are contained in infectious substances, shall be classified under class 6.2.
- 215 This entry only applies to the technically pure substance or to formulations derived from it, having an SADT higher than 75°C, and, therefore, does not apply to formulations which are self-reactive substances (for self-reactive substances, see 2.4.2.3.2.3). Homogeneous mixtures containing not more than 35% by mass of azodicarbonamide and at least 65% of inert substance are not subject to this Code unless criteria of other classes are met.
- 216 Mixtures of solids which are not subject to the provisions of this Code and flammable liquids may be transported under this entry without first applying the classification criteria of class 4.1, provided there is no free liquid visible at the time the substance is loaded or at the time the packaging or cargo transport unit is closed. Each cargo transport unit shall be leakproof when used as a bulk container. Sealed packets and articles containing less than 10 mL of a packing group II or III flammable liquid absorbed into a solid material are not subject to the provisions of this Code provided there is no free liquid in the packet or article.
- 217 This entry shall only be used for mixtures of solids which are not subject to the provisions of this Code and toxic liquids may be transported under this entry without first applying the classification criteria of class 6.1, provided there is no free liquid visible at the time the substance is loaded or at the time the packaging or cargo transport unit is closed. Each cargo transport unit shall be leakproof when used as a bulk container. This entry shall not be used for solids containing a packing group I liquid.
- 218 This entry shall only be used for mixtures of solids which are not subject to the provisions of this Code and corrosive liquids may be transported under this entry without first applying the classification criteria of class 8, provided there is no free liquid visible at the time the substance is loaded or at the time the packaging or cargo transport unit is closed. Each cargo transport unit shall be leakproof when used as a bulk container. This entry shall not be used for solids containing a packing group I liquid.
- 219 Genetically modified microorganisms (GMMOs) and genetically modified organisms (GMOs) packed and marked in accordance with packing instruction P904 are not subject to any other provisions of this Code.
- If GMMOs or GMOs meet the definition in chapter 2.6 of a toxic substance or an infectious substance and the criteria for inclusion in class 6.1 or 6.2, the provisions of this Code for transporting toxic substances or infectious substances apply.
- 220 The technical name of the flammable liquid component only of this solution or mixture shall be shown in parentheses immediately following the proper shipping name.

## Part 3 – Dangerous Goods List, special provisions and exceptions

- 221 Substances included under this entry shall not be of packing group I.
- 223 If the chemical or physical properties of a substance covered by this description are such that, when tested, it does not meet the established defining criteria for the class or division listed in column 3, or any other class or division, it is not subject to the provisions of this Code except in the case of a marine pollutant where 2.10.3 applies.
- 224 Unless it can be demonstrated by testing that the sensitivity of the substance in its frozen state is no greater than in its liquid state, the substance shall remain liquid during normal transport conditions. It shall not freeze at temperatures above  $-15^{\circ}\text{C}$ .
- 225 Fire extinguishers under this entry may include installed actuating cartridges (cartridges, power device of division 1.4C or 1.4S) without changing the classification of class 2.2 provided the total quantity of deflagrating (propellant) explosives does not exceed 3.2 g per extinguishing unit. Fire extinguishers shall be manufactured, tested, approved and labelled according to the provisions applied in the country of manufacture.

**Note:** "Provisions applied in the country of manufacture" means the provisions applicable in the country of manufacture or those applicable in the country of use.

Fire extinguishers under this entry include:

- .1 portable fire extinguishers for manual handling and operation;  
**Note:** This entry applies to portable fire extinguishers, even if some components that are necessary for their proper functioning (e.g. hoses and nozzles) are temporarily detached, as long as the safety of the pressurized extinguishing agent containers is not compromised and the fire extinguishers continue to be identified as portable fire extinguishers.
- .2 fire extinguishers for installation in aircraft;
- .3 fire extinguishers mounted on wheels for manual handling;
- .4 fire extinguishing equipment or machinery mounted on wheels or wheeled platforms or units transported similar to (small) trailers; and
- .5 fire extinguishers composed of a non-rollable pressure drum and equipment, and handled, e.g. by fork lift or crane when loaded or unloaded.

**Note:** Pressure receptacles which contain gases for use in the above-mentioned extinguishers or for use in stationary fire-fighting installations shall meet the requirements in chapter 6.2 and all requirements applicable to the relevant dangerous goods when these pressure receptacles are transported separately.

- 226 Formulations of these substances containing not less than 30% non-volatile, non-flammable phlegmatizer are not subject to the provisions of this Code.
- 227 When phlegmatized with water and inorganic inert material, the content of urea nitrate may not exceed 75% by mass and the mixture shall not be capable of being detonated by the series 1, type (a) test in the *Manual of Tests and Criteria*, part I.
- 228 Mixtures not meeting the criteria for flammable gases (class 2.1) shall be transported under UN 3163.
- △ 230 Lithium cells and batteries may be transported under this entry if they meet the provisions of 2.9.4. Sodium-ion cells and batteries may be transported under this entry if they meet the provisions of 2.9.5.
- 232 This entry shall only be used when the substance does not meet the criteria of any other class. Transport in cargo transport units other than in tanks shall be in accordance with standards specified by the competent authority of the country of origin.
- 235 This entry applies to articles which contain class 1 explosive substances and which may also contain dangerous goods of other classes. These articles are used to enhance safety in vehicles, vessels or aircraft, e.g. air bag inflators, air bag modules, seat-belt pretensioners, and pyromechanical devices.
- 236 Polyester resin kits consist of two components: a base material (either class 3 or class 4.1, packing group II or III) and an activator (organic peroxide). The organic peroxide shall be type D, E, or F, not requiring temperature control. The packing group shall be II or III, according to the criteria of either class 3 or class 4.1, as appropriate, applied to the base material. The quantity limit shown in column 7a of the Dangerous Goods List of chapter 3.2 applies to the base material.
- 237 The membrane filters, including paper separators, coating or backing materials, etc., that are present in transport, shall not be liable to propagate a detonation as tested by one of the tests described in the *Manual of Tests and Criteria*, part I, test series 1(a).

In addition, the competent authority may determine, on the basis of the results of suitable burning rate tests taking account of the standard tests in the *Manual of Tests and Criteria*, part III, 33.2, that nitrocellulose membrane filters in the form in which they are to be transported are not subject to the provisions of this Code applicable to flammable solids in class 4.1.



## Chapter 3.3 – Special provisions applicable to certain substances, materials or articles

3

- 238 .1 Batteries can be considered as non-spillable provided that they are capable of withstanding the vibration and pressure differential tests given below, without leakage of battery fluid:
- Vibration test:** The battery is rigidly clamped to the platform of a vibration machine and a simple harmonic motion having an amplitude of 0.8 mm (1.6 mm maximum total excursion) is applied. The frequency is varied at the rate of 1 Hz/min between the limits of 10 Hz and 55 Hz. The entire range of frequencies and return is traversed in  $95 \pm 5$  minutes for each mounting position (direction of vibration) of the battery. The battery is tested in three mutually perpendicular positions (to include testing with fill openings and vents, if any, in an inverted position) for equal time periods.
- Pressure differential test:** Following the vibration test, the battery is stored for six hours at  $24^{\circ}\text{C} \pm 4^{\circ}\text{C}$  while subjected to a pressure differential of at least 88 kPa. The battery is tested in three mutually perpendicular positions (to include testing with fill openings and vents, if any, in an inverted position) for at least six hours in each position.
- Non-spillable type batteries which are an integral part of and necessary for the operation of mechanical or electronic equipment shall be securely fastened in the battery holder on the equipment and protected in such a manner as to prevent damage and short circuits.
- 238 .2 Non-spillable batteries are not subject to the provisions of this Code if, at a temperature of  $55^{\circ}\text{C}$ , the electrolyte will not flow from a ruptured or cracked case and there is no free liquid to flow and if, when packaged for transport, the terminals are protected from short circuit.
- 239 Batteries or cells shall not contain dangerous goods other than sodium, sulphur or sodium compounds (e.g. sodium polysulphides and sodium tetrachloroaluminate). Batteries or cells shall not be offered for transport at a temperature such that liquid elemental sodium is present in the battery or cell, unless approved and under the conditions established by the competent authority.
- Cells shall consist of hermetically sealed metal casings which fully enclose the dangerous goods and which are so constructed and closed as to prevent the release of the dangerous goods under normal conditions of transport.
- Batteries shall consist of cells secured within and fully enclosed by a metal casing so constructed and closed as to prevent the release of the dangerous goods under normal conditions of transport.
- 240 *Deleted.*
- 241 The formulation shall be prepared so that it remains homogeneous and does not separate during transport. Formulations with low nitrocellulose contents and not showing dangerous properties when tested for their liability to detonate, deflagrate or explode when heated under defined confinement by tests of test series 1(a), 2(b) and 2(c) respectively in the *Manual of Tests and Criteria*, part I and not being a flammable solid when tested in accordance with test N.1 in the *Manual of Tests and Criteria*, part III, subsection 33.2.4 (chips, if necessary, crushed and sieved to a particle size of less than 1.25 mm) are not subject to the provisions of this Code.
- 242 Sulphur is not subject to the provisions of this Code when it has been formed to a specific shape (such as prills, granules, pellets, pastilles or flakes).
- 243 Gasoline, motor spirit and petrol for use in spark-ignition engines (e.g. in automobiles, stationary engines and other engines) shall be assigned to this entry regardless of variations in volatility.
- 244 This entry includes materials and substances such as aluminium dross, aluminium skimmings, spent cathodes, spent potliner and aluminium salt slags.
- Before loading, these by-products shall be cooled to ambient temperature, unless they have been calcined to remove moisture. Cargo transport units containing bulk loads shall be adequately ventilated and protected against ingress of water throughout the journey.
- 247 Alcoholic beverages containing more than 24% alcohol but not more than 70% by volume, when transported as part of the manufacturing process, may be transported in wooden barrels with a capacity of more than 250 L and not more than 500 L meeting the general requirements of 4.1.1, as appropriate, on the following conditions:
- .1 the wooden barrels shall be checked and tightened before filling;
  - .2 sufficient ullage (not less than 3%) shall be left to allow for the expansion of the liquid;
  - .3 the wooden barrels shall be transported with the bungholes pointing upwards;
  - .4 the wooden barrels shall be transported in containers meeting the provisions of the *International Convention for Safe Containers, 1972 (CSC Convention)*, as amended, and each wooden barrel shall be secured in custom-made cradles and be wedged by appropriate means to prevent it from being displaced in any way during transport; and
  - .5 when carried on board ships, the containers shall be stowed in open cargo spaces or in enclosed cargo spaces complying with the requirements for class 3 flammable liquids with a flashpoint of  $23^{\circ}\text{C}$  c.c. or less in regulation II-2/19 of SOLAS, 74, as amended or regulation II-2/54 of SOLAS 74, as amended by the resolutions indicated in II-2/1.2.1, as applicable.



## Part 3 – Dangerous Goods List, special provisions and exceptions

3

- 249 Ferrocium, stabilized against corrosion, with a minimum iron content of 10% is not subject to the provisions of this Code.
- 250 This entry may only be used for samples of chemicals taken for analysis in connection with the implementation of the Convention on the Prohibition of the Development, Production, Stockpiling and Use of Chemical Weapons and on their Destruction. The transport of substances under this entry shall be in accordance with the chain of custody and security procedures specified by the Organization for the Prohibition of Chemical Weapons.
- The chemical sample may only be transported provided prior approval has been granted by the competent authority or the Director General of the Organization for the Prohibition of Chemical Weapons and providing the sample complies with the following conditions:
- .1 it shall be packaged according to packing instruction 623 in the International Civil Aviation Organization's Technical Instructions for the Safe Transport of Dangerous Goods by Air; and
  - .2 during transport, it shall be accompanied by a copy of the document of approval for transport, showing the quantity limitations and the packing provisions.
- 251 The entry CHEMICAL KIT or FIRST AID KIT is intended to apply to boxes, cases, etc., containing small quantities of various dangerous goods which are used, for example, for medical, analytical, testing or repair purposes. Such kits shall only contain dangerous goods that are permitted as:
- .1 excepted quantities not exceeding the quantity indicated by the code in column 7b of the Dangerous Goods List of chapter 3.2, provided that the net quantity per inner packaging and net quantity per package are as prescribed in 3.5.1.2 and 3.5.1.3; or
  - .2 limited quantities as indicated in column 7a of the Dangerous Goods List of chapter 3.2, provided that the net quantity per inner packaging does not exceed 250 mL or 250 g.
- Components shall not react dangerously (see 4.1.1.6). The total quantity of dangerous goods in any one kit shall not exceed either 1 L or 1 kg.
- For the purposes of completion of the dangerous goods transport document as set out in 5.4.1.4.1, the packing group shown on the document shall be the most stringent packing group assigned to any individual substance in the kit. Where the kit contains only dangerous goods to which no packing group is assigned, no packing group need be indicated on the dangerous goods transport document.
- Kits which are carried on board vehicles for first-aid or operating purposes are not subject to the provisions of this Code.
- Chemical kits and first aid kits containing dangerous goods in inner packagings which do not exceed the quantity limits for limited quantities applicable to individual substances as specified in column 7a of the Dangerous Goods List may be transported in accordance with chapter 3.4.
- △ 252 .1 Ammonium nitrate hot concentrated solutions can be transported under this entry provided:
- .1 The solution contains not more than 93% ammonium nitrate.
  - .2 The solution contains at least 7% water.
  - .3 The solution contains not more than 0.2% combustible material.
  - .4 The solution contains no chlorine compounds in quantities such that the chloride ion level exceeds 0.02%.
  - .5 The pH of an aqueous solution of 10% of the substance is between 5 and 7, measured at 25°C.
  - .6 The maximum allowable transport temperature of the solution is 140°C.
- .2 Additionally, ammonium nitrate hot concentrate solutions are not subject to this Code provided:
- .1 The solution contains not more than 80% ammonium nitrate.
  - .2 The solution contains not more than 0.2% combustible material.
  - .3 The ammonium nitrate remains in solution under all conditions of transport.
  - .4 The solution does not meet the criteria of any other class or division.
- 266 This substance, when containing less alcohol, water or phlegmatizer than specified, shall not be transported, unless specifically authorized by the competent authority.
- 267 Any explosives, blasting, type C containing chlorates shall be segregated from explosives containing ammonium nitrate or other ammonium salts.
- 270 Aqueous solutions of class 5.1 inorganic solid nitrate substances are considered as not meeting the criteria of class 5.1 if the concentration of the substances in solution at the minimum temperature encountered in transport is not greater than 80% of the saturation limit.

## Chapter 3.3 – Special provisions applicable to certain substances, materials or articles

3

- 271 Lactose or glucose or similar materials may be used as a phlegmatizer provided that the substance contains not less than 90%, by mass, of phlegmatizer. The competent authority may authorize these mixtures to be classified under class 4.1 on the basis of series 6(c) tests of part I of the *Manual of Tests and Criteria* on at least three packages as prepared for transport. Mixtures containing at least 98%, by mass, of phlegmatizer are not subject to the provisions of this Code. Packages containing mixtures with not less than 90%, by mass, of phlegmatizer need not bear a “TOXIC” subsidiary hazard label.
- 272 This substance shall not be transported under the provisions of class 4.1 unless specifically authorized by the competent authority (see UN 0143 or UN 0150 as appropriate).
- 273 Maneb and maneb preparations stabilized against self-heating need not be classified in class 4.2 when it can be demonstrated by testing that a cubic volume of 1 m<sup>3</sup> of substance does not self-ignite and that the temperature at the centre of the sample does not exceed 200°C when the sample is maintained at a temperature of not less than 75°C ± 2°C for a period of 24 hours.
- 274 For the purposes of documentation and package marking, the proper shipping name shall be supplemented with the technical name (see 3.1.2.8.1).
- For UN 3077 and UN 3082 only, the technical name may be a name shown in capital letters in column 2 of the Dangerous Goods List, provided that this name does not include “N.O.S.” and that special provision 274 is not assigned. The name which most appropriately describes the substance or mixture shall be used, e.g.:
- UN 3082, ENVIRONMENTALLY HAZARDOUS SUBSTANCE, LIQUID, N.O.S. (PAINT)
- UN 3082, ENVIRONMENTALLY HAZARDOUS SUBSTANCE, LIQUID, N.O.S. (PERFUMERY PRODUCTS).
- 277 For aerosols or receptacles containing toxic substances, the limited quantity value is 120 mL. For all other aerosols or receptacles, the limited quantity value is 1,000 mL.
- 278 These substances shall not be classified and transported unless authorized by the competent authority on the basis of results from series 2 tests and series 6(c) tests of part I of the *Manual of Tests and Criteria* on packages as prepared for transport (see 2.1.3.1). The competent authority shall assign the packing group on the basis of the chapter 2.3 criteria and the package type used for the series 6(c) tests.
- 279 The substance is assigned to this classification or packing group based on human experience rather than the strict application of classification criteria set out in this Code.
- △ 280 This entry applies to safety devices for vehicles, vessels or aircraft, e.g. air bag inflators, air bag modules, seat-belt pretensioners, and pyromechanical devices, which contain dangerous goods of class 1 or of other classes, when transported as component parts and if these articles as presented for transport have been tested in accordance with test series 6(c) of part I of the *Manual of Tests and Criteria*, with no explosion of the device, no fragmentation of device casing or pressure receptacle, and no projection hazard nor thermal effect which would significantly hinder fire-fighting or emergency response efforts in the immediate vicinity. This entry does not apply to life-saving appliances described in special provision 296 (UN Nos. 2990 and 3072) or to fire suppressant dispersing devices described in special provision 407 (UN Nos. 0514 and 3559).
- 281 Transport of hay, straw or bhusa when wet, damp or contaminated with oil is prohibited and when not wet or contaminated with oil is subject to the provisions of this Code.
- 283 Articles, containing gas, intended to function as shock absorbers, including impact-energy-absorbing devices or pneumatic springs, are not subject to the provisions of this Code provided:
- .1 each article has a gas space capacity not exceeding 1.6 L and a charge pressure not exceeding 280 bar where the product of the capacity (litres) and charge pressure (bar) does not exceed 80 (i.e. 0.5 L gas space and 160 bar charge pressure, 1 L gas space and 80 bar charge pressure, 1.6 L gas space and 50 bar charge pressure, 0.28 L gas space and 280 bar charge pressure);
  - .2 each article has a minimum burst pressure of 4 times the charge pressure at 20°C for products not exceeding 0.5 L gas space capacity and 5 times charge pressure for products greater than 0.5 L gas space capacity;
  - .3 each article is manufactured from material which will not fragment upon rupture;
  - .4 each article is manufactured in accordance with a quality-assurance standard acceptable to the competent authority; and
  - .5 the design type has been subjected to a fire test demonstrating that pressure in the article is relieved by means of a fire-degradable seal or other pressure relief device, such that the article will not fragment and that the article does not rocket.

## Part 3 – Dangerous Goods List, special provisions and exceptions

- 3
- 284 An oxygen generator, chemical, containing oxidizing substances shall meet the following conditions:
- .1 the generator, when containing an explosive device, shall only be transported under this entry when excluded from class 1 in accordance with 2.1.3 of this Code;
  - .2 the generator, without its packaging, shall be capable of withstanding a 1.8 m drop test onto a rigid, non-resilient, flat and horizontal surface, in the position most likely to cause damage, without loss of its contents and without actuation; and
  - .3 when the generator is equipped with an actuating device, it shall have at least two positive means of preventing unintentional actuation.
- 286 Nitrocellulose membrane filters covered by this entry, each with a mass not exceeding 0.5 g, are not subject to the provisions of this Code when contained individually in an article or a sealed packet.
- 288 These substances shall not be classified and transported unless authorized by the competent authority on the basis of results from series 2 tests and a series 6(c) test of part I of the *Manual of Tests and Criteria* on packages as prepared for transport (see 2.1.3).
- 289 Safety devices, electrically initiated and safety devices, pyrotechnic installed in vehicles, vessels or aircraft or in completed components such as steering columns, door panels, seats, etc., are not subject to the provisions of this Code.
- 290 When this radioactive material meets the definitions and criteria of other classes or divisions as defined in part 2, it shall be classified in accordance with the following:
- .1 where the substance meets the criteria for dangerous goods in excepted quantities as set out in chapter 3.5, the packagings shall be in accordance with 3.5.2 and meet the testing requirements of 3.5.3. All other requirements applicable to radioactive material, excepted packages as set out in 1.5.1.5 shall apply without reference to the other class or division;
  - .2 where the quantity exceeds the limits specified in 3.5.1.2, the substance shall be classified in accordance with the predominant subsidiary hazard. The dangerous goods transport document shall describe the substance with the UN number and proper shipping name applicable to the other class supplemented with the name applicable to the radioactive excepted package according to column 2 in the Dangerous Goods List of chapter 3.2, and the substance shall be transported in accordance with the provisions applicable to that UN number. An example of the information shown on the dangerous goods transport document is:  
UN 1993, Flammable liquid, N.O.S. (ethanol and toluene mixture), Radioactive material, excepted package – limited quantity of material, class 3, PG II.  
In addition, the provisions of 2.7.2.4.1 shall apply;
  - .3 the provisions of chapter 3.4 for the transport of dangerous goods packed in limited quantities shall not apply to substances classified in accordance with subparagraph .2;
  - .4 when the substance meets a special provision that exempts this substance from all dangerous goods provisions of the other classes, it shall be classified in accordance with the applicable UN number of class 7 and all requirements specified in 1.5.1.5 shall apply.
- 291 Flammable liquefied gases shall be contained within refrigerating-machine components. These components shall be designed and tested to at least three times the working pressure of the machinery. The refrigerating machines and refrigerating-machine components shall be designed and constructed to contain the liquefied gas and preclude the risk of bursting or cracking of the pressure-retaining components during normal conditions of transport. Refrigerating machines and refrigerating-machine components are not subject to the provisions of this Code if they contain less than 12 kg of gas.
- 293 The following definitions apply to matches:
- .1 *Fusee matches* are matches the heads of which are prepared with a friction-sensitive igniter composition and a pyrotechnic composition which burns with little or no flame, but with intense heat;
  - .2 *Safety matches* are matches that combined with or attached to the box, book or card that can be ignited by friction only on a prepared surface;
  - .3 *“Strike anywhere” matches* are matches that can be ignited by friction on a solid surface;
  - .4 *Wax ‘Vesta’ matches* are matches that can be ignited by friction either on a prepared surface or on a solid surface.
- 294 Safety matches and wax ‘Vesta’ matches in an outer packaging not exceeding 25 kg net mass are not subject to any other provision (except marking) of this Code when packaged in accordance with packing instruction P407.
- 295 Batteries need not be individually marked and labelled if the pallet bears the appropriate mark and label.

## Chapter 3.3 – Special provisions applicable to certain substances, materials or articles

3

- 296 These entries apply to life-saving appliances such as liferafts, personal flotation devices and self-inflating slides. UN 2990 applies to self-inflating appliances. UN 3072 applies to life-saving appliances that are not self-inflating. Life-saving appliances may contain:
- .1 signal devices (class 1) which may include smoke and illumination signal flares packed in packagings that prevent them from being inadvertently activated;
  - .2 for UN 2990 only, cartridges, power device of division 1.4, compatibility group S, may be contained for purposes of the self-inflating mechanism and provided that the quantity of explosives per appliance does not exceed 3.2 g;
  - .3 class 2.2 compressed or liquefied gases;
  - △ .4 electric storage batteries (class 8) and lithium or sodium iron batteries (class 9);
  - .5 first aid kits or repair kits containing small quantities of dangerous goods (e.g. classes 3, 4.1, 5.2, 8 or 9 substances); or
  - .6 “Strike anywhere” matches packed in packagings that prevent them from being inadvertently activated.
- Life-saving appliances packed in strong rigid outer packagings with a total maximum gross mass of 40 kg, containing no dangerous goods other than class 2.2 compressed or liquefied gases with no subsidiary hazard in receptacles with a capacity not exceeding 120 mL, installed solely for the purpose of the activation of the appliance, are not subject to the provision of this Code.
- 299 Consignments of:
- .1 Cotton, dry having a density not less than 360 kg/m<sup>3</sup>;
  - .2 Flax, dry having a density not less than 400 kg/m<sup>3</sup>;
  - .3 Sisal, dry having a density not less than 360 kg/m<sup>3</sup>; and
  - .4 Tampico fibre, dry having a density not less than 360 kg/m<sup>3</sup>,
- according to ISO 8115:1986, are not subject to the provisions of this Code when transported in closed cargo transport units.
- 300 Fish meal, fish scrap and krill meal shall not be transported if the temperature at the time of loading exceeds 35°C or 5°C above the ambient temperature, whichever is higher.
- 301 This entry only applies to articles such as machinery, apparatus or devices containing dangerous goods as a residue or an integral element of the articles. It shall not be used for articles for which a proper shipping name already exists in the Dangerous Goods List. Articles transported under this entry shall only contain dangerous goods which are authorized to be transported in accordance with the provisions in chapter 3.4 (Limited quantities). The quantity of dangerous goods in articles shall not exceed the quantity specified in column 7a of the Dangerous Goods List for each item of dangerous goods contained. If the articles contains more than one item of dangerous goods, the individual dangerous goods shall be enclosed to prevent them reacting dangerously with one another during transport (see 4.1.1.6). When it is required to ensure liquid dangerous goods remain in their intended orientation, orientation arrows shall be displayed on at least two opposite vertical sides with the arrows pointing in the correct direction in accordance with 5.2.1.7.1.
- 302 Fumigated cargo transport units containing no other dangerous goods are only subject to the provisions of 5.5.2.
- 303 Receptacles shall be assigned to the class and, if any, subsidiary hazard of the gas or mixture of gases contained therein determined in accordance with the provisions of chapter 2.2.
- 304 This entry may only be used for the transport of non-activated batteries which contain dry potassium hydroxide and which are intended to be activated prior to use by the addition of an appropriate amount of water to the individual cells.
- 305 These substances are not subject to the provisions of this Code when in concentrations of not more than 50 mg/kg.
- 306 This entry may only be used for substances that are too insensitive for acceptance into class 1 when tested in accordance with test series 2 (see *Manual of Tests and Criteria*, part I).
- 307 This entry may only be used for ammonium nitrate based fertilizers. They shall be classified in accordance with the procedure as set out in the *Manual of Tests and Criteria*, part III, section 39.
- 308 Stabilization of fish meal shall be achieved to prevent spontaneous combustion by effective application of ethoxyquin, BHT (butylated hydroxytoluene) or tocopherols (also used in a blend with rosemary extract) at the time of production. The said application shall occur within twelve months prior to shipment. Fish scrap or fish meal shall contain at least 50 ppm (mg/kg) of ethoxyquin, 100 ppm (mg/kg) of BHT or 250 ppm (mg/kg) of tocopherol based antioxidant at the time of shipment.

## Part 3 – Dangerous Goods List, special provisions and exceptions

- 309 This entry applies to non-sensitized emulsions, suspensions and gels consisting primarily of a mixture of ammonium nitrate and fuel, intended to produce a Type E blasting explosive only after further processing prior to use.  
The mixture for emulsions typically has the following composition: 60–85% ammonium nitrate, 5–30% water, 2–8% fuel, 0.5–4% emulsifier agent, 0–10% soluble flame suppressants, and trace additives. Other inorganic nitrate salts may replace part of the ammonium nitrate.  
The mixture for suspensions and gels typically has the following composition: 60–85% ammonium nitrate, 0–5% sodium or potassium perchlorate, 0–17% hexamine nitrate or monomethylamine nitrate, 5–30% water, 2–15% fuel, 0.5–4% thickening agent, 0–10% soluble flame suppressants, and trace additives. Other inorganic nitrate salts may replace part of the ammonium nitrate.  
Substances shall satisfy the criteria for classification as an ammonium nitrate emulsion, suspension or gel, intermediate for blasting explosives (ANE) of Test Series 8 of the *Manual of Tests and Criteria*, part I, section 18 and be approved by the competent authority.
- △ 310 Cells or batteries from production runs of not more than 100 cells or batteries, or pre-production prototypes of cells or batteries when these prototypes are transported for testing, shall meet the provisions of 2.9.4 with the exception of 2.9.4.1, 2.9.4.5.7, 2.9.4.6.3 if applicable, 2.9.4.6.4 if applicable and 2.9.4.7.  
**Note:** “Transported for testing” includes, but is not limited to, testing described in the *Manual of Tests and Criteria*, part III, subsection 38.3, integration testing and product performance testing.  
These cells and batteries shall be packaged in accordance with packing instruction P910 of 4.1.4.1 or LP905 of 4.1.4.3, as applicable.  
Articles (UN Nos. 3537, 3538, 3540, 3541, 3546, 3547 or 3548) may contain such cells or batteries provided that the applicable parts of packing instruction P006 of 4.1.4.1 or LP03 of 4.1.4.3, as applicable, are met.  
The transport document shall include the following statement: “Transport in accordance with special provision 310”.  
Damaged or defective cells, batteries, or cells and batteries contained in equipment shall be transported in accordance with special provision 376.  
Cells, batteries or cells and batteries contained in equipment transported for disposal or recycling may be packaged in accordance with special provision 377 and packing instruction P909 of 4.1.4.1.
- 311 Substances shall not be transported under this entry unless approved by the competent authority on the basis of the results of appropriate tests according to part I of the *Manual of Tests and Criteria*. Packaging shall ensure that the percentage of diluent does not fall below that stated in the competent authority approval at any time during transport.
- 314 .1 These substances are liable to exothermic decomposition at elevated temperatures. Decomposition can be initiated by heat or by impurities (e.g. powdered metals (iron, manganese, cobalt, magnesium) and their compounds).  
.2 During the course of transport, these substances shall be shaded from direct sunlight and all sources of heat and be placed in adequately ventilated areas.
- 315 This entry shall not be used for class 6.1 substances which meet the inhalation toxicity criteria for packing group I described in 2.6.2.2.4.3.
- 316 This entry applies only to calcium hypochlorite, dry, when transported in non-friable tablet form.
- 317 “Fissile-excepted” applies only to those fissile materials and packages containing fissile material which are excepted in accordance with 2.7.2.3.5.
- 318 For the purposes of documentation, the proper shipping name shall be supplemented with the technical name (see 3.1.2.8). Technical names need not be shown on the package. When the infectious substances to be transported are unknown, but suspected of meeting the criteria for inclusion in category A and assignment to UN 2814 or UN 2900, the words “suspected category A infectious substance” shall be shown, in parentheses, following the proper shipping name on the transport document, but not on the outer packagings.
- 319 Substances packed and packages marked in accordance with packing instruction P650 are not subject to any other provisions of this Code.
- 321 These storage systems shall always be considered as containing hydrogen.
- 322 When transported in non-friable tablet form, these goods are assigned to packing group III.
- 323 *Deleted.*
- 324 This substance needs to be stabilized when in concentrations of not more than 99%.
- 325 In the case of non-fissile or fissile-excepted uranium hexafluoride, the material shall be classified under UN 2978.
- 326 In the case of fissile uranium hexafluoride, the material shall be classified under UN 2977.



## Chapter 3.3 – Special provisions applicable to certain substances, materials or articles

3

- 327 Waste aerosols and waste gas cartridges consigned in accordance with 5.4.1.4.3.3 may be transported under UN 1950 or UN 2037, as appropriate, for the purposes of reprocessing or disposal. They need not be protected against movement and inadvertent discharge provided that measures to prevent dangerous build-up of pressure and dangerous atmospheres are addressed. Waste aerosols, other than those leaking or severely deformed, shall be packed in accordance with packing instruction P207 and special provision PP87, or packing instruction LP200 and special packing provision L2. Waste gas cartridges, other than those leaking or severely deformed, shall be packed in accordance with packing instruction P003 and special packing provisions PP17 and PP96, or packing instruction LP200 and special packing provision L2. Leaking or severely deformed aerosols and gas cartridges shall be transported in salvage pressure receptacles or salvage packagings provided appropriate measures are taken to ensure there is no dangerous build-up of pressure. Waste aerosols and waste gas cartridges shall not be transported in closed freight containers.
- Waste gas cartridges that were filled with gases of class 2.2 and have been pierced are not subject to this Code.
- 328 This entry applies to fuel cell cartridges, including when contained in equipment or packed with equipment. Fuel cell cartridges installed in or integral to a fuel cell system are regarded as contained in equipment. "Fuel cell cartridge" means an article that stores fuel for discharge into the fuel cell through a valve(s) that controls the discharge of fuel into the fuel cell. Fuel cell cartridges, including when contained in equipment, shall be designed and constructed to prevent fuel leakage under normal conditions of transport.
- Fuel cell cartridge design types using liquids as fuels shall pass an internal pressure test at a pressure of 100 kPa (gauge) without leakage.
- Except for fuel cell cartridges containing hydrogen in metal hydride, which shall be in compliance with special provision 339, each fuel cell cartridge design type shall be shown to pass a 1.2 m drop test onto an unyielding surface, in the orientation most likely to result in failure of the containment system, with no loss of contents.
- △ When lithium metal, lithium ion or sodium ion batteries are contained in the fuel cell system, the consignment shall be consigned under this entry and under the appropriate entries for UN 3091 LITHIUM METAL BATTERIES CONTAINED IN EQUIPMENT, UN 3481 LITHIUM ION BATTERIES CONTAINED IN EQUIPMENT or UN 3552 SODIUM ION BATTERIES CONTAINED IN EQUIPMENT.
- 332 Magnesium nitrate hexahydrate is not subject to the provisions of this Code.
- 333 Ethanol and gasoline, motor spirit or petrol mixtures for use in spark-ignition engines (e.g. in automobiles, stationary engines and other engines) shall be assigned to this entry regardless of variations in volatility.
- 334 A fuel cell cartridge may contain an activator provided it is fitted with two independent means of preventing unintended mixing with the fuel during transport.
- 335 Mixtures of solids which are not subject to the provisions of this Code and environmentally hazardous liquids assigned to UN 3082 may be classified and transported as UN 3077, provided there is no free liquid visible at the time the substance is loaded or at the time the packaging or cargo transport unit is closed. If free liquid is visible at the time the mixture is loaded or at the time the packaging or cargo transport unit is closed, the mixture shall be classified as UN 3082. Each cargo transport unit shall be leakproof when used as a bulk container. Sealed packets and articles containing less than 10 mL of an environmentally hazardous liquid assigned to UN 3082, absorbed into a solid material but with no free liquid in the packet or article, or containing less than 10 g of an environmentally hazardous solid assigned to UN 3077, are not subject to the provisions of this Code.
- 338 Each fuel cell cartridge transported under this entry and designed to contain a liquefied flammable gas shall:
- .1 be capable of withstanding, without leakage or bursting, a pressure of at least two times the equilibrium pressure of the contents at 55°C;
  - .2 not contain more than 200 mL liquefied flammable gas, the vapour pressure of which shall not exceed 1 000 kPa at 55°C; and
  - .3 pass the hot water bath test prescribed in 6.2.4.1 of chapter 6.2.
- 339 Fuel cell cartridges containing hydrogen in a metal hydride transported under this entry shall have a water capacity less than or equal to 120 mL. The pressure in the fuel cell cartridge shall not exceed 5 MPa at 55°C. The design type shall withstand, without leaking or bursting, a pressure of two (2) times the design pressure of the cartridge at 55°C or 200 kPa more than the design pressure of the cartridge at 55°C, whichever is greater. The pressure at which this test is conducted is referred to in the Drop Test and the Hydrogen Cycling Test as the "minimum shell burst pressure".



**Part 3 – Dangerous Goods List, special provisions and exceptions**

3

Fuel cell cartridges shall be filled in accordance with procedures provided by the manufacturer. The manufacturer shall provide the following information with each fuel cell cartridge:

- .1 Inspection procedures to be carried out before initial filling and before refilling of the fuel cell cartridge;
- .2 Safety precautions and potential hazards to be aware of;
- .3 Method for determining when the rated capacity has been achieved;
- .4 Minimum and maximum pressure range;
- .5 Minimum and maximum temperature range; and
- .6 Any other requirements to be met for initial filling and refilling, including the type of equipment to be used for initial filling and refilling.

The fuel cell cartridges shall be designed and constructed to prevent fuel leakage under normal conditions of transport. Each cartridge design type, including cartridges integral to a fuel cell, shall be subjected to and shall pass the following tests:

**Drop test**

A 1.8 m drop test onto an unyielding surface in four different orientations:

- .1 Vertically, on the end containing the shut-off valve assembly;
- .2 Vertically, on the end opposite to the shut-off valve assembly;
- .3 Horizontally, onto a steel apex with a diameter of 38 mm, with the steel apex in the upward position; and
- .4 At a 45° angle on the end containing the shut-off valve assembly.

There shall be no leakage, determined by using a soap bubble solution or other equivalent means on all possible leak locations, when the cartridge is charged to its rated charging pressure. The fuel cell cartridge shall then be hydrostatically pressurized to destruction. The recorded burst pressure shall exceed 85% of the minimum shell burst pressure.

**Fire test**

A fuel cell cartridge filled to rated capacity with hydrogen shall be subjected to a fire engulfment test. The cartridge design, which may include a vent feature integral to it, is deemed to have passed the fire test if:

- .1 The internal pressure vents to zero gauge pressure without rupture of the cartridge; or
- .2 The cartridge withstands the fire for a minimum of 20 minutes without rupture.

**Hydrogen cycling test**

This test is intended to ensure that a fuel cell cartridge design stress limits are not exceeded during use.

The fuel cell cartridge shall be cycled from not more than 5% rated hydrogen capacity to not less than 95% rated hydrogen capacity and back to not more than 5% rated hydrogen capacity. The rated charging pressure shall be used for charging and temperatures shall be held within the operating temperature range. The cycling shall be continued for at least 100 cycles.

Following the cycling test, the fuel cell cartridge shall be charged and the water volume displaced by the cartridge shall be measured. The cartridge design is deemed to have passed the hydrogen cycling test if the water volume displaced by the cycled cartridge does not exceed the water volume displaced by an uncycled cartridge charged to 95% rated capacity and pressurized to 75% of its minimum shell burst pressure.

**Production leak test**

Each fuel cell cartridge shall be tested for leaks at 15°C ± 5°C, while pressurized to its rated charging pressure. There shall be no leakage, determined by using a soap bubble solution or other equivalent means on all possible leak locations.

Each fuel cell cartridge shall be permanently marked with the following information:

- .1 The rated charging pressure in megapascals (MPa);
- .2 The manufacturer's serial number of the fuel cell cartridges or unique identification number; and
- .3 The date of expiry based on the maximum service life (year in four digits; month in two digits).

340 Chemical kits, first aid kits and polyester resin kits containing dangerous substances in inner packagings which do not exceed the quantity limits for excepted quantities applicable to individual substances as specified in column 7b of the Dangerous Goods List may be transported in accordance with chapter 3.5. Class 5.2 substances, although not individually authorized as excepted quantities in the Dangerous Goods List, are authorized in such kits and are assigned code E2 (see 3.5.1.2).

341 Bulk transport of infectious substances in BK2 bulk containers is only permitted for infectious substances contained in animal material as defined in 1.2.1 (see 4.3.2.4.1).

## Chapter 3.3 – Special provisions applicable to certain substances, materials or articles

3

- 342 Glass inner receptacles (such as ampoules or capsules) intended only for use in sterilization devices, when containing less than 30 mL of ethylene oxide per inner packaging with not more than 300 mL per outer packaging, may be transported in accordance with the provisions in chapter 3.5, irrespective of the indication of “E0” in column 7b of the Dangerous Goods List provided that:
- .1 After filling, each glass inner receptacle has been determined to be leak tight by placing the glass inner receptacle in a hot water bath at a temperature, and for a period of time, sufficient to ensure that an internal pressure equal to the vapour pressure of ethylene oxide at 55°C is achieved. Any glass inner receptacle showing evidence of leakage, distortion or other defect under this test shall not be transported under the terms of this special provision;
  - .2 In addition to the packaging required by 3.5.2, each glass inner receptacle is placed in a sealed plastics bag compatible with ethylene oxide and capable of containing the contents in the event of breakage or leakage of the glass inner receptacle; and
  - .3 Each glass inner receptacle is protected by a means of preventing puncture of the plastics bag (e.g. sleeves or cushioning) in the event of damage to the packaging (e.g. by crushing).
- 343 This entry applies to crude oil containing hydrogen sulphide in sufficient concentration that vapours evolved from the crude oil can present an inhalation hazard. The packing group assigned shall be determined by the flammability hazard and inhalation hazard, in accordance with the degree of danger presented.
- 344 The provisions of 6.2.4 shall be met.
- 345 This gas contained in open cryogenic receptacles with a maximum capacity of 1 L constructed with glass double walls having the space between the inner and outer wall evacuated (vacuum insulated) is not subject to the provisions of this Code provided each receptacle is transported in an outer packaging with suitable cushioning or absorbent materials to protect it from impact damage.
- 346 Open cryogenic receptacles conforming to the requirements of packing instruction P203 and containing no dangerous goods except for UN 1977, nitrogen, refrigerated liquid, which is fully absorbed in a porous material, are not subject to any other provisions of this Code.
- 347 This entry shall only be used if the results of test series 6(d) of part I of the *Manual of Tests and Criteria* have demonstrated that any hazardous effects arising from functioning are confined within the package.
- △ 348 Lithium batteries manufactured after 31 December 2011 and sodium ion batteries manufactured after 31 December 2025 shall be marked with the Watt hour rating on the outside case.
- 349 Mixtures of a hypochlorite with an ammonium salt are not to be accepted for transport. UN 1791 hypochlorite solution is a substance of class 8.
- 350 Ammonium bromate and its aqueous solutions and mixtures of a bromate with an ammonium salt are not to be accepted for transport.
- 351 Ammonium chlorate and its aqueous solutions and mixtures of a chlorate with an ammonium salt are not to be accepted for transport.
- 352 Ammonium chlorite and its aqueous solutions and mixtures of a chlorite with an ammonium salt are not to be accepted for transport.
- 353 Ammonium permanganate and its aqueous solutions and mixtures of a permanganate with an ammonium salt are not to be accepted for transport.
- 354 This substance is toxic by inhalation.
- 355 Oxygen cylinders for emergency use transported under this entry may include installed actuating cartridges (cartridges, power device of class 1.4, compatibility group C or S), without changing the classification of class 2.2 provided the total quantity of deflagrating (propellant) explosives does not exceed 3.2 g per oxygen cylinder. The cylinders with the installed actuating cartridges as prepared for transport shall have an effective means of preventing inadvertent activation.
- 356 Metal hydride storage systems installed in vehicles, vessels, machinery, engines or aircraft or in completed components or intended to be installed in vehicles, vessels, machinery, engines or aircraft shall be approved by the competent authority before acceptance for transport. The transport document shall include an indication that the package was approved by the competent authority or a copy of the competent authority approval shall accompany each consignment.
- 357 Petroleum crude oil containing hydrogen sulphide in sufficient concentration that vapours evolved from the crude oil can present an inhalation hazard shall be consigned under the entry UN 3494 PETROLEUM SOUR CRUDE OIL, FLAMMABLE, TOXIC.
- 358 Nitroglycerin solution in alcohol with more than 1% but not more than 5% nitroglycerin may be classified in class 3 and assigned to UN 3064 provided all the requirements of packing instruction P300 are complied with.

## Part 3 – Dangerous Goods List, special provisions and exceptions

3

- 359 Nitroglycerin solution in alcohol with more than 1% but not more than 5% nitroglycerin shall be classified in class 1 and assigned to UN 0144 if not all the requirements of packing instruction P300 are complied with.
- △ 360 Vehicles only powered by lithium metal, lithium ion or sodium ion batteries shall be assigned to the entries UN 3556 VEHICLE, LITHIUM ION BATTERY POWERED or UN 3557 VEHICLE, LITHIUM METAL BATTERY POWERED or UN 3558 VEHICLE, SODIUM ION BATTERY POWERED, as applicable. Lithium batteries installed in cargo transport units, designed only to provide power external to the transport unit shall be assigned to entry UN 3536 LITHIUM BATTERIES INSTALLED IN CARGO TRANSPORT UNIT.
- 361 This entry applies to electric double layer capacitors with an energy storage capacity greater than 0.3 Wh. Capacitors with an energy storage capacity of 0.3 Wh or less are not subject to the provisions of this Code. Energy storage capacity means the energy held by a capacitor, as calculated using the nominal voltage and capacitance. All capacitors to which this entry applies, including capacitors containing an electrolyte that does not meet the classification criteria of any class or division of dangerous goods, shall meet the following conditions:
- .1 Capacitors not installed in equipment shall be transported in an uncharged state. Capacitors installed in equipment shall be transported either in an uncharged state or protected against short circuit;
  - .2 Each capacitor shall be protected against a potential short circuit hazard in transport as follows:
    - .1 when a capacitor's energy storage capacity is less than or equal to 10 Wh or when the energy storage capacity of each capacitor in a module is less than or equal to 10 Wh, the capacitor or module shall be protected against short circuit or be fitted with a metal strap connecting the terminals; and
    - .2 when the energy storage capacity of a capacitor or a capacitor in a module is more than 10 Wh, the capacitor or module shall be fitted with a metal strap connecting the terminals;
  - .3 Capacitors containing dangerous goods shall be designed to withstand a 95 kPa pressure differential;
  - .4 Capacitors shall be designed and constructed to safely relieve pressure that may build up in use, through a vent or a weak point in the capacitor casing. Any liquid which is released upon venting shall be contained by the packaging or by the equipment in which a capacitor is installed; and
  - .5 Capacitors manufactured after 31 December 2013 shall be marked with the energy storage capacity in Wh.
- Capacitors containing an electrolyte not meeting the classification criteria of any class or division of dangerous goods, including when installed in equipment, are not subject to other provisions of this Code.
- Capacitors containing an electrolyte meeting the classification criteria of any class or division of dangerous goods, with an energy storage capacity of 10 Wh or less are not subject to other provisions of this Code when they are capable of withstanding a 1.2 m drop test unpackaged on an unyielding surface without loss of contents.
- Capacitors containing an electrolyte meeting the classification criteria of any class or division of dangerous goods that are not installed in equipment and with an energy storage capacity of more than 10 Wh are subject to the provisions of this Code.
- Capacitors installed in the equipment and containing an electrolyte meeting the classification criteria of any class or division of dangerous goods, are not subject to other provisions of this Code provided the equipment is packaged in a strong outer packaging constructed of suitable material and of adequate strength and design, in relation to the packaging's intended use and in such a manner as to prevent accidental functioning of capacitors during transport. Large robust equipment containing capacitors may be offered for transport unpackaged or on pallets when capacitors are afforded equivalent protection by the equipment in which they are contained.
- Note:** Capacitors which by design maintain a terminal voltage (e.g. asymmetrical capacitors) do not belong to this entry.
- 362 This entry applies to liquids, pastes or powders, pressurized with a propellant which meets the definition of a gas in 2.2.1.1 and 2.2.1.2.1 or 2.2.1.2.2.
- Note:** A chemical under pressure in an aerosol dispenser shall be transported under UN 1950.
- The following provisions shall apply:
- .1 the chemical under pressure shall be classified based on the hazard characteristics of the components in the different states:
    - the propellant;

## Chapter 3.3 – Special provisions applicable to certain substances, materials or articles

3

- the liquid; or
- the solid.

If one of these components, which can be a pure substance or a mixture, needs to be classified as flammable, the chemical under pressure shall be classified as flammable in class 2.1. Flammable components are flammable liquids and liquid mixtures, flammable solids and solid mixtures or flammable gases and gas mixtures meeting the following criteria:

- .1 a flammable liquid is a liquid having a flashpoint of not more than 93°C;
- .2 a flammable solid is a solid which meets the criteria in 2.4.2.2 of this Code;
- .3 a flammable gas is a gas which meets the criteria in 2.2.2.1 of this Code;
- .2 gases of class 2.3 and gases with a subsidiary hazard of 5.1 shall not be used as a propellant in a chemical under pressure;
- .3 where the liquid or solid components are classified as dangerous goods of class 6.1, packing groups II or III, or class 8, packing groups II or III, the chemical under pressure shall be assigned a subsidiary hazard of class 6.1 or class 8 and the appropriate UN number shall be assigned. Components classified in class 6.1, packing group I, or class 8, packing group I, shall not be used for transport under this proper shipping name;
- .4 in addition, chemicals under pressure with components meeting the properties of: class 1, explosives; class 3, liquid desensitized explosives; class 4.1, self-reactive substances and solid desensitized explosives; class 4.2, substances liable to spontaneous combustion; class 4.3, substances which, in contact with water, emit flammable gases; class 5.1, oxidizing substances; class 5.2, organic peroxides; class 6.2, Infectious substances or class 7, Radioactive material, shall not be used for transport under this proper shipping name;
- .5 substances to which PP86 or TP7 are assigned in column 9 and column 14 of the Dangerous Goods List in chapter 3.2 and therefore require air to be eliminated from the vapour space, shall not be used for transport under this UN number but shall be transported under their respective UN numbers as listed in the Dangerous Goods List of chapter 3.2.

363 This entry may only be used when the conditions of this special provision are met. No other provisions of this Code apply, except for special provision 972, chapter 5.4, part 7 and column 16a and 16b of the Dangerous Goods List.

- .1 This entry applies to engines or machinery, powered by fuels classified as dangerous goods via internal combustion systems or fuel cells (e.g. combustion engines, generators, compressors, turbines, heating units, etc.), except those which are assigned under UN 3166 or UN 3363;
- .2 Engines or machinery which are empty of liquid or gaseous fuels and which do not contain other dangerous goods, are not subject to this Code.

**Note 1:** An engine or machinery is considered to be empty of liquid fuel when the liquid fuel tank has been drained and the engine or machinery cannot be operated due to a lack of fuel. Engine or machinery components such as fuel lines, fuel filters and injectors do not need to be cleaned, drained or purged to be considered empty of liquid fuels. In addition, the liquid fuel tank does not need to be cleaned or purged.

**Note 2:** An engine or machinery is considered to be empty of gaseous fuels when the gaseous fuel tanks are empty of liquid (for liquefied gases), the positive pressure in the tanks does not exceed 2 bar and the fuel shut-off or isolation valve is closed and secured.

- .3 Engines and machinery containing fuels meeting the classification criteria of class 3, shall be consigned under the entries UN No. 3528 ENGINE, INTERNAL COMBUSTION, FLAMMABLE LIQUID POWERED or UN 3528 ENGINE, FUEL CELL, FLAMMABLE LIQUID POWERED or UN 3528 MACHINERY, INTERNAL COMBUSTION, FLAMMABLE LIQUID POWERED or UN 3528 MACHINERY, FUEL CELL, FLAMMABLE LIQUID POWERED, as appropriate.
- .4 Engines and machinery containing fuels meeting the classification criteria of class 2.1, shall be consigned under the entries UN 3529 ENGINE, INTERNAL COMBUSTION, FLAMMABLE GAS POWERED or UN 3529 ENGINE, FUEL CELL, FLAMMABLE GAS POWERED or UN 3529 MACHINERY, INTERNAL COMBUSTION, FLAMMABLE GAS POWERED or UN 3529 MACHINERY, FUEL CELL, FLAMMABLE GAS POWERED, as appropriate.

Engines and machinery powered by both a flammable gas and a flammable liquid shall be consigned under the appropriate UN 3529 entry.

- .5 Engines and machinery containing liquid fuels meeting the classification criteria of 2.9.3 for environmentally hazardous substances and not meeting the classification criteria of any other class or division, shall be consigned under the entries UN 3530 ENGINE, INTERNAL COMBUSTION or UN 3530 MACHINERY, INTERNAL COMBUSTION, as appropriate.
- .6 Engines or machinery may contain other dangerous goods than fuels (e.g. batteries, fire extinguishers, compressed gas accumulators or safety devices) required for their functioning or

## Part 3 – Dangerous Goods List, special provisions and exceptions

3

safe operation without being subject to any additional requirements for these other dangerous goods, unless otherwise specified in this Code.

- .7 The engine or machinery, including the means of containment containing dangerous goods, shall be in compliance with the construction requirements specified by the competent authority.
- .8 Any valves or openings (e.g. venting devices) shall be closed during transport.
- .9 The engines or machinery shall be oriented to prevent inadvertent leakage of dangerous goods and secured by means capable of restraining the engines or machinery to prevent any movement during transport which would change the orientation or cause them to be damaged.
- .10 For UN 3528 and UN 3530:
- where the engine or machinery contains more than 60 L of liquid fuel and has a capacity of not more than 450 L, the labelling requirements of 5.2.2 shall apply;
  - where the engine or machinery contains more than 60 L of liquid fuel and has a capacity of more than 450 L but not more than 3,000 L, it shall be labelled on two opposing sides in accordance with 5.2.2;
  - where the engine or machinery contains more than 60 L of liquid fuel and has a capacity of more than 3,000 L, it shall be placarded on two opposing sides. Placards shall correspond to the class indicated in column 3 of the Dangerous Goods List of chapter 3.2 and shall conform to the specifications given in 5.3.1.2.1;
  - in addition to the above requirements, for UN 3530, where the engine or machinery contains more than 60 L of liquid fuel and the capacity does not exceed 3,000 L, the marking requirements of 5.2.1.6 apply; and where the engine or machinery contains more than 60 L of liquid fuel and the capacity exceeds 3,000 L, the marking requirements of 5.3.2.3.2 apply.
- .11 For UN 3529:
- where the fuel tank of the engine or machinery has a water capacity of not more than 450 L, the labelling requirements of 5.2.2 shall apply;
  - where the fuel tank of the engine or machinery has a water capacity of more than 450 L but not more than 1,000 L, it shall be labelled on two opposing sides in accordance with 5.2.2; and
  - where the fuel tank of the engine or machinery has a water capacity of more than 1,000 L, it shall be placarded on two opposing sides. Placards shall correspond to the class indicated in Column 3 of the Dangerous Goods List in Chapter 3.2 and shall conform to the specifications given in 5.3.1.2.1.
- .12 The transport document shall contain the following additional statement “Transport in accordance with special provision 363”.
- .13 The requirements specified in packing instruction P005 of 4.1.4.1 shall be met.
- 364 This article may only be transported under the provisions of chapter 3.4 if, as presented for transport, the package is capable of passing the test in accordance with test series 6(d) of part I of the *Manual of Tests and Criteria* as determined by the competent authority.
- △ 365 For manufactured instruments and articles containing mercury or gallium, see UN Nos. 3506 or 3554, as appropriate.
- △ 366 Manufactured instruments and articles containing not more than 1 kg of mercury or gallium are not subject to the provisions of this Code.
- 367 For the purposes of documentation and package marking:
- The proper shipping name “PAINT RELATED MATERIAL” may be used for consignments of packages containing “PAINT” and “PAINT RELATED MATERIAL” in the same package;
- The proper shipping name “PAINT RELATED MATERIAL, CORROSIVE, FLAMMABLE” may be used for consignments of packages containing “PAINT, CORROSIVE, FLAMMABLE” and “PAINT RELATED MATERIAL, CORROSIVE, FLAMMABLE” in the same package;
- The proper shipping name “PAINT RELATED MATERIAL, FLAMMABLE, CORROSIVE” may be used for consignments of packages containing “PAINT, FLAMMABLE, CORROSIVE” and “PAINT RELATED MATERIAL, FLAMMABLE, CORROSIVE” in the same package; and
- The proper shipping name “PRINTING INK RELATED MATERIAL” may be used for consignments of packages containing “PRINTING INK” and “PRINTING INK RELATED MATERIAL” in the same package.
- 368 In the case of non-fissile or fissile-excepted uranium hexafluoride, the material shall be classified under UN 3507 or UN 2978.
- 369 In accordance with 2.0.3.5, this radioactive material in an excepted package possessing toxic and corrosive properties is classified in class 6.1 with radioactivity and corrosivity subsidiary hazards.



## Chapter 3.3 – Special provisions applicable to certain substances, materials or articles

3

Uranium hexafluoride may be classified under this entry only if the conditions of 2.7.2.4.1.2, 2.7.2.4.1.5, 2.7.2.4.5.2 and, for fissile-excepted material, of 2.7.2.3.5 are met.

In addition to the provisions applicable to the transport of class 6.1 substances with a corrosivity subsidiary hazard, the provisions of 5.1.3.2, 5.1.5.2.2, 5.1.5.4.1.2, 7.1.4.5.9, 7.1.4.5.10, 7.1.4.5.12, and 7.8.4.1 to 7.8.4.6 shall apply.

No class 7 label is required to be displayed.

- 370 This entry only applies to ammonium nitrate that meets one of the following criteria:
- ammonium nitrate with more than 0.2% combustible substances, including any organic substance calculated as carbon, to the exclusion of any added substance; or
  - ammonium nitrate with not more than 0.2% combustible substances, including any organic substance calculated as carbon, to the exclusion of any added substance, that gives a positive result when tested in accordance with test series 2 (see *Manual of Tests and Criteria*, part I). See also UN 1942.

This entry shall not be used for ammonium nitrate for which a proper shipping name already exists in the Dangerous Goods List of chapter 3.2 including ammonium nitrate mixed with fuel oil (ANFO) or any of the commercial grades of ammonium nitrate.

- 371 .1 This entry also applies to articles, containing a small pressure receptacle with a release device. Such articles shall comply with the following requirements:
- .1 the water capacity of the pressure receptacle shall not exceed 0.5 L and the working pressure shall not exceed 25 bar at 15°C;
  - .2 the minimum burst pressure of the pressure receptacle shall be at least four times the pressure of the gas at 15°C;
  - .3 each article shall be manufactured in such a way that unintentional firing or release is avoided under normal conditions of handling, packing, transport and use. This may be fulfilled by an additional locking device linked to the activator;
  - .4 each article shall be manufactured in such a way as to prevent hazardous projections of the pressure receptacle or parts of the pressure receptacle;
  - .5 each pressure receptacle shall be manufactured from material which will not fragment upon rupture;
  - △ .6 the design type of the article shall be subjected to a fire test. For this test, the provisions of paragraphs 16.6.1.2 except subparagraph (g), 16.6.1.3.1 to 16.6.1.3.4, 16.6.1.3.6, 16.6.1.3.7(b) and 16.6.1.3.8 of the *Manual of Tests and Criteria* shall be applied. It shall be demonstrated that the article relieves its pressure by means of a fire degradable seal or other pressure relief device, in such a way that the pressure receptacle will not fragment and that the article or fragments of the article do not rocket more than 10 m; and
  - .7 the design type of the article shall be subjected to the following test. A stimulating mechanism shall be used to initiate one article in the middle of the packaging. There shall be no hazardous effects outside the package such as disruption of the package, metal fragments or a receptacle which passes through the packaging.
- .2 The manufacturer shall produce technical documentation of the design type, manufacture as well as the tests and their results. The manufacturer shall apply procedures to ensure that articles produced in series are made of good quality, conform to the design type and are able to meet the requirements in .1. The manufacturer shall provide such information to the competent authority on request.

- 372 This entry applies to asymmetric capacitors with an energy storage capacity greater than 0.3 Wh. Capacitors with an energy storage capacity of 0.3 Wh or less are not subject to the provisions of this Code.

Energy storage capacity means the energy stored in a capacitor, as calculated according to the following equation:

$$\text{Wh} = \frac{\frac{1}{2} C_N (U_R^2 - U_L^2)}{3,600}$$

using the nominal capacitance ( $C_N$ ), rated voltage ( $U_R$ ) and rated lower limit voltage ( $U_L$ ).

All asymmetric capacitors to which this entry applies shall meet the following conditions:

- .1 capacitors or modules shall be protected against short circuit;
- .2 capacitors shall be designed and constructed to safely relieve pressure that may build up in use, through a vent or a weak point in the capacitor casing. Any liquid which is released upon venting shall be contained by packaging or by equipment in which a capacitor is installed;
- .3 capacitors manufactured after 31 December 2015 shall be marked with the energy storage capacity in Wh;



- .4 capacitors containing an electrolyte meeting the classification criteria of any class or division of dangerous goods shall be designed to withstand a 95 kPa pressure differential;

Capacitors containing an electrolyte not meeting the classification criteria of any class or division of dangerous goods, including when configured in a module or when installed in equipment are not subject to other provisions of this Code. Capacitors containing an electrolyte meeting the classification criteria of any class or division of dangerous goods, with an energy storage capacity of 20 Wh or less, including when configured in a module, are not subject to other provisions of this Code when the capacitors are capable of withstanding a 1.2 m drop test unpackaged on an unyielding surface without loss of contents.

Capacitors containing an electrolyte meeting the classification criteria of any class or division of dangerous goods that are not installed in equipment and with an energy storage capacity of more than 20 Wh are subject to this Code.

Capacitors installed in equipment and containing an electrolyte meeting the classification criteria of any class or division of dangerous goods, are not subject to other provisions of this Code provided that the equipment is packaged in a strong outer packaging constructed of suitable material, and of adequate strength and design, in relation to the packaging's intended use and in such a manner as to prevent accidental functioning of capacitors during transport. Large robust equipment containing capacitors may be offered for transport unpackaged or on pallets when capacitors are afforded equivalent protection by the equipment in which they are contained.

**Note:** Notwithstanding the provisions of this special provision, nickel-carbon asymmetric capacitors containing class 8 alkaline electrolytes shall be transported as UN 2795, BATTERIES, WET, FILLED WITH ALKALI, electric storage.

- 373 Neutron radiation detectors containing non-pressurized boron trifluoride gas may be transported under this entry provided that the following conditions are met:

- .1 Each radiation detector shall meet the following conditions:
- .1 the pressure in each detector shall not exceed 105 kPa absolute at 20°C;
  - .2 the amount of gas shall not exceed 13 g per detector;
  - .3 each detector shall be manufactured under a registered quality assurance programme;
- Note:** The application of ISO 9001:2008 may be considered acceptable for this purpose.
- .4 each neutron radiation detector shall be of welded metal construction with brazed metal to ceramic feed through assemblies. These detectors shall have a minimum burst pressure of 1,800 kPa as demonstrated by design type qualification testing; and
  - .5 each detector shall be tested to a  $1 \times 10^{-10}$  cm<sup>3</sup>/s leak tightness standard before filling.
- .2 Radiation detectors transported as individual components shall be transported as follows:
- .1 detectors shall be packed in a sealed intermediate plastics liner with sufficient absorbent or adsorbent material to absorb or adsorb the entire gas contents;
  - .2 they shall be packed in strong outer packaging. The completed package shall be capable of withstanding a 1.8 m drop test without leakage of gas contents from detectors; and
  - .3 the total amount of gas from all detectors per outer packaging shall not exceed 52 g.
- .3 Completed neutron radiation detection systems containing detectors meeting the conditions of .1 shall be transported as follows:
- .1 the detectors shall be contained in a strong sealed outer casing;
  - .2 the casing shall contain sufficient absorbent or adsorbent material to absorb or adsorb the entire gas contents; and
  - .3 the completed systems shall be packed in strong outer packagings capable of withstanding a 1.8 m drop test without leakage unless a system's outer casing affords equivalent protection.

Packing instruction P200 of 4.1.4.1 is not applicable.

The transport document shall include the statement "Transport in accordance with special provision 373".

Neutron radiation detectors containing not more than 1 g of boron trifluoride, including those with solder glass joints, are not subject to this Code provided they meet the requirements in paragraph .1 and are packed in accordance with paragraph .2. Radiation detection systems containing such detectors are not subject to this Code provided they are packed in accordance with paragraph .3.

Neutron radiation detectors shall be stowed in accordance with stowage Category A.

- 375 These substances, when carried in single or combination packagings containing a net quantity per single or inner packaging of 5 L or less for liquids or having a net mass per single or inner packaging of 5 kg or less for solids, are not subject to any other provisions of the present Code, provided the packagings meet the general provisions of 4.1.1.1, 4.1.1.2 and 4.1.1.4 to 4.1.1.8.

## Chapter 3.3 – Special provisions applicable to certain substances, materials or articles

3

- △ 376 Lithium metal, lithium ion or sodium ion cells or batteries identified as being damaged or defective such that they do not conform to the type tested according to the applicable provisions of the *Manual of Tests and Criteria* shall comply with the requirements of this special provision.
- For the purposes of this special provision, these may include, but are not limited to:
- Cells or batteries identified as being defective for safety reasons;
  - Cells or batteries that have leaked or vented;
  - Cells or batteries that cannot be diagnosed prior to transport; or
  - Cells or batteries that have sustained physical or mechanical damage.
- Note:** In assessing a cell or battery as damaged or defective, an assessment or evaluation shall be performed based on safety criteria from the cell, battery or product manufacturer or by a technical expert with knowledge of the cell's or battery's safety features. An assessment or evaluation may include, but is not limited to, the following criteria:
- .1 acute hazard, such as gas, fire or electrolyte leaking;
  - .2 the use or misuse of the cell or battery;
  - .3 signs of physical damage, such as deformation to cell or battery casing, or colours on the casing;
  - .4 external and internal short circuit protection, such as voltage or isolation measures;
  - .5 the condition of the cell or battery safety features; or
  - .6 damage to any internal safety components, such as the battery management system.
- △ Cells and batteries shall be transported according to the provisions applicable to UN 3090, UN 3091, UN 3480, UN 3481, UN 3551 and UN 3552, as appropriate, except special provision 230 and as otherwise stated in this special provision.
- Cells and batteries shall be packed in accordance with packing instructions P908 of 4.1.4.1 or LP904 of 4.1.4.3, as applicable.
- Cells and batteries identified as damaged or defective and liable to rapidly disassemble, dangerously react, produce a flame or a dangerous evolution of heat or a dangerous emission of toxic, corrosive or flammable gases or vapours under normal conditions of transport shall be packed and transported in accordance with packing instruction P911 of 4.1.4.1 or LP906 of 4.1.4.3, as applicable. Alternative packing and/or transport conditions may be authorized by the competent authority.
- Packages shall be marked "DAMAGED/DEFECTIVE" in addition to the proper shipping name, as stated in 5.2.1.
- The transport document shall include the following statement "Transport in accordance with special provision 376".
- If applicable, a copy of the competent authority approval shall accompany the transport.
- △ 377 Lithium metal, lithium ion and sodium ion cells and batteries and equipment containing such cells and batteries transported for disposal or recycling, either packed together with or packed without non-lithium or non-sodium ion batteries, may be packaged in accordance with packing instruction P909 of 4.1.4.1.
- △ These cells and batteries are not subject to the requirements of section 2.9.4 or 2.9.5.
- △ Packages shall be marked "LITHIUM BATTERIES FOR DISPOSAL", "SODIUM ION BATTERIES FOR DISPOSAL", "LITHIUM BATTERIES FOR RECYCLING", or "SODIUM ION BATTERIES FOR RECYCLING", as appropriate.
- Identified damaged or defective batteries shall be transported in accordance with special provision 376.
- The transport document shall include the following statement: "Transport in accordance with special provision 377".
- 378 Radiation detectors containing this gas in non-refillable pressure receptacles not meeting the requirements of chapter 6.2 and packing instruction P200 of 4.1.4.1 may be transported under this entry provided:
- .1 The working pressure in each receptacle does not exceed 50 bar;
  - .2 The receptacle capacity does not exceed 12 L;
  - .3 Each receptacle has a minimum burst pressure of at least 3 times the working pressure when a relief device is fitted and at least 4 times the working pressure when no relief device is fitted;
  - .4 Each receptacle is manufactured from material which will not fragment upon rupture;
  - .5 Each detector is manufactured under a registered quality assurance programme;
- Note:** ISO 9001:2008 may be used for this purpose.

## Part 3 – Dangerous Goods List, special provisions and exceptions

3

- .6 Detectors are transported in strong outer packagings. The complete package shall be capable of withstanding a 1.2 metre drop test without breakage of the detector or rupture of the outer packaging. Equipment that includes a detector shall be packed in a strong outer packaging unless the detector is afforded equivalent protection by the equipment in which it is contained; and
- .7 The transport document includes the following statement “Transport in accordance with special provision 378”.

Radiation detectors, including detectors in radiation detection systems, are not subject to any other requirements of this Code if the detectors meet the requirements in .1 to .6 above and the capacity of detector receptacles does not exceed 50 ml.

- △ 379 Anhydrous ammonia adsorbed on a solid or absorbed in a solid contained in ammonia dispensing systems or receptacles intended to form part of such systems are not subject to the other provisions of this Code if the following conditions are observed:
  - .1 The adsorption or absorption presents the following properties:
    - .1 the pressure at a temperature of 20°C in the receptacle is less than 0.6 bar;
    - .2 the pressure at a temperature of 35°C in the receptacle is less than 1 bar;
    - .3 the pressure at a temperature of 85°C in the receptacle is less than 12 bar;
  - .2 The adsorbent or absorbent material shall not have dangerous properties listed in classes 1 to 8;
  - .3 The maximum contents of a receptacle shall be 10 kg of ammonia; and
  - .4 Receptacles containing adsorbed or absorbed ammonia shall meet the following conditions:
    - △ .1 receptacles shall be made of a material compatible with ammonia as specified in ISO 11114-1:2020;
    - .2 receptacles and their means of closure shall be hermetically sealed and able to contain the generated ammonia;
    - .3 each receptacle shall be able to withstand the pressure generated at 85°C with a volumetric expansion no greater than 0.1%;
    - .4 each receptacle shall be fitted with a device that allows for gas evacuation once pressure exceeds 15 bar without violent rupture, explosion or projection; and
    - .5 each receptacle shall be able to withstand a pressure of 20 bar without leakage when the pressure relief device is deactivated.

When transported in an ammonia dispenser, the receptacles shall be connected to the dispenser in such a way that the assembly is guaranteed to have the same strength as a single receptacle.

The properties of mechanical strength mentioned in this special provision shall be tested using a prototype of a receptacle and/or dispenser filled to nominal capacity, by increasing the temperature until the specified pressures are reached.

The test results shall be documented, shall be traceable and shall be communicated to the relevant authorities upon request.

- 381 Large packagings conforming to the packing group III performance level used in accordance with packing instruction LP02 of 4.1.4.3, as prescribed in the IMDG Code (amendment 37-14), may be used until 31 December 2022.
- 382 Polymeric beads may be made from polystyrene, poly(methyl methacrylate) or other polymeric material. When it can be demonstrated that no flammable vapour, resulting in a flammable atmosphere, is evolved according to test U1 (Test method for substances liable to evolve flammable vapours) of part III, subsection 38.4.4 of the *Manual of Tests and Criteria*, polymeric beads, expandable, need not be classified under this UN number. This test should only be performed when declassification of a substance is considered.
- 383 Table tennis balls manufactured from celluloid are not subject to this Code where the net mass of each table tennis ball does not exceed 3.0 g and the total net mass of table tennis balls does not exceed 500 g per package.
- 384 The label to be used is Model No. 9A, see 5.2.2.2.2. However, for placarding of cargo transport units, the placard shall correspond to Model No. 9.
- 386 When substances are stabilized by temperature control, the provisions of 7.3.7 apply. When chemical stabilization is employed, the person offering the packaging, IBC or tank for transport shall ensure that the level of stabilization is sufficient to prevent the substance in the packaging, IBC or tank from dangerous polymerization at a bulk mean temperature of 50°C, or, in the case of a portable tank, 45°C. Where chemical stabilization becomes ineffective at lower temperatures within the anticipated duration of transport, temperature control is required. In making this determination factors to be taken into consideration include, but are not limited to, the capacity and geometry of the packaging, IBC or tank and the effect of any insulation present, the temperature of the substance when offered for transport, the duration of the journey and the ambient temperature conditions typically encountered

## Chapter 3.3 – Special provisions applicable to certain substances, materials or articles

3

in the journey (considering also the season of year), the effectiveness and other properties of the stabilizer employed, applicable operational controls imposed by regulation (e.g. requirements to protect from sources of heat, including other cargo transported at a temperature above ambient) and any other relevant factors.

387 Lithium batteries in conformity with 2.9.4.6 containing both primary lithium metal cells and rechargeable lithium ion cells shall be assigned to UN 3090 or 3091 as appropriate. When such batteries are transported in accordance with special provision 188, the total lithium content of all lithium metal cells contained in the battery shall not exceed 1.5 g and the total capacity of all lithium ion cells contained in the battery shall not exceed 10 Wh.

△ 388 UN 3166 entries apply to vehicles powered by flammable liquid or gas internal combustion engines or fuel cells.

Vehicles powered by a fuel cell engine shall be assigned to the entries UN 3166 VEHICLE, FUEL CELL, FLAMMABLE GAS POWERED or UN 3166 VEHICLE, FUEL CELL, FLAMMABLE LIQUID POWERED, as appropriate. These entries include hybrid electric vehicles powered by both a fuel cell and an internal combustion engine with wet batteries, sodium batteries, lithium metal batteries or lithium ion batteries, transported with the battery(ies) installed.

Other vehicles which contain an internal combustion engine shall be assigned to the entries UN 3166 VEHICLE, FLAMMABLE GAS POWERED or UN 3166 VEHICLE, FLAMMABLE LIQUID POWERED, as appropriate. These entries include hybrid electric vehicles powered by both an internal combustion engine and wet batteries, sodium batteries, lithium metal batteries or lithium ion batteries, transported with the battery(ies) installed.

If a vehicle is powered by a flammable liquid and a flammable gas internal combustion engine, it shall be assigned to UN 3166 VEHICLE, FLAMMABLE GAS POWERED.

△ Entry UN 3171 only applies to vehicles and equipment powered by wet batteries, metallic sodium batteries or sodium alloy batteries, transported with these batteries installed.

■ UN 3556 VEHICLE, LITHIUM ION BATTERY POWERED, UN 3557 VEHICLE, LITHIUM METAL BATTERY POWERED and UN 3558 VEHICLE, SODIUM ION BATTERY POWERED, as applicable, apply to vehicles powered by lithium ion, lithium metal or sodium ion batteries transported with the batteries installed.

△ For the purpose of this special provision, vehicles are self-propelled apparatus designed to carry one or more persons or goods. Examples of such vehicles are cars, motorcycles, scooters, three- and four-wheeled vehicles or motorcycles, trucks, locomotives, bicycles (pedal cycles with a motor) and other vehicles of this type (e.g. self-balancing vehicles or vehicles not equipped with at least one seating position), wheelchairs, lawn tractors, self-propelled farming and construction equipment, boats and aircraft. When vehicles are transported in a packaging, some parts of the vehicle, other than the battery, may be detached from its frame to fit into the packaging.

Examples of equipment are lawnmowers, cleaning machines or model boats and model aircraft. Equipment powered by lithium metal batteries or lithium ion batteries shall be assigned to the entries UN 3091 LITHIUM METAL BATTERIES CONTAINED IN EQUIPMENT or UN 3091 LITHIUM METAL BATTERIES PACKED WITH EQUIPMENT or UN 3481 LITHIUM ION BATTERIES CONTAINED IN EQUIPMENT or UN 3481 LITHIUM ION BATTERIES PACKED WITH EQUIPMENT, as appropriate. Lithium ion batteries or lithium metal batteries installed in a cargo transport unit and designed only to provide power external to the cargo transport unit shall be assigned to the entry UN 3536 LITHIUM BATTERIES INSTALLED IN CARGO TRANSPORT UNIT lithium ion batteries or lithium metal batteries.

Dangerous goods, such as batteries, airbags, fire extinguishers, compressed gas accumulators, safety devices and other integral components of the vehicle that are necessary for the operation of the vehicle or for the safety of its operator or passengers, shall be securely installed in the vehicle and are not otherwise subject to this Code.

■ Lithium batteries shall meet the provisions of 2.9.4, except that 2.9.4.1, 2.9.4.5.7, 2.9.4.6.3 if applicable, 2.9.4.6.4 if applicable and 2.9.4.7 do not apply when batteries of a production run of not more than 100 cells or batteries, or pre-production prototypes of cells or batteries when these prototypes are transported for testing, are installed in vehicles.

■ Where a lithium battery installed in a vehicle is damaged or defective, the battery shall be removed and transported according to SP376, unless otherwise approved by the competent authority.

389 This entry only applies to lithium ion batteries or lithium metal batteries installed in a cargo transport unit and designed only to provide power external to the cargo transport unit. The lithium batteries shall meet the requirements of 2.9.4.1 to .7 and contain the necessary systems to prevent overcharge and overdischarge between the batteries.

The batteries shall be securely attached to the interior structure of the cargo transport unit (e.g. by means of placement in racks, cabinets, etc.) in such a manner as to prevent short circuits, accidental

Part 3 – Dangerous Goods List, special provisions and exceptions

3

operation, and significant movement relative to the cargo transport unit under the shocks, loadings and vibrations normally incident to transport. Dangerous goods necessary for the safe and proper operation of the cargo transport unit (e.g. fire-extinguishing systems and air-conditioning systems), shall be properly secured to or installed in the cargo transport unit and are not otherwise subject to this Code. Dangerous goods not necessary for the safe and proper operation of the cargo transport unit shall not be transported within the cargo transport unit.

The batteries inside the cargo transport unit are not subject to marking or labelling requirements. The cargo transport unit shall display the UN number in accordance with 5.3.2.1.2 and be placarded on two opposing sides in accordance with 5.3.1.1.2.

390 When a package contains a combination of lithium batteries contained in equipment and lithium batteries packed with equipment, the following requirements apply for the purposes of package marking and documentation:

- .1 the package shall be marked “UN 3091 Lithium metal batteries packed with equipment”, or “UN 3481 Lithium ion batteries packed with equipment”, as appropriate. If a package contains both lithium ion batteries and lithium metal batteries packed with and contained in equipment, the package shall be marked as required for both battery types. However, button cell batteries installed in equipment (including circuit boards) need not be considered.
- .2 the transport document shall indicate “UN 3091 Lithium metal batteries packed with equipment” or “UN 3481 Lithium ion batteries packed with equipment”, as appropriate. If a package contains both lithium metal batteries and lithium ion batteries packed with and contained in equipment, then the transport document shall indicate both “UN 3091 Lithium metal batteries packed with equipment” and “UN 3481 Lithium ion batteries packed with equipment”

391 Articles containing dangerous goods of class 2.3, or class 4.2, or class 4.3, or class 5.1, or class 5.2 or class 6.1 for substances of inhalation toxicity requiring packing group I and articles containing more than one of the hazards listed in 2.0.3.4.2 to 2.0.3.4.4 shall be transported under conditions approved by the competent authority.

392 For the transport of fuel gas containment systems designed and approved to be fitted in motor vehicles containing this gas, the provisions of subsection 4.1.4.1 and chapter 6.2 of this Code need not be applied when transported for disposal, recycling, repair, inspection, maintenance or from where they are manufactured to a vehicle assembly plant, provided the following conditions are met:

- .1 The fuel gas containment systems shall meet the requirements of the standards or regulations for fuel tanks for vehicles, as applicable. Examples of applicable standards and regulations are:

| <b>LPG tanks</b>                    |   |
|-------------------------------------|---|
| ECE Regulation No. 67<br>Revision 2 | Uniform provisions concerning:<br>I. Approval of specific equipment of vehicles of category M and N using liquefied petroleum gases in their propulsion system;<br>II. Approval of vehicles of category M and N fitted with specific equipment for the use of liquefied petroleum gases in their propulsion system with regard to the installation of such equipment                              |
| ECE Regulation No. 115              | Uniform provisions concerning the approval of:<br>I. Specific LPG (liquefied petroleum gases) retrofit systems to be installed in motor vehicles for the use of LPG in their propulsion systems;<br>II. Specific CNG (compressed natural gas) retrofit systems to be installed in motor vehicles for the use of CNG in their propulsion system  |
| <b>CNG tanks</b>                    |   |
| ECE Regulation No. 110              | Uniform provisions concerning the approval of:<br>I. Specific components of motor vehicles using compressed natural gas (CNG) and/or liquefied natural gas (LNG) in their propulsion system;<br>II. Vehicles with regard to the installation of specific components of an approved type for the use of compressed natural gas (CNG) and/or liquefied natural gas (LNG) in their propulsion system |



|  |  |
|--|--|
| ECE Regulation No. 115                   | (Uniform provisions concerning the approval of:<br>I. Specific LPG (liquefied petroleum gases) retrofit systems to be installed in motor vehicles for the use of LPG in their propulsion systems;<br>II. Specific CNG (compressed natural gas) retrofit systems to be installed in motor vehicles for the use of CNG in their propulsion system) |
| ISO 11439:2013                           | Gas cylinders – High pressure cylinders for the on-board storage of natural gas as a fuel for automotive vehicles  |
| ISO 15500-Series                         | ISO 15500: Road vehicles – Compressed natural gas (CNG) fuel system components – several parts as applicable   |
| ANSI NGV 2                               | Compressed natural gas vehicle fuel containers   |
| CSA B51 Part 2: 2014                     | Boiler, pressure vessel, and pressure piping code Part 2 Requirements for high-pressure cylinders for on board storage of fuels for automotive vehicles  |
| <b>Hydrogen pressure tanks</b>           |  |
| Global Technical Regulation (GTR) No. 13 | Global technical regulation on hydrogen and fuel cell vehicles (ECE/TRANS/180/Add.13)  |
| ISO/TS 15869:2009                        | Gaseous hydrogen and hydrogen blends – Land vehicle fuel tanks   |
| Regulation (EC) No.79/2009               | Regulation (EC) No. 79/2009 of the European Parliament and of the Council of 14 January 2009 on type approval of hydrogen-powered motor vehicles, and amending Directive 2007/46/EC  |
| Regulation (EU) No. 406/2010             | Commission Regulation (EU) No. 406/2010 of 26 April 2010 implementing Regulation (EC) No. 79/2009 of the European Parliament and of the Council on type-approval of hydrogen-powered motor vehicles.   |
| ECE Regulation No. 134                   | Uniform provisions concerning the approval of motor vehicles and their components with regards to the safety-related performance of hydrogen-fuelled vehicles (HFCV)   |
| CSA B51 Part 2: 2014                     | Boiler, pressure vessel, and pressure piping code Part 2 Requirements for high-pressure cylinders for on-board storage of fuels for automotive vehicles  |

Gas tanks designed and constructed in accordance with previous versions of relevant standards or regulations for gas tanks for motor vehicles, which were applicable at the time of the certification of the vehicles for which the gas tanks were designed and constructed may continue to be transported;

- .2 The fuel gas containment systems shall be leakproof and shall not exhibit any signs of external damage which may affect their safety;

**Note 1:** Criteria may be found in standard ISO 11623:2015 *Gas cylinders – Composite construction – Periodic inspection and testing* (or ISO 19078:2013 *Gas cylinders – Inspection of the cylinder installation, and requalification of high pressure cylinders for the on-board storage of natural gas as a fuel for automotive vehicles*).

**Note 2:** If the fuel gas containment systems are not leakproof or are overfilled or if they exhibit damage that could affect their safety (e.g. in case of a safety-related recall), they shall only be carried in salvage pressure receptacles in conformity with this Code.

- .3 If a fuel gas containment system is equipped with two valves or more integrated in line, the two valves shall be closed as to be gastight under normal conditions of transport. If only one valve exists or only one valve works, all openings with the exception of the opening of the pressure relief device shall be closed as to be gastight under normal conditions of transport;
- .4 Fuel gas containment systems shall be transported in such a way as to prevent obstruction of the pressure relief device or any damage to the valves and any other pressurised part of the fuel gas containment systems and unintentional release of the gas under normal conditions of



## Part 3 – Dangerous Goods List, special provisions and exceptions

- transport. The fuel gas containment system shall be secured in order to prevent slipping, rolling or vertical movement;
- .5 Valves shall be protected by one of the methods described in 4.1.6.1.8.1 to 4.1.6.1.8.5;
  - .6 Except for the case of fuel gas containment systems removed for disposal, recycling, repair, inspection or maintenance, they shall be filled with not more than 20% of their nominal filling ratio or nominal working pressure, as applicable;
  - .7 Notwithstanding the provisions of chapter 5.2, when fuel gas containment systems are consigned in a handling device, markings and labels may be affixed to the handling device; and
  - .8 Notwithstanding the provisions of 5.4.1.5, the information on the total quantity of dangerous goods may be replaced by the following information:
    - .1 the number of fuel gas containment systems; and
    - .2 in the case of liquefied gases the total net mass (kg) of gas of each fuel gas containment system and, in the case of compressed gases, the total water capacity (l) of each fuel gas containment system followed by the nominal working pressure.
- Examples for information in the transport document:
- Example 1: “UN 1971 natural gas, compressed, 2.1, 1 fuel gas containment system of 50 l in total, 200 bar”.
- Example 2: “UN 1965 hydrocarbon gas mixture, liquefied, n.o.s., 2.1, 3 fuel gas containment systems, each of 15 kg net mass of gas”.
- 393 The nitrocellulose shall meet the criteria of the Bergmann-Junk test or methyl violet paper test in the *Manual of Tests and Criteria* Appendix 10. Tests of type 3 (c) need not be applied.
- 394 The nitrocellulose shall meet the criteria of the Bergmann-Junk test or methyl violet paper test in the *Manual of Tests and Criteria* Appendix 10.
- 395 This entry shall only be used for solid medical waste of category A transported for disposal.
- △ 396 Large and robust articles may be transported with connected gas cylinders with the valves open regardless of 4.1.6.1.5 provided:
- .1 the gas cylinders contain nitrogen of UN 1066 or compressed gas of UN 1956 or compressed air of UN 1002;
  - .2 the gas cylinders are connected with the article through pressure regulators and fixed piping in such a way that the pressure of the gas (gauge pressure) in the article does not exceed 35 kPa (0.35 bar);
  - .3 the gas cylinders are properly secured so that they cannot move in relation to the article and are fitted with strong and pressure resistant hoses and pipes;
  - .4 the gas cylinders, pressure regulators, piping and other components are protected from damage and impacts during transport by wooden crates or other suitable means;
  - .5 the transport document includes the following statement: “Transport in accordance with special provision 396.”; and
  - .6 cargo transport units containing articles transported with cylinders with open valves containing a gas presenting a risk of asphyxiation are well ventilated and marked in accordance with 5.5.3.6.
- 397 Mixtures of nitrogen and oxygen containing not less than 19.5% and not more than 23.5% oxygen by volume may be transported under this entry when no other oxidizing gases are present. A division 5.1 subsidiary hazard label is not required for any concentrations within this limit.
- 398 This entry applies to mixtures of butylenes, 1-butylene, *cis*-2-butylene and *trans*-2-butylene. For isobutylene, see UN 1055.
- 399 For articles that meet the definition for DETONATORS, ELECTRONIC as described in appendix B and assigned to UN Nos. 0511, 0512 and 0513, the entries for DETONATORS, ELECTRIC (UN Nos. 0030, 0255 and 0456) may continue to be used until 30 June 2025.
- 400 Sodium ion cells and batteries and sodium ion cells and batteries contained in or packed with equipment, prepared and offered for transport, are not subject to other provisions of this Code if they meet the following:
- .1 The cell or battery is short-circuited, in a way that the cell or battery does not contain electrical energy. The short-circuiting of the cell or battery shall be easily verifiable (e.g. busbar between terminals).
  - .2 Each cell or battery meets the provisions of 2.9.5.1, 2.9.5.2, 2.9.5.4, 2.9.5.5 and 2.9.5.6.
  - .3 Each package shall be marked according to 5.2.1.9.
  - .4 Except when cells or batteries are installed in equipment, each package shall be capable of withstanding a 1.2 m drop test in any orientation without damage to cells or batteries contained therein, without shifting of the contents so as to allow battery to battery (or cell to cell) contact and without release of contents.

## Chapter 3.3 – Special provisions applicable to certain substances, materials or articles

3

- .5 Cells and batteries, when installed in equipment shall be protected from damage. When batteries are installed in equipment, the equipment shall be packed in strong outer packagings constructed of suitable material of adequate strength and design in relation to the packaging's capacity and its intended use unless the battery is afforded equivalent protection by the equipment in which it is contained.
- .6 Each cell, including when it is a component of a battery, shall only contain dangerous goods that are authorized to be transported in accordance with the provisions of chapter 3.4 and in a quantity not exceeding the quantity specified in column 7a of the Dangerous Goods List of chapter 3.2.
- 401 Sodium ion cells and batteries with organic electrolyte shall be transported as UN 3551 or 3552, as appropriate. Sodium ion cells and batteries with aqueous alkali electrolyte shall be transported as UN 2795 BATTERIES, WET, FILLED WITH ALKALI, electric storage.
- 402 Substances transported under this entry shall have a vapour pressure at 70°C not exceeding 1.1 MPa (11 bar) and a density at 50°C not lower than 0.525 kg/L.
- 403 Nitrocellulose (NC) membrane filters covered by this entry with NC content not exceeding 53 g/m<sup>2</sup> and an NC net mass not exceeding 300 g per inner packaging, are not subject to these requirements if they meet the following conditions:
- .1 They are packed with paper separators of minimum 80 g/m<sup>2</sup> placed between each layer of NC membrane filters.
  - .2 They are packed to maintain the alignment of the NC membrane filters and the paper separators in any of the following configurations:
    - .1 Rolls tightly wound and packed in plastic foil of minimum 80 g/m<sup>2</sup> or aluminium pouches with an oxygen permeability of equal or less than 0.1% according to standard ISO 15105-1:2007.
    - .2 Sheets packed in cardboard of minimum 250 g/m<sup>2</sup> or aluminium pouches with an oxygen permeability of equal or less than 0.1% according to standard ISO 15105-1:2007.
    - .3 Round filters packed in disc holders or cardboard packaging of minimum 250 g/m<sup>2</sup> or single packed in pouches of paper and plastic material of total minimum 100 g/m<sup>2</sup>.
- 404 Vehicles powered by sodium ion batteries, containing no other dangerous goods, are not subject to other provisions of this Code, if the battery is short-circuited in a way that the battery does not contain electrical energy. The short-circuiting of the battery shall be easily verifiable (e.g. busbar between terminals).
- 405 Vehicles are not subject to the marking or labelling requirements of chapter 5.2 when they are not fully enclosed by packagings, crates or other means that prevent ready identification.
- 406 This entry may be transported in accordance with the limited quantity provisions of chapter 3.4 when transported in pressure receptacles containing not more than 1,000 mL. The pressure receptacles shall meet the requirements of packing instruction P200 of 4.1.4.1 and have a test pressure capacity product not exceeding 15.2 MPa L (152 bar L). The pressure receptacles shall not be packed together with other dangerous goods.
- 407 Fire suppressant dispersing devices are articles which contain a pyrotechnic substance, which are intended to disperse a fire-extinguishing agent (or aerosol) when activated, and which do not contain any other dangerous goods. These articles, as packaged for transport, shall fulfil the criteria for division 1.4S, when tested in accordance with test series 6(c) of section 16 of part I of the *Manual of Tests and Criteria*. The device shall be transported with either the means of activation removed or equipped with at least two independent means to prevent accidental activation.
- Fire suppressant dispersing devices shall only be assigned to class 9, UN 3559 if the following additional conditions are met:
- .1 The device meets the exclusion criteria in 2.1.3.4.2.2, 2.1.3.4.2.3 and 2.1.3.4.2.4.
  - .2 The suppressant shall be deemed safe for normally occupied spaces in compliance with international or regional standards (e.g. NFPA 2010).
  - .3 The article shall be packaged in a manner such that when activated, temperatures of the outside of the package shall not exceed 200°C.
  - .4 This entry shall be used only with the approval of the competent authority of the country of manufacture.
- This entry does not apply to "SAFETY DEVICES, electrically initiated" described in special provision 280 (UN 3268).
- 408 This entry applies only to aqueous solutions comprised of water, tetramethylammonium hydroxide (TMAH), and no more than 1% of other constituents. Other formulations containing

## Part 3 – Dangerous Goods List, special provisions and exceptions

- 3
- tetramethylammonium hydroxide must be assigned to an appropriate generic or N.O.S. entry (e.g. UN 2927, TOXIC LIQUID, CORROSIVE, ORGANIC, N.O.S., etc.), except as follows:
- .1 other formulations containing a surfactant in a concentration > 1% and with not less than 8.75% tetramethylammonium hydroxide must be assigned to UN 2927, TOXIC LIQUID, CORROSIVE, ORGANIC, N.O.S., PG I; and
  - .2 other formulations containing a surfactant in a concentration > 1% and with more than 2.38% but less than 8.75% tetramethylammonium hydroxide must be assigned to UN 2927, TOXIC LIQUID, CORROSIVE, ORGANIC, N.O.S., PG II.
- 409 The provisions of chapter 3.2 from the IMDG Code Amendment 41-22 may continue to be applied until 31 December 2026.
- 900 The transport of the following substances is prohibited:
- AMMONIUM HYPOCHLORITE
  - AMMONIUM NITRATE liable to self-heating sufficient to initiate decomposition
  - AMMONIUM NITRITES and mixtures of an inorganic nitrite with an ammonium salt
  - CHLORIC ACID, AQUEOUS SOLUTION with more than 10% chloric acid
  - ETHYL NITRITE pure
  - HYDROCYANIC ACID, AQUEOUS SOLUTION (HYDROGEN CYANIDE, AQUEOUS SOLUTION) with more than 20% hydrogen cyanide
  - HYDROGEN CHLORIDE, REFRIGERATED LIQUID
  - HYDROGEN CYANIDE SOLUTION, IN ALCOHOL with more than 45% hydrogen cyanide
  - MERCURY OXYCYANIDE pure
  - METHYL NITRITE
  - PERCHLORIC ACID with more than 72% acid, by mass
  - SILVER PICRATE, dry or wetted with less than 30% water by mass
  - ZINC AMMONIUM NITRITE
- See also special provisions 349, 350, 351, 352 and 353.
- 903 HYPOCHLORITE MIXTURES with 10% or less available CHLORINE are not subject to the provisions of this Code.
- 904 The provisions of this Code, except for the marine pollution aspects, do not apply to these substances if they are completely miscible with water, except when transported in receptacles with a capacity greater than 250 L and in tanks.
- 905 May only be shipped as an 80% solution in TOLUENE. The pure product is shock-sensitive and decomposes with explosive violence and the possibility of detonation when heated under confinement. Can be ignited by impact.
- 907 The consignment shall be accompanied by a certificate from a recognized authority stating:
- moisture content;
  - fat content;
  - details of anti-oxidant treatment for meals older than 6 months (for UN 2216 only);
  - anti-oxidant concentration at the time of shipment, see special provision 308 (for UN 2216 only);
  - packing, number of bags and total mass of the consignment;
  - temperature of fish meal at the time of despatch from the factory;
  - date of production.
- No weathering/curing is required prior to loading. Fish meal under UN 1374 shall have been weathered for not less than 28 days before shipment.
- When fish meal is packed into containers, the containers shall be packed in such a way that the free air space has been restricted to the minimum.
- 912 This entry also covers solutions in water with concentrations above 70%.
- 916 The provisions of this Code do not apply to this substance when:
- mechanically produced, with a particle size of 53 microns or greater; or
  - chemically produced, with a particle size of 840 microns or greater.
- 917 Scrap with rubber content below 45% or exceeding 840 microns and fully vulcanized hard rubber are not subject to the provisions of this Code.
- 920 Bars, ingots or sticks are not subject to the provisions of this Code.
- 921 Zirconium, dry, 254 microns or thicker is not subject to the provisions of this Code.

## Chapter 3.3 – Special provisions applicable to certain substances, materials or articles

3

- △ 922 With the exception of the documentation requirements in 5.4.4.2, the provisions of this Code do not apply to LEAD PHOSPHITE, DIBASIC which is accompanied by a certificate from the shipper stating that the substance, as offered for shipment, has been stabilized in such a way that it does not possess properties of class 4.1.
- 923 The temperature shall be checked regularly.
- ⊗
- 926 This substance shall preferably have been weathered for not less than one month before shipment unless a certificate from a person recognized by the competent authority of the country of shipment states a maximum moisture content of 5%.
- 927 *p*-Nitrosodimethylaniline, wetted with more than 50% water is not subject to the provisions of this Code.
- △ 928 The provisions of this Code do not apply:
- to fish meal when acidified and wetted with more than 40% water, by mass, irrespective of other factors;
  - to fish meal manufactured from “white” fish with a moisture content of not more than 12% and a fat content of not more than 5% by mass; or
  - with the exception of the documentation requirements in 5.4.4.2, to consignments of fish meal which are accompanied by a certificate issued by the competent authority of the country of shipment or other recognized authority stating that the product has no self-heating properties when transported in packaged form.
- 929 If satisfied, as a result of tests, that such relaxation is justified, the competent authority may permit:
- the seed cakes described as “SEED CAKE, containing vegetable oil (a) mechanically expelled seeds, containing more than 10% of oil or more than 20% of oil and moisture combined” to be transported under conditions governing “SEED CAKE, containing vegetable oil (b) solvent extractions and expelled seeds, containing not more than 10% of oil and, when the amount of moisture is higher than 10% not more than 20% of oil and moisture combined”, and
  - the seed cakes described as “SEED CAKE, containing vegetable oil (b) solvent extractions and expelled seeds, containing not more than 10% of oil and, when the amount of moisture is higher than 10% not more than 20% of oil and moisture combined” to be transported under conditions governing SEED CAKE, UN 2217.
- Certificates from the shipper shall state oil content and moisture content and shall accompany the shipment.
- 930 All pesticides can only be carried under the provisions of this class if accompanied by a certificate supplied by the shipper stating that, when in contact with water, it is not combustible and does not show tendency to autoignition, and that the mixture of gases evolved is not flammable. Otherwise, the provisions of class 4.3 shall be applicable.
- △ 931 With the exception of the documentation requirements in 5.4.4.2, the provisions of this Code do not apply to a consignment of this substance which is accompanied by a certificate from the shipper stating that it has no self-heating properties.
- 932 Requires a certificate from the maker or shipper, stating that the shipment was stored under cover, but in the open air, in the size in which it was packaged, for not less than 3 days prior to shipment.
- 934 Requires the percentage range of calcium carbide impurity to be shown on the shipping documents.
- △ 935 With the exception of the documentation requirements in 5.4.4.2, the provisions of this Code do not apply to substances which do not evolve flammable gases when wet which are accompanied by a certificate from the shipper, stating that the substance as offered for shipment does not evolve flammable gases when wet.
- 937 The solid hydrated form of this substance is not subject to the provisions of this Code.
- △ 939 With the exception of the documentation requirements in 5.4.4.2, the provisions of this Code do not apply to a consignment of this substance that is accompanied by a shipper’s certificate stating that it does not contain more than 0.05% maleic anhydride.
- 942 The concentration and temperature of the solution at the time of loading, its percentage of combustible material and of chlorides as well as the contents of free acid shall be certified.
- 943 Water-activated articles shall bear a subsidiary hazard label of class 4.3.
- 946 Requires certification from the shipper that the substance is not of class 4.2.
- 948 These substances may be transported in bulk in cargo transport units only if their melting point is 75°C or above.
- 952 UN 1942 may be transported in bulk container if approved by the competent authority.

## Part 3 – Dangerous Goods List, special provisions and exceptions

- 3
- △ 954 With the exception of the documentation requirements in 5.4.4.2, the provisions of this Code do not apply to baled hay with a moisture content of less than 14% shipped in closed cargo transport units and accompanied by a certificate from the shipper stating that the product does not present any class 4.1 UN 1327 hazard in transport and that its moisture content is less than 14%.
- 955 If a viscous substance and its packaging fulfils the provisions of 2.3.2.5, the packing provisions of chapter 4.1, the marking and labelling provisions of chapter 5.2 and the package testing provisions of chapter 6.1 are not applicable.
- 958 This entry also covers articles, such as rags, cotton waste, clothing or sawdust, containing polychlorinated biphenyls, polyhalogenated biphenyls or polyhalogenated terphenyls where no free visible liquid is present.
- 959 Waste aerosols or waste gas cartridges authorized for transport under special provision 327 shall only be transported on short international voyages. Long international voyages are authorized only with the approval of the competent authority. Packagings shall be marked and labelled and cargo transport units shall be marked and placarded for appropriate sub-division of class 2 and, if applicable, the subsidiary hazard(s).
- 960 Not subject to the provisions of this Code but may be subject to provisions governing the transport of dangerous goods by other modes.
- △ 961 Vehicles are not subject to the provisions of this Code, other than those in P912, SP388 and SP977 when applicable, if any of the following conditions are met:
- .1 vehicles are stowed on the vehicle, special category and ro-ro spaces or on the weather deck of a ro-ro ship or a cargo space designated by the Administration (flag State) in accordance with SOLAS 74, chapter II-2, regulation 20 as specifically designed and approved for the carriage of vehicles, and there are no signs of leakage from the battery, engine, fuel cell, compressed gas cylinder or accumulator, or fuel tank when applicable. When packed in a cargo transport unit the exception does not apply to container cargo spaces of a ro-ro ship.
  - .2 vehicles powered by a flammable liquid fuel with a flashpoint of 38°C or above, there are no leaks in any portion of the fuel system, the fuel tank(s) contains 450 L of fuel or less and installed batteries are protected from short-circuit;
  - .3 vehicles powered by a flammable liquid fuel with a flashpoint less than 38°C, the fuel tank(s) are empty and installed batteries are protected from short circuit. Vehicles are considered to be empty of flammable liquid fuel when the fuel tank has been drained and the vehicles cannot be operated due to a lack of fuel. Engine components such as fuel lines, fuel filters and injectors do not need to be cleaned, drained or purged to be considered empty. The fuel tank does not need to be cleaned or purged;
  - .4 vehicles powered by a flammable gas (liquefied or compressed), the fuel tank(s) are empty and the positive pressure in the tank does not exceed 2 bar, the fuel shut-off or isolation valve is closed and secured, and installed batteries are protected from short circuit;
  - .5 vehicles solely powered by a wet or dry electric storage battery or a sodium battery, and the battery is protected from short circuit.
  - .6 vehicles solely powered by a sodium ion battery, and the battery is short-circuited in a way that the battery does not contain electrical energy. The short circuiting shall be easily identifiable (e.g. busbar between terminals).
- △ 962 Vehicles, not meeting the conditions of special provision 961 shall be assigned to class 9 and shall meet the following requirements:
- .1 vehicles shall not show signs of leakage from batteries, engines, fuel cells, compressed gas cylinders or accumulators, or fuel tank(s) when applicable;
  - .2 for flammable liquid powered vehicles the fuel tank(s) containing the flammable liquid shall not be more than one fourth full and in any case the flammable liquid shall not exceed 250 L unless otherwise approved by the competent authority;
  - .3 for flammable gas powered vehicles, the fuel shut-off valve of the fuel tank(s) shall be securely closed;
  - △ .4 installed batteries shall meet the provisions of SP388 or SP977, as applicable, and be protected from damage, short circuit, and accidental activation during transport.
  - △ The provisions of this Code relevant to marking, labelling, placarding and marine pollutants shall only apply to vehicles that are fully enclosed by packagings, crates or other means that prevent ready identification (e.g., overpack).
- 963 Nickel-metal hydride cells or batteries packed with or contained in equipment and nickel-metal hydride button cells are not subject to the provisions of this Code.
- All other nickel-metal hydride cells or batteries shall be securely packed and protected from short circuit. They are not subject to other provisions of this Code provided that they are loaded in a cargo



## Chapter 3.3 – Special provisions applicable to certain substances, materials or articles

3

- transport unit in a total quantity of less than 100 kg gross mass. When loaded in a cargo transport unit in a total quantity of 100 kg gross mass or more, they are not subject to other provisions of this Code except those of 5.4.1, 5.4.3 and columns 16a and 16b of the Dangerous Goods List in chapter 3.2.
- △ 964 With the exception of the documentation requirements in 5.4.4.2, the provisions of this Code do not apply to this substance when:
- .1 it is transported in non-friable prills or granules form;
  - .2 it does not meet the criteria for class 5.1 based on the result of one of the tests for oxidizing solid substances as reflected in the UN Manual of Tests and Criteria (see 34.4.1 or 34.4.3); and
  - .3 it is accompanied by a certificate issued by a laboratory recognized by the competent authority stating the results of the test.
- 965 .1 When transported in cargo transport units, the cargo transport units shall provide an adequate exchange of air in the unit (e.g. by using a ventilated container, open-top container or container in one door off operation) to prevent the build-up of an explosive atmosphere. Alternatively, these entries shall be transported under temperature control in refrigerated cargo transport units that comply with the provisions of 7.3.7.6. When cargo transport units with venting devices are used, these devices shall be kept clear and operable. When mechanical devices are used for ventilation, they shall be explosion-proof to prevent ignition of flammable vapours from the substances.
- .2 The provisions of .1 do not apply if:
    - .1 the substance is packed in hermetically sealed packagings or IBCs, which conform to packing group II performance level for liquid dangerous goods according to the provisions of 6.1 or 6.5, respectively; and
    - .2 the marked hydraulic test pressure exceeds 1.5 times the total gauge pressure in the packagings or IBCs determined at 55°C for the respective filling goods according to 4.1.1.10.1.
  - .3 Where the substance is loaded in closed cargo transport units, the provisions of 7.3.6.1 shall be met.
  - .4 Cargo transport units shall be marked with a warning mark including the words “CAUTION – MAY CONTAIN FLAMMABLE VAPOUR” with lettering not less than 25 mm high. This mark shall be affixed at each access point in a location where it will be easily seen by persons prior to opening or entering the cargo transport unit and shall remain on the cargo transport unit until the following provisions are met:
    - .1 the cargo transport unit has been completely ventilated to remove any hazardous concentration of vapour or gas;
    - .2 the immediate vicinity of the cargo transport unit is clear of any source of ignition; and
    - .3 the goods have been unloaded.
- 966 Sheeted bulk containers (BK1) are only permitted in accordance with 4.3.3.
- 967 Flexible bulk containers (BK3) are only permitted in accordance with 4.3.4.
- 968 This entry shall not be used for sea transport. Discarded packaging shall meet the requirements of 4.1.1.11.
- 969 Substances classified in accordance to 2.9.3 are subject to the provisions for marine pollutants. Substances which are transported under UN 3077 and UN 3082 but which do not meet the criteria of 2.9.3 (see 2.9.2.2) are not subject to the provisions for marine pollutants. However for substances that are identified as marine pollutants in this Code (see Index) but which no longer meet the criteria of 2.9.3, the provisions of 2.10.2.6 apply.
- 971 Battery powered equipment may only be transported provided that the battery shows no sign of leakage and is protected from short-circuit. In this case, no other provisions of this Code apply.
- △ 972 Lithium batteries shall meet the provisions of 2.9.4, except that 2.9.4.1, 2.9.4.5.7, 2.9.4.6.3 if applicable, 2.9.4.6.4 if applicable and 2.9.4.7 do not apply when batteries of a production run of not more than 100 cells or batteries, or pre-production prototypes of cells or batteries when these prototypes are transported for testing, are installed in machinery or engines. Where a lithium battery installed in an engine or machinery is damaged or defective, the battery shall be removed.
- 973 Packages, with the exception of bales, shall also display the proper shipping name and the UN number of the substance that they contain in accordance with 5.2.1. In any case, the packages, including bales, are exempt from class marking provided that they are loaded in a cargo transport unit and that they contain goods to which only one UN number has been assigned. The cargo transport units in which the packages, including bales, are loaded shall display any relevant labels, placards and marks in accordance with chapter 5.3.
- 974 These substances may be transported in IMO type 9 tanks.



## Part 3 – Dangerous Goods List, special provisions and exceptions

- 3
- 975 MEDICAL WASTE, CATEGORY A, AFFECTING HUMANS, solid or MEDICAL WASTE, CATEGORY A, AFFECTING ANIMALS only, solid shall only be transported on short international voyages. Long international voyages are authorized only with the approval of the competent authorities of the port State of departure, port State of arrival and flag State.
- 976 The transport of this substance shall be prohibited except with the approval of the competent authorities of the port State of departure, port State of arrival and flag State.
- 977 Sodium ion batteries shall meet the provisions of 2.9.5.
- 978
- .1 For the purpose of this Code, carbon of animal or vegetable origin means carbon, generated in a production or manufacturing process, not formed in a geological process and not obtained from mining. Carbon covered by this entry is produced by pyrolysis of an organic material such as bone, bamboo, coconut shell, jute or wood.
  - .2 The UN N.4 test according to section 33.4.6 of the UN *Manual of Tests and Criteria* shall not be used to exempt carbon of animal or vegetable origin (UN 1361) from the provisions of this Code.
  - .3 Without testing, the material shall be assigned to at least packing group III.
  - .4 Unless otherwise approved by the competent authority, the following provisions apply:
    - .1 after production, the unpacked material shall be subject to weathering (stored under cover, but in the open air) for a minimum period of 14 days before being packaged for transport; or
    - .2 after pyrolysis, steam and cooling shall be applied to the unpacked material and the material shall be packed under an inert gas atmosphere (e.g. nitrogen); packages shall then be stored under loose cover or in the open air for a minimum of 24 hours before transport.
  - .5 The material shall be packed into packagings only when the temperature of the material does not exceed 40°C on the day of packing.
  - .6 When stowed in a cargo transport unit, minimum headspace in the CTU of 30 cm shall be maintained, and:
    - .1 the stowage height of the package(s) in the unit should not exceed 1.5 m; or
    - .2 the maximum block size of the packages should be 16 m<sup>3</sup> and a minimum of 15 cm of space between blocks should be maintained.
- 979 With the exception of the documentation requirements in 5.4.4.2, the provisions of this Code do not apply to this substance when:
- .1 it is accompanied by a certificate from the shipper stating that the substance is steam activated carbon; or
  - .2 it is chemically activated carbon, which is accompanied by a certificate issued by a laboratory recognized by the competent authority, stating that the substance does not meet the criteria for class 4.2 based on a negative test result for self-heating substances when tested in accordance with the UN *Manual of Tests and Criteria* (see 33.4.6).

## Chapter 3.4

### *Dangerous goods packed in limited quantities*

#### 3.4.1 General

3.4.1.1 This chapter provides the provisions applicable to the transport of dangerous goods of certain classes packed in limited quantities. The applicable quantity limit for the inner packaging or article is specified for each substance in column 7a of the Dangerous Goods List of chapter 3.2. In addition, the quantity "0" has been indicated in this column for each entry not permitted to be transported in accordance with this chapter.

3.4.1.2 Limited quantities of dangerous goods packed in such limited quantities, meeting the provisions of this chapter, are not subject to any other provisions of this Code except the relevant provisions of:

- .1 Part 1, chapters 1.1, 1.2 and 1.3;
- .2 Part 2;
- .3 Part 3, chapters 3.1, 3.2, 3.3;
- .4 Part 4, 4.1.1.1, 4.1.1.2 and 4.1.1.4 to 4.1.1.8;
- .5 Part 5, 5.1.1 except 5.1.1.6, 5.1.2.3, 5.2.1.7, 5.2.1.9, 5.3.2.4, and chapter 5.4;
- .6 Part 6, construction requirements of 6.1.4, 6.2.1.2 and 6.2.4;
- .7 Part 7, 7.1.3.2, 7.6.3.1 and 7.3 except 7.3.3.15 and 7.3.4.1.

#### 3.4.2 Packing

3.4.2.1 Dangerous goods shall be packed only in inner packagings placed in suitable outer packagings. Intermediate packagings may be used. In addition, for articles of division 1.4, compatibility group S, the provisions of section 4.1.5 shall be fully complied with. The use of inner packagings is not necessary for the transport of articles such as aerosols or "receptacles, small, containing gas". The total gross mass of the package shall not exceed 30 kg.

3.4.2.2 Except for articles of division 1.4, compatibility group S, shrink-wrapped or stretch-wrapped trays meeting the conditions of 4.1.1.1, 4.1.1.2 and 4.1.1.4 to 4.1.1.8 are acceptable as outer packagings for articles or inner packagings containing dangerous goods transported in accordance with this chapter. Inner packagings that are liable to break or be easily punctured, such as those made of glass, porcelain, stoneware or certain plastics, shall be placed in suitable intermediate packagings meeting the provisions of 4.1.1.1, 4.1.1.2 and 4.1.1.4 to 4.1.1.8, and be so designed that they meet the construction requirements of 6.1.4. The total gross mass of the package shall not exceed 20 kg.

3.4.2.3 Liquid goods of class 8, packing group II in glass, porcelain or stoneware inner packagings shall be enclosed in a compatible and rigid intermediate packaging.

#### 3.4.3 Stowage

Dangerous goods packed in limited quantity are allocated stowage category A as defined in 7.1.3.2. The other stowage provisions indicated in column 16a of the Dangerous Goods List are not applicable.

#### 3.4.4 Segregation

3.4.4.1 Different dangerous substances in limited quantities may be packed in the same outer packaging, provided:

- .1 the substances comply with the provisions of 7.2.6.1; and
- .2 the segregation provisions of chapter 7.2, including the segregation provisions in column 16b of the Dangerous Goods List, are taken into account. However, notwithstanding the individual provisions specified in the Dangerous Goods List, substances in packing group III within the same class may be packed together subject to compliance with 3.4.4.1.1 of the IMDG Code. The following statement shall be included in the transport document: "Transport in accordance with 3.4.4.1.2 of the IMDG Code" (see 5.4.1.5.2.2).

**Part 3 – Dangerous Goods List, special provisions and exceptions**

- 3.4.4.2 The segregation provisions of chapter 7.2 to 7.7 including the segregation provisions in column 16b of the Dangerous Goods List are not applicable for packagings containing dangerous goods in limited quantities or in relation to other dangerous goods. However, articles of division 1.4, compatibility group S shall not be stowed in the same compartment or hold, or cargo transport unit with dangerous goods of class 1 of compatibility groups A and L.

**3.4.5 Marking and placarding**

- 3.4.5.1 Except for air transport, packages containing dangerous goods in limited quantities shall bear the mark shown below:

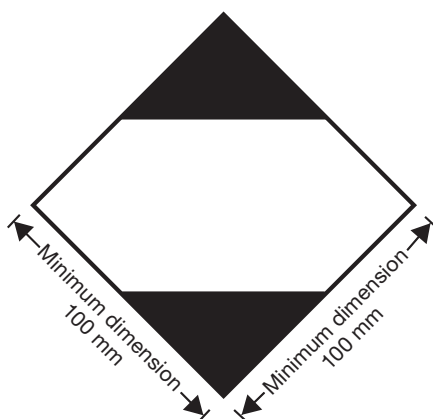

**Mark for packages containing limited quantities**

The mark shall be readily visible, legible and able to withstand open weather exposure without a substantial reduction in effectiveness. The mark shall be in the form of a square set at an angle of 45° (diamond-shaped). The top and bottom portions and the surrounding line shall be black. The centre area shall be white or a suitable contrasting background. The minimum dimensions shall be 100 mm × 100 mm and the minimum width of the line forming the diamond shall be 2 mm. Where dimensions are not specified, all features shall be in approximate proportion to those shown. If the size of the package so requires, the minimum outer dimensions shown above may be reduced to be not less than 50 mm × 50 mm provided the mark remains clearly visible. The minimum width of the line forming the diamond may be reduced to a minimum of 1 mm.

- 3.4.5.2 Packages containing dangerous goods packed in conformity with the provisions of part 3, chapter 4 of the ICAO *Technical Instructions for the Safe Transport of Dangerous Goods by Air* may bear the mark shown below to certify conformity with these provisions:

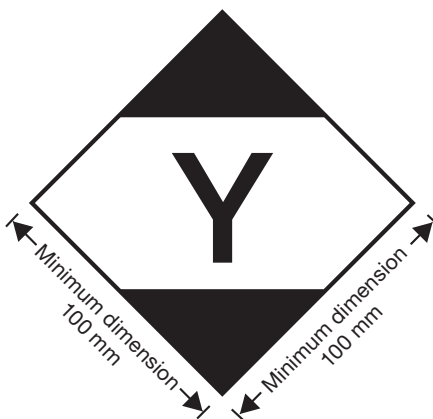

**Mark for packages containing limited quantities conforming to part 3, chapter 4 of the ICAO *Technical Instructions for the Safe Transport of Dangerous Goods by Air***

The mark shall be readily visible, legible and able to withstand open weather exposure without a substantial reduction in effectiveness. The mark shall be in the form of a square set at an angle of 45° (diamond-shaped). The top and bottom portions and the surrounding line shall be black. The centre area shall be white or a suitable contrasting background. The minimum dimensions shall be 100 mm × 100 mm and the minimum width of the line forming the diamond shall be 2 mm. The symbol “Y” shall be placed in the centre of the mark and shall be clearly visible. Where dimensions are not specified, all features shall be in approximate proportion to those shown. If the size of the package so requires, the minimum outer dimensions shown

above may be reduced to be not less than 50 mm × 50 mm provided the mark remains clearly visible. The minimum width of the line forming the diamond may be reduced to a minimum of 1 mm. The symbol “Y” shall remain in approximate proportion to that shown above.

#### 3.4.5.3 Multimodal recognition of marks

3.4.5.3.1 Packages containing dangerous goods bearing the mark shown in 3.4.5.2 with or without the additional labels and marks for air transport shall be deemed to meet the provisions of section 3.4.2 and need not bear the mark shown in 3.4.5.1.

3.4.5.3.2 Packages containing dangerous goods in limited quantities bearing the mark shown in 3.4.5.1 and conforming with the provisions of the ICAO *Technical Instructions for the Safe Transport of Dangerous Goods by Air*, including all necessary marks and labels specified in parts 5 and 6, shall be deemed to meet the provisions of section 3.4.1 as appropriate and of section 3.4.2.

3.4.5.4 When packages containing dangerous goods packed in limited quantities are placed in an overpack or in a unit load, the overpack or the unit load shall be marked with the mark required by this chapter unless the marks representative of all dangerous goods in the overpack or the unit load are visible. In addition, an overpack shall be marked with the word “OVERPACK” unless marks representative of all dangerous goods, as required by this chapter, in the overpack are visible. The lettering of the “OVERPACK” mark shall be at least 12 mm high. The other provisions of 5.1.2.1 apply only if other dangerous goods which are not packed in limited quantities are contained in the overpack or in a unit load and only in relation to these other dangerous goods.

#### 3.4.5.5 Placarding and marking of cargo transport units

3.4.5.5.1 Cargo transport units containing dangerous goods packed in limited quantities with no other dangerous goods shall not be placarded nor marked according to 5.3.2.0 and 5.3.2.1. However, they shall be suitably marked on the exterior with the mark in 3.4.5.5.4.

3.4.5.5.2 Cargo transport units containing dangerous goods and dangerous goods packed in limited quantities shall be placarded and marked according to the provisions applicable to the dangerous goods which are not packed in limited quantities. However, if no placard or mark is required for the dangerous goods not packed in limited quantities, the cargo transport units shall be marked with the mark in 3.4.5.5.4.

3.4.5.5.3 [Reserved]

3.4.5.5.4 When required in 3.4.5.5.1 or 3.4.5.5.2, the following mark shall be affixed on cargo transport units:

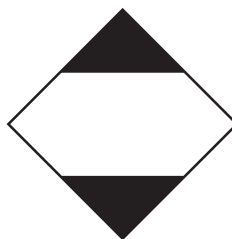

The mark shall be readily visible, legible and be such that this information will still be identifiable on cargo transport units surviving at least three months' immersion in the sea. In considering suitable marking methods, account shall be taken of ease with which the surface of the cargo transport unit can be marked. The top and bottom portions and the surrounding line shall be black. The centre area shall be white or a suitable contrasting background. The minimum dimensions shall be of 250 mm × 250 mm in locations indicated in 5.3.1.1.4.1.

### 3.4.6 Documentation

3.4.6.1 In addition to the provisions for documentation specified in chapter 5.4, the words “limited quantity” or “LTD QTY” shall be included on the dangerous goods transport document together with the description of the shipment.

## Chapter 3.5

### *Dangerous goods packed in excepted quantities*

#### 3.5.1 Excepted quantities

3.5.1.1 Excepted quantities of dangerous goods of certain classes, other than articles, meeting the provisions of this chapter, are not subject to any other provisions of this Code except for:

- .1 The training provisions in chapter 1.3;
- .2 The classification procedures and packing group criteria in Part 2, Classification;
- .3 The packaging provisions of 4.1.1.1, 4.1.1.2, 4.1.1.4, 4.1.1.4.1 and 4.1.1.6 in Part 4; and
- .4 The provisions for documentation specified in chapter 5.4.

**Note:** In the case of radioactive material, the provisions for radioactive material in excepted packages in 1.5.1.5 apply.

3.5.1.2 Dangerous goods which may be carried as excepted quantities in accordance with the provisions of this chapter are shown in column 7b of the Dangerous Goods List by means of an alphanumeric code as follows:

| Code | Maximum net quantity per inner packaging<br>(in grams for solids and mL<br>for liquids and gases) | Maximum net quantity per outer packaging<br>(in grams for solids and mL for liquids<br>and gases, or sum of grams and mL<br>in the case of mixed packaging) |
|------|---|---|
| E0   | Not permitted as excepted quantity  |   |
| E1   | 30  | 1,000   |
| E2   | 30  | 500   |
| E3   | 30  | 300   |
| E4   | 1   | 500   |
| E5   | 1   | 300   |

For gases, the volume indicated for inner packagings refers to the water capacity of the inner receptacle and the volume indicated for outer packagings refers to the combined water capacity of all inner packagings within a single outer packaging.

3.5.1.3 Where dangerous goods in excepted quantities for which different codes are assigned are packaged together, the total quantity per outer packaging shall be limited to that corresponding to the most restrictive code.

3.5.1.4 Excepted quantities of dangerous goods assigned to codes E1, E2, E4 and E5 are not subject to the provisions of this Code provided that:

- .1 The maximum net quantity of material per inner packaging is limited to 1 mL for liquids and gases and 1 g for solids;
- .2 The provisions of 3.5.2 are met, except that an intermediate packaging is not required if the inner packagings are securely packed in an outer packaging with cushioning material in such a way that, under normal conditions of transport, they cannot break, be punctured, or leak their contents; and for liquid dangerous goods, the outer packaging contains sufficient absorbent material to absorb the entire contents of the inner packagings;
- .3 The provisions of 3.5.3 are complied with; and
- .4 The maximum net quantity of dangerous goods per outer packaging does not exceed 100 g for solids or 100 mL for liquids and gases.

## 3.5.2 Packagings

3.5.2.1 Packagings used for the transport of dangerous goods in excepted quantities shall be in compliance with the following:

- .1 There shall be an inner packaging and each inner packaging shall be constructed of plastic (when used for liquid dangerous goods it shall have a thickness of not less than 0.2 mm), or of glass, porcelain, stoneware, earthenware or metal (see also 4.1.1.2) and the closure of each inner packaging shall be held securely in place with wire, tape or other positive means; any receptacle having a neck with moulded screw threads shall have a leakproof threaded-type cap. The closure shall be resistant to the contents;
- .2 Each inner packaging shall be securely packed in an intermediate packaging with cushioning material in such a way that, under normal conditions of transport, they cannot break, be punctured or leak their contents. For liquid dangerous goods, the intermediate or outer packaging shall contain sufficient absorbent material to absorb the entire contents of the inner packagings. When placed in the intermediate packaging, the absorbent material may be the cushioning material. Dangerous goods shall not react dangerously with cushioning, absorbent material and packaging material or reduce the integrity or function of the materials. Regardless of its orientation, the package shall completely contain the contents in case of breakage or leakage;
- .3 The intermediate packaging shall be securely packed in a strong, rigid outer packaging (wooden, fibre-board or other equally strong material);
- .4 Each package type shall be in compliance with the provisions in 3.5.3;
- .5 Each package shall be of such a size that there is adequate space to apply all necessary marks; and
- .6 Overpacks may be used and may also contain packages of dangerous goods or goods not subject to the provisions of this Code.

## 3.5.3 Tests for packages

3.5.3.1 The complete package as prepared for transport, with inner packagings filled to not less than 95% of their capacity for solids or 98% for liquids, shall be capable of withstanding, as demonstrated by testing which is appropriately documented, without breakage or leakage of any inner packaging and without significant reduction in effectiveness:

- .1 Drops onto a rigid, non-resilient flat and horizontal surface from a height of 1.8 m:
  - (i) Where the sample is in the shape of a box, it shall be dropped in each of the following orientations:
    - flat on the base;
    - flat on the top;
    - flat on the longest side;
    - flat on the shortest side;
    - on a corner
  - (ii) Where the sample is in the shape of a drum, it shall be dropped in each of the following orientations:
    - diagonally on the top chime, with the centre of gravity directly above the point of impact;
    - diagonally on the base chime;
    - flat on the side.

**Note:** Each of the above drops may be performed on different but identical packages.

- .2 A force applied to the top surface for a duration of 24 h, equivalent to the total weight of identical packages if stacked to a height of 3 m (including the sample).

3.5.3.2 For the purposes of testing, the substances to be transported in the packaging may be replaced by other substances except where this would invalidate the results of the tests. For solids, when another substance is used, it shall have the same physical characteristics (mass, grain size, etc.) as the substance to be carried. In the drop tests for liquids, when another substance is used, its relative density (specific gravity) and viscosity shall be similar to those of the substance to be transported.

## 3.5.4 Marking of packages

3.5.4.1 Packages containing excepted quantities of dangerous goods prepared in accordance with this chapter shall be durably and legibly marked with the mark shown below. The primary hazard class of each of the dangerous goods contained in the package shall be shown in the mark. Where the name of the consignor or consignee is not shown elsewhere on the package, this information shall be included within the mark.



## 3.5.4.2

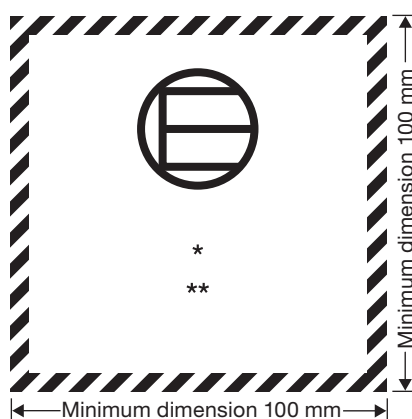

Excepted quantities mark

\* The class or, when assigned, the division number(s) shall be shown in this location.

\*\* The name of the consignor or of the consignee shall be shown in this location if not shown elsewhere on the package.

The mark shall be in the form of a square. The hatching and symbol shall be of the same colour, black or red, on white or suitable contrasting background. The minimum dimensions shall be 100 mm × 100 mm. Where dimensions are not specified, all features shall be in approximate proportion to those shown.

## 3.5.4.3

When packages containing dangerous goods packed in excepted quantities are placed in an overpack or in a unit load, the overpack or the unit load shall be marked with the mark required by this chapter unless the marks representative of all dangerous goods in the overpack or the unit load are visible. In addition, an overpack shall be marked with the word “OVERPACK” unless marks representative of all dangerous goods, as required by this chapter, in the overpack are visible. The lettering of the “OVERPACK” mark shall be at least 12 mm high. The other provisions of 5.1.2.1 apply only if other dangerous goods which are not packed in excepted quantities are contained in the overpack or in a unit load and only in relation to these other dangerous goods.

## 3.5.5 Maximum number of packages in any cargo transport unit

3.5.5.1 The number of packages containing dangerous goods packed in excepted quantities in any cargo transport unit shall not exceed 1,000.

## 3.5.6 Documentation

3.5.6.1 In addition to the provisions for documentation specified in chapter 5.4, the words “dangerous goods in excepted quantities” and the number of packages shall be included on the dangerous goods transport document together with the description of the shipment.

## 3.5.7 Stowage

3.5.7.1 Dangerous goods packed in excepted quantity are allocated stowage category A as defined in 7.1.3.2. The other stowage provisions indicated in column 16a of the Dangerous Goods List are not applicable.

## 3.5.8 Segregation

3.5.8.1 The segregation provisions of chapters 7.2 to 7.7, including the segregation provisions in column 16b of the Dangerous Goods List, are not applicable for packagings containing dangerous goods packed in excepted quantities or in relation to other dangerous goods.

3.5.8.2 The segregation provisions of chapters 7.2 to 7.7, including the segregation provisions in column 16b of the Dangerous Goods List, are not applicable for different dangerous goods in excepted quantities in the same outer packaging provided that they do not react dangerously with each other (see 4.1.1.6).



# APPENDICES



## Appendix A

---

### *List of generic and N.O.S. proper shipping names*

Substances or articles not mentioned specifically by name in the Dangerous Goods List in chapter 3.2 shall be classified in accordance with 3.1.1.2. Thus the name in the Dangerous Goods List which most appropriately describes the substance or article shall be used as the proper shipping name. The main generic entries and all the N.O.S. entries given in the Dangerous Goods List are listed below. This proper shipping name shall be supplemented by the technical name when special provision 274 or 318 has been assigned to the entry in column 6 of the Dangerous Goods List. For marine pollutants, see also 3.1.2.9.

In this list, general and N.O.S. names are grouped according to their hazard class or division. Within each hazard class or division, the names have been placed into three groups as follows:

- specific entries covering a group of substances or articles of a particular chemical or technical nature;
- pesticide entries, for class 3 and class 6.1;
- general entries covering a group of substances or articles having one or more general dangerous properties.

THE MOST SPECIFIC APPLICABLE NAME SHALL ALWAYS BE USED.

Appendices

| Class or division | Subsidiary hazard | UN No. | Proper shipping name  |
|-------------------|-------------------|--------|---|
| 1                 |                   | 0190   | <b>CLASS 1</b><br>SAMPLES, EXPLOSIVE, other than initiating explosive             |
|                   |                   |        | <b>Division 1.1</b>   |
| 1.1A              |                   | 0473   | SUBSTANCES, EXPLOSIVE, N.O.S.   |
| 1.1B              |                   | 0461   | COMPONENTS, EXPLOSIVE TRAIN, N.O.S.   |
| 1.1C              |                   | 0462   | ARTICLES, EXPLOSIVE, N.O.S.   |
| 1.1C              |                   | 0474   | SUBSTANCES, EXPLOSIVE, N.O.S.   |
| 1.1C              |                   | 0497   | PROPELLANT, LIQUID  |
| 1.1C              |                   | 0498   | PROPELLANT, SOLID   |
| 1.1D              |                   | 0463   | ARTICLES, EXPLOSIVE, N.O.S.   |
| 1.1D              |                   | 0475   | SUBSTANCES, EXPLOSIVE, N.O.S.   |
| 1.1E              |                   | 0464   | ARTICLES, EXPLOSIVE, N.O.S.   |
| 1.1F              |                   | 0465   | ARTICLES, EXPLOSIVE, N.O.S.   |
| 1.1G              |                   | 0476   | SUBSTANCES, EXPLOSIVE, N.O.S.   |
| 1.1L              |                   | 0354   | ARTICLES, EXPLOSIVE, N.O.S.   |
| 1.1L              |                   | 0357   | SUBSTANCES, EXPLOSIVE, N.O.S.   |
|                   |                   |        | <b>Division 1.2</b>   |
| 1.2B              |                   | 0382   | COMPONENTS, EXPLOSIVE TRAIN, N.O.S.   |
| 1.2C              |                   | 0466   | ARTICLES, EXPLOSIVE, N.O.S.   |
| 1.2D              |                   | 0467   | ARTICLES, EXPLOSIVE, N.O.S.   |
| 1.2E              |                   | 0468   | ARTICLES, EXPLOSIVE, N.O.S.   |
| 1.2F              |                   | 0469   | ARTICLES, EXPLOSIVE, N.O.S.   |
| 1.2K              | 6.1               | 0020   | AMMUNITION, TOXIC with burster, expelling charge or propelling charge             |
| 1.2L              | 4.3               | 0248   | CONTRIVANCES, WATER-ACTIVATED with burster, expelling charge or propelling charge |
| 1.2L              |                   | 0355   | ARTICLES, EXPLOSIVE, N.O.S.   |
| 1.2L              |                   | 0358   | SUBSTANCES, EXPLOSIVE, N.O.S.   |
|                   |                   |        | <b>Division 1.3</b>   |
| 1.3C              |                   | 0132   | DEFLAGRATING METAL SALTS OF AROMATIC NITRO-DERIVATIVES, N.O.S.                    |
| 1.3C              |                   | 0470   | ARTICLES, EXPLOSIVE, N.O.S.   |
| 1.3C              |                   | 0477   | SUBSTANCES, EXPLOSIVE, N.O.S.   |
| 1.3C              |                   | 0495   | PROPELLANT, LIQUID  |
| 1.3C              |                   | 0499   | PROPELLANT, SOLID   |
| 1.3G              |                   | 0478   | SUBSTANCES, EXPLOSIVE, N.O.S.   |
| 1.3K              | 6.1               | 0021   | AMMUNITION, TOXIC with burster, expelling charge or propelling charge             |
| 1.3L              | 4.3               | 0249   | CONTRIVANCES, WATER-ACTIVATED with burster, expelling charge or propelling charge |
| 1.3L              |                   | 0356   | ARTICLES, EXPLOSIVE, N.O.S.   |
| 1.3L              |                   | 0359   | SUBSTANCES, EXPLOSIVE, N.O.S.   |
|                   |                   |        | <b>Division 1.4</b>   |
| 1.4B              |                   | 0350   | ARTICLES, EXPLOSIVE, N.O.S.   |
| 1.4B              |                   | 0383   | COMPONENTS, EXPLOSIVE TRAIN, N.O.S.   |
| 1.4C              |                   | 0351   | ARTICLES, EXPLOSIVE, N.O.S.   |
| 1.4C              |                   | 0479   | SUBSTANCES, EXPLOSIVE, N.O.S.   |
| 1.4C              |                   | 0501   | PROPELLANT, SOLID   |
| 1.4D              |                   | 0352   | ARTICLES, EXPLOSIVE, N.O.S.   |
| 1.4D              |                   | 0480   | SUBSTANCES, EXPLOSIVE, N.O.S.   |
| 1.4E              |                   | 0471   | ARTICLES, EXPLOSIVE, N.O.S.   |
| 1.4F              |                   | 0472   | ARTICLES, EXPLOSIVE, N.O.S.   |
| 1.4G              |                   | 0353   | ARTICLES, EXPLOSIVE, N.O.S.   |
| 1.4G              |                   | 0485   | SUBSTANCES, EXPLOSIVE, N.O.S.   |
| 1.4S              |                   | 0349   | ARTICLES, EXPLOSIVE, N.O.S.   |
| 1.4S              |                   | 0384   | COMPONENTS, EXPLOSIVE TRAIN, N.O.S.   |
| 1.4S              |                   | 0481   | SUBSTANCES, EXPLOSIVE, N.O.S.   |
|                   |                   |        | <b>Division 1.5</b>   |
| 1.5D              |                   | 0482   | SUBSTANCES, EXPLOSIVE, VERY INSENSITIVE (SUBSTANCES, EVI), N.O.S.                 |
|                   |                   |        | <b>Division 1.6</b>   |
| 1.6N              |                   | 0486   | ARTICLES, EXPLOSIVE, EXTREMELY INSENSITIVE (ARTICLES, EEI)                        |

Appendix A – List of generic and N.O.S. proper shipping names

| Class or division       | Subsidiary hazard | UN No. | Proper shipping name   |
|-------------------------|-------------------|--------|--|
| <b>CLASS 2</b>          |                   |        |  |
| <b>Class 2.1</b>        |                   |        |  |
| <b>Specific entries</b> |                   |        |  |
| 2.1                     |                   | 1964   | HYDROCARBON GAS MIXTURE, COMPRESSED, N.O.S.                                    |
| 2.1                     |                   | 1965   | HYDROCARBON GAS MIXTURE, LIQUEFIED, N.O.S.                                     |
| 2.1                     |                   | 3354   | INSECTICIDE GAS, FLAMMABLE, N.O.S.   |
| <b>General entries</b>  |                   |        |  |
| 2.1                     |                   | 1954   | COMPRESSED GAS, FLAMMABLE, N.O.S.  |
| 2.1                     |                   | 3161   | LIQUEFIED GAS, FLAMMABLE, N.O.S.   |
| 2.1                     |                   | 3167   | GAS SAMPLE, NON-PRESSURIZED, FLAMMABLE, N.O.S., not refrigerated liquid        |
| 2.1                     |                   | 3312   | GAS, REFRIGERATED LIQUID, FLAMMABLE, N.O.S.                                    |
| 2.1                     |                   | 3501   | CHEMICAL UNDER PRESSURE, FLAMMABLE, N.O.S.                                     |
| 2.1                     |                   | 3510   | ADSORBED GAS, FLAMMABLE, N.O.S.  |
| 2.1                     | See 2.0.6.6       | 3537   | ARTICLES CONTAINING FLAMMABLE GAS, N.O.S.                                      |
| 2.1                     | 6.1               | 3504   | CHEMICAL UNDER PRESSURE, FLAMMABLE, TOXIC, N.O.S.                              |
| 2.1                     | 8                 | 3505   | CHEMICAL UNDER PRESSURE, FLAMMABLE, CORROSIVE, N.O.S.                          |
| <b>Class 2.2</b>        |                   |        |  |
| <b>Specific entries</b> |                   |        |  |
| 2.2                     |                   | 1078   | REFRIGERANT GAS, N.O.S.  |
| 2.2                     |                   | 1968   | INSECTICIDE GAS, N.O.S.  |
| <b>General entries</b>  |                   |        |  |
| 2.2                     |                   | 1956   | COMPRESSED GAS, N.O.S.   |
| 2.2                     |                   | 3163   | LIQUEFIED GAS, N.O.S.  |
| 2.2                     |                   | 3158   | GAS, REFRIGERATED LIQUID, N.O.S.   |
| 2.2                     |                   | 3500   | CHEMICAL UNDER PRESSURE, N.O.S.  |
| 2.2                     |                   | 3511   | ADSORBED GAS, N.O.S.   |
| 2.2                     | See 2.0.6.6       | 3538   | ARTICLES CONTAINING NON-FLAMMABLE, NON-TOXIC GAS, N.O.S.                       |
| 2.2                     | 5.1               | 3156   | COMPRESSED GAS, OXIDIZING, N.O.S.  |
| 2.2                     | 5.1               | 3157   | LIQUEFIED GAS, OXIDIZING, N.O.S.   |
| 2.2                     | 5.1               | 3311   | GAS, REFRIGERATED LIQUID, OXIDIZING, N.O.S.                                    |
| 2.2                     | 5.1               | 3513   | ADSORBED GAS, OXIDIZING, N.O.S.  |
| 2.2                     | 6.1               | 3502   | CHEMICAL UNDER PRESSURE, TOXIC, N.O.S.   |
| 2.2                     | 8                 | 3503   | CHEMICAL UNDER PRESSURE, CORROSIVE, N.O.S.                                     |
| <b>Class 2.3</b>        |                   |        |  |
| <b>Specific entries</b> |                   |        |  |
| 2.3                     |                   | 1967   | INSECTICIDE GAS, TOXIC, N.O.S.   |
| 2.3                     | 2.1               | 3355   | INSECTICIDE GAS, TOXIC, FLAMMABLE, N.O.S.                                      |
| <b>General entries</b>  |                   |        |  |
| 2.3                     |                   | 1955   | COMPRESSED GAS, TOXIC, N.O.S.  |
| 2.3                     |                   | 3162   | LIQUEFIED GAS, TOXIC, N.O.S.   |
| 2.3                     |                   | 3169   | GAS SAMPLE, NON-PRESSURIZED, TOXIC, N.O.S., not refrigerated liquid            |
| 2.3                     |                   | 3512   | ADSORBED GAS, TOXIC, N.O.S.  |
| 2.3                     | See 2.0.6.6       | 3539   | ARTICLES CONTAINING TOXIC GAS, N.O.S.  |
| 2.3                     | 2.1               | 1953   | COMPRESSED GAS, TOXIC, FLAMMABLE, N.O.S.                                       |
| 2.3                     | 2.1               | 3160   | LIQUEFIED GAS, TOXIC, FLAMMABLE, N.O.S.  |
| 2.3                     | 2.1               | 3168   | GAS SAMPLE, NON-PRESSURIZED, TOXIC, FLAMMABLE, N.O.S., not refrigerated liquid |
| 2.3                     | 2.1               | 3514   | ADSORBED GAS, TOXIC, FLAMMABLE, N.O.S.   |
| 2.3                     | 2.1 + 8           | 3305   | COMPRESSED GAS, TOXIC, FLAMMABLE, CORROSIVE, N.O.S.                            |
| 2.3                     | 2.1 + 8           | 3309   | LIQUEFIED GAS, TOXIC, FLAMMABLE, CORROSIVE, N.O.S.                             |
| 2.3                     | 2.1 + 8           | 3517   | ADSORBED GAS, TOXIC, FLAMMABLE, CORROSIVE, N.O.S.                              |
| 2.3                     | 5.1               | 3303   | COMPRESSED GAS, TOXIC, OXIDIZING, N.O.S.                                       |
| 2.3                     | 5.1               | 3307   | LIQUEFIED GAS, TOXIC, OXIDIZING, N.O.S.  |
| 2.3                     | 5.1               | 3515   | ADSORBED GAS, TOXIC, OXIDIZING, N.O.S.   |
| 2.3                     | 5.1 + 8           | 3306   | COMPRESSED GAS, TOXIC, OXIDIZING, CORROSIVE, N.O.S.                            |



Appendices

| Class or division | Subsidiary hazard | UN No. | Proper shipping name                               |
|-------------------|-------------------|--------|--|
|                   |                   |        | <b>CLASS 2 (continued)</b>                         |
|                   |                   |        | <b>Class 2.3 (continued)</b>                       |
| 2.3               | 5.1 + 8           | 3310   | LIQUEFIED GAS, TOXIC, OXIDIZING, CORROSIVE, N.O.S. |
| 2.3               | 5.1 + 8           | 3518   | ADSORBED GAS, TOXIC, OXIDIZING, CORROSIVE, N.O.S.  |
| 2.3               | 8                 | 3304   | COMPRESSED GAS, TOXIC, CORROSIVE, N.O.S.           |
| 2.3               | 8                 | 3308   | LIQUEFIED GAS, TOXIC, CORROSIVE, N.O.S.            |
| 2.3               | 8                 | 3516   | ADSORBED GAS, TOXIC, CORROSIVE, N.O.S.             |

APPENDIX A

Appendix A – List of generic and N.O.S. proper shipping names

| Class or division       | Subsidiary hazard | UN No. | Proper shipping name   |
|-------------------------|-------------------|--------|--|
| <b>CLASS 3</b>          |                   |        |  |
| <b>Specific entries</b> |                   |        |  |
| 3                       |                   | 1224   | KETONES, LIQUID, N.O.S.  |
| 3                       |                   | 1268   | PETROLEUM DISTILLATES, N.O.S. or PETROLEUM PRODUCTS, N.O.S.  |
| 3                       |                   | 1987   | ALCOHOLS, N.O.S.   |
| 3                       |                   | 1989   | ALDEHYDES, N.O.S.  |
| 3                       |                   | 2319   | TERPENE HYDROCARBONS, N.O.S.   |
| 3                       |                   | 3271   | ETHERS, N.O.S.   |
| 3                       |                   | 3272   | ESTERS, N.O.S.   |
| 3                       |                   | 3295   | HYDROCARBONS, LIQUID, N.O.S.   |
| 3                       |                   | 3336   | MERCAPTANS, LIQUID, FLAMMABLE, N.O.S. or MERCAPTAN MIXTURE, LIQUID, FLAMMABLE, N.O.S.                        |
| 3                       |                   | 3343   | NITROGLYCERIN MIXTURE, DESENSITIZED, LIQUID, FLAMMABLE, N.O.S. with not more than 30% nitroglycerin, by mass |
| 3                       |                   | 3357   | NITROGLYCERIN MIXTURE, DESENSITIZED, LIQUID, N.O.S. with not more than 30% nitroglycerin, by mass            |
| 3                       |                   | 3379   | DESENSITIZED EXPLOSIVE, LIQUID, N.O.S.   |
| 3                       | 6.1               | 1228   | MERCAPTANS, LIQUID, FLAMMABLE, TOXIC, N.O.S. or MERCAPTAN MIXTURE, LIQUID, FLAMMABLE, TOXIC, N.O.S.          |
| 3                       | 6.1               | 1986   | ALCOHOLS, FLAMMABLE, TOXIC, N.O.S.   |
| 3                       | 6.1               | 1988   | ALDEHYDES, FLAMMABLE, TOXIC, N.O.S.  |
| 3                       | 6.1               | 2478   | ISOCYANATES, FLAMMABLE, TOXIC, N.O.S. or ISOCYANATE SOLUTION, FLAMMABLE, TOXIC, N.O.S.                       |
| 3                       | 6.1               | 3248   | MEDICINE, LIQUID, FLAMMABLE, TOXIC, N.O.S.   |
| 3                       | 6.1               | 3273   | NITRILES, FLAMMABLE, TOXIC, N.O.S.   |
| 3                       | 8                 | 2733   | AMINES, FLAMMABLE, CORROSIVE, N.O.S. or POLYAMINES, FLAMMABLE, CORROSIVE, N.O.S.                             |
| 3                       | 8                 | 2985   | CHLOROSILANES, FLAMMABLE, CORROSIVE, N.O.S.  |
| 3                       | 8                 | 3274   | ALCOHOLATES SOLUTION, N.O.S. in alcohol  |
| <b>Pesticides</b>       |                   |        |  |
| 3                       | 6.1               | 2758   | CARBAMATE PESTICIDE, LIQUID, FLAMMABLE, TOXIC flashpoint < 23°C  |
| 3                       | 6.1               | 2760   | ARSENICAL PESTICIDE, LIQUID, FLAMMABLE, TOXIC flashpoint < 23°C  |
| 3                       | 6.1               | 2762   | ORGANOCHLORINE PESTICIDE, LIQUID, FLAMMABLE, TOXIC flashpoint < 23°C   |
| 3                       | 6.1               | 2764   | TRIAZINE PESTICIDE, LIQUID, FLAMMABLE, TOXIC flashpoint < 23°C   |
| 3                       | 6.1               | 2772   | THIOCARBAMATE PESTICIDE, LIQUID, FLAMMABLE, TOXIC flashpoint < 23°C  |
| 3                       | 6.1               | 2776   | COPPER BASED PESTICIDE, LIQUID, FLAMMABLE, TOXIC flashpoint < 23°C   |
| 3                       | 6.1               | 2778   | MERCURY BASED PESTICIDE, LIQUID, FLAMMABLE, TOXIC flashpoint < 23°C  |
| 3                       | 6.1               | 2780   | SUBSTITUTED NITROPHENOL PESTICIDE, LIQUID, FLAMMABLE, TOXIC flashpoint < 23°C                                |
| 3                       | 6.1               | 2782   | BIPYRIDILIUM PESTICIDE, LIQUID, FLAMMABLE, TOXIC flashpoint < 23°C   |
| 3                       | 6.1               | 2784   | ORGANOPHOSPHORUS PESTICIDE, LIQUID, FLAMMABLE, TOXIC flashpoint < 23°C                                       |
| 3                       | 6.1               | 2787   | ORGANOTIN PESTICIDE, LIQUID, FLAMMABLE, TOXIC flashpoint < 23°C  |
| 3                       | 6.1               | 3021   | PESTICIDE, LIQUID, FLAMMABLE, TOXIC, N.O.S. flashpoint < 23°C  |
| 3                       | 6.1               | 3024   | COUMARIN DERIVATIVE PESTICIDE, LIQUID, FLAMMABLE, TOXIC flashpoint < 23°C                                    |
| 3                       | 6.1               | 3346   | PHENOXYACETIC ACID DERIVATIVE PESTICIDE, LIQUID, FLAMMABLE, TOXIC flashpoint < 23°C                          |
| 3                       | 6.1               | 3350   | PYRETHROID PESTICIDE, LIQUID, FLAMMABLE, TOXIC flashpoint < 23°C   |
| <b>General entries</b>  |                   |        |  |
| 3                       |                   | 1993   | FLAMMABLE LIQUID, N.O.S.   |
| 3                       |                   | 3256   | ELEVATED TEMPERATURE LIQUID, FLAMMABLE, N.O.S. with flashpoint above 60°C, at or above its flashpoint        |
| 3                       | See 2.0.6.6       | 3540   | ARTICLES CONTAINING FLAMMABLE LIQUID, N.O.S.   |
| 3                       | 6.1               | 1992   | FLAMMABLE LIQUID, TOXIC, N.O.S.  |
| 3                       | 6.1 + 8           | 3286   | FLAMMABLE LIQUID, TOXIC, CORROSIVE, N.O.S.   |
| 3                       | 8                 | 2924   | FLAMMABLE LIQUID, CORROSIVE, N.O.S.  |

Appendices

| Class or division | Subsidiary hazard | UN No. | Proper shipping name  |
|-------------------|-------------------|--------|---|
|                   |                   |        | <b>CLASS 4</b>  |
|                   |                   |        | <b>Class 4.1</b>  |
|                   |                   |        | <b>Specific entries</b>   |
| 4.1               |                   | 1353   | FIBRES or FABRICS IMPREGNATED WITH WEAKLY NITRATED NITROCELLULOSE, N.O.S.   |
| 4.1               |                   | 3089   | METAL POWDER, FLAMMABLE, N.O.S.   |
| 4.1               |                   | 3182   | METAL HYDRIDES, FLAMMABLE, N.O.S.   |
| 4.1               |                   | 3221   | SELF-REACTIVE LIQUID TYPE B   |
| 4.1               |                   | 3222   | SELF-REACTIVE SOLID TYPE B  |
| 4.1               |                   | 3223   | SELF-REACTIVE LIQUID TYPE C   |
| 4.1               |                   | 3224   | SELF-REACTIVE SOLID TYPE C  |
| 4.1               |                   | 3225   | SELF-REACTIVE LIQUID TYPE D   |
| 4.1               |                   | 3226   | SELF-REACTIVE SOLID TYPE D  |
| 4.1               |                   | 3227   | SELF-REACTIVE LIQUID TYPE E   |
| 4.1               |                   | 3228   | SELF-REACTIVE SOLID TYPE E  |
| 4.1               |                   | 3229   | SELF-REACTIVE LIQUID TYPE F   |
| 4.1               |                   | 3230   | SELF-REACTIVE SOLID TYPE F  |
| 4.1               |                   | 3231   | SELF-REACTIVE LIQUID TYPE B, TEMPERATURE CONTROLLED   |
| 4.1               |                   | 3232   | SELF-REACTIVE SOLID TYPE B, TEMPERATURE CONTROLLED  |
| 4.1               |                   | 3233   | SELF-REACTIVE LIQUID TYPE C, TEMPERATURE CONTROLLED   |
| 4.1               |                   | 3234   | SELF-REACTIVE SOLID TYPE C, TEMPERATURE CONTROLLED  |
| 4.1               |                   | 3235   | SELF-REACTIVE LIQUID TYPE D, TEMPERATURE CONTROLLED   |
| 4.1               |                   | 3236   | SELF-REACTIVE SOLID TYPE D, TEMPERATURE CONTROLLED  |
| 4.1               |                   | 3237   | SELF-REACTIVE LIQUID TYPE E, TEMPERATURE CONTROLLED   |
| 4.1               |                   | 3238   | SELF-REACTIVE SOLID TYPE E, TEMPERATURE CONTROLLED  |
| 4.1               |                   | 3239   | SELF-REACTIVE LIQUID TYPE F, TEMPERATURE CONTROLLED   |
| 4.1               |                   | 3240   | SELF-REACTIVE SOLID TYPE F, TEMPERATURE CONTROLLED  |
| 4.1               |                   | 3319   | NITROGLYCERIN MIXTURE, DESENSITIZED, SOLID, N.O.S. with more than 2% but not more than 10% nitroglycerin, by mass   |
| 4.1               |                   | 3344   | PENTAERYTHRITOL TETRANITRATE (PENTAERYTHRITOL TETRANITRATE; PETN) MIXTURE, DESENSITIZED, SOLID, N.O.S. with more than 10% but not more than 20% PETN, by mass |
| 4.1               |                   | 3380   | DESENSITIZED EXPLOSIVE, SOLID, N.O.S.   |
| 4.1               |                   | 3531   | POLYMERIZING SUBSTANCE, SOLID, STABILIZED, N.O.S.   |
| 4.1               |                   | 3532   | POLYMERIZING SUBSTANCE, LIQUID, STABILIZED, N.O.S.  |
| 4.1               |                   | 3533   | POLYMERIZING SUBSTANCE, SOLID, TEMPERATURE CONTROLLED, N.O.S.   |
| 4.1               |                   | 3534   | POLYMERIZING SUBSTANCE, LIQUID, TEMPERATURE CONTROLLED, N.O.S.  |
|                   |                   |        | <b>General entries</b>  |
| 4.1               |                   | 1325   | FLAMMABLE SOLID, ORGANIC, N.O.S.  |
| 4.1               |                   | 3175   | SOLIDS CONTAINING FLAMMABLE LIQUID, N.O.S.  |
| 4.1               |                   | 3176   | FLAMMABLE SOLID, ORGANIC, MOLTEN, N.O.S.  |
| 4.1               |                   | 3178   | FLAMMABLE SOLID, INORGANIC, N.O.S.  |
| 4.1               |                   | 3181   | METAL SALTS OF ORGANIC COMPOUNDS, FLAMMABLE, N.O.S.   |
| 4.1               | See 2.0.6.6       | 3541   | ARTICLES CONTAINING FLAMMABLE SOLID, N.O.S.   |
| 4.1               | 5.1               | 3097   | FLAMMABLE SOLID, OXIDIZING, N.O.S.  |
| 4.1               | 6.1               | 2926   | FLAMMABLE SOLID, TOXIC, ORGANIC, N.O.S.   |
| 4.1               | 6.1               | 3179   | FLAMMABLE SOLID, TOXIC, INORGANIC, N.O.S.   |
| 4.1               | 8                 | 2925   | FLAMMABLE SOLID, CORROSIVE, ORGANIC, N.O.S.   |
| 4.1               | 8                 | 3180   | FLAMMABLE SOLID, CORROSIVE, INORGANIC, N.O.S.   |
|                   |                   |        | <b>Class 4.2</b>  |
|                   |                   |        | <b>Specific entries</b>   |
| 4.2               |                   | 1373   | FIBRES or FABRICS, ANIMAL or VEGETABLE or SYNTHETIC, N.O.S. with oil  |
| 4.2               |                   | 1378   | METAL CATALYST, WETTED with a visible excess of liquid  |
| 4.2               |                   | 1383   | PYROPHORIC METAL, N.O.S. or PYROPHORIC ALLOY, N.O.S.  |
| 4.2               |                   | 2006   | PLASTICS, NITROCELLULOSE-BASED, SELF-HEATING, N.O.S.  |
| 4.2               |                   | 2881   | METAL CATALYST, DRY   |
| 4.2               |                   | 3189   | METAL POWDER, SELF-HEATING, N.O.S.  |

Appendix A – List of generic and N.O.S. proper shipping names

| Class or division | Subsidiary hazard | UN No. | Proper shipping name   |
|-------------------|-------------------|--------|--|
|                   |                   |        | <b>CLASS 4 (continued)</b>   |
|                   |                   |        | <b>Class 4.2 (continued)</b>   |
|                   |                   |        | <b>Specific entries (continued)</b>  |
| 4.2               |                   | 3205   | ALKALINE EARTH METAL ALCOHOLATES, N.O.S.   |
| 4.2               |                   | 3313   | ORGANIC PIGMENTS, SELF-HEATING   |
| 4.2               |                   | 3342   | XANTHATES  |
| 4.2               |                   | 3391   | ORGANOMETALLIC SUBSTANCE, SOLID, PYROPHORIC                                      |
| 4.2               |                   | 3392   | ORGANOMETALLIC SUBSTANCE, LIQUID, PYROPHORIC                                     |
| 4.2               |                   | 3400   | ORGANOMETALLIC SUBSTANCE, SOLID, SELF-HEATING                                    |
| 4.2               | 4.3               | 3393   | ORGANOMETALLIC SUBSTANCE, SOLID, PYROPHORIC, WATER-REACTIVE                      |
| 4.2               | 4.3               | 3394   | ORGANOMETALLIC SUBSTANCE, LIQUID, PYROPHORIC, WATER-REACTIVE                     |
| 4.2               | 8                 | 3206   | ALKALI METAL ALCOHOLATES, SELF-HEATING, CORROSIVE, N.O.S.                        |
|                   |                   |        | <b>General entries</b>   |
| 4.2               |                   | 2845   | PYROPHORIC LIQUID, ORGANIC, N.O.S.   |
| 4.2               |                   | 2846   | PYROPHORIC SOLID, ORGANIC, N.O.S.  |
| 4.2               |                   | 3088   | SELF-HEATING SOLID, ORGANIC, N.O.S.  |
| 4.2               |                   | 3183   | SELF-HEATING LIQUID, ORGANIC, N.O.S.   |
| 4.2               |                   | 3186   | SELF-HEATING LIQUID, INORGANIC, N.O.S.   |
| 4.2               |                   | 3190   | SELF-HEATING SOLID, INORGANIC, N.O.S.  |
| 4.2               |                   | 3194   | PYROPHORIC LIQUID, INORGANIC, N.O.S.   |
| 4.2               |                   | 3200   | PYROPHORIC SOLID, INORGANIC, N.O.S.  |
| 4.2               | See 2.0.6.6       | 3542   | ARTICLES CONTAINING A SUBSTANCE LIABLE TO SPONTANEOUS COMBUSTION, N.O.S.         |
| 4.2               | 5.1               | 3127   | SELF-HEATING SOLID, OXIDIZING, N.O.S.  |
| 4.2               | 6.1               | 3128   | SELF-HEATING SOLID, TOXIC, ORGANIC, N.O.S.                                       |
| 4.2               | 6.1               | 3184   | SELF-HEATING LIQUID, TOXIC, ORGANIC, N.O.S.                                      |
| 4.2               | 6.1               | 3187   | SELF-HEATING LIQUID, TOXIC, INORGANIC, N.O.S.                                    |
| 4.2               | 6.1               | 3191   | SELF-HEATING SOLID, TOXIC, INORGANIC, N.O.S.                                     |
| 4.2               | 8                 | 3126   | SELF-HEATING SOLID, CORROSIVE, ORGANIC, N.O.S.                                   |
| 4.2               | 8                 | 3185   | SELF-HEATING LIQUID, CORROSIVE, ORGANIC, N.O.S.                                  |
| 4.2               | 8                 | 3188   | SELF-HEATING LIQUID, CORROSIVE, INORGANIC, N.O.S.                                |
| 4.2               | 8                 | 3192   | SELF-HEATING SOLID, CORROSIVE, INORGANIC, N.O.S.                                 |
|                   |                   |        | <b>Class 4.3</b>   |
|                   |                   |        | <b>Specific entries</b>  |
| 4.3               |                   | 1389   | ALKALI METAL AMALGAM, LIQUID   |
| 4.3               |                   | 1390   | ALKALI METAL AMIDES  |
| 4.3               |                   | 1391   | ALKALI METAL DISPERSION or ALKALINE EARTH METAL DISPERSION                       |
| 4.3               |                   | 1392   | ALKALINE EARTH METAL AMALGAM, LIQUID   |
| 4.3               |                   | 1393   | ALKALINE EARTH METAL ALLOY, N.O.S.   |
| 4.3               |                   | 1409   | METAL HYDRIDES, WATER-REACTIVE, N.O.S.   |
| 4.3               |                   | 1421   | ALKALI METAL ALLOY, LIQUID, N.O.S.   |
| 4.3               |                   | 3208   | METALLIC SUBSTANCE, WATER-REACTIVE, N.O.S.                                       |
| 4.3               |                   | 3395   | ORGANOMETALLIC SUBSTANCE, SOLID, WATER-REACTIVE                                  |
| 4.3               |                   | 3398   | ORGANOMETALLIC SUBSTANCE, LIQUID, WATER-REACTIVE                                 |
| 4.3               |                   | 3401   | ALKALI METAL AMALGAM, SOLID  |
| 4.3               |                   | 3402   | ALKALINE EARTH METAL AMALGAM, SOLID  |
| 4.3               | 3                 | 3399   | ORGANOMETALLIC SUBSTANCE, LIQUID, WATER-REACTIVE, FLAMMABLE                      |
| 4.3               | 3                 | 3482   | ALKALI METAL DISPERSION, FLAMMABLE or ALKALINE EARTH METAL DISPERSION, FLAMMABLE |
| 4.3               | 3 + 8             | 2988   | CHLOROSILANES, WATER-REACTIVE, FLAMMABLE, CORROSIVE, N.O.S.                      |
| 4.3               | 4.1               | 3396   | ORGANOMETALLIC SUBSTANCE, SOLID, WATER-REACTIVE, FLAMMABLE                       |
| 4.3               | 4.2               | 3209   | METALLIC SUBSTANCE, WATER-REACTIVE, SELF-HEATING, N.O.S.                         |
| 4.3               | 4.2               | 3397   | ORGANOMETALLIC SUBSTANCE, SOLID, WATER-REACTIVE, SELF-HEATING                    |
|                   |                   |        | <b>General entries</b>   |
| 4.3               |                   | 3148   | WATER-REACTIVE LIQUID, N.O.S.  |
| 4.3               |                   | 2813   | WATER-REACTIVE SOLID, N.O.S.   |

Appendices

| Class or division | Subsidiary hazard | UN No. | Proper shipping name  |
|-------------------|-------------------|--------|---|
|                   |                   |        | <b>CLASS 4 (continued)</b>  |
|                   |                   |        | <b>Class 4.3 (continued)</b>  |
| 4.3               | See 2.0.6.6       | 3543   | ARTICLES CONTAINING A SUBSTANCE WHICH IN CONTACT WITH WATER EMITS FLAMMABLE GASES, N.O.S. |
| 4.3               | 4.1               | 3132   | WATER-REACTIVE SOLID, FLAMMABLE, N.O.S.   |
| 4.3               | 4.2               | 3135   | WATER-REACTIVE SOLID, SELF-HEATING, N.O.S.  |
| 4.3               | 5.1               | 3133   | WATER-REACTIVE SOLID, OXIDIZING, N.O.S.   |
| 4.3               | 6.1               | 3130   | WATER-REACTIVE LIQUID, TOXIC, N.O.S.  |
| 4.3               | 6.1               | 3134   | WATER-REACTIVE SOLID, TOXIC, N.O.S.   |
| 4.3               | 8                 | 3129   | WATER-REACTIVE LIQUID, CORROSIVE, N.O.S.  |
| 4.3               | 8                 | 3131   | WATER-REACTIVE SOLID, CORROSIVE, N.O.S.   |

Appendix A – List of generic and N.O.S. proper shipping names

| Class or division | Subsidiary hazard | UN No. | Proper shipping name                                    |
|-------------------|-------------------|--------|---|
|                   |                   |        | <b>CLASS 5</b>  |
|                   |                   |        | <b>Class 5.1</b>  |
|                   |                   |        | <b>Specific entries</b>                                 |
| 5.1               |                   | 1450   | BROMATES, INORGANIC, N.O.S.                             |
| 5.1               |                   | 1461   | CHLORATES, INORGANIC, N.O.S.                            |
| 5.1               |                   | 1462   | CHLORITES, INORGANIC, N.O.S.                            |
| 5.1               |                   | 1477   | NITRATES, INORGANIC, N.O.S.                             |
| 5.1               |                   | 1481   | PERCHLORATES, INORGANIC, N.O.S.                         |
| 5.1               |                   | 1482   | PERMANGANATES, INORGANIC, N.O.S.                        |
| 5.1               |                   | 1483   | PEROXIDES, INORGANIC, N.O.S.                            |
| 5.1               |                   | 2627   | NITRITES, INORGANIC, N.O.S.                             |
| 5.1               |                   | 3210   | CHLORATES, INORGANIC, AQUEOUS SOLUTION, N.O.S.          |
| 5.1               |                   | 3211   | PERCHLORATES, INORGANIC, AQUEOUS SOLUTION, N.O.S.       |
| 5.1               |                   | 3212   | HYPOCHLORITES, INORGANIC, N.O.S.                        |
| 5.1               |                   | 3213   | BROMATES, INORGANIC, AQUEOUS SOLUTION, N.O.S.           |
| 5.1               |                   | 3214   | PERMANGANATES, INORGANIC, AQUEOUS SOLUTION, N.O.S.      |
| 5.1               |                   | 3215   | PERSULPHATES, INORGANIC, N.O.S.                         |
| 5.1               |                   | 3216   | PERSULPHATES, INORGANIC, AQUEOUS SOLUTION, N.O.S.       |
| 5.1               |                   | 3218   | NITRATES, INORGANIC, AQUEOUS SOLUTION, N.O.S.           |
| 5.1               |                   | 3219   | NITRITES, INORGANIC, AQUEOUS SOLUTION, N.O.S.           |
|                   |                   |        | <b>General entries</b>                                  |
| 5.1               |                   | 1479   | OXIDIZING SOLID, N.O.S.                                 |
| 5.1               |                   | 3139   | OXIDIZING LIQUID, N.O.S.                                |
| 5.1               | See 2.0.6.6       | 3544   | ARTICLES CONTAINING OXIDIZING SUBSTANCE, N.O.S.         |
| 5.1               | 4.1               | 3137   | OXIDIZING SOLID, FLAMMABLE, N.O.S.                      |
| 5.1               | 4.2               | 3100   | OXIDIZING SOLID, SELF-HEATING, N.O.S.                   |
| 5.1               | 4.3               | 3121   | OXIDIZING SOLID, WATER-REACTIVE, N.O.S.                 |
| 5.1               | 6.1               | 3087   | OXIDIZING SOLID, TOXIC, N.O.S.                          |
| 5.1               | 6.1               | 3099   | OXIDIZING LIQUID, TOXIC, N.O.S.                         |
| 5.1               | 8                 | 3085   | OXIDIZING SOLID, CORROSIVE, N.O.S.                      |
| 5.1               | 8                 | 3098   | OXIDIZING LIQUID, CORROSIVE, N.O.S.                     |
|                   |                   |        | <b>Class 5.2</b>  |
|                   |                   |        | <b>Specific entries</b>                                 |
| 5.2               |                   | 3101   | ORGANIC PEROXIDE TYPE B, LIQUID                         |
| 5.2               |                   | 3102   | ORGANIC PEROXIDE TYPE B, SOLID                          |
| 5.2               |                   | 3103   | ORGANIC PEROXIDE TYPE C, LIQUID                         |
| 5.2               |                   | 3104   | ORGANIC PEROXIDE TYPE C, SOLID                          |
| 5.2               |                   | 3105   | ORGANIC PEROXIDE TYPE D, LIQUID                         |
| 5.2               |                   | 3106   | ORGANIC PEROXIDE TYPE D, SOLID                          |
| 5.2               |                   | 3107   | ORGANIC PEROXIDE TYPE E, LIQUID                         |
| 5.2               |                   | 3108   | ORGANIC PEROXIDE TYPE E, SOLID                          |
| 5.2               |                   | 3109   | ORGANIC PEROXIDE TYPE F, LIQUID                         |
| 5.2               |                   | 3110   | ORGANIC PEROXIDE TYPE F, SOLID                          |
| 5.2               |                   | 3111   | ORGANIC PEROXIDE TYPE B, LIQUID, TEMPERATURE CONTROLLED |
| 5.2               |                   | 3112   | ORGANIC PEROXIDE TYPE B, SOLID, TEMPERATURE CONTROLLED  |
| 5.2               |                   | 3113   | ORGANIC PEROXIDE TYPE C, LIQUID, TEMPERATURE CONTROLLED |
| 5.2               |                   | 3114   | ORGANIC PEROXIDE TYPE C, SOLID, TEMPERATURE CONTROLLED  |
| 5.2               |                   | 3115   | ORGANIC PEROXIDE TYPE D, LIQUID, TEMPERATURE CONTROLLED |
| 5.2               |                   | 3116   | ORGANIC PEROXIDE TYPE D, SOLID, TEMPERATURE CONTROLLED  |
| 5.2               |                   | 3117   | ORGANIC PEROXIDE TYPE E, LIQUID, TEMPERATURE CONTROLLED |
| 5.2               |                   | 3118   | ORGANIC PEROXIDE TYPE E, SOLID, TEMPERATURE CONTROLLED  |
| 5.2               |                   | 3119   | ORGANIC PEROXIDE TYPE F, LIQUID, TEMPERATURE CONTROLLED |
| 5.2               |                   | 3120   | ORGANIC PEROXIDE TYPE F, SOLID, TEMPERATURE CONTROLLED  |
|                   |                   |        | <b>General entries</b>                                  |
| 5.2               | See 2.0.6.6       | 3545   | ARTICLES CONTAINING ORGANIC PEROXIDE, N.O.S.            |



Appendices

| Class or division | Subsidiary hazard | UN No. | Proper shipping name   |
|-------------------|-------------------|--------|--|
|                   |                   |        | <b>CLASS 6</b>   |
|                   |                   |        | <b>Class 6.1</b>   |
|                   |                   |        | <b>Specific entries</b>  |
| 6.1               |                   | 1544   | ALKALOIDS, SOLID, N.O.S. or ALKALOID SALTS, SOLID, N.O.S.  |
| 6.1               |                   | 1549   | ANTIMONY COMPOUND, INORGANIC, SOLID, N.O.S.  |
| 6.1               |                   | 1556   | ARSENIC COMPOUND, LIQUID, N.O.S. inorganic, including: Arsenates, n.o.s., Arsenites, n.o.s., and Arsenic sulphides, n.o.s. |
| 6.1               |                   | 1557   | ARSENIC COMPOUND, SOLID, N.O.S. inorganic, including: Arsenates, n.o.s., Arsenites, n.o.s., and Arsenic sulphides, n.o.s.  |
| 6.1               |                   | 1564   | BARIUM COMPOUND, N.O.S.  |
| 6.1               |                   | 1566   | BERYLLIUM COMPOUND, N.O.S.   |
| 6.1               |                   | 1583   | CHLOROPICRIN MIXTURE, N.O.S.   |
| 6.1               |                   | 1588   | CYANIDES, INORGANIC, SOLID, N.O.S.   |
| 6.1               |                   | 1601   | DISINFECTANT, SOLID, TOXIC, N.O.S.   |
| 6.1               |                   | 1602   | DYE, LIQUID, TOXIC, N.O.S. or DYE INTERMEDIATE, LIQUID, TOXIC, N.O.S.  |
| 6.1               |                   | 1655   | NICOTINE COMPOUND, SOLID, N.O.S. or NICOTINE PREPARATION, SOLID, N.O.S.  |
| 6.1               |                   | 1693   | TEAR GAS SUBSTANCE, LIQUID, N.O.S.   |
| 6.1               |                   | 1707   | THALLIUM COMPOUND, N.O.S.  |
| 6.1               |                   | 1851   | MEDICINE, LIQUID, TOXIC, N.O.S.  |
| 6.1               |                   | 1935   | CYANIDE SOLUTION, N.O.S.   |
| 6.1               |                   | 2024   | MERCURY COMPOUND, LIQUID, N.O.S.   |
| 6.1               |                   | 2025   | MERCURY COMPOUND, SOLID, N.O.S.  |
| 6.1               |                   | 2026   | PHENYLMERCURIC COMPOUND, N.O.S.  |
| 6.1               |                   | 2206   | ISOCYANATES, TOXIC, N.O.S. or ISOCYANATE SOLUTION, TOXIC, N.O.S.   |
| 6.1               |                   | 2291   | LEAD COMPOUND, SOLUBLE, N.O.S.   |
| 6.1               |                   | 2570   | CADMIUM COMPOUND   |
| 6.1               |                   | 2788   | ORGANOTIN COMPOUND, LIQUID, N.O.S.   |
| 6.1               |                   | 2856   | FLUROSILICATES, N.O.S.   |
| 6.1               |                   | 3140   | ALKALOIDS, LIQUID, N.O.S. or ALKALOIDS SALTS, LIQUID, N.O.S.   |
| 6.1               |                   | 3141   | ANTIMONY COMPOUND, INORGANIC, LIQUID, N.O.S.   |
| 6.1               |                   | 3142   | DISINFECTANT, LIQUID, TOXIC, N.O.S.  |
| 6.1               |                   | 3143   | DYE, SOLID, TOXIC, N.O.S. or DYE INTERMEDIATE, SOLID, TOXIC, N.O.S.  |
| 6.1               |                   | 3144   | NICOTINE COMPOUND, LIQUID, N.O.S. or NICOTINE PREPARATION, LIQUID, N.O.S.  |
| 6.1               |                   | 3146   | ORGANOTIN COMPOUND, SOLID, N.O.S.  |
| 6.1               |                   | 3249   | MEDICINE, SOLID, TOXIC, N.O.S.   |
| 6.1               |                   | 3276   | NITRILES, TOXIC, LIQUID, N.O.S.  |
| 6.1               |                   | 3278   | ORGANOPHOSPHORUS COMPOUND, TOXIC, LIQUID, N.O.S.   |
| 6.1               |                   | 3280   | ORGANOARSENIC COMPOUND, LIQUID, N.O.S.   |
| 6.1               |                   | 3281   | METAL CARBONYLS, LIQUID, N.O.S. with LC <sub>50</sub>  |
| 6.1               |                   | 3282   | ORGANOMETALLIC COMPOUND, TOXIC, LIQUID, N.O.S. with LC <sub>50</sub>   |
| 6.1               |                   | 3283   | SELENIUM COMPOUND, SOLID, N.O.S. with LC <sub>50</sub>   |
| 6.1               |                   | 3284   | TELLURIUM COMPOUND, N.O.S. with LC <sub>50</sub>   |
| 6.1               |                   | 3285   | VANADIUM COMPOUND, N.O.S.  |
| 6.1               |                   | 3439   | NITRILES, TOXIC, SOLID, N.O.S.   |
| 6.1               |                   | 3440   | SELENIUM COMPOUND, LIQUID, N.O.S.  |
| 6.1               |                   | 3448   | TEAR GAS SUBSTANCE, SOLID, N.O.S.  |
| 6.1               |                   | 3464   | ORGANOPHOSPHORUS COMPOUND, TOXIC, SOLID, N.O.S.  |
| 6.1               |                   | 3465   | ORGANOARSENIC COMPOUND, SOLID, N.O.S.  |
| 6.1               |                   | 3466   | METAL CARBONYLS, SOLID, N.O.S.   |
| 6.1               |                   | 3467   | ORGANOMETALLIC COMPOUND, TOXIC, SOLID, N.O.S.  |
| 6.1               | 3                 | 3071   | MERCAPTANS, LIQUID, TOXIC, FLAMMABLE, N.O.S. or MERCAPTAN MIXTURE, LIQUID, TOXIC, FLAMMABLE, N.O.S.                        |
| 6.1               | 3                 | 3080   | ISOCYANATES, TOXIC, FLAMMABLE, N.O.S. or ISOCYANATE SOLUTION, TOXIC, FLAMMABLE, N.O.S.                                     |
| 6.1               | 3                 | 3275   | NITRILES, TOXIC, FLAMMABLE, N.O.S.   |
| 6.1               | 3                 | 3279   | ORGANOPHOSPHORUS COMPOUND, TOXIC, FLAMMABLE, N.O.S.  |
| 6.1               | 3 + 8             | 2742   | CHLOROFORMATES, TOXIC, CORROSIVE, FLAMMABLE, N.O.S.  |

Appendix A – List of generic and N.O.S. proper shipping names

| Class or division                   | Subsidiary hazard | UN No. | Proper shipping name   |
|-------------------------------------|-------------------|--------|--|
| <b>CLASS 6 (continued)</b>          |                   |        |  |
| <b>Class 6.1 (continued)</b>        |                   |        |  |
| <b>Specific entries (continued)</b> |                   |        |  |
| 6.1                                 | 3 + 8             | 3362   | CHLOROSILANES, TOXIC, CORROSIVE, FLAMMABLE, N.O.S.   |
| 6.1                                 | 8                 | 3277   | CHLOROFORMATES, TOXIC, CORROSIVE, N.O.S.   |
| 6.1                                 | 8                 | 3361   | CHLOROSILANES, TOXIC, CORROSIVE, N.O.S.  |
| <b>Pesticides</b>                   |                   |        |  |
| <i>(a) Solid</i>                    |                   |        |  |
| 6.1                                 |                   | 2588   | PESTICIDE, SOLID, TOXIC, N.O.S.  |
| 6.1                                 |                   | 2757   | CARBAMATE PESTICIDE, SOLID, TOXIC  |
| 6.1                                 |                   | 2759   | ARSENICAL PESTICIDE, SOLID, TOXIC  |
| 6.1                                 |                   | 2761   | ORGANOCHLORINE PESTICIDE, SOLID, TOXIC   |
| 6.1                                 |                   | 2763   | TRIAZINE PESTICIDE, SOLID, TOXIC   |
| 6.1                                 |                   | 2771   | THIOCARBAMATE PESTICIDE, SOLID, TOXIC  |
| 6.1                                 |                   | 2775   | COPPER BASED PESTICIDE, SOLID, TOXIC   |
| 6.1                                 |                   | 2777   | MERCURY BASED PESTICIDE, SOLID, TOXIC  |
| 6.1                                 |                   | 2779   | SUBSTITUTED NITROPHENOL PESTICIDE, SOLID, TOXIC  |
| 6.1                                 |                   | 2781   | BIPYRIDILIUM PESTICIDE, SOLID, TOXIC   |
| 6.1                                 |                   | 2783   | ORGANOPHOSPHORUS PESTICIDE, SOLID, TOXIC   |
| 6.1                                 |                   | 2786   | ORGANOTIN PESTICIDE, SOLID, TOXIC  |
| 6.1                                 |                   | 3027   | COUMARIN DERIVATIVE PESTICIDE, SOLID, TOXIC  |
| 6.1                                 |                   | 3345   | PHENOXYACETIC ACID DERIVATIVE PESTICIDE, SOLID, TOXIC  |
| 6.1                                 |                   | 3349   | PYRETHROID PESTICIDE, SOLID, TOXIC   |
| <i>(b) Liquid</i>                   |                   |        |  |
| 6.1                                 |                   | 2902   | PESTICIDE, LIQUID TOXIC, N.O.S.  |
| 6.1                                 |                   | 2992   | CARBAMATE PESTICIDE, LIQUID, TOXIC   |
| 6.1                                 |                   | 2994   | ARSENICAL PESTICIDE, LIQUID, TOXIC   |
| 6.1                                 |                   | 2996   | ORGANOCHLORINE PESTICIDE, LIQUID, TOXIC  |
| 6.1                                 |                   | 2998   | TRIAZINE PESTICIDE, LIQUID, TOXIC  |
| 6.1                                 |                   | 3006   | THIOCARBAMATE PESTICIDE, LIQUID, TOXIC   |
| 6.1                                 |                   | 3010   | COPPER BASED PESTICIDE, LIQUID, TOXIC  |
| 6.1                                 |                   | 3012   | MERCURY BASED PESTICIDE, LIQUID, TOXIC   |
| 6.1                                 |                   | 3014   | SUBSTITUTED NITROPHENOL PESTICIDE, LIQUID, TOXIC   |
| 6.1                                 |                   | 3016   | BIPYRIDILIUM PESTICIDE, LIQUID, TOXIC  |
| 6.1                                 |                   | 3018   | ORGANOPHOSPHORUS PESTICIDE, LIQUID, TOXIC  |
| 6.1                                 |                   | 3020   | ORGANOTIN PESTICIDE, LIQUID, TOXIC   |
| 6.1                                 |                   | 3026   | COUMARIN DERIVATIVE PESTICIDE, LIQUID, TOXIC   |
| 6.1                                 |                   | 3348   | PHENOXYACETIC ACID DERIVATIVE PESTICIDE, LIQUID, TOXIC   |
| 6.1                                 |                   | 3352   | PYRETHROID PESTICIDE, LIQUID, TOXIC  |
| 6.1                                 | 3                 | 2903   | PESTICIDE, LIQUID, TOXIC, FLAMMABLE, N.O.S., flashpoint $\geq 23^{\circ}\text{C}$                      |
| 6.1                                 | 3                 | 2991   | CARBAMATE PESTICIDE, LIQUID, TOXIC, FLAMMABLE, flashpoint $\geq 23^{\circ}\text{C}$                    |
| 6.1                                 | 3                 | 2993   | ARSENICAL PESTICIDE, LIQUID, TOXIC, FLAMMABLE flashpoint $\geq 23^{\circ}\text{C}$                     |
| 6.1                                 | 3                 | 2995   | ORGANOCHLORINE PESTICIDE, LIQUID, TOXIC, FLAMMABLE flashpoint $\geq 23^{\circ}\text{C}$                |
| 6.1                                 | 3                 | 2997   | TRIAZINE PESTICIDE, LIQUID, TOXIC, FLAMMABLE, flashpoint $\geq 23^{\circ}\text{C}$                     |
| 6.1                                 | 3                 | 3005   | THIOCARBAMATE PESTICIDE, LIQUID, TOXIC, FLAMMABLE flashpoint $\geq 23^{\circ}\text{C}$                 |
| 6.1                                 | 3                 | 3009   | COPPER BASED PESTICIDE, LIQUID, TOXIC, FLAMMABLE flashpoint $\geq 23^{\circ}\text{C}$                  |
| 6.1                                 | 3                 | 3011   | MERCURY BASED PESTICIDE, LIQUID, TOXIC, FLAMMABLE flashpoint $\geq 23^{\circ}\text{C}$                 |
| 6.1                                 | 3                 | 3013   | SUBSTITUTED NITROPHENOL PESTICIDE, LIQUID, TOXIC, FLAMMABLE flashpoint $\geq 23^{\circ}\text{C}$       |
| 6.1                                 | 3                 | 3015   | BIPYRIDILIUM PESTICIDE, LIQUID, TOXIC, FLAMMABLE flashpoint $\geq 23^{\circ}\text{C}$                  |
| 6.1                                 | 3                 | 3017   | ORGANOPHOSPHORUS PESTICIDE, LIQUID, TOXIC, FLAMMABLE flashpoint $\geq 23^{\circ}\text{C}$              |
| 6.1                                 | 3                 | 3019   | ORGANOTIN PESTICIDE, LIQUID, TOXIC, FLAMMABLE flashpoint $\geq 23^{\circ}\text{C}$                     |
| 6.1                                 | 3                 | 3025   | COUMARIN DERIVATIVE PESTICIDE, LIQUID, TOXIC, FLAMMABLE flashpoint $\geq 23^{\circ}\text{C}$           |
| 6.1                                 | 3                 | 3347   | PHENOXYACETIC ACID DERIVATIVE PESTICIDE, LIQUID, TOXIC, FLAMMABLE flashpoint $\geq 23^{\circ}\text{C}$ |
| 6.1                                 | 3                 | 3351   | PYRETHROID PESTICIDE, LIQUID, TOXIC, FLAMMABLE flashpoint $\geq 23^{\circ}\text{C}$                    |

Appendices

| Class or division | Subsidiary hazard | UN No. | Proper shipping name  |
|-------------------|-------------------|--------|---|
|                   |                   |        | <b>CLASS 6 (continued)</b>  |
|                   |                   |        | <b>Class 6.1 (continued)</b>  |
|                   |                   |        | <b>General entries</b>  |
| 6.1               |                   | 2810   | TOXIC LIQUID, ORGANIC, N.O.S.   |
| 6.1               |                   | 2811   | TOXIC SOLID, ORGANIC, N.O.S.  |
| 6.1               |                   | 3172   | TOXINS, EXTRACTED FROM LIVING SOURCES, LIQUID, N.O.S.   |
| 6.1               |                   | 3243   | SOLIDS CONTAINING TOXIC LIQUID, N.O.S.  |
| 6.1               |                   | 3287   | TOXIC LIQUID, INORGANIC, N.O.S.   |
| 6.1               |                   | 3288   | TOXIC SOLID, INORGANIC, N.O.S.  |
| 6.1               |                   | 3315   | CHEMICAL SAMPLE, TOXIC  |
| 6.1               |                   | 3381   | TOXIC BY INHALATION LIQUID, N.O.S. with an LC <sub>50</sub> lower than or equal to 200 mL/m <sup>3</sup> and saturated vapour concentration greater than or equal to 500 LC <sub>50</sub>                             |
| 6.1               |                   | 3382   | TOXIC BY INHALATION LIQUID, N.O.S. with an LC <sub>50</sub> lower than or equal to 1,000 mL/m <sup>3</sup> and saturated vapour concentration greater than or equal to 10 LC <sub>50</sub>                            |
| 6.1               |                   | 3462   | TOXINS, EXTRACTED FROM LIVING SOURCES, SOLID, N.O.S.  |
| 6.1               | See 2.0.6.6       | 3546   | ARTICLES CONTAINING TOXIC SUBSTANCE, N.O.S.   |
| 6.1               | 3                 | 2929   | TOXIC LIQUID, FLAMMABLE, ORGANIC, N.O.S.  |
| 6.1               | 3                 | 3383   | TOXIC BY INHALATION LIQUID, FLAMMABLE, N.O.S. with an LC <sub>50</sub> lower than or equal to 200 mL/m <sup>3</sup> and saturated vapour concentration greater than or equal to 500 LC <sub>50</sub>                  |
| 6.1               | 3                 | 3384   | TOXIC BY INHALATION LIQUID, FLAMMABLE, N.O.S. with an LC <sub>50</sub> lower than or equal to 1,000 mL/m <sup>3</sup> and saturated vapour concentration greater than or equal to 10 LC <sub>50</sub>                 |
| 6.1               | 3 + 8             | 3488   | TOXIC BY INHALATION LIQUID, FLAMMABLE, CORROSIVE, N.O.S. with an LC <sub>50</sub> lower than or equal to 200 mL/m <sup>3</sup> and saturated vapour concentration greater than or equal to 500 LC <sub>50</sub>       |
| 6.1               | 3 + 8             | 3489   | TOXIC BY INHALATION LIQUID, FLAMMABLE, CORROSIVE, N.O.S. with an LC <sub>50</sub> lower than or equal to 1,000 mL/m <sup>3</sup> and saturated vapour concentration greater than or equal to 10 LC <sub>50</sub>      |
| 6.1               | 4.1               | 2930   | TOXIC SOLID, FLAMMABLE, ORGANIC, N.O.S.   |
| 6.1               | 4.1               | 3535   | TOXIC SOLID, FLAMMABLE, INORGANIC, N.O.S.   |
| 6.1               | 4.2               | 3124   | TOXIC SOLID, SELF-HEATING, N.O.S.   |
| 6.1               | 4.3               | 3123   | TOXIC LIQUID, WATER-REACTIVE, N.O.S.  |
| 6.1               | 4.3               | 3125   | TOXIC SOLID, WATER-REACTIVE, N.O.S.   |
| 6.1               | 4.3               | 3385   | TOXIC BY INHALATION LIQUID, WATER-REACTIVE, N.O.S. with an LC <sub>50</sub> lower than or equal to 200 mL/m <sup>3</sup> and saturated vapour concentration greater than or equal to 500 LC <sub>50</sub>             |
| 6.1               | 4.3               | 3386   | TOXIC BY INHALATION LIQUID, WATER-REACTIVE, N.O.S. with an LC <sub>50</sub> lower than or equal to 1,000 mL/m <sup>3</sup> and saturated vapour concentration greater than or equal to 10 LC <sub>50</sub>            |
| 6.1               | 4.3 + 3           | 3490   | TOXIC BY INHALATION LIQUID, WATER-REACTIVE, FLAMMABLE, N.O.S. with an LC <sub>50</sub> lower than or equal to 200 mL/m <sup>3</sup> and saturated vapour concentration greater than or equal to 500 LC <sub>50</sub>  |
| 6.1               | 4.3 + 3           | 3491   | TOXIC BY INHALATION LIQUID, WATER-REACTIVE, FLAMMABLE, N.O.S. with an LC <sub>50</sub> lower than or equal to 1,000 mL/m <sup>3</sup> and saturated vapour concentration greater than or equal to 10 LC <sub>50</sub> |
| 6.1               | 5.1               | 3122   | TOXIC LIQUID, OXIDIZING, N.O.S.   |
| 6.1               | 5.1               | 3086   | TOXIC SOLID, OXIDIZING, N.O.S.  |
| 6.1               | 5.1               | 3387   | TOXIC BY INHALATION LIQUID, OXIDIZING, N.O.S. with an LC <sub>50</sub> lower than or equal to 200 mL/m <sup>3</sup> and saturated vapour concentration greater than or equal to 500 LC <sub>50</sub>                  |
| 6.1               | 5.1               | 3388   | TOXIC BY INHALATION LIQUID, OXIDIZING, N.O.S. with an LC <sub>50</sub> lower than or equal to 1,000 mL/m <sup>3</sup> and saturated vapour concentration greater than or equal to 10 LC <sub>50</sub>                 |
| 6.1               | 8                 | 2927   | TOXIC LIQUID, CORROSIVE, ORGANIC, N.O.S.  |
| 6.1               | 8                 | 2928   | TOXIC SOLID, CORROSIVE, ORGANIC, N.O.S.   |
| 6.1               | 8                 | 3289   | TOXIC LIQUID, CORROSIVE, INORGANIC, N.O.S.  |
| 6.1               | 8                 | 3290   | TOXIC SOLID, CORROSIVE, INORGANIC, N.O.S.   |
| 6.1               | 8                 | 3389   | TOXIC BY INHALATION LIQUID, CORROSIVE, N.O.S. with an LC <sub>50</sub> lower than or equal to 200 mL/m <sup>3</sup> and saturated vapour concentration greater than or equal to 500 LC <sub>50</sub>                  |
| 6.1               | 8                 | 3390   | TOXIC BY INHALATION LIQUID, CORROSIVE, N.O.S. with an LC <sub>50</sub> lower than or equal to 1,000 mL/m <sup>3</sup> and saturated vapour concentration greater than or equal to 10 LC <sub>50</sub>                 |

Appendix A – List of generic and N.O.S. proper shipping names

| Class or division | Subsidiary hazard | UN No. | Proper shipping name  |
|-------------------|-------------------|--------|---|
|                   |                   |        | <b>CLASS 6 (continued)</b>  |
|                   |                   |        | <b>Class 6.2</b>  |
|                   |                   |        | <b>Specific entries</b>   |
| 6.2               |                   | 3291   | CLINICAL WASTE, UNSPECIFIED, N.O.S. or (BIO)MEDICAL WASTE, N.O.S. or REGULATED MEDICAL WASTE, N.O.S.              |
| 6.2               |                   | 3373   | BIOLOGICAL SUBSTANCE, CATEGORY B  |
| 6.2               |                   | 3549   | MEDICAL WASTE, CATEGORY A, AFFECTING HUMANS, solid or<br>MEDICAL WASTE, CATEGORY A, AFFECTING ANIMALS only, solid |
|                   |                   |        | <b>General entries</b>  |
| 6.2               |                   | 2814   | INFECTIOUS SUBSTANCE, AFFECTING HUMANS  |
| 6.2               |                   | 2900   | INFECTIOUS SUBSTANCE, AFFECTING ANIMALS only  |

Appendices

| Class or division | Subsidiary hazard | UN No. | Proper shipping name   |
|-------------------|-------------------|--------|--|
|                   |                   |        | <b>CLASS 7</b>   |
|                   |                   |        | <b>General entries</b>   |
| 7                 |                   | 2908   | RADIOACTIVE MATERIAL, EXCEPTED PACKAGE – EMPTY PACKAGING   |
| 7                 |                   | 2909   | RADIOACTIVE MATERIAL, EXCEPTED PACKAGE – ARTICLES MANUFACTURED FROM NATURAL URANIUM or DEPLETED URANIUM or NATURAL THORIUM |
| 7                 |                   | 2910   | RADIOACTIVE MATERIAL, EXCEPTED PACKAGE – LIMITED QUANTITY OF MATERIAL  |
| 7                 |                   | 2911   | RADIOACTIVE MATERIAL, EXCEPTED PACKAGE – INSTRUMENTS or ARTICLES   |
| 7                 |                   | 2912   | RADIOACTIVE MATERIAL, LOW SPECIFIC ACTIVITY (LSA-I) non fissile or fissile-excepted  |
| 7                 |                   | 2913   | RADIOACTIVE MATERIAL, SURFACE CONTAMINATED OBJECTS (SCO-I, SCO-II or SCO-III) non fissile or fissile-excepted              |
| 7                 |                   | 2915   | RADIOACTIVE MATERIAL, TYPE A PACKAGE, non-special form, non fissile or fissile-excepted                                    |
| 7                 |                   | 2916   | RADIOACTIVE MATERIAL, TYPE B(U) PACKAGE non fissile or fissile-excepted  |
| 7                 |                   | 2917   | RADIOACTIVE MATERIAL, TYPE B(M) PACKAGE non fissile or fissile-excepted  |
| 7                 |                   | 2919   | RADIOACTIVE MATERIAL, TRANSPORTED UNDER SPECIAL ARRANGEMENT non fissile or fissile-excepted                                |
| 7                 |                   | 3321   | RADIOACTIVE MATERIAL, LOW SPECIFIC ACTIVITY (LSA-II), non fissile or fissile-excepted                                      |
| 7                 |                   | 3322   | RADIOACTIVE MATERIAL, LOW SPECIFIC ACTIVITY (LSA-III), non fissile or fissile-excepted                                     |
| 7                 |                   | 3323   | RADIOACTIVE MATERIAL, TYPE C PACKAGE non fissile or fissile-excepted   |
| 7                 |                   | 3324   | RADIOACTIVE MATERIAL, LOW SPECIFIC ACTIVITY (LSA-II), FISSILE  |
| 7                 |                   | 3325   | RADIOACTIVE MATERIAL, LOW SPECIFIC ACTIVITY (LSA-III), FISSILE   |
| 7                 |                   | 3326   | RADIOACTIVE MATERIAL, SURFACE CONTAMINATED OBJECTS (SCO-I or SCO-II), FISSILE  |
| 7                 |                   | 3327   | RADIOACTIVE MATERIAL, TYPE A PACKAGE, FISSILE non-special form   |
| 7                 |                   | 3328   | RADIOACTIVE MATERIAL, TYPE B(U) PACKAGE, FISSILE   |
| 7                 |                   | 3329   | RADIOACTIVE MATERIAL, TYPE B(M) PACKAGE, FISSILE   |
| 7                 |                   | 3330   | RADIOACTIVE MATERIAL, TYPE C PACKAGE, FISSILE  |
| 7                 |                   | 3331   | RADIOACTIVE MATERIAL, TRANSPORTED UNDER SPECIAL ARRANGEMENT, FISSILE   |
| 7                 |                   | 3332   | RADIOACTIVE MATERIAL, TYPE A PACKAGE, SPECIAL FORM non fissile or fissile-excepted   |
| 7                 |                   | 3333   | RADIOACTIVE MATERIAL, TYPE A PACKAGE, SPECIAL FORM, FISSILE  |

Appendix A – List of generic and N.O.S. proper shipping names

| Class or division       | Subsidiary hazard | UN No. | Proper shipping name   |
|-------------------------|-------------------|--------|--|
| <b>CLASS 8</b>          |                   |        |  |
| <b>Specific entries</b> |                   |        |  |
| 8                       |                   | 1719   | CAUSTIC ALKALI LIQUID, N.O.S.  |
| 8                       |                   | 1740   | HYDROGENDIFLUORIDES, SOLID, N.O.S.   |
| 8                       |                   | 1903   | DISINFECTANT, LIQUID, CORROSIVE, N.O.S.  |
| 8                       |                   | 2430   | ALKYLPHENOLS, SOLID, N.O.S. (including C <sub>2</sub> -C <sub>12</sub> homologues)               |
| 8                       |                   | 2693   | BISULPHITES, AQUEOUS SOLUTION, N.O.S.  |
| 8                       |                   | 2735   | AMINES, LIQUID, CORROSIVE, N.O.S. or POLYAMINES, LIQUID, CORROSIVE, N.O.S.                       |
| 8                       |                   | 2801   | DYE, LIQUID, CORROSIVE, N.O.S. or DYE INTERMEDIATE, LIQUID, CORROSIVE, N.O.S.                    |
| 8                       |                   | 2837   | BISULPHATES, AQUEOUS SOLUTION  |
| 8                       |                   | 2987   | CHLOROSILANES, CORROSIVE, N.O.S.   |
| 8                       |                   | 3145   | ALKYLPHENOLS, LIQUID, N.O.S. (including C <sub>2</sub> -C <sub>12</sub> homologues)              |
| 8                       |                   | 3147   | DYE, SOLID, CORROSIVE, N.O.S. or DYE INTERMEDIATE, SOLID, CORROSIVE, N.O.S.                      |
| 8                       |                   | 3259   | AMINES, SOLID, CORROSIVE, N.O.S. or POLYAMINES, SOLID, CORROSIVE, N.O.S.                         |
| 8                       | 3                 | 2734   | AMINES, LIQUID, CORROSIVE, FLAMMABLE, N.O.S. or POLYAMINES, LIQUID, CORROSIVE, FLAMMABLE, N.O.S. |
| 8                       | 3                 | 2986   | CHLOROSILANES, CORROSIVE, FLAMMABLE, N.O.S.  |
| 8                       | 6.1               | 3471   | HYDROGENDIFLUORIDES SOLUTION, N.O.S.   |
| <b>General entries</b>  |                   |        |  |
| 8                       |                   | 1759   | CORROSIVE SOLID, N.O.S.  |
| 8                       |                   | 1760   | CORROSIVE LIQUID, N.O.S.   |
| 8                       |                   | 3244   | SOLIDS CONTAINING CORROSIVE LIQUID, N.O.S.   |
| 8                       |                   | 3260   | CORROSIVE SOLID, ACIDIC, INORGANIC, N.O.S.   |
| 8                       |                   | 3261   | CORROSIVE SOLID, ACIDIC, ORGANIC, N.O.S.   |
| 8                       |                   | 3262   | CORROSIVE SOLID, BASIC, INORGANIC, N.O.S.  |
| 8                       |                   | 3263   | CORROSIVE SOLID, BASIC, ORGANIC, N.O.S.  |
| 8                       |                   | 3264   | CORROSIVE LIQUID, ACIDIC, INORGANIC, N.O.S.  |
| 8                       |                   | 3265   | CORROSIVE LIQUID, ACIDIC, ORGANIC, N.O.S.  |
| 8                       |                   | 3266   | CORROSIVE LIQUID, BASIC, INORGANIC, N.O.S.   |
| 8                       |                   | 3267   | CORROSIVE LIQUID, BASIC, ORGANIC, N.O.S.   |
| 8                       | See 2.0.6.6       | 3547   | ARTICLES CONTAINING CORROSIVE SUBSTANCE, N.O.S.  |
| 8                       | 3                 | 2920   | CORROSIVE LIQUID, FLAMMABLE, N.O.S.  |
| 8                       | 4.1               | 2921   | CORROSIVE SOLID, FLAMMABLE, N.O.S.   |
| 8                       | 4.2               | 3095   | CORROSIVE SOLID, SELF-HEATING, N.O.S.  |
| 8                       | 4.2               | 3301   | CORROSIVE LIQUID, SELF-HEATING, N.O.S.   |
| 8                       | 4.3               | 3094   | CORROSIVE LIQUID, WATER-REACTIVE, N.O.S.   |
| 8                       | 4.3               | 3096   | CORROSIVE SOLID, WATER-REACTIVE, N.O.S.  |
| 8                       | 5.1               | 3084   | CORROSIVE SOLID, OXIDIZING, N.O.S.   |
| 8                       | 5.1               | 3093   | CORROSIVE LIQUID, OXIDIZING, N.O.S.  |
| 8                       | 6.1               | 2922   | CORROSIVE LIQUID, TOXIC, N.O.S.  |
| 8                       | 6.1               | 2923   | CORROSIVE SOLID, TOXIC, N.O.S.   |



Appendices

| Class or division | Subsidiary hazard | UN No. | Proper shipping name   |
|-------------------|-------------------|--------|--|
|                   |                   |        | <b>CLASS 9</b>   |
|                   |                   |        | <b>General entries</b>   |
| 9                 |                   | 3077   | ENVIRONMENTALLY HAZARDOUS SUBSTANCE, SOLID, N.O.S.   |
| 9                 |                   | 3082   | ENVIRONMENTALLY HAZARDOUS SUBSTANCE, LIQUID, N.O.S.  |
| 9                 |                   | 3245   | GENETICALLY MODIFIED MICROORGANISMS or GENETICALLY MODIFIED ORGANISMS  |
| 9                 |                   | 3257   | ELEVATED TEMPERATURE LIQUID, N.O.S. at or above 100°C and below its flashpoint (including molten metals, molten salts, etc.) |
| 9                 |                   | 3258   | ELEVATED TEMPERATURE SOLID, N.O.S., at or above 240°C  |
| see SP960         |                   | 3334   | AVIATION REGULATED LIQUID, N.O.S.  |
| see SP960         |                   | 3335   | AVIATION REGULATED SOLID, N.O.S.   |
| 9                 | See 2.0.6.6       | 3548   | ARTICLES CONTAINING MISCELLANEOUS DANGEROUS GOODS, N.O.S.  |

# Appendix B

## Glossary of terms

**Note:** The provisions of this appendix are not mandatory.

**Caution:** The explanations in this glossary are for information only and are not to be used for purposes of hazard classification.

### Ammunition

Generic term related mainly to articles of military application consisting of all kind of bombs, grenades, rockets, mines, projectiles and other similar devices or contrivances.

### AMMUNITION, ILLUMINATING with or without burster, expelling charge or propelling charge

Ammunition designed to produce a single source of intense light for lighting up an area. The term includes illuminating cartridges, grenades and projectiles; and illuminating and target identification bombs. The term excludes the following articles which are listed separately: CARTRIDGES, SIGNAL; SIGNAL DEVICES, HAND; SIGNALS, DISTRESS; FLARES, AERIAL and FLARES, SURFACE.

### AMMUNITION, INCENDIARY

Ammunition containing incendiary substances which may be a solid, liquid or gel including white phosphorus. Except when the composition is an explosive *per se*, it also contains one or more of the following: a propelling charge with primer and igniter charge; a fuze with burster or expelling charge. The term includes:

AMMUNITION, INCENDIARY, liquid or gel, with burster, expelling charge or propelling charge;

AMMUNITION, INCENDIARY with or without burster, expelling charge or propelling charge;

AMMUNITION, INCENDIARY, WHITE PHOSPHORUS with burster, expelling charge or propelling charge.

### AMMUNITION, PRACTICE

Ammunition without a main bursting charge, containing a burster or expelling charge. Normally it also contains a fuze and a propelling charge. The term excludes the following articles which are listed separately: GRENADES, PRACTICE.

### AMMUNITION, PROOF

Ammunition containing pyrotechnic substances, used to test the performance or strength of new ammunition, weapon component or assemblies.

### AMMUNITION, SMOKE

Ammunition containing a smoke-producing substance such as chlorosulphonic acid mixture, titanium tetrachloride or white phosphorus; or smoke-producing pyrotechnic composition based on hexachloroethane or red phosphorus. Except when the substance is an explosive *per se*, the ammunition also contains one or more of the following: a propelling charge with primer and igniter charge; a fuze with burster or expelling charge. The term includes grenades, smoke but excludes SIGNALS, SMOKE which are listed separately. The term includes:

AMMUNITION, SMOKE with or without burster, expelling charge or propelling charge;

AMMUNITION, SMOKE, WHITE PHOSPHORUS with burster, expelling charge or propelling charge.

Appendices

|   |   |
|---|---|
| <b>AMMUNITION, TEAR-PRODUCING with burster, expelling charge or propelling charge</b> | Ammunition containing tear-producing substance. It also contains one or more of the following: a pyrotechnic substance; a propelling charge with primer and igniter charge; a fuze with burster or expelling charge.  |
| <b>AMMUNITION, TOXIC with burster, expelling charge or propelling charge</b>          | Ammunition containing toxic agent. It also contains one or more of the following: a pyrotechnic substance; a propelling charge with primer and igniter charge; a fuze with burster or expelling charge.   |
| <b>ARTICLES, EXPLOSIVE, EXTREMELY INSENSITIVE (ARTICLES, EEI)</b>                     | Articles that predominantly contain extremely insensitive substances and which demonstrate a negligible probability of accidental initiation or propagation (under normal conditions of transport) and which have passed test series 7.   |
| <b>ARTICLES, PYROPHORIC</b>   | Articles which contain a pyrophoric substance (capable of spontaneous ignition when exposed to air) and an explosive substance or component. The term excludes articles containing white phosphorus.  |
| <b>ARTICLES, PYROTECHNIC for technical purposes</b>                                   | Articles which contain pyrotechnic substances and are used for technical purposes such as heat generation, gas generation, theatrical effects, etc. The term excludes the following articles which are listed separately: all ammunition; CARTRIDGES, SIGNAL; CUTTERS, CABLE, EXPLOSIVE; FIREWORKS; FLARES, AERIAL; FLARES, SURFACE; RELEASE DEVICES, EXPLOSIVE; RIVETS, EXPLOSIVE; SIGNAL DEVICES, HAND; SIGNALS, DISTRESS; SIGNALS, RAILWAY TRACK, EXPLOSIVE; SIGNALS, SMOKE. |
| <b>Auxiliary explosive component, isolated</b>  | An "isolated auxiliary explosive component" is a small device that explosively performs an operation related to the article's functioning, other than its main explosive load's performance. Functioning of the component does not cause any reaction of the main explosive loads contained within the article.   |
| <b>BLACK POWDER (GUNPOWDER)</b>   | Substance consisting of an intimate mixture of charcoal or other carbon and either potassium nitrate or sodium nitrate, with or without sulphur. It may be meal, granular, compressed or pelletized.  |
| <b>Bombs</b>  | Explosive articles which are dropped from aircraft. They may contain a flammable liquid with bursting charge, a photo-flash composition or a bursting charge. The term excludes torpedoes (aerial) and includes:<br><ul style="list-style-type: none"> <li>BOMBS, PHOTO-FLASH;</li> <li>BOMBS with bursting charge;</li> <li>BOMBS WITH FLAMMABLE LIQUID with bursting charge.</li> </ul>   |
| <b>BOOSTERS</b>   | Articles consisting of a charge of detonating explosive with or without means of initiation. They are used to increase the initiating power of detonators or detonating cord.   |
| <b>BURSTERS, explosive</b>  | Articles consisting of a small charge of explosive used to open projectiles or other ammunition in order to disperse their contents.  |
| <b>Cartridges, blank</b>  | Articles which consist of a cartridge case with a centre or rim fire primer and a confined charge of smokeless or black powder but no projectile. Used for training, saluting or in starter pistols, tools, etc.  |
| <b>CARTRIDGES, FLASH</b>  | Articles consisting of a casing, a primer and flash powder, all assembled in one piece ready for firing.  |

|  |  |
|--|--|
| <b>Cartridges for Weapons</b>                    | <p>.1 Fixed (assembled) or semi-fixed (partially-assembled) ammunition designed to be fired from weapons. Each cartridge includes all the components necessary to function the weapon once. The proper shipping name shall be used for small arms cartridges that cannot be described as “cartridges, small arms”. Separate loading ammunition is included under this proper shipping name when the propelling charge and projectile are packed together (see also “Cartridges, blank”).</p> <p>.2 Incendiary, smoke, toxic and tear-producing cartridges are described in this Glossary under AMMUNITION, INCENDIARY etc.</p> |
| <b>CARTRIDGES FOR WEAPONS, INERT PROJECTILE</b>  | <p>Ammunition consisting of a projectile without bursting charge but with a propelling charge. The presence of a tracer can be disregarded for classification purposes provided that the predominant hazard is that of the propelling charge.</p>  |
| <b>CARTRIDGES, OIL WELL</b>                      | <p>Articles consisting of a casing of thin fibre, metal or other material containing only propellant which projects a hardened projectile. The term excludes the following articles which are listed separately: CHARGES, SHAPED.</p>  |
| <b>CARTRIDGES, POWER DEVICE</b>                  | <p>Articles designed to accomplish mechanical actions. They consist of a casing with a charge of deflagrating explosive and a means of ignition. The gaseous products of the deflagration produce inflation, or linear or rotary motion, or activate diaphragms, valves or switches or project fastening devices or extinguishing agents.</p>  |
| <b>CARTRIDGES, SIGNAL</b>                        | <p>Articles designed to fire coloured flares or other signals from signal pistols, etc.</p>  |
| <b>CARTRIDGES, SMALL ARMS</b>                    | <p>Ammunition consisting of a cartridge case fitted with a centre or rim fire primer and containing both a propelling charge and a solid projectile. They are designed to be fired in weapons of calibre not larger than 19.1 mm. Shotgun cartridges of any calibre are included in this description. The term excludes: CARTRIDGES, SMALL ARMS, BLANK listed separately in the Dangerous Goods List; and some small arms cartridges which are listed under CARTRIDGES FOR WEAPONS, INERT PROJECTILE.</p>  |
| <b>CASES, CARTRIDGE, EMPTY, WITH PRIMER</b>      | <p>Articles consisting of a cartridge case made from metal, plastics or other non-flammable material, in which the only explosive component is the primer.</p>   |
| <b>CASES, COMBUSTIBLE, EMPTY, WITHOUT PRIMER</b> | <p>Articles consisting of cartridge cases made partly or entirely from nitrocellulose.</p>   |
| <b>Charges, bursting</b>                         | <p>Articles consisting of a charge of detonating explosive such as hexolite, octolite or plastics bonded explosive designed to produce effect by blast or fragmentation.</p>   |
| <b>CHARGES, DEMOLITION</b>                       | <p>Articles containing a charge of a detonating explosive in a casing of fibreboard, plastics, metal or other material. The term excludes the following articles which are listed separately: bombs, mines, etc.</p>   |
| <b>CHARGES, DEPTH</b>                            | <p>Articles consisting of a charge of detonating explosive contained in a drum or projectile. They are designed to detonate under water.</p>   |
| <b>Charges, expelling</b>                        | <p>A charge of deflagrating explosive designed to eject the payload from the parent articles without damage.</p>   |

|   |   |
|---|---|
| CHARGES, EXPLOSIVE, COMMERCIAL without detonator                                  | Articles consisting of a charge of detonating explosive without means of initiation, used for explosive welding, jointing, forming and other metallurgical processes.   |
| CHARGES, PROPELLING   | Articles consisting of a propellant charge in any physical form, with or without a casing, for use as a component of rocket motors or for reducing the drag of projectiles.   |
| CHARGES, PROPELLING FOR CANNON  | Articles consisting of a propellant charge in any physical form, with or without a casing, for use in a cannon.   |
| CHARGES, SHAPED, without detonator  | Articles consisting of a casing containing a charge of detonating explosive with a cavity lined with rigid material, without means of initiation. They are designed to produce a powerful, penetrating jet effect.  |
| CHARGES, SHAPED, FLEXIBLE, LINEAR   | Articles consisting of a V-shaped core of a detonating explosive clad by a flexible metal sheath.   |
| CHARGES, SUPPLEMENTARY, EXPLOSIVE   | Articles consisting of a small removable booster used in the cavity of a projectile between the fuze and the bursting charge.   |
| COMPONENTS, EXPLOSIVE TRAIN, N.O.S.   | Articles containing an explosive designed to transmit the detonation or deflagration within an explosive train.   |
| CONTRIVANCES, WATER-ACTIVATED with burster, expelling charge or propelling charge | Articles whose functioning depends upon physico-chemical reaction of their contents with water.   |
| CORD, DETONATING, flexible  | Article consisting of a core of detonating explosive enclosed in spun fabric, with plastics or other covering unless the spun fabric is sift-proof.   |
| CORD (FUZE), DETONATING, metal clad   | Article consisting of a core of detonating explosive clad by a soft metal tube with or without protective covering. When the core contains a sufficiently small quantity of explosive, the words "MILD EFFECT" are added.   |
| CORD, IGNITER   | Article consisting of textile yarns covered with black powder or another fast-burning pyrotechnic composition and of a flexible protective covering; or it consists of a core of black powder surrounded by a flexible woven fabric. It burns progressively along its length with an external flame and is used to transmit ignition from a device to a charge or primer.   |
| CUTTERS, CABLE, EXPLOSIVE   | Articles consisting of a knife-edged device which is driven by a small charge of deflagrating explosive into an anvil.  |
| DETONATOR ASSEMBLIES, NON-ELECTRIC for blasting                                   | Non-electric detonators assembled with and activated by such means as safety fuse, shock tube, flash tube or detonating cord. They may be of instantaneous design or incorporate delay elements. Detonating relays incorporating detonating cord are included. Other detonating relays are included in "Detonators, non-electric".  |
| Detonators  | Articles consisting of a small metal or plastics tube containing explosives such as lead azide, PETN or combinations of explosives. They are designed to start a detonation train. They may be constructed to detonate instantaneously, or may contain a delay element. The term includes:<br><br><div style="margin-left: 40px;"> <p>DETONATORS FOR AMMUNITION and<br/> DETONATORS for blasting, ELECTRIC, NON-ELECTRIC, and ELECTRONIC programmable.</p> </div> <p>Detonating relays without flexible detonating cord are included.</p> |

|   |  |
|---|--|
| <b>DETONATORS, ELECTRONIC programmable for blasting</b> | Detonators with enhanced safety and security features, utilizing electronic components to transmit a firing signal with validated commands and secure communications. Detonators of this type cannot be initiated by other means.  |
| <b>Entire load and total contents</b>                   | The phrases “entire load” and “total contents” mean such a substantial proportion that the practical hazard shall be assessed by assuming simultaneous explosion of the whole of the explosive content of the load or package.   |
| <b>Explode</b>  | The verb used to indicate those explosive effects capable of endangering life and property through blast, heat and projection of missiles. It encompasses both deflagration and detonation.  |
| <b>Explosion of the total contents</b>                  | The phrase “explosion of the total contents” is used in testing a single article or package or a small stack of articles or packages.  |
| <b>Explosive, blasting</b>                              | Detonating explosive substances used in mining, construction and similar tasks. Blasting explosives are assigned to one of five types. In addition to the ingredients listed, blasting explosives may also contain inert components such as kieselguhr, and minor ingredients such as colouring agents and stabilizers.  |
| <b>EXPLOSIVE, BLASTING, TYPE A</b>                      | Substances consisting of liquid organic nitrates such as nitroglycerin or a mixture of such ingredients with one or more of the following: nitrocellulose; ammonium nitrate or other inorganic nitrates; aromatic nitro-derivatives, or combustible materials, such as wood-meal and aluminium powder. Such explosives shall be in powdery, gelatinous or elastic form.<br><br>The term includes dynamite gelatine, blasting and gelatine dynamites. |
| <b>EXPLOSIVE, BLASTING, TYPE B</b>                      | Substances consisting of (a) a mixture of ammonium nitrate or other inorganic nitrates with an explosive such as trinitrotoluene, with or without other substances such as wood-meal and aluminium powder, or (b) a mixture of ammonium nitrate or other inorganic nitrates with other combustible substances which are not explosive ingredients. Such explosives shall not contain nitroglycerin, similar liquid organic nitrates, or chlorates.   |
| <b>EXPLOSIVE, BLASTING, TYPE C</b>                      | Substances consisting of a mixture of either potassium or sodium chlorate or potassium, sodium or ammonium perchlorate with organic nitro-derivatives or combustible materials such as wood-meal or aluminium powder or a hydrocarbon. Such explosives shall not contain nitroglycerin or similar liquid organic nitrates.   |
| <b>EXPLOSIVE, BLASTING, TYPE D</b>                      | Substances consisting of a mixture of organic nitrated compounds and combustible materials such as hydrocarbons and aluminium powder. Such explosives shall not contain nitroglycerin, similar liquid organic nitrates, chlorates or ammonium nitrate. The term generally includes plastic explosives.   |
| <b>EXPLOSIVE, BLASTING, TYPE E</b>                      | Substances consisting of water as an essential ingredient and high proportions of ammonium nitrate or other oxidizers, some or all of which are in solution. The other constituents may include nitro-derivatives such as trinitrotoluene, hydrocarbons or aluminium powder.<br><br>The term includes explosives, emulsion; explosives slurry and explosives, water gel.   |



|  |  |
|--|--|
| Explosive, deflagrating  | A substance, e.g. propellant, which reacts by deflagration rather than detonation when ignited and used in its normal manner.  |
| Explosive, detonating  | A substance which reacts by detonation rather than deflagration when initiated and used in its normal manner.  |
| Explosive, extremely insensitive substance (EIS)               | A substance which has demonstrated through tests that it is so insensitive that there is very little probability of accidental initiation.   |
| Explosive, primary   | Explosive substance manufactured with a view to producing a practical effect by explosion which is very sensitive to heat, impact or friction and which, even in very small quantities, either detonates or burns very rapidly. It is able to transmit detonation (in the case of initiating explosive) or deflagration to secondary explosives close to it. The main primary explosives are mercury fulminate, lead azide and lead styphnate. |
| Explosive, secondary   | Explosive substance which is relatively insensitive (when compared to primary explosives), which is usually initiated by primary explosives with or without the aid of boosters or supplementary charges. Such an explosive may react as a deflagrating or as a detonating explosive.  |
| <b>■ FIRE SUPPRESSANT DISPERSING DEVICES</b>                   | Articles which contain a pyrotechnic substance, which are intended to disperse a fire-extinguishing agent (or aerosol) when activated, and which do not contain any other dangerous goods.   |
| <b>FIREWORKS</b>   | Pyrotechnic articles designed for entertainment.   |
| Flares   | Articles containing pyrotechnic substances which are designed for use to illuminate, identify, signal or warn. The term includes:<br>FLARES, AERIAL;<br>FLARES, SURFACE.   |
| FLASH POWDER   | Pyrotechnic substance which, when ignited, produces an intense light.  |
| FRACTURING DEVICES, EXPLOSIVE for oil wells, without detonator | Articles consisting of a charge of detonating explosive contained in a casing without means of initiation. They are used to fracture the rock around a drill shaft to assist the flow of crude oil from the rock.  |
| Fuse/Fuze  | Although these two words have a common origin (French fusée, fusil) and are sometimes considered to be different spellings, it is useful to maintain the convention that fuse refers to a cord-like igniting device whereas fuze refers to a device used in ammunition which incorporates mechanical, electrical, chemical or hydrostatic components to initiate a train by deflagration or detonation.  |
| FUSE, IGNITER, tubular, metal clad                             | Article consisting of a metal tube with a core of deflagrating explosive.  |
| FUSE, INSTANTANEOUS, NON-DETONATING (QUICKMATCH)               | Article consisting of cotton yarns impregnated with fine black powder (Quickmatch). It burns with an external flame and is used in ignition trains for fireworks, etc.   |
| FUSE, SAFETY   | Article consisting of a core of fine-grained black powder surrounded by a flexible woven fabric with one or more protective outer coverings. When ignited, it burns at a predetermined rate without any external explosive effect.   |

|                                |  |
|--------------------------------|--|
| <b>Fuzes</b>                   | <p>Articles designed to start a detonation or a deflagration in ammunition. They incorporate mechanical, electrical, chemical or hydrostatic components and generally protective features. The term includes:</p> <p style="padding-left: 20px;">FUZES, DETONATING;</p> <p style="padding-left: 20px;">FUZES, DETONATING with protective features;</p> <p style="padding-left: 20px;">FUZES, IGNITING.</p>   |
| <b>GRENADES, hand or rifle</b> | <p>Articles which are designed to be thrown by hand or to be projected by a rifle. The term includes:</p> <p style="padding-left: 20px;">GRENADES, hand or rifle, with bursting charge;</p> <p style="padding-left: 20px;">GRENADES, PRACTICE, hand or rifle.</p> <p>The term excludes grenades, smoke which are listed under AMMUNITION, SMOKE.</p>   |
| <b>IGNITERS</b>                | <p>Articles containing one or more explosive substances used to start deflagration in an explosive train. They may be actuated chemically, electrically or mechanically. This term excludes the following articles which are listed separately: CORD, IGNITER; FUSE, IGNITER; FUSE, NON-DETONATING; FUZES, IGNITING; LIGHTERS, FUSE; PRIMERS, CAP TYPE; PRIMERS, TUBULAR.</p>  |
| <b>Ignition, means of</b>      | <p>A general term used in connection with the method employed to ignite a deflagrating train of explosive or pyrotechnic substances (for example: a primer for a propelling charge; an igniter for a rocket motor; an igniting fuze).</p>  |
| <b>Initiation, means of</b>    | <ol style="list-style-type: none"> <li>.1 A device intended to cause the detonation of an explosive (for example: detonator; detonator for ammunition; detonating fuze).</li> <li>.2 The term “with its own means of initiation” means that the contrivance has its normal initiating device assembled to it and this device is considered to present a significant risk during transport but not one great enough to be unacceptable. The term does not apply, however, to a contrivance packed together with its means of initiation provided the device is packaged so as to eliminate the risk of causing detonation of the contrivance in the event of accidental functioning of the initiating device. The means of initiating can even be assembled to the contrivance provided there are protective features such that the device is very unlikely to cause detonation of the contrivance in conditions which are associated with transport.</li> <li>.3 For the purposes of classification any means of initiation without two effective protective features shall be regarded as compatibility group B; an article with its own means of initiation, without two effective protective features, would be compatibility group F. On the other hand a means of initiation which itself possesses two effective protective features would be compatibility group D; and an article with a means of initiation which possesses two effective protective features would be compatibility group D or E. Means of initiation adjudged as having two effective protective features shall have been approved by the competent national authority. A common and effective way of achieving the necessary degree of protection is to use a means of initiation which incorporates two or more independent safety features.</li> </ol> |

Appendices

|   |   |
|---|---|
| <b>JET PERFORATING GUNS, CHARGED, oil well, without detonator</b> | Articles consisting of a steel tube or metallic strip, into which are inserted shaped charges connected by detonating cord, without means of initiation.  |
| <b>LIGHTERS, FUSE</b>   | Articles of various design actuated by friction, percussion or electricity and used to ignite safety fuse.  |
| <b>Mass explosion</b>   | Explosion which affects almost the entire load virtually instantaneously.   |
| <b>MINES</b>  | Articles consisting normally of metal or composition receptacles and a bursting charge. They are designed to be operated by the passage of ships, vehicles or personnel. The term includes "Bangalore torpedoes".   |
| <b>OXYGEN GENERATORS, CHEMICAL</b>                                | Oxygen generators, chemical, are devices containing chemicals which upon activation release oxygen as a product of chemical reaction. Chemical oxygen generators are used for the generation of oxygen for respiratory support, e.g. in aircraft, submarines, spacecraft, bomb shelters and breathing apparatus. Oxidizing salts such as chlorates and perchlorates of lithium, sodium and potassium, which are used in chemical oxygen generators, evolve oxygen when heated. These salts are mixed (compounded) with a fuel, usually iron powder, to form a chlorate candle, which produces oxygen by continuous reaction. The fuel is used to generate heat by oxidation. Once the reaction begins, oxygen is released from the hot salt by thermal decomposition (a thermal shield is used around the generator). A portion of the oxygen reacts with the fuel to produce more heat which produces more oxygen, and so on. Initiation of the reaction can be achieved by a percussion device, friction device or electric wire. |
| <b>POWDER CAKE (POWDER PASTE), WETTED</b>                         | Substance consisting of nitrocellulose impregnated with not more than 60% of nitroglycerin or other liquid organic nitrates or a mixture of these.  |
| <b>POWDER, SMOKELESS</b>  | Substance based on nitrocellulose used as propellant. The term includes propellants with a single base (nitrocellulose (NC) alone), those with a double base (such as NC and nitroglycerin (NG)) and those with a triple base (such as NC/NG/nitroguanidine). Cast, pressed or bag-charges of smokeless powder are listed under "CHARGES, PROPELLING" or "CHARGES, PROPELLING FOR CANNON".  |
| <b>PRIMERS, CAP TYPE</b>  | Articles consisting of a metal or plastics cap containing a small amount of primary explosive mixture that is readily ignited by impact. They serve as igniting elements in small arms cartridges, and in percussion primers for propelling charges.  |
| <b>PRIMERS, TUBULAR</b>   | Articles consisting of a primer for ignition and an auxiliary charge of deflagrating explosive such as black powder used to ignite the propelling charge in a cartridge case for cannon, etc.   |
| <b>PROJECTILES</b>  | Articles such as a shell or bullet which are projected from a cannon or other artillery gun, rifle or other small arm. They may be inert, with or without tracer, or may contain a burster or expelling charge or a bursting charge. The term includes:<br><ul style="list-style-type: none"> <li>PROJECTILES, inert, with tracer;</li> <li>PROJECTILES with burster or expelling charge;</li> <li>PROJECTILES with bursting charge.</li> </ul>   |

APPENDIX B

|  |   |
|--|---|
| <b>PROPELLANTS</b>   | Deflagrating explosive used for propulsion or for reducing the drag of projectiles.   |
| <b>PROPELLANTS, LIQUID</b>   | Substances consisting of a deflagrating liquid explosive, used for propulsion.  |
| <b>PROPELLANTS, SOLID</b>  | Substances consisting of a deflagrating solid explosive, used for propulsion.   |
| <b>RELEASE DEVICES, EXPLOSIVE</b>  | Articles consisting of a small charge of explosive with means of initiation. They sever rods or links to release equipment quickly.   |
| <b>ROCKET MOTORS</b>   | Articles consisting of a solid, liquid or hypergolic fuel contained in a cylinder fitted with one or more nozzles. They are designed to propel a rocket or a guided missile. The term includes:<br>ROCKET MOTORS;<br>ROCKET MOTORS WITH HYPERGOLIC LIQUIDS with or without expelling charge;<br>ROCKET MOTORS, LIQUID FUELLED.  |
| <b>ROCKETS</b>   | Articles consisting of a rocket motor and a payload which may be an explosive warhead or other device. The term includes guided missiles and:<br>ROCKETS, LINE-THROWING;<br>ROCKETS, LIQUID FUELLED with bursting charge;<br>ROCKETS with bursting charge;<br>ROCKETS with expelling charge;<br>ROCKETS with inert head.  |
| <b>SAFETY DEVICES, electrically initiated</b>                            | Articles which contain pyrotechnic substances or dangerous goods of other classes and are used in vehicles, vessels or aircraft to enhance safety to persons. Examples are air bag inflators, air bag modules, seat-belt pretensioners and pyromechanical devices. These pyromechanical devices are assembled components for tasks such as but not limited to separation, locking, or release-and-drive or occupant restraint. The term includes "SAFETY DEVICES, PYROTECHNIC". |
| <b>SIGNALS</b>   | Articles containing pyrotechnic substances designed to produce signals by means of sound, flame or smoke or any combinations thereof. The term includes:<br>SIGNAL DEVICES, HAND;<br>SIGNALS, DISTRESS, ship;<br>SIGNALS, RAILWAY TRACK, EXPLOSIVE;<br>SIGNALS, SMOKE.  |
| <b>SOUNDING DEVICES, EXPLOSIVE</b>                                       | Articles consisting of a charge of detonating explosive. They are dropped from ships and function when they reach a predetermined depth or the sea bed.   |
| <b>STABILIZED</b>  | Stabilized means that the substance is in a condition that precludes uncontrolled reaction. This may be achieved by methods such as the addition of an inhibiting chemical, degassing the substance to remove dissolved oxygen and inerting the air space in the package, or maintaining the substance under temperature control.   |
| <b>SUBSTANCES, EXPLOSIVE, VERY INSENSITIVE (SUBSTANCES, EVI), N.O.S.</b> | Substances which present a mass explosion hazard but which are so insensitive that there is very little probability of initiation, or of transition from burning to detonation (under normal conditions of transport) and which have passed test series 5.  |

Appendices

---

**TORPEDOES**

Articles containing an explosive or non-explosive propulsion system and designed to be propelled through water. They may contain an inert head or a warhead. The term includes:

- TORPEDOES, LIQUID FUELLED with inert head;
- TORPEDOES, LIQUID FUELLED with or without bursting charge;
- TORPEDOES with bursting charge.

**TRACERS FOR AMMUNITION**

Sealed articles containing pyrotechnic substances, designed to reveal the trajectory of a projectile.

**Warheads**

Articles consisting of detonating explosives. They are designed to be fitted to a rocket, guided missile or torpedo. They may contain a burster or expelling charge or bursting charge. The term includes:

- WARHEADS, ROCKET with burster or expelling charge;
- WARHEADS, ROCKET with bursting charge;
- WARHEADS, TORPEDO with bursting charge.



# INDEX





# Index

---

In this index, the word “see”, after the name in the substance, material or article column, means that it is a synonym and for details regarding the transport provisions reference shall be made to the entry in the Dangerous Goods List (chapter 3.2) which is relevant to the UN number/proper shipping name stated against the synonym.

## Method of indexing

Substances, materials and articles have been listed in the alphabetical order of their names. For the purpose of determining the alphabetical order, numbers and roman numerals (I), (II) etc. and the prefixes listed below have been disregarded, although they form an integral part of the name:

|                           |                     |
|---------------------------|---------------------|
| <i>N-</i>                 | <i>sym-</i>         |
| <i>n- or normal-</i>      | <i>uns-</i>         |
| <i>sec- or secondary-</i> | <i>cis-</i>         |
| <i>tert- or tertiary-</i> | <i>trans-</i>       |
| <i>o- or ortho-</i>       | <i>d-</i>           |
| <i>m- or meta-</i>        | <i>α- or alpha-</i> |
| <i>p- or para-</i>        | <i>β- or beta-</i>  |
|                           | <i>γ- or gamma-</i> |

## Note 1

Certain marine pollutants are identified only in the index. These marine pollutants have not been assigned to an N.O.S. or generic entry. These marine pollutants may possess properties of classes 1 to 8 and should be classified accordingly. A substance which does not fall within the criteria of these classes should be offered for transport as an ENVIRONMENTALLY HAZARDOUS SUBSTANCE, SOLID, N.O.S., UN 3077, or as an ENVIRONMENTALLY HAZARDOUS SUBSTANCE, LIQUID, N.O.S., UN 3082, under these entries in class 9.



| Substance, material or article   | MP | Class | UN No. |
|--|----|-------|--------|
| ACETAL   | –  | 3     | 1088   |
| ACETALDEHYDE   | –  | 3     | 1089   |
| ACETALDEHYDE AMMONIA   | –  | 9     | 1841   |
| Acetaldehyde diethyl acetal, <i>see</i>  | –  | 3     | 1088   |
| ACETALDEHYDE OXIME   | –  | 3     | 2332   |
| Acetaldol, <i>see</i>  | –  | 6.1   | 2839   |
| <i>beta</i> -Acetaldoxime, <i>see</i>  | –  | 3     | 2332   |
| ACETIC ACID, GLACIAL   | –  | 8     | 2789   |
| ACETIC ACID SOLUTION, more than 10% and less than 50% acid, by mass  | –  | 8     | 2790   |
| ACETIC ACID SOLUTION, not less than 50% but no more than 80% acid, by mass   | –  | 8     | 2790   |
| ACETIC ACID SOLUTION, more than 80% acid, by mass  | –  | 8     | 2789   |
| Acetic aldehyde, <i>see</i>  | –  | 3     | 1089   |
| ACETIC ANHYDRIDE   | –  | 8     | 1715   |
| Acetic oxide, <i>see</i>   | –  | 8     | 1715   |
| Acetoin, <i>see</i>  | –  | 3     | 2621   |
| ACETONE  | –  | 3     | 1090   |
| ACETONE CYANOHYDRIN, STABILIZED  | P  | 6.1   | 1541   |
| Acetone hexafluoride, <i>see</i>   | –  | 2.3   | 2420   |
| ACETONE OILS   | –  | 3     | 1091   |
| Acetone–pyrogallol copolymer 2-diazo-1-naphthol-5-sulphonate, <i>see</i>   | –  | 4.1   | 3228   |
| ACETONITRILE   | –  | 3     | 1648   |
| 3-Acetoxyprene, <i>see</i>   | –  | 3     | 2333   |
| Acetylacetone, <i>see</i>  | –  | 3     | 2310   |
| Acetyl acetone peroxide (concentration ≤ 32%, as a paste), <i>see</i>  | –  | 5.2   | 3106   |
| Acetyl acetone peroxide (concentration ≤ 35%, with diluent Type A), <i>see</i>                                     | –  | 5.2   | 3107   |
| Acetyl acetone peroxide (concentration ≤ 42%, with diluent Type A, and water, available oxygen ≤ 4.7%), <i>see</i> | –  | 5.2   | 3105   |
| ACETYL BROMIDE   | –  | 8     | 1716   |
| ACETYL CHLORIDE  | –  | 3     | 1717   |
| Acetyl cyclohexanesulphonyl peroxide (concentration ≤ 32%, with diluent Type B), <i>see</i>                        | –  | 5.2   | 3115   |
| Acetyl cyclohexanesulphonyl peroxide (concentration ≤ 82%, with water), <i>see</i>                                 | –  | 5.2   | 3112   |
| Acetylene dichloride, <i>see</i>   | –  | 3     | 1150   |
| ACETYLENE, DISSOLVED   | –  | 2.1   | 1001   |
| Acetylene, ethylene and propylene mixtures, refrigerated liquid, <i>see</i>  | –  | 2.1   | 3138   |
| ACETYLENE, SOLVENT FREE  | –  | 2.1   | 3374   |
| Acetylene tetrabromide, <i>see</i>   | P  | 6.1   | 2504   |
| Acetylene tetrachloride, <i>see</i>  | P  | 6.1   | 1702   |
| ACETYL IODIDE  | –  | 8     | 1898   |
| Acetyl ketene, stabilized, <i>see</i>  | –  | 6.1   | 2521   |
| ACETYL METHYL CARBINOL   | –  | 3     | 2621   |

## Index

| Substance, material or article   | MP | Class | UN No. |
|--|----|-------|--------|
| Acid butyl phosphate, <i>see</i>   | –  | 8     | 1718   |
| Acid mixture, hydrofluoric and sulphuric, <i>see</i>   | –  | 8     | 1786   |
| Acid mixture, nitrating acid, <i>see</i>   | –  | 8     | 1796   |
| Acid mixture, spent, nitrating acid, <i>see</i>  | –  | 8     | 1826   |
| Acraldehyde, stabilized, <i>see</i>  | P  | 6.1   | 1092   |
| ACRIDINE   | –  | 6.1   | 2713   |
| Acroleic acid, stabilized, <i>see</i>  | P  | 8     | 2218   |
| Acrolein diethyl acetal, <i>see</i>  | –  | 3     | 2374   |
| ACROLEIN DIMER, STABILIZED   | –  | 3     | 2607   |
| ACROLEIN, STABILIZED   | P  | 6.1   | 1092   |
| ACRYLAMIDE, SOLID  | –  | 6.1   | 2074   |
| ACRYLAMIDE SOLUTION  | –  | 6.1   | 3426   |
| Acrylic acid isobutyl ester, stabilized, <i>see</i>  | –  | 3     | 2527   |
| ACRYLIC ACID, STABILIZED   | P  | 8     | 2218   |
| Acrylic aldehyde, stabilized, <i>see</i>   | P  | 6.1   | 1092   |
| ACRYLONITRILE, STABILIZED  | –  | 3     | 1093   |
| Actinolite, <i>see</i>   | –  | 9     | 2212   |
| Activated carbon, <i>see</i>   | –  | 4.2   | 1362   |
| Activated charcoal, <i>see</i>   | –  | 4.2   | 1362   |
| ADHESIVES containing flammable liquid  | –  | 3     | 1133   |
| ADIPONITRILE   | –  | 6.1   | 2205   |
| ADSORBED GAS, FLAMMABLE, N.O.S.  | –  | 2.1   | 3510   |
| ADSORBED GAS, N.O.S.   | –  | 2.2   | 3511   |
| ADSORBED GAS, OXIDIZING, N.O.S.  | –  | 2.2   | 3513   |
| ADSORBED GAS, TOXIC, CORROSIVE, N.O.S.   | –  | 2.3   | 3516   |
| ADSORBED GAS, TOXIC, FLAMMABLE, CORROSIVE, N.O.S.  | –  | 2.3   | 3517   |
| ADSORBED GAS, TOXIC, FLAMMABLE, N.O.S.   | –  | 2.3   | 3514   |
| ADSORBED GAS, TOXIC, N.O.S.  | –  | 2.3   | 3512   |
| ADSORBED GAS, TOXIC, OXIDIZING, CORROSIVE, N.O.S.  | –  | 2.3   | 3518   |
| ADSORBED GAS, TOXIC, OXIDIZING, N.O.S.   | –  | 2.3   | 3515   |
| Aeroplane flares, <i>see</i> FLARES, AERIAL  | –  | –     | –      |
| AEROSOLS   | –  | 2     | 1950   |
| AGENT, BLASTING, TYPE B  | –  | 1.5D  | 0331   |
| AGENT, BLASTING, TYPE E  | –  | 1.5D  | 0332   |
| Air bag inflators, <i>see</i>  | –  | 1.4G  | 0503   |
| Air bag inflators, <i>see</i>  | –  | 9     | 3268   |
| Air bag modules, <i>see</i>  | –  | 1.4G  | 0503   |
| Air bag modules, <i>see</i>  | –  | 9     | 3268   |
| AIR, COMPRESSED  | –  | 2.2   | 1002   |
| AIRCRAFT HYDRAULIC POWER UNIT FUEL TANK<br>(containing a mixture of anhydrous hydrazine and methylhydrazine) | –  | 3     | 3165   |
| AIR, REFRIGERATED LIQUID   | –  | 2.2   | 1003   |
| ALCOHOLATES SOLUTION, N.O.S. in alcohol  | –  | 3     | 3274   |

| Substance, material or article  | MP | Class | UN No. |
|---|----|-------|--------|
| Alcohol C <sub>12</sub> -C <sub>16</sub> poly(1-6)ethoxylate, <i>see</i>  | P  | 9     | 3082   |
| Alcohol C <sub>6</sub> -C <sub>17</sub> (secondary) poly(3-6)ethoxylate, <i>see</i>   | P  | 9     | 3082   |
| ALCOHOLIC BEVERAGES, with more than 24% but not more than 70% alcohol by volume   | -  | 3     | 3065   |
| ALCOHOLIC BEVERAGES, with more than 70% alcohol by volume   | -  | 3     | 3065   |
| ALCOHOLS, FLAMMABLE, TOXIC, N.O.S.  | -  | 3     | 1986   |
| ALCOHOLS, N.O.S.  | -  | 3     | 1987   |
| ALDEHYDES, FLAMMABLE, TOXIC, N.O.S.   | -  | 3     | 1988   |
| ALDEHYDES, N.O.S.   | -  | 3     | 1989   |
| Aldicarb, <i>see</i> CARBAMATE PESTICIDE  | P  | -     | -      |
| ALDOL   | -  | 6.1   | 2839   |
| Aldrin, <i>see</i> ORGANOCHLORINE PESTICIDE   | P  | -     | -      |
| ALKALI METAL ALCOHOLATES, SELF-HEATING, CORROSIVE, N.O.S.   | -  | 4.2   | 3206   |
| ALKALI METAL ALLOY, LIQUID, N.O.S.  | -  | 4.3   | 1421   |
| ALKALI METAL AMALGAM, LIQUID  | -  | 4.3   | 1389   |
| ALKALI METAL AMALGAM, SOLID   | -  | 4.3   | 3401   |
| ALKALI METAL AMIDES   | -  | 4.3   | 1390   |
| ALKALI METAL DISPERSION   | -  | 4.3   | 1391   |
| ALKALI METAL DISPERSION, FLAMMABLE  | -  | 4.3   | 3482   |
| Alkaline caustic liquid, N.O.S., <i>see</i>   | -  | 8     | 1719   |
| ALKALINE EARTH METAL ALCOHOLATES, N.O.S.  | -  | 4.2   | 3205   |
| ALKALINE EARTH METAL ALLOY, N.O.S.  | -  | 4.3   | 1393   |
| ALKALINE EARTH METAL AMALGAM, LIQUID  | -  | 4.3   | 1392   |
| ALKALINE EARTH METAL AMALGAM, SOLID   | -  | 4.3   | 3402   |
| ALKALINE EARTH METAL DISPERSION   | -  | 4.3   | 1391   |
| ALKALINE EARTH METAL DISPERSION, FLAMMABLE  | -  | 4.3   | 3482   |
| ALKALOIDS, LIQUID, N.O.S.   | -  | 6.1   | 3140   |
| ALKALOIDS SALTS, LIQUID, N.O.S.   | -  | 6.1   | 3140   |
| ALKALOIDS SALTS, SOLID, N.O.S.  | -  | 6.1   | 1544   |
| ALKALOIDS, SOLID, N.O.S.  | -  | 6.1   | 1544   |
| Alkyl benzenesulphonates, branched and straight-chain (excluding C <sub>11</sub> -C <sub>13</sub> branched and straight-chain homologues), <i>see</i> | P  | 9     | 3082   |
| Alkyl(C <sub>12</sub> -C <sub>14</sub> )dimethylamine, <i>see</i> Note 1  | P  | -     | -      |
| Alkyl (C <sub>7</sub> -C <sub>9</sub> ) nitrates, <i>see</i> Note 1   | P  | -     | -      |
| ALKYLPHENOLS, LIQUID, N.O.S. (including C <sub>2</sub> -C <sub>12</sub> homologues)   | -  | 8     | 3145   |
| ALKYLPHENOLS, SOLID, N.O.S. (including C <sub>2</sub> -C <sub>12</sub> homologues)  | -  | 8     | 2430   |
| ALKYLSULPHONIC ACIDS, LIQUID with more than 5% free sulphuric acid  | -  | 8     | 2584   |
| ALKYLSULPHONIC ACIDS, LIQUID with not more than 5% free sulphuric acid  | -  | 8     | 2586   |
| ALKYLSULPHONIC ACIDS, SOLID with more than 5% free sulphuric acid   | -  | 8     | 2583   |
| ALKYLSULPHONIC ACIDS, SOLID with not more than 5% free sulphuric acid   | -  | 8     | 2585   |
| ALKYLSULPHURIC ACIDS  | -  | 8     | 2571   |



## Index

| Substance, material or article                  | MP | Class | UN No. |
|---|----|-------|--------|
| Allene, stabilized, <i>see</i>                  | –  | 2.1   | 2200   |
| ALLYL ACETATE                                   | –  | 3     | 2333   |
| ALLYL ALCOHOL                                   | P  | 6.1   | 1098   |
| ALLYLAMINE                                      | –  | 6.1   | 2334   |
| ALLYL BROMIDE                                   | P  | 3     | 1099   |
| ALLYL CHLORIDE                                  | –  | 3     | 1100   |
| Allyl chlorocarbonate, <i>see</i>               | –  | 6.1   | 1722   |
| ALLYL CHLOROFORMATE                             | –  | 6.1   | 1722   |
| ALLYL ETHYL ETHER                               | –  | 3     | 2335   |
| ALLYL FORMATE                                   | –  | 3     | 2336   |
| ALLYL GLYCIDYL ETHER                            | –  | 3     | 2219   |
| ALLYL IODIDE                                    | –  | 3     | 1723   |
| ALLYL ISOTHIOCYANATE, STABILIZED                | –  | 6.1   | 1545   |
| Allyl mustard oil, stabilized, <i>see</i>       | –  | 6.1   | 1545   |
| ALLYLTRICHLOROSILANE, STABILIZED                | –  | 8     | 1724   |
| Aluminium alkyls, <i>see</i>                    | –  | 4.2   | 3394   |
| Aluminium alkyl halides, liquid, <i>see</i>     | –  | 4.2   | 3394   |
| Aluminium alkyl halides, solid, <i>see</i>      | –  | 4.2   | 3393   |
| Aluminium alkyl hydrides, <i>see</i>            | –  | 4.2   | 3394   |
| ALUMINIUM BOROHYDRIDE                           | –  | 4.2   | 2870   |
| ALUMINIUM BOROHYDRIDE IN DEVICES                | –  | 4.2   | 2870   |
| ALUMINIUM BROMIDE, ANHYDROUS                    | –  | 8     | 1725   |
| ALUMINIUM BROMIDE SOLUTION                      | –  | 8     | 2580   |
| ALUMINIUM CARBIDE                               | –  | 4.3   | 1394   |
| ALUMINIUM CHLORIDE, ANHYDROUS                   | –  | 8     | 1726   |
| ALUMINIUM CHLORIDE SOLUTION                     | –  | 8     | 2581   |
| Aluminium dross, <i>see</i>                     | –  | 4.3   | 3170   |
| ALUMINIUM FERROSILICON POWDER                   | –  | 4.3   | 1395   |
| ALUMINIUM HYDRIDE                               | –  | 4.3   | 2463   |
| ALUMINIUM NITRATE                               | –  | 5.1   | 1438   |
| ALUMINIUM PHOSPHIDE                             | –  | 4.3   | 1397   |
| ALUMINIUM PHOSPHIDE PESTICIDE                   | –  | 6.1   | 3048   |
| ALUMINIUM POWDER, COATED                        | –  | 4.1   | 1309   |
| Aluminium powder, pyrophoric, <i>see</i>        | –  | 4.2   | 1383   |
| ALUMINIUM POWDER, UNCOATED                      | –  | 4.3   | 1396   |
| ALUMINIUM REMELTING BY-PRODUCTS                 | –  | 4.3   | 3170   |
| Aluminium residues, <i>see</i>                  | –  | 4.3   | 3170   |
| ALUMINIUM RESINATE                              | –  | 4.1   | 2715   |
| ALUMINIUM SILICON POWDER, UNCOATED              | –  | 4.3   | 1398   |
| Aluminium skimmings, <i>see</i>                 | –  | 4.3   | 3170   |
| ALUMINIUM SMELTING BY-PRODUCTS                  | –  | 4.3   | 3170   |
| Amatols, <i>see</i> EXPLOSIVE, BLASTING, TYPE B | –  | –     | –      |
| AMINES, FLAMMABLE, CORROSIVE, N.O.S.            | –  | 3     | 2733   |

| Substance, material or article   | MP | Class | UN No. |
|--|----|-------|--------|
| AMINES, LIQUID, CORROSIVE, FLAMMABLE, N.O.S.   | –  | 8     | 2734   |
| AMINES, LIQUID, CORROSIVE, N.O.S.  | –  | 8     | 2735   |
| AMINES, SOLID, CORROSIVE, N.O.S.   | –  | 8     | 3259   |
| 1-Amino-3-aminomethyl-3,5,5-trimethylcyclohexane, see  | –  | 8     | 2289   |
| <i>ortho</i> -Aminoanisole, see  | –  | 6.1   | 2431   |
| Aminobenzene, see  | P  | 6.1   | 1547   |
| 2-Aminobenzotrifluoride, see   | –  | 6.1   | 2942   |
| 3-Aminobenzotrifluoride, see   | –  | 6.1   | 2948   |
| 1-Aminobutane, see   | –  | 3     | 1125   |
| Aminocarb, see CARBAMATE PESTICIDE   | P  | –     | –      |
| 2-AMINO-4-CHLOROPHENOL   | –  | 6.1   | 2673   |
| Aminocyclohexane, see  | –  | 8     | 2357   |
| 2-AMINO-5-DIETHYLAMINOPENTANE  | –  | 6.1   | 2946   |
| Aminodimethylbenzenes, liquid, see   | –  | 6.1   | 1711   |
| Aminodimethylbenzenes, solid, see  | –  | 6.1   | 3452   |
| 2-AMINO-4,6-DINITROPHENOL, WETTED with not less than 20% water by mass   | –  | 4.1   | 3317   |
| Aminoethane, see   | –  | 2.1   | 1036   |
| Aminoethane, aqueous solution, see   | –  | 3     | 2270   |
| 1-Aminoethanol, see  | –  | 9     | 1841   |
| 2-Aminoethanol, see  | –  | 8     | 2491   |
| 2-(2-AMINOETHOXY)ETHANOL   | –  | 8     | 3055   |
| <i>N</i> -AMINOETHYLPIPERAZINE   | –  | 8     | 2815   |
| Aminomethane, anhydrous, see   | –  | 2.1   | 1061   |
| Aminomethane, aqueous solution, see  | –  | 3     | 1235   |
| 1-Amino-2-methylpropane, see   | –  | 3     | 1214   |
| 3-Aminomethyl-3,5,5-trimethylcyclohexylamine, see  | –  | 8     | 2289   |
| 1-Amino-2-nitrobenzene, see  | –  | 6.1   | 1661   |
| 1-Amino-3-nitrobenzene, see  | –  | 6.1   | 1661   |
| 1-Amino-4-nitrobenzene, see  | –  | 6.1   | 1661   |
| Aminophenoles, see   | –  | 6.1   | 2311   |
| AMINOPHENOLS ( <i>o</i> -, <i>m</i> -, <i>p</i> -)   | –  | 6.1   | 2512   |
| 1-Aminopropane, see  | –  | 3     | 1277   |
| 2-Aminopropane, see  | –  | 3     | 1221   |
| 3-Aminopropene, see  | –  | 6.1   | 2334   |
| AMINOPYRIDINES ( <i>o</i> -, <i>m</i> -, <i>p</i> -)   | –  | 6.1   | 2671   |
| Aminosulphonic acid, see   | –  | 8     | 2967   |
| AMMONIA, ANHYDROUS   | P  | 2.3   | 1005   |
| AMMONIA SOLUTION, relative density between 0.880 and 0.957 at 15°C in water, with more than 10% but not more than 35% ammonia, by mass | P  | 8     | 2672   |
| AMMONIA SOLUTION, relative density less than 0.880 at 15°C in water, with more than 35% but not more than 50% ammonia                  | P  | 2.2   | 2073   |
| AMMONIA SOLUTION, relative density less than 0.880 at 15°C in water, with more than 50% ammonia  | P  | 2.3   | 3318   |

## Index

| Substance, material or article   | MP | Class | UN No. |
|--|----|-------|--------|
| Ammonium acid fluoride, solid, <i>see</i>  | –  | 8     | 1727   |
| Ammonium acid fluoride solution, <i>see</i>  | –  | 8     | 2817   |
| AMMONIUM ARSENATE  | –  | 6.1   | 1546   |
| Ammonium bichromate, <i>see</i>  | –  | 5.1   | 1439   |
| Ammonium bifluoride, solid, <i>see</i>   | –  | 8     | 1727   |
| Ammonium bifluoride solution, <i>see</i>   | –  | 8     | 2817   |
| Ammonium bisulphate, <i>see</i>  | –  | 8     | 2506   |
| Ammonium bisulphite solution, <i>see</i>   | –  | 8     | 2693   |
| Ammonium bromate (transport prohibited)  | –  | –     | –      |
| Ammonium bromate solution (transport prohibited)   | –  | –     | –      |
| Ammonium chlorate (transport prohibited)   | –  | –     | –      |
| Ammonium chlorate solution (transport prohibited)  | –  | –     | –      |
| Ammonium chlorite (transport prohibited)   | –  | –     | –      |
| AMMONIUM DICHROMATE  | –  | 5.1   | 1439   |
| AMMONIUM DINITRO- <i>o</i> -CRESOLATE, SOLID   | P  | 6.1   | 1843   |
| AMMONIUM DINITRO- <i>o</i> -CRESOLATE SOLUTION   | P  | 6.1   | 3424   |
| AMMONIUM FLUORIDE  | –  | 6.1   | 2505   |
| AMMONIUM FLUOROSILICATE  | –  | 6.1   | 2854   |
| Ammonium hexafluorosilicate, <i>see</i>  | –  | 6.1   | 2854   |
| AMMONIUM HYDROGENDIFLUORIDE, SOLID   | –  | 8     | 1727   |
| AMMONIUM HYDROGENDIFLUORIDE SOLUTION   | –  | 8     | 2817   |
| AMMONIUM HYDROGEN SULPHATE   | –  | 8     | 2506   |
| Ammonium hypochlorite (transport prohibited)   | –  | –     | –      |
| AMMONIUM METAVANADATE  | –  | 6.1   | 2859   |
| AMMONIUM NITRATE BASED FERTILIZER  | –  | 5.1   | 2067   |
| AMMONIUM NITRATE BASED FERTILIZER  | –  | 9     | 2071   |
| AMMONIUM NITRATE EMULSION, intermediate for blasting explosives  | –  | 5.1   | 3375   |
| AMMONIUM NITRATE GEL, intermediate for blasting explosives   | –  | 5.1   | 3375   |
| AMMONIUM NITRATE liable to self-heating sufficient to initiate decomposition (transport prohibited)  | –  | –     | –      |
| AMMONIUM NITRATE, LIQUID (hot concentrated solution)   | –  | 5.1   | 2426   |
| AMMONIUM NITRATE SUSPENSION, intermediate for blasting explosives  | –  | 5.1   | 3375   |
| AMMONIUM NITRATE   | –  | 1.1D  | 0222   |
| AMMONIUM NITRATE with not more than 0.2% combustible substances, including any organic substance calculated as carbon, to the exclusion of any other added substance | –  | 5.1   | 1942   |
| Ammonium nitrite (transport prohibited)  | –  | –     | –      |
| AMMONIUM PERCHLORATE   | –  | 1.1D  | 0402   |
| AMMONIUM PERCHLORATE   | –  | 5.1   | 1442   |
| Ammonium permanganate (transport prohibited)   | –  | –     | –      |
| Ammonium permanganate solution (transport prohibited)  | –  | –     | –      |
| AMMONIUM PERSULPHATE   | –  | 5.1   | 1444   |
| AMMONIUM PICRATE dry or wetted with less than 10% water, by mass   | –  | 1.1D  | 0004   |

| Substance, material or article  | MP | Class | UN No. |
|---|----|-------|--------|
| AMMONIUM PICRATE, WETTED with not less than 10% water, by mass  | –  | 4.1   | 1310   |
| AMMONIUM POLYSULPHIDE SOLUTION  | –  | 8     | 2818   |
| AMMONIUM POLYVANADATE   | –  | 6.1   | 2861   |
| Ammonium silicofluoride, <i>see</i>   | –  | 6.1   | 2854   |
| AMMONIUM SULPHIDE SOLUTION  | –  | 8     | 2683   |
| Ammonium vanadate, <i>see</i>   | –  | 6.1   | 2859   |
| Ammunition, blank, <i>see</i> CARTRIDGES FOR WEAPONS, BLANK   | –  | –     | –      |
| Ammunition, fixed, semi-fixed or separate loading, <i>see</i> CARTRIDGES FOR WEAPONS, with bursting charge  | –  | –     | –      |
| AMMUNITION, ILLUMINATING with or without burster, expelling charge or propelling charge   | –  | 1.2G  | 0171   |
| AMMUNITION, ILLUMINATING with or without burster, expelling charge or propelling charge   | –  | 1.3G  | 0254   |
| AMMUNITION, ILLUMINATING with or without burster, expelling charge or propelling charge   | –  | 1.4G  | 0297   |
| AMMUNITION, INCENDIARY, liquid or gel, with burster, expelling charge or propelling charge  | –  | 1.3J  | 0247   |
| Ammunition, incendiary (water-activated contrivances) with burster, expelling charge or propelling charge, <i>see</i> CONTRIVANCES, WATER-ACTIVATED | –  | –     | –      |
| AMMUNITION, INCENDIARY, WHITE PHOSPHORUS with burster, expelling charge or propelling charge  | –  | 1.2H  | 0243   |
| AMMUNITION, INCENDIARY, WHITE PHOSPHORUS with burster, expelling charge or propelling charge  | –  | 1.3H  | 0244   |
| AMMUNITION, INCENDIARY with or without burster, expelling charge or propelling charge   | –  | 1.2G  | 0009   |
| AMMUNITION, INCENDIARY with or without burster, expelling charge or propelling charge   | –  | 1.3G  | 0010   |
| AMMUNITION, INCENDIARY with or without burster, expelling charge or propelling charge   | –  | 1.4G  | 0300   |
| Ammunition, industrial, <i>see</i> CARTRIDGES, OIL WELL <i>and</i> CARTRIDGES, POWER DEVICE   | –  | –     | –      |
| Ammunition, lachrymatory, <i>see</i> AMMUNITION, TEAR-PRODUCING   | –  | –     | –      |
| AMMUNITION, PRACTICE  | –  | 1.3G  | 0488   |
| AMMUNITION, PRACTICE  | –  | 1.4G  | 0362   |
| AMMUNITION, PROOF   | –  | 1.4G  | 0363   |
| Ammunition, smoke (water-activated contrivances), <i>see</i> CONTRIVANCES, WATER-ACTIVATED  | –  | –     | –      |
| AMMUNITION, SMOKE, WHITE PHOSPHORUS with burster, expelling charge or propelling charge   | –  | 1.2H  | 0245   |
| AMMUNITION, SMOKE, WHITE PHOSPHORUS with burster, expelling charge or propelling charge   | –  | 1.3H  | 0246   |
| AMMUNITION, SMOKE with or without burster, expelling charge or propelling charge  | –  | 1.2G  | 0015   |
| AMMUNITION, SMOKE with or without burster, expelling charge or propelling charge  | –  | 1.3G  | 0016   |
| AMMUNITION, SMOKE with or without burster, expelling charge or propelling charge  | –  | 1.4G  | 0303   |

## Index

| Substance, material or article   | MP | Class | UN No. |
|--|----|-------|--------|
| Ammunition, sporting, <i>see</i> CARTRIDGES FOR WEAPONS, INERT PROJECTILE                        | –  | –     | –      |
| AMMUNITION, TEAR-PRODUCING, NON-EXPLOSIVE without burster or expelling charge, non-fuzed         | –  | 6.1   | 2017   |
| AMMUNITION, TEAR-PRODUCING with burster, expelling charge or propelling charge                   | –  | 1.2G  | 0018   |
| AMMUNITION, TEAR-PRODUCING with burster, expelling charge or propelling charge                   | –  | 1.3G  | 0019   |
| AMMUNITION, TEAR-PRODUCING with burster, expelling charge or propelling charge                   | –  | 1.4G  | 0301   |
| AMMUNITION, TOXIC, NON-EXPLOSIVE without burster or expelling charge, non-fuzed                  | –  | 6.1   | 2016   |
| AMMUNITION, TOXIC with burster, expelling charge or propelling charge                            | –  | 1.2K  | 0020   |
| AMMUNITION, TOXIC with burster, expelling charge or propelling charge                            | –  | 1.3K  | 0021   |
| Amorces, <i>see</i> FIREWORKS  | –  | –     | –      |
| Amosite, <i>see</i>  | –  | 9     | 2212   |
| Amphibole asbestos, <i>see</i>   | –  | 9     | 2212   |
| AMYL ACETATES  | –  | 3     | 1104   |
| AMYL ACID PHOSPHATE  | –  | 8     | 2819   |
| Amyl alcohols, <i>see</i>  | –  | 3     | 1105   |
| Amyl aldehyde, <i>see</i>  | –  | 3     | 2058   |
| AMYLAMINE  | –  | 3     | 1106   |
| <i>n</i> -Amylbenzene, <i>see</i> Note 1   | P  | –     | –      |
| <i>secondary</i> -Amyl bromide, <i>see</i>   | –  | 3     | 2343   |
| AMYL BUTYRATES   | –  | 3     | 2620   |
| Amyl carbinol, <i>see</i>  | –  | 3     | 2282   |
| AMYL CHLORIDE  | –  | 3     | 1107   |
| <i>n</i> -AMYLENE  | –  | 3     | 1108   |
| AMYL FORMATES  | –  | 3     | 1109   |
| <i>tert</i> -Amyl hydroperoxide (concentration ≤ 88%, with diluent Type A and water), <i>see</i> | –  | 5.2   | 3107   |
| <i>normal</i> -Amyl mercaptan, <i>see</i>  | –  | 3     | 1111   |
| AMYL MERCAPTAN   | –  | 3     | 1111   |
| <i>n</i> -AMYL METHYL KETONE   | –  | 3     | 1110   |
| AMYL NITRATE   | –  | 3     | 1112   |
| AMYL NITRITE   | –  | 3     | 1113   |
| <i>normal</i> -Amyl nitrite, <i>see</i>  | –  | 3     | 1113   |
| <i>tert</i> -Amyl peroxy-2-ethylhexanoate (concentration ≤ 100%), <i>see</i>                     | –  | 5.2   | 3115   |
| <i>tert</i> -Amyl peroxy-2-ethylhexyl carbonate (concentration ≤ 100%), <i>see</i>               | –  | 5.2   | 3105   |
| <i>tert</i> -Amyl peroxy-3,5,5-trimethylhexanoate (concentration ≤ 100%), <i>see</i>             | –  | 5.2   | 3105   |
| <i>tert</i> -Amyl peroxyacetate (concentration ≤ 62%, with diluent Type A), <i>see</i>           | –  | 5.2   | 3105   |
| <i>tert</i> -Amyl peroxybenzoate (concentration ≤ 100%), <i>see</i>                              | –  | 5.2   | 3103   |

| Substance, material or article   | MP | Class | UN No. |
|--|----|-------|--------|
| <i>tert</i> -Amyl peroxyisopropyl carbonate (concentration ≤ 77%, with diluent Type A), <i>see</i> | –  | 5.2   | 3103   |
| <i>tert</i> -Amyl peroxyneodecanoate (concentration ≤ 47%, with diluent Type A), <i>see</i>        | –  | 5.2   | 3119   |
| <i>tert</i> -Amyl peroxyneodecanoate (concentration ≤ 77%, with diluent Type B), <i>see</i>        | –  | 5.2   | 3115   |
| <i>tert</i> -Amyl peroxy-pivalate (concentration ≤ 77%, with diluent Type B), <i>see</i>           | –  | 5.2   | 3113   |
| <i>tert</i> -Amyl peroxy-pivalate, not more than 42%, stable dispersion, in water                  | –  | 5.2   | 3119   |
| AMYLTRICHLOROSILANE  | –  | 8     | 1728   |
| ANILINE  | P  | 6.1   | 1547   |
| Aniline chloride, <i>see</i>   | –  | 6.1   | 1548   |
| ANILINE HYDROCHLORIDE  | –  | 6.1   | 1548   |
| Aniline oil, <i>see</i>  | P  | 6.1   | 1547   |
| Aniline salt, <i>see</i>   | –  | 6.1   | 1548   |
| Animal fabrics, oily, <i>see</i>   | –  | 4.2   | 1373   |
| Animal fibres, burnt, <i>see</i>   | –  | 4.2   | 1372   |
| Animal fibres, damp, <i>see</i>  | –  | 4.2   | 1372   |
| Animal fibres, oily, <i>see</i>  | –  | 4.2   | 1373   |
| Animal fibres, wet, <i>see</i>   | –  | 4.2   | 1372   |
| ANISIDINES   | –  | 6.1   | 2431   |
| ANISOLE  | –  | 3     | 2222   |
| ANISOYL CHLORIDE   | –  | 8     | 1729   |
| Anthophyllite, <i>see</i>  | –  | 9     | 2212   |
| ANTIMONY CHLORIDE  | –  | 8     | 1733   |
| Antimony chloride, solid, <i>see</i>   | –  | 8     | 1733   |
| ANTIMONY COMPOUND, INORGANIC, LIQUID, N.O.S.   | –  | 6.1   | 3141   |
| ANTIMONY COMPOUND, INORGANIC, SOLID, N.O.S.  | –  | 6.1   | 1549   |
| Antimony hydride, <i>see</i>   | –  | 2.3   | 2676   |
| ANTIMONY LACTATE   | –  | 6.1   | 1550   |
| Antimony(III) lactate, <i>see</i>  | –  | 6.1   | 1550   |
| ANTIMONY PENTACHLORIDE, LIQUID   | –  | 8     | 1730   |
| ANTIMONY PENTACHLORIDE SOLUTION  | –  | 8     | 1731   |
| ANTIMONY PENTAFLUORIDE   | –  | 8     | 1732   |
| Antimony perchloride, liquid, <i>see</i>   | –  | 8     | 1730   |
| Antimony perchloride solution, <i>see</i>  | –  | 8     | 1731   |
| ANTIMONY POTASSIUM TARTRATE  | –  | 6.1   | 1551   |
| ANTIMONY POWDER  | –  | 6.1   | 2871   |
| ANTIMONY TRICHLORIDE   | –  | 8     | 1733   |
| Antimony trihydride, <i>see</i>  | –  | 2.3   | 2676   |
| A.n.t.u, <i>see also</i> PESTICIDE, N.O.S.   | –  | 6.1   | 1651   |
| Aqua regia, <i>see</i>   | –  | 8     | 1798   |
| ARGON, COMPRESSED  | –  | 2.2   | 1006   |
| ARGON, REFRIGERATED LIQUID   | –  | 2.2   | 1951   |



## Index

| Substance, material or article  | MP | Class | UN No. |
|---|----|-------|--------|
| Arsenates, liquid, n.o.s., inorganic, <i>see</i>  | –  | 6.1   | 1556   |
| Arsenates, solid, n.o.s., inorganic, <i>see</i>   | –  | 6.1   | 1557   |
| ARSENIC   | –  | 6.1   | 1558   |
| ARSENIC ACID, LIQUID  | –  | 6.1   | 1553   |
| ARSENIC ACID, SOLID   | –  | 6.1   | 1554   |
| ARSENICAL DUST  | –  | 6.1   | 1562   |
| Arsenical flue dust, <i>see</i>   | –  | 6.1   | 1562   |
| ARSENICAL PESTICIDE, LIQUID, FLAMMABLE, TOXIC,<br>flashpoint less than 23°C   | –  | 3     | 2760   |
| ARSENICAL PESTICIDE, LIQUID, TOXIC  | –  | 6.1   | 2994   |
| ARSENICAL PESTICIDE, LIQUID, TOXIC, FLAMMABLE,<br>flashpoint not less than 23°C   | –  | 6.1   | 2993   |
| ARSENICAL PESTICIDE, SOLID, TOXIC   | –  | 6.1   | 2759   |
| ARSENIC BROMIDE   | –  | 6.1   | 1555   |
| Arsenic(III) bromide, <i>see</i>  | –  | 6.1   | 1555   |
| Arsenic chloride, <i>see</i>  | –  | 6.1   | 1560   |
| ARSENIC COMPOUND, LIQUID, N.O.S. inorganic, including:<br>Arsenates, n.o.s., Arsenites, n.o.s., and Arsenic sulphides, n.o.s. | –  | 6.1   | 1556   |
| ARSENIC COMPOUND, SOLID, N.O.S. inorganic, including:<br>Arsenates, n.o.s.; Arsenites, n.o.s.; and Arsenic sulphides, n.o.s.  | –  | 6.1   | 1557   |
| Arsenic compounds (pesticides), <i>see</i> ARSENICAL PESTICIDE  | –  | –     | –      |
| Arsenic hydride, <i>see</i>   | –  | 2.3   | 2188   |
| Arsenic(III) oxide, <i>see</i>  | –  | 6.1   | 1561   |
| Arsenic(V) oxide, <i>see</i>  | –  | 6.1   | 1559   |
| ARSENIC PENTOXIDE   | –  | 6.1   | 1559   |
| Arsenic sulphides, liquid, n.o.s., inorganic, <i>see</i>  | –  | 6.1   | 1556   |
| Arsenic sulphides, solid, n.o.s., inorganic, <i>see</i>   | –  | 6.1   | 1557   |
| Arsenic tribromide, <i>see</i>  | –  | 6.1   | 1555   |
| ARSENIC TRICHLORIDE   | –  | 6.1   | 1560   |
| ARSENIC TRIOXIDE  | –  | 6.1   | 1561   |
| Arsenious chloride, <i>see</i>  | –  | 6.1   | 1560   |
| Arsenites, liquid, n.o.s., inorganic, <i>see</i>  | –  | 6.1   | 1556   |
| Arsenites, solid, n.o.s., inorganic, <i>see</i>   | –  | 6.1   | 1557   |
| Arsenous bromide, <i>see</i>  | –  | 6.1   | 1555   |
| Arsenous chloride, <i>see</i>   | –  | 6.1   | 1560   |
| ARSINE  | –  | 2.3   | 2188   |
| ARSINE, ADSORBED  | –  | 2.3   | 3522   |
| ARTICLES CONTAINING FLAMMABLE GAS, N.O.S.   | –  | 2.1   | 3537   |
| ARTICLES CONTAINING NON-FLAMMABLE, NON-TOXIC GAS,<br>N.O.S.   | –  | 2.2   | 3538   |
| ARTICLES CONTAINING TOXIC GAS, N.O.S.   | –  | 2.3   | 3539   |
| ARTICLES CONTAINING FLAMMABLE LIQUID, N.O.S.  | –  | 3     | 3540   |
| ARTICLES CONTAINING FLAMMABLE SOLID, N.O.S.   | –  | 4.1   | 3541   |
| ARTICLES CONTAINING A SUBSTANCE LIABLE TO SPONTANEOUS<br>COMBUSTION, N.O.S.   | –  | 4.2   | 3542   |

| Substance, material or article  | MP | Class | UN No. |
|---|----|-------|--------|
| ARTICLES CONTAINING A SUBSTANCE WHICH IN CONTACT WITH WATER EMITS FLAMMABLE GASES, N.O.S. | –  | 4.3   | 3543   |
| ARTICLES CONTAINING OXIDIZING SUBSTANCE, N.O.S.   | –  | 5.1   | 3544   |
| ARTICLES CONTAINING ORGANIC PEROXIDE, N.O.S.  | –  | 5.2   | 3545   |
| ARTICLES CONTAINING TOXIC SUBSTANCE, N.O.S.   | –  | 6.1   | 3546   |
| ARTICLES CONTAINING CORROSIVE SUBSTANCE, N.O.S.   | –  | 8     | 3547   |
| ARTICLES CONTAINING MISCELLANEOUS DANGEROUS GOODS, N.O.S.                                 | –  | 9     | 3548   |
| ARTICLES, EEI   | –  | 1.6N  | 0486   |
| ARTICLES, EXPLOSIVE, EXTREMELY INSENSITIVE  | –  | 1.6N  | 0486   |
| ARTICLES, EXPLOSIVE, N.O.S.   | –  | 1.1C  | 0462   |
| ARTICLES, EXPLOSIVE, N.O.S.   | –  | 1.1D  | 0463   |
| ARTICLES, EXPLOSIVE, N.O.S.   | –  | 1.1E  | 0464   |
| ARTICLES, EXPLOSIVE, N.O.S.   | –  | 1.1F  | 0465   |
| ARTICLES, EXPLOSIVE, N.O.S.   | –  | 1.1L  | 0354   |
| ARTICLES, EXPLOSIVE, N.O.S.   | –  | 1.2C  | 0466   |
| ARTICLES, EXPLOSIVE, N.O.S.   | –  | 1.2D  | 0467   |
| ARTICLES, EXPLOSIVE, N.O.S.   | –  | 1.2E  | 0468   |
| ARTICLES, EXPLOSIVE, N.O.S.   | –  | 1.2F  | 0469   |
| ARTICLES, EXPLOSIVE, N.O.S.   | –  | 1.2L  | 0355   |
| ARTICLES, EXPLOSIVE, N.O.S.   | –  | 1.3C  | 0470   |
| ARTICLES, EXPLOSIVE, N.O.S.   | –  | 1.3L  | 0356   |
| ARTICLES, EXPLOSIVE, N.O.S.   | –  | 1.4B  | 0350   |
| ARTICLES, EXPLOSIVE, N.O.S.   | –  | 1.4C  | 0351   |
| ARTICLES, EXPLOSIVE, N.O.S.   | –  | 1.4D  | 0352   |
| ARTICLES, EXPLOSIVE, N.O.S.   | –  | 1.4E  | 0471   |
| ARTICLES, EXPLOSIVE, N.O.S.   | –  | 1.4F  | 0472   |
| ARTICLES, EXPLOSIVE, N.O.S.   | –  | 1.4G  | 0353   |
| ARTICLES, EXPLOSIVE, N.O.S.   | –  | 1.4S  | 0349   |
| ARTICLES, PRESSURIZED, HYDRAULIC (containing non-flammable gas)                           | –  | 2.2   | 3164   |
| ARTICLES, PRESSURIZED, PNEUMATIC (containing non-flammable gas)                           | –  | 2.2   | 3164   |
| ARTICLES, PYROPHORIC  | –  | 1.2L  | 0380   |
| ARTICLES, PYROTECHNIC for technical purposes  | –  | 1.1G  | 0428   |
| ARTICLES, PYROTECHNIC for technical purposes  | –  | 1.2G  | 0429   |
| ARTICLES, PYROTECHNIC for technical purposes  | –  | 1.3G  | 0430   |
| ARTICLES, PYROTECHNIC for technical purposes  | –  | 1.4G  | 0431   |
| ARTICLES, PYROTECHNIC for technical purposes  | –  | 1.4S  | 0432   |
| ARYLSULPHONIC ACIDS, LIQUID with more than 5% free sulphuric acid                         | –  | 8     | 2584   |
| ARYLSULPHONIC ACIDS, LIQUID with not more than 5% free sulphuric acid                     | –  | 8     | 2586   |
| ARYLSULPHONIC ACIDS, SOLID with more than 5% free sulphuric acid                          | –  | 8     | 2583   |

Index

| Substance, material or article   | MP | Class | UN No. |
|--|----|-------|--------|
| ARYLSULPHONIC ACIDS, SOLID with not more than 5% free sulphuric acid                           | –  | 8     | 2585   |
| ASBESTOS, AMPHIBOLE  | –  | 9     | 2212   |
| ASBESTOS, CHRYSOTILE   | –  | 9     | 2590   |
| Asphalt, <i>see</i>  | –  | 3     | 1999   |
| AVIATION REGULATED LIQUID, N.O.S.  | –  | 9     | 3334   |
| AVIATION REGULATED SOLID, N.O.S.   | –  | 9     | 3335   |
| Azinphos-ethyl, <i>see</i> ORGANOPHOSPHORUS PESTICIDE  | P  | –     | –      |
| Azinphos-methyl, <i>see</i> ORGANOPHOSPHORUS PESTICIDE   | P  | –     | –      |
| Aziridine, stabilized, <i>see</i>  | –  | 6.1   | 1185   |
| AZODICARBONAMIDE   | –  | 4.1   | 3242   |
| Azodicarbonamide formulation Type B (concentration < 100%, temperature controlled), <i>see</i> | –  | 4.1   | 3232   |
| Azodicarbonamide formulation Type C (concentration < 100%), <i>see</i>                         | –  | 4.1   | 3224   |
| Azodicarbonamide formulation Type C (concentration < 100%, temperature controlled), <i>see</i> | –  | 4.1   | 3234   |
| Azodicarbonamide formulation Type D (concentration < 100%), <i>see</i>                         | –  | 4.1   | 3226   |
| Azodicarbonamide formulation Type D (concentration < 100%, temperature controlled), <i>see</i> | –  | 4.1   | 3236   |
| 2,2'-Azodi(2,4-dimethyl-4-methoxyvaleronitrile) (concentration 100%), <i>see</i>               | –  | 4.1   | 3236   |
| 2,2'-Azodi(2,4-dimethylvaleronitrile) (concentration 100%), <i>see</i>                         | –  | 4.1   | 3236   |
| 2,2'-Azodi(ethyl 2-methylpropionate) (concentration 100%), <i>see</i>                          | –  | 4.1   | 3235   |
| 1,1'-Azodi(hexahydrobenzoxonitrile) (concentration 100%), <i>see</i>                           | –  | 4.1   | 3226   |
| 2,2'-Azodi(isobutyronitrile), as a water-based paste (concentration ≤ 50%), <i>see</i>         | –  | 4.1   | 3224   |
| 2,2'-Azodi(isobutyronitrile) (concentration 100%), <i>see</i>                                  | –  | 4.1   | 3234   |
| 2,2'-Azodi(2-methylbutyronitrile) (concentration 100%), <i>see</i>                             | –  | 4.1   | 3236   |
| Bag charges, <i>see</i> CHARGES, PROPELLING, FOR CANNON  | –  | –     | –      |
| Ballistite, <i>see</i> POWDER, SMOKELESS   | –  | –     | –      |
| Bangalore torpedoes, <i>see</i> MINES, WITH BURSTING CHARGE                                    | –  | –     | –      |
| BARIUM   | –  | 4.3   | 1400   |
| Barium alloys, non-pyrophoric, <i>see</i>  | –  | 4.3   | 1393   |
| BARIUM ALLOYS, PYROPHORIC  | –  | 4.2   | 1854   |
| Barium amalgams, liquid, <i>see</i>  | –  | 4.3   | 1392   |
| Barium amalgams, solid, <i>see</i>   | –  | 4.3   | 3402   |
| BARIUM AZIDE, dry or wetted with less than 50% water, by mass                                  | –  | 1.1A  | 0224   |
| BARIUM AZIDE, WETTED with not less than 50% water, by mass                                     | –  | 4.1   | 1571   |
| BARIUM BROMATE   | –  | 5.1   | 2719   |
| BARIUM CHLORATE, SOLID   | –  | 5.1   | 1445   |
| BARIUM CHLORATE SOLUTION   | –  | 5.1   | 3405   |
| BARIUM COMPOUND, N.O.S.  | –  | 6.1   | 1564   |
| BARIUM CYANIDE   | P  | 6.1   | 1565   |
| Barium dispersions, <i>see</i>   | –  | 4.3   | 1391   |

|   | Substance, material or article  | MP | Class | UN No. |
|---|---|----|-------|--------|
|   | BARIUM HYPOCHLORITE with more than 22% available chlorine                     | –  | 5.1   | 2741   |
|   | Barium monoxide, <i>see</i>   | –  | 6.1   | 1884   |
|   | BARIUM NITRATE  | –  | 5.1   | 1446   |
|   | BARIUM OXIDE  | –  | 6.1   | 1884   |
|   | BARIUM PERCHLORATE, SOLID   | –  | 5.1   | 1447   |
|   | BARIUM PERCHLORATE SOLUTION   | –  | 5.1   | 3406   |
|   | BARIUM PERMANGANATE   | –  | 5.1   | 1448   |
|   | BARIUM PEROXIDE   | –  | 5.1   | 1449   |
|   | Barium powder, pyrophoric, <i>see</i>   | –  | 4.2   | 1383   |
|   | Batteries, containing lithium, <i>see</i>                                     | –  | 9     | 3090   |
| △ | BATTERIES, CONTAINING METALLIC SODIUM OR SODIUM ALLOY                         | –  | 4.3   | 3292   |
|   | BATTERIES, DRY, CONTAINING POTASSIUM HYDROXIDE, SOLID electric storage        | –  | 8     | 3028   |
|   | BATTERIES, NICKEL-METAL HYDRIDE   | –  | 9     | 3496   |
| ■ | Batteries, sodium nickel chloride, <i>see</i>                                 | –  | 4.3   | 3292   |
|   | BATTERIES, WET, FILLED WITH ACID, electric storage                            | –  | 8     | 2794   |
|   | BATTERIES, WET, FILLED WITH ALKALI, electric storage                          | –  | 8     | 2795   |
|   | BATTERIES, WET, NON-SPILLABLE, electric storage                               | –  | 8     | 2800   |
|   | Battery acid, <i>see</i>  | –  | 8     | 2796   |
|   | BATTERY FLUID, ACID   | –  | 8     | 2796   |
|   | BATTERY FLUID, ALKALI   | –  | 8     | 2797   |
|   | Battery, lithium, <i>see</i>  | –  | 9     | 3090   |
|   | BATTERY-POWERED EQUIPMENT   | –  | 9     | 3171   |
|   | BATTERY-POWERED VEHICLE   | –  | 9     | 3171   |
|   | Bendiocarb, <i>see</i> CARBAMATE PESTICIDE                                    | P  | –     | –      |
|   | Benfuracarb, <i>see</i> CARBAMATE PESTICIDE                                   | –  | –     | –      |
|   | Benomyl, <i>see</i> Note 1  | P  | –     | –      |
|   | Benquinox, <i>see</i> PESTICIDE, N.O.S.                                       | P  | –     | –      |
|   | Benzal chloride, <i>see</i>   | –  | 6.1   | 1886   |
|   | BENZALDEHYDE  | –  | 9     | 1990   |
|   | BENZENE   | –  | 3     | 1114   |
|   | 1,3-Benzenediol, <i>see</i>   | –  | 6.1   | 2876   |
|   | Benzene-1,3-disulphonyl hydrazide, as a paste (concentration 52%), <i>see</i> | –  | 4.1   | 3226   |
|   | Benzene phosphorus dichloride, <i>see</i>                                     | –  | 8     | 2798   |
|   | Benzene phosphorus thiochloride, <i>see</i>                                   | –  | 8     | 2799   |
|   | BENZENESULPHONYL CHLORIDE   | –  | 8     | 2225   |
|   | Benzene sulphonylhydrazide (concentration 100%), <i>see</i>                   | –  | 4.1   | 3226   |
|   | Benzenethiol, <i>see</i>  | –  | 6.1   | 2337   |
|   | Benzhydryl bromide, <i>see</i>  | –  | 8     | 1770   |
|   | BENZIDINE   | –  | 6.1   | 1885   |
|   | Benzol, <i>see</i>  | –  | 3     | 1114   |
|   | Benzolene, <i>see</i>   | –  | 3     | 1268   |
|   | BENZONITRILE  | –  | 6.1   | 2224   |

## Index

| Substance, material or article   | MP | Class | UN No. |
|--|----|-------|--------|
| BENZOQUINONE   | –  | 6.1   | 2587   |
| Benzosulphochloride, <i>see</i>  | –  | 8     | 2225   |
| BENZOTRICHLORIDE   | –  | 8     | 2226   |
| BENZOTRIFLUORIDE   | –  | 3     | 2338   |
| BENZOYL CHLORIDE   | –  | 8     | 1736   |
| BENZYL BROMIDE   | –  | 6.1   | 1737   |
| BENZYL CHLORIDE  | –  | 6.1   | 1738   |
| Benzyl chlorocarbonate, <i>see</i>   | P  | 8     | 1739   |
| BENZYL CHLOROFORMATE   | P  | 8     | 1739   |
| Benzyl cyanide, <i>see</i>   | –  | 6.1   | 2470   |
| Benzyl dichloride, <i>see</i>  | –  | 6.1   | 1886   |
| BENZYLDIMETHYLAMINE  | –  | 8     | 2619   |
| 4-(Benzyl(ethyl)amino)-3-ethoxybenzenediazonium zinc chloride<br>(concentration 100%), <i>see</i>  | –  | 4.1   | 3226   |
| BENZYLIDENE CHLORIDE   | –  | 6.1   | 1886   |
| BENZYL IODIDE  | –  | 6.1   | 2653   |
| 4-(Benzyl(methyl)amino)-3-ethoxybenzenediazonium zinc chloride<br>(concentration 100%), <i>see</i> | –  | 4.1   | 3236   |
| BERYLLIUM COMPOUND, N.O.S.   | –  | 6.1   | 1566   |
| BERYLLIUM NITRATE  | –  | 5.1   | 2464   |
| BERYLLIUM POWDER   | –  | 6.1   | 1567   |
| <i>gamma</i> -Bhc, <i>see</i> ORGANOCHLORINE PESTICIDE   | P  | –     | –      |
| BHUSA  | –  | 4.1   | 1327   |
| Bichloroacetic acid, <i>see</i>  | –  | 8     | 1764   |
| BICYCLO[2.2.1]-HEPTA-2,5-DIENE, STABILIZED   | –  | 3     | 2251   |
| Bifluorides, N.O.S., <i>see</i>  | –  | 8     | 1740   |
| Binapacryl, <i>see</i> SUBSTITUTED NITROPHENOL PESTICIDE   | P  | –     | –      |
| BIOLOGICAL SUBSTANCE, CATEGORY B   | –  | 6.2   | 3373   |
| BIOMEDICAL WASTE, N.O.S.   | –  | 6.2   | 3291   |
| (BIO)MEDICAL WASTE, N.O.S.   | –  | 6.2   | 3291   |
| BIPYRIDILIUM PESTICIDE, LIQUID, FLAMMABLE, TOXIC,<br>flashpoint less than 23°C                     | –  | 3     | 2782   |
| BIPYRIDILIUM PESTICIDE, LIQUID, TOXIC  | –  | 6.1   | 3016   |
| BIPYRIDILIUM PESTICIDE, LIQUID, TOXIC, FLAMMABLE,<br>flashpoint not less than 23°C                 | –  | 6.1   | 3015   |
| BIPYRIDILIUM PESTICIDE, SOLID, TOXIC   | –  | 6.1   | 2781   |
| Bis-, <i>see</i> Di-   | –  | –     | –      |
| <i>N,N</i> -Bis(2-hydroxyethyl)oleamide (loa), <i>see</i> Note 1                                   | P  | –     | –      |
| BISULPHATES, AQUEOUS SOLUTION  | –  | 8     | 2837   |
| BISULPHITES, AQUEOUS SOLUTION, N.O.S.  | –  | 8     | 2693   |
| Bitumen, <i>see</i>  | –  | 3     | 1999   |
| BLACK POWDER, COMPRESSED   | –  | 1.1D  | 0028   |
| BLACK POWDER granular, or as a meal  | –  | 1.1D  | 0027   |
| BLACK POWDER, IN PELLETS   | –  | 1.1D  | 0028   |

| Substance, material or article   | MP | Class | UN No. |
|--|----|-------|--------|
| Blasticidin-S-3, <i>see</i> PESTICIDE, N.O.S.                                | –  | –     | –      |
| Bleaching powder, <i>see</i>   | P  | 5.1   | 2208   |
| Bleach liquor, <i>see</i>  | –  | 8     | 1791   |
| Bombs, illuminating, <i>see</i> AMMUNITION, ILLUMINATING                     | –  | –     | –      |
| BOMBS, PHOTO-FLASH   | –  | 1.1D  | 0038   |
| BOMBS, PHOTO-FLASH   | –  | 1.1F  | 0037   |
| BOMBS, PHOTO-FLASH   | –  | 1.2G  | 0039   |
| BOMBS, PHOTO-FLASH   | –  | 1.3G  | 0299   |
| BOMBS, SMOKE, NON-EXPLOSIVE with corrosive liquid, without initiating device | –  | 8     | 2028   |
| Bombs, target identification, <i>see</i> AMMUNITION, ILLUMINATING            | –  | –     | –      |
| BOMBS with bursting charge   | –  | 1.1D  | 0034   |
| BOMBS with bursting charge   | –  | 1.1F  | 0033   |
| BOMBS with bursting charge   | –  | 1.2D  | 0035   |
| BOMBS with bursting charge   | –  | 1.2F  | 0291   |
| BOMBS WITH FLAMMABLE LIQUID with bursting charge                             | –  | 1.1J  | 0399   |
| BOMBS WITH FLAMMABLE LIQUID with bursting charge                             | –  | 1.2J  | 0400   |
| BOOSTERS WITH DETONATOR  | –  | 1.1B  | 0225   |
| BOOSTERS WITH DETONATOR  | –  | 1.2B  | 0268   |
| BOOSTERS without detonator   | –  | 1.1D  | 0042   |
| BOOSTERS without detonator   | –  | 1.2D  | 0283   |
| Borate and chlorate mixture, <i>see</i>                                      | –  | 5.1   | 1458   |
| BORNEOL  | –  | 4.1   | 1312   |
| Bornyl alcohol, <i>see</i>   | –  | 4.1   | 1312   |
| Boroethane, compressed, <i>see</i>   | –  | 2.3   | 1911   |
| Boron bromide, <i>see</i>  | –  | 8     | 2692   |
| Boron fluoride, compressed, <i>see</i>                                       | –  | 2.3   | 1008   |
| BORON TRIBROMIDE   | –  | 8     | 2692   |
| BORON TRICHLORIDE  | –  | 2.3   | 1741   |
| BORON TRIFLUORIDE  | –  | 2.3   | 1008   |
| BORON TRIFLUORIDE ACETIC ACID COMPLEX, LIQUID                                | –  | 8     | 1742   |
| BORON TRIFLUORIDE ACETIC ACID COMPLEX, SOLID                                 | –  | 8     | 3419   |
| BORON TRIFLUORIDE, ADSORBED  | –  | 2.3   | 3519   |
| BORON TRIFLUORIDE DIETHYL ETHERATE   | –  | 8     | 2604   |
| BORON TRIFLUORIDE DIHYDRATE  | –  | 8     | 2851   |
| BORON TRIFLUORIDE DIMETHYL ETHERATE  | –  | 4.3   | 2965   |
| BORON TRIFLUORIDE PROPIONIC ACID COMPLEX, LIQUID                             | –  | 8     | 1743   |
| BORON TRIFLUORIDE PROPIONIC ACID COMPLEX, SOLID                              | –  | 8     | 3420   |
| Brodifacoum, <i>see</i> COUMARIN DERIVATIVE PESTICIDE                        | P  | –     | –      |
| BROMATES, INORGANIC, AQUEOUS SOLUTION, N.O.S.                                | –  | 5.1   | 3213   |
| BROMATES, INORGANIC, N.O.S.  | –  | 5.1   | 1450   |
| BROMINE  | –  | 8     | 1744   |
| BROMINE CHLORIDE   | –  | 2.3   | 2901   |



## Index

| Substance, material or article                         | MP | Class | UN No. |
|--|----|-------|--------|
| Bromine cyanide, <i>see</i>                            | P  | 6.1   | 1889   |
| BROMINE PENTAFLUORIDE                                  | –  | 5.1   | 1745   |
| BROMINE SOLUTION                                       | –  | 8     | 1744   |
| BROMINE TRIFLUORIDE                                    | –  | 5.1   | 1746   |
| BROMOACETIC ACID, SOLID                                | –  | 8     | 3425   |
| BROMOACETIC ACID SOLUTION                              | –  | 8     | 1938   |
| BROMOACETONE   | P  | 6.1   | 1569   |
| <i>omega</i> -Bromoacetone, <i>see</i>                 | –  | 6.1   | 2645   |
| BROMOACETYL BROMIDE                                    | –  | 8     | 2513   |
| Bromoallylene, <i>see</i>                              | P  | 3     | 1099   |
| BROMOBENZENE   | P  | 3     | 2514   |
| BROMOBENZYL CYANIDES, LIQUID                           | –  | 6.1   | 1694   |
| BROMOBENZYL CYANIDES, SOLID                            | –  | 6.1   | 3449   |
| 1-BROMOBUTANE  | –  | 3     | 1126   |
| 2-BROMOBUTANE  | –  | 3     | 2339   |
| Bromochlorodifluoromethane, <i>see</i>                 | –  | 2.2   | 1974   |
| BROMOCHLOROMETHANE                                     | –  | 6.1   | 1887   |
| 1-BROMO-3-CHLOROPROPANE                                | –  | 6.1   | 2688   |
| Bromocyane, <i>see</i>                                 | P  | 6.1   | 1889   |
| Bromodiphenylmethane, <i>see</i>                       | –  | 8     | 1770   |
| 1-Bromo-2,3-epoxypropane, <i>see</i>                   | P  | 6.1   | 2558   |
| Bromoethane, <i>see</i>                                | –  | 3     | 1891   |
| 2-BROMOETHYL ETHYL ETHER                               | –  | 3     | 2340   |
| BROMOFORM  | P  | 6.1   | 2515   |
| Bromomethane, <i>see</i>                               | –  | 2.3   | 1062   |
| 1-BROMO-3-METHYLBUTANE                                 | –  | 3     | 2341   |
| BROMOMETHYLPROPANES                                    | –  | 3     | 2342   |
| Bromonitrobenzenes, liquid, <i>see</i>                 | –  | 6.1   | 2732   |
| Bromonitrobenzenes, solid, <i>see</i>                  | –  | 6.1   | 3459   |
| 2-BROMO-2-NITROPROPANE-1,3-DIOL                        | –  | 4.1   | 3241   |
| 2-BROMOPENTANE   | –  | 3     | 2343   |
| Bromophos-ethyl, <i>see</i> ORGANOPHOSPHORUS PESTICIDE | P  | –     | –      |
| BROMOPROPANES  | –  | 3     | 2344   |
| 3-Bromopropene, <i>see</i>                             | P  | 3     | 1099   |
| 3-BROMOPROPYNE   | –  | 3     | 2345   |
| 3-Bromo-1-propyne, <i>see</i>                          | –  | 3     | 2345   |
| <i>alpha</i> -Bromotoluene, <i>see</i>                 | –  | 6.1   | 1737   |
| BROMOTRIFLUOROETHYLENE                                 | –  | 2.1   | 2419   |
| BROMOTRIFLUOROMETHANE                                  | –  | 2.2   | 1009   |
| Bromoxynil, <i>see</i> PESTICIDE, N.O.S.               | P  | –     | –      |
| Bronopol, <i>see</i>                                   | –  | 4.1   | 3241   |
| BRUCINE  | –  | 6.1   | 1570   |
| BURSTERS explosive                                     | –  | 1.1D  | 0043   |

| Substance, material or article  | MP | Class | UN No. |
|---|----|-------|--------|
| But-1-yne, stabilized, see  | –  | 2.1   | 2452   |
| △ BUTADIENES AND HYDROCARBON MIXTURE, STABILIZED<br>containing more than 20% butadienes, stabilized | –  | 2.1   | 1010   |
| BUTADIENES, STABILIZED  | –  | 2.1   | 1010   |
| Butanal, see  | –  | 3     | 1129   |
| Butanal oxime, see  | –  | 3     | 2840   |
| BUTANE  | –  | 2.1   | 1011   |
| BUTANEDIONE   | –  | 3     | 2346   |
| Butane-1-thiol, see   | –  | 3     | 2347   |
| Butanoic acid, see  | –  | 8     | 2820   |
| Butanoic anhydride, see   | –  | 8     | 2739   |
| Butan-2-ol, see   | –  | 3     | 1120   |
| 1-Butanol, see  | –  | 3     | 1120   |
| Butanol, secondary, see   | –  | 3     | 1120   |
| Butanol, tertiary, see  | –  | 3     | 1120   |
| 3-Butanolal, see  | –  | 6.1   | 2839   |
| BUTANOLS  | –  | 3     | 1120   |
| 2-Butanone, see   | –  | 3     | 1193   |
| Butanoyl chloride, see  | –  | 3     | 2353   |
| 2-Butenal, stabilized, see  | P  | 6.1   | 1143   |
| Butene, see   | –  | 2.1   | 1012   |
| But-1-ene-3-one, stabilized, see  | –  | 6.1   | 1251   |
| 1,2-Butene oxide, stabilized, see   | –  | 3     | 3022   |
| 2-Butenoic acid, liquid, see  | –  | 8     | 3472   |
| 2-Butenoic acid, solid, see   | –  | 8     | 2823   |
| 2-Buten-1-ol, see   | –  | 3     | 2614   |
| Butocarboxim, see CARBAMATE PESTICIDE   | –  | –     | –      |
| BUTYL ACETATES  | –  | 3     | 1123   |
| Butyl acetate, secondary, see   | –  | 3     | 1123   |
| BUTYL ACID PHOSPHATE  | –  | 8     | 1718   |
| BUTYL ACRYLATES, STABILIZED   | –  | 3     | 2348   |
| Butyl alcohols, see   | –  | 3     | 1120   |
| Butyl aldehyde, see   | –  | 3     | 1129   |
| <i>n</i> -BUTYLAMINE  | –  | 3     | 1125   |
| <i>N</i> -BUTYLANILINE  | –  | 6.1   | 2738   |
| BUTYLBENZENES   | P  | 3     | 2709   |
| Butyl benzyl phthalate, see   | P  | 9     | 3082   |
| <i>n</i> -Butyl bromide, see  | –  | 3     | 1126   |
| <i>secondary</i> -Butyl bromide, see  | –  | 3     | 2339   |
| <i>tertiary</i> -Butyl bromide, see   | –  | 3     | 2342   |
| Butyl butyrate, see   | –  | 3     | 3272   |
| <i>n</i> -Butyl chloride, see   | –  | 3     | 1127   |
| <i>secondary</i> -Butyl chloride, see   | –  | 3     | 1127   |

## Index

| Substance, material or article  | MP | Class | UN No. |
|---|----|-------|--------|
| <i>tertiary</i> -Butyl chloride, <i>see</i>   | –  | 3     | 1127   |
| <i>n</i> -BUTYL CHLOROFORMATE   | –  | 6.1   | 2743   |
| <i>tert</i> -Butyl cumyl peroxide (concentration > 42–100%), <i>see</i>   | –  | 5.2   | 3109   |
| <i>tert</i> -Butyl cumyl peroxide (concentration ≤ 52%, with inert solid), <i>see</i>   | –  | 5.2   | 3108   |
| <i>tert</i> -BUTYLCYCLOHEXYL CHLOROFORMATE  | –  | 6.1   | 2747   |
| <i>N</i> <sup>2</sup> - <i>tert</i> -Butyl- <i>N</i> <sup>4</sup> -cyclopropyl-6-methylthio-1,3,5-triazine-2,4-diamine, <i>see</i>    | P  | 9     | 3077   |
| <i>n</i> -Butyl 4,4-di-( <i>tert</i> -butylperoxy)valerate (concentration ≤ 52%, with inert solid), <i>see</i>                        | –  | 5.2   | 3108   |
| <i>n</i> -Butyl 4,4-di-( <i>tert</i> -butylperoxy)valerate (concentration > 52–100%), <i>see</i>                                      | –  | 5.2   | 3103   |
| BUTYLENE  | –  | 2.1   | 1012   |
| 1-butylene, <i>see</i>  | –  | 2.1   | 1012   |
| <i>cis</i> -2-butylene, <i>see</i>  | –  | 2.1   | 1012   |
| <i>trans</i> -2-butylene, <i>see</i>  | –  | 2.1   | 1012   |
| ■ Butylenes mixture, <i>see</i>   | –  | 2.1   | 1012   |
| 1,2-BUTYLENE OXIDE, STABILIZED  | –  | 3     | 3022   |
| Butyl ethers, <i>see</i>  | –  | 3     | 1149   |
| Butyl ethyl ether, <i>see</i>   | –  | 3     | 1179   |
| <i>n</i> -BUTYL FORMATE   | –  | 3     | 1128   |
| <i>tert</i> -Butyl hydroperoxide (concentration ≤ 56%, with diluent Type B), <i>see</i>   | –  | 5.2   | 3109   |
| <i>tert</i> -Butyl hydroperoxide (concentration ≤ 72%, with water), <i>see</i>  | –  | 5.2   | 3109   |
| <i>tert</i> -Butyl hydroperoxide (concentration ≤ 79%, with water), <i>see</i>  | –  | 5.2   | 3107   |
| <i>tert</i> -Butyl hydroperoxide (concentration > 79–90%, with water), <i>see</i>   | –  | 5.2   | 3103   |
| <i>tert</i> -Butyl hydroperoxide (concentration ≤ 80%, with diluent Type A), <i>see</i>   | –  | 5.2   | 3105   |
| <i>tert</i> -Butyl hydroperoxide (concentration < 82%) + di- <i>tert</i> -butyl peroxide (concentration > 9%), with water, <i>see</i> | –  | 5.2   | 3103   |
| <i>tert</i> -BUTYL HYPOCHLORITE   | –  | 4.2   | 3255   |
| <i>N,n</i> -BUTYLIMIDAZOLE  | –  | 6.1   | 2690   |
| <i>N,n</i> -Butyliminazole, <i>see</i>  | –  | 6.1   | 2690   |
| <i>secondary</i> -Butyl iodide, <i>see</i>  | –  | 3     | 2390   |
| <i>tertiary</i> -Butyl iodide, <i>see</i>   | –  | 3     | 2391   |
| <i>tert</i> -BUTYL ISOCYANATE   | –  | 6.1   | 2484   |
| <i>n</i> -BUTYL ISOCYANATE  | –  | 6.1   | 2485   |
| BUTYL MERCAPTAN   | –  | 3     | 2347   |
| <i>n</i> -BUTYL METHACRYLATE, STABILIZED  | –  | 3     | 2227   |
| Butyl 2-methylacrylate, stabilized, <i>see</i>  | –  | 3     | 2227   |
| BUTYL METHYL ETHER  | –  | 3     | 2350   |
| <i>tert</i> -Butyl monoperoxymaleate (concentration ≤ 52%, as a paste), <i>see</i>  | –  | 5.2   | 3108   |
| <i>tert</i> -Butyl monoperoxymaleate (concentration ≤ 52%, with diluent Type A), <i>see</i>   | –  | 5.2   | 3103   |
| <i>tert</i> -Butyl monoperoxymaleate (concentration ≤ 52%, with inert solid), <i>see</i>  | –  | 5.2   | 3108   |

| Substance, material or article  | MP | Class | UN No. |
|---|----|-------|--------|
| <i>tert</i> -Butyl monoperoxymaleate (concentration > 52–100%), see   | –  | 5.2   | 3102   |
| <b>BUTYL NITRITES</b>   | –  | 3     | 2351   |
| <i>tert</i> -Butyl peroxyacetate (concentration ≤ 32%, with diluent Type B), see  | –  | 5.2   | 3109   |
| <i>tert</i> -Butyl peroxyacetate (concentration > 32–52%, with diluent Type A), see   | –  | 5.2   | 3103   |
| <i>tert</i> -Butyl peroxyacetate (concentration > 52–77%, with diluent Type A), see   | –  | 5.2   | 3101   |
| <i>tert</i> -Butyl peroxybenzoate (concentration ≤ 52%, with inert solid), see  | –  | 5.2   | 3106   |
| <i>tert</i> -Butyl peroxybenzoate (concentration > 52–77%, with diluent Type A), see  | –  | 5.2   | 3105   |
| <i>tert</i> -Butyl peroxybenzoate (concentration > 77–100%, with diluent Type A), see   | –  | 5.2   | 3103   |
| <i>tert</i> -Butyl peroxybutyl fumarate (concentration ≤ 52%, with diluent Type A), see   | –  | 5.2   | 3105   |
| <i>tert</i> -Butyl peroxycrotonate (concentration ≤ 77%, with diluent Type A), see  | –  | 5.2   | 3105   |
| <i>tert</i> -Butyl peroxydiethylacetate (concentration ≤ 100%), see   | –  | 5.2   | 3113   |
| <i>tert</i> -Butyl peroxy-2-ethylhexanoate (concentration ≤ 12%) + 2,2-di-( <i>tert</i> -butylperoxy)butane (concentration ≤ 14%), with diluent Type A and inert solid, see | –  | 5.2   | 3106   |
| <i>tert</i> -Butyl peroxy-2-ethylhexanoate (concentration ≤ 31%) + 2,2-di-( <i>tert</i> -butylperoxy)butane (concentration ≤ 36%), with diluent Type B, see                 | –  | 5.2   | 3115   |
| <i>tert</i> -Butyl peroxy-2-ethylhexanoate (concentration ≤ 32%, with diluent Type B), see  | –  | 5.2   | 3119   |
| <i>tert</i> -Butyl peroxy-2-ethylhexanoate (concentration > 32–52%, with diluent Type B), see   | –  | 5.2   | 3117   |
| <i>tert</i> -Butyl peroxy-2-ethylhexanoate (concentration ≤ 52%, with inert solid), see   | –  | 5.2   | 3118   |
| <i>tert</i> -Butyl peroxy-2-ethylhexanoate (concentration > 52–100%), see   | –  | 5.2   | 3113   |
| <i>tert</i> -Butyl peroxy-2-ethylhexylcarbonate (concentration ≤ 100%), see   | –  | 5.2   | 3105   |
| <i>tert</i> -Butyl peroxyisobutyrate (concentration ≤ 52%, with diluent Type B), see  | –  | 5.2   | 3115   |
| <i>tert</i> -Butyl peroxyisobutyrate (concentration > 52–77%, with diluent Type B), see   | –  | 5.2   | 3111   |
| <i>tert</i> -Butylperoxy isopropylcarbonate (concentration ≤ 62%, with diluent Type B), see   | –  | 5.2   | 3105   |
| <i>tert</i> -Butyl peroxy isopropyl carbonate (concentration ≤ 77%, with diluent Type A), see   | –  | 5.2   | 3103   |
| 1-(2- <i>tert</i> -Butylperoxyisopropyl)-3-isopropenylbenzene (concentration ≤ 42%, with inert solid), see  | –  | 5.2   | 3108   |
| 1-(2- <i>tert</i> -Butylperoxy isopropyl)-3-isopropenylbenzene (concentration ≤ 77%, with diluent Type A), see  | –  | 5.2   | 3105   |
| <i>tert</i> -Butyl peroxy-2-methylbenzoate (concentration ≤ 100%), see  | –  | 5.2   | 3103   |
| <i>tert</i> -Butyl peroxyneodecanoate (concentration ≤ 32%, with diluent Type A), see   | –  | 5.2   | 3119   |
| <i>tert</i> -Butyl peroxyneodecanoate (concentration ≤ 42%, as a stable dispersion in water (frozen)), see  | –  | 5.2   | 3118   |

## Index

| Substance, material or article  | MP | Class | UN No. |
|---|----|-------|--------|
| <i>tert</i> -Butyl peroxyneodecanoate (concentration $\leq$ 52%, as a stable dispersion in water), see  | –  | 5.2   | 3119   |
| <i>tert</i> -Butyl peroxyneodecanoate (concentration $\leq$ 77%, with diluent Type B), see              | –  | 5.2   | 3115   |
| <i>tert</i> -Butyl peroxyneodecanoate (concentration $>$ 77–100%), see                                  | –  | 5.2   | 3115   |
| <i>tert</i> -Butyl peroxyneohexanoate (concentration $\leq$ 42%, as a stable dispersion in water), see  | –  | 5.2   | 3117   |
| <i>tert</i> -Butyl peroxyneohexanoate (concentration $\leq$ 77%, with diluent Type A), see              | –  | 5.2   | 3115   |
| <i>tert</i> -Butyl peroxyneopentanoate, not more than 42% in diluent Type A                             | –  | 5.2   | 3119   |
| <i>tert</i> -Butyl peroxyneopentanoate (concentration $\leq$ 27%, with diluent Type B), see             | –  | 5.2   | 3119   |
| <i>tert</i> -Butyl peroxyneopentanoate (concentration $>$ 27–67%, with diluent Type B), see             | –  | 5.2   | 3115   |
| <i>tert</i> -Butyl peroxyneopentanoate (concentration $>$ 67–77%, with diluent Type A), see             | –  | 5.2   | 3113   |
| <i>tert</i> -Butyl peroxyneopentanoate (concentration $\leq$ 100%), see                                 | –  | 5.2   | 3106   |
| <i>tert</i> -Butyl peroxy-3,5,5-trimethylhexanoate (concentration $\leq$ 37%, with diluent Type B), see | –  | 5.2   | 3109   |
| <i>tert</i> -Butyl peroxy-3,5,5-trimethylhexanoate (concentration $>$ 37–100%), see                     | –  | 5.2   | 3105   |
| <i>tert</i> -Butyl peroxy-3,5,5-trimethylhexanoate (concentration $\leq$ 42%, with inert solid), see    | –  | 5.2   | 3106   |
| Butylphenols, liquid, N.O.S., see   | –  | 8     | 3145   |
| Butylphenols, solid, N.O.S., see  | –  | 8     | 2430   |
| Butylphosphoric acid, see   | –  | 8     | 1718   |
| BUTYL PROPIONATES   | –  | 3     | 1914   |
| Butyl thioalcohols, see   | –  | 3     | 2347   |
| BUTYL TOLUENES  | –  | 6.1   | 2667   |
| BUTYLTRICHLOROSILANE  | –  | 8     | 1747   |
| 5- <i>tert</i> -BUTYL-2,4,6-TRINITRO- <i>m</i> -XYLENE  | –  | 4.1   | 2956   |
| BUTYL VINYL ETHER, STABILIZED   | –  | 3     | 2352   |
| 1-Butyne, stabilized, see   | –  | 2.1   | 2452   |
| 2-Butyne, see   | –  | 3     | 1144   |
| 1,4-BUTYNE DIOL   | –  | 6.1   | 2716   |
| 2-Butyne-1,4-diol, see  | –  | 6.1   | 2716   |
| BUTYRALDEHYDE   | –  | 3     | 1129   |
| BUTYRALDOXIME   | –  | 3     | 2840   |
| BUTYRIC ACID  | –  | 8     | 2820   |
| BUTYRIC ANHYDRIDE   | –  | 8     | 2739   |
| Butyrene, see   | –  | 3     | 2710   |
| BUTYRONITRILE   | –  | 3     | 2411   |
| Butyryl chloride, see   | –  | 3     | 2353   |
| BUTYRYL CHLORIDE  | –  | 3     | 2353   |
| Cable cutters, explosive, see   | –  | 1.4S  | 0070   |

| Substance, material or article  | MP | Class | UN No. |
|---|----|-------|--------|
| CACODYLIC ACID  | –  | 6.1   | 1572   |
| CADMIUM COMPOUND  | –  | 6.1   | 2570   |
| Cadmium selenide, <i>see</i>  | –  | 6.1   | 2570   |
| Cadmium sulphide, <i>see</i>  | P  | 6.1   | 2570   |
| CAESIUM   | –  | 4.3   | 1407   |
| Caesium alloy, liquid, <i>see</i>   | –  | 4.3   | 1421   |
| Caesium amalgams, liquid, <i>see</i>  | –  | 4.3   | 1389   |
| Caesium amalgams, solid, <i>see</i>   | –  | 4.3   | 3401   |
| Caesium amide, <i>see</i>   | –  | 4.3   | 1390   |
| Caesium dispersions, <i>see</i>   | –  | 4.3   | 1391   |
| CAESIUM HYDROXIDE   | –  | 8     | 2682   |
| CAESIUM HYDROXIDE SOLUTION  | –  | 8     | 2681   |
| CAESIUM NITRATE   | –  | 5.1   | 1451   |
| Caesium powder, pyrophoric, <i>see</i>  | –  | 4.2   | 1383   |
| Caffeine, <i>see</i>  | –  | 6.1   | 1544   |
| Cajeputene, <i>see</i>  | P  | 3     | 2052   |
| CALCIUM   | –  | 4.3   | 1401   |
| Calcium alloy, non-pyrophoric, solid, <i>see</i>  | –  | 4.3   | 1393   |
| CALCIUM ALLOYS, PYROPHORIC  | –  | 4.2   | 1855   |
| Calcium amalgams, liquid, <i>see</i>  | –  | 4.3   | 1389   |
| Calcium amalgams, solid, <i>see</i>   | –  | 4.3   | 3402   |
| CALCIUM ARSENATE  | P  | 6.1   | 1573   |
| CALCIUM ARSENATE AND CALCIUM ARSENITE MIXTURE, SOLID  | P  | 6.1   | 1574   |
| Calcium bisulphite solution, <i>see</i>   | –  | 8     | 2693   |
| CALCIUM CARBIDE   | –  | 4.3   | 1402   |
| CALCIUM CHLORATE  | –  | 5.1   | 1452   |
| CALCIUM CHLORATE, AQUEOUS SOLUTION  | –  | 5.1   | 2429   |
| CALCIUM CHLORITE  | –  | 5.1   | 1453   |
| CALCIUM CYANAMIDE with more than 0.1% calcium carbide   | –  | 4.3   | 1403   |
| CALCIUM CYANIDE   | P  | 6.1   | 1575   |
| Calcium dispersions, <i>see</i>   | –  | 4.3   | 1391   |
| CALCIUM DITHIONITE  | –  | 4.2   | 1923   |
| CALCIUM HYDRIDE   | –  | 4.3   | 1404   |
| Calcium hydrogen sulphite solution, <i>see</i>  | –  | 8     | 2693   |
| CALCIUM HYDROSULPHITE   | –  | 4.2   | 1923   |
| CALCIUM HYPOCHLORITE, DRY with more than 39% available chlorine (8.8% available oxygen)               | P  | 5.1   | 1748   |
| CALCIUM HYPOCHLORITE, DRY, CORROSIVE with more than 39% available chlorine (8.8% available oxygen)    | P  | 5.1   | 3485   |
| CALCIUM HYPOCHLORITE, HYDRATED with not less than 5.5% but not more than 16% water                    | P  | 5.1   | 2880   |
| CALCIUM HYPOCHLORITE, HYDRATED MIXTURE, CORROSIVE with not less than 5.5% but not more than 16% water | P  | 5.1   | 3487   |
| CALCIUM HYPOCHLORITE, HYDRATED, CORROSIVE with not less than 5.5% but not more than 16% water         | P  | 5.1   | 3487   |



## Index

| Substance, material or article   | MP | Class | UN No. |
|--|----|-------|--------|
| CALCIUM HYPOCHLORITE, HYDRATED MIXTURE with not less than 5.5% but not more than 16% water                 | P  | 5.1   | 2880   |
| CALCIUM HYPOCHLORITE MIXTURE, DRY, CORROSIVE with more than 10% but not more than 39% available chlorine   | P  | 5.1   | 3486   |
| CALCIUM HYPOCHLORITE MIXTURE, DRY, CORROSIVE with more than 39% available chlorine (8.8% available oxygen) | P  | 5.1   | 3485   |
| CALCIUM HYPOCHLORITE MIXTURE, DRY with more than 10% but not more than 39% available chlorine              | P  | 5.1   | 2208   |
| CALCIUM HYPOCHLORITE MIXTURE, DRY with more than 39% available chlorine (8.8% available oxygen)            | P  | 5.1   | 1748   |
| CALCIUM MANGANESE SILICON  | –  | 4.3   | 2844   |
| Calcium naphthenate in solution, <i>see</i>  | P  | 9     | 3082   |
| CALCIUM NITRATE  | –  | 5.1   | 1454   |
| CALCIUM OXIDE  | –  | 8     | 1910   |
| CALCIUM PERCHLORATE  | –  | 5.1   | 1455   |
| CALCIUM PERMANGANATE   | –  | 5.1   | 1456   |
| CALCIUM PEROXIDE   | –  | 5.1   | 1457   |
| CALCIUM PHOSPHIDE  | –  | 4.3   | 1360   |
| CALCIUM, PYROPHORIC  | –  | 4.2   | 1855   |
| CALCIUM RESINATE   | –  | 4.1   | 1313   |
| CALCIUM RESINATE, FUSED  | –  | 4.1   | 1314   |
| Calcium selenate, <i>see</i>   | –  | 6.1   | 2630   |
| CALCIUM SILICIDE   | –  | 4.3   | 1405   |
| Calcium silicon, <i>see</i>  | –  | 4.3   | 1405   |
| Calcium superoxide, <i>see</i>   | –  | 5.1   | 1457   |
| 2-Camphanol, <i>see</i>  | –  | 4.1   | 1312   |
| 2-Camphanone, <i>see</i>   | –  | 4.1   | 2717   |
| Camphechlor, <i>see</i> ORGANOCHLORINE PESTICIDE   | P  | –     | –      |
| CAMPHOR OIL  | –  | 3     | 1130   |
| CAMPHOR, synthetic   | –  | 4.1   | 2717   |
| CAPACITOR, ASYMMETRIC (with an energy storage capacity greater than 0.3 Wh)                                | –  | 9     | 3508   |
| CAPACITOR, ELECTRIC DOUBLE LAYER (with an energy storage capacity greater than 0.3 Wh)                     | –  | 9     | 3499   |
| CAPROIC ACID   | –  | 8     | 2829   |
| Caproic aldehyde, <i>see</i>   | –  | 3     | 1207   |
| Caprylyl chloride, <i>see</i>  | –  | 8     | 3265   |
| CARBAMATE PESTICIDE, LIQUID, FLAMMABLE, TOXIC, flashpoint less than 23°C                                   | –  | 3     | 2758   |
| CARBAMATE PESTICIDE, LIQUID, TOXIC   | –  | 6.1   | 2992   |
| CARBAMATE PESTICIDE, LIQUID, TOXIC, FLAMMABLE, flashpoint not less than 23°C                               | –  | 6.1   | 2991   |
| CARBAMATE PESTICIDE, SOLID, TOXIC  | –  | 6.1   | 2757   |
| Carbanil, <i>see</i>   | –  | 6.1   | 2487   |
| Carbaryl, <i>see</i> CARBAMATE PESTICIDE   | P  | –     | –      |
| Carbendazim, <i>see</i> Note 1   | P  | –     | –      |

| Substance, material or article  | MP | Class | UN No. |
|---|----|-------|--------|
| Carbofuran, see CARBAMATE PESTICIDE   | P  | –     | –      |
| Carbolic acid, molten, see  | –  | 6.1   | 2312   |
| Carbolic acid, solid, see   | –  | 6.1   | 1671   |
| Carbolic acid solution, see   | –  | 6.1   | 2821   |
| CARBON, ACTIVATED   | –  | 4.2   | 1362   |
| CARBON, animal origin   | –  | 4.2   | 1361   |
| Carbon bisulphide, see  | –  | 3     | 1131   |
| Carbon black, see   | –  | 4.2   | 1361   |
| CARBON DIOXIDE  | –  | 2.2   | 1013   |
| Carbon dioxide and ethylene oxide mixture, see ETHYLENE OXIDE AND CARBON DIOXIDE MIXTURE      | –  | –     | –      |
| CARBON DIOXIDE, REFRIGERATED LIQUID   | –  | 2.2   | 2187   |
| CARBON DIOXIDE, SOLID   | –  | 9     | 1845   |
| CARBON DISULPHIDE   | –  | 3     | 1131   |
| Carbonic anhydride, see   | –  | 2.2   | 1013   |
| Carbonic anhydride, refrigerated liquid, see  | –  | 2.2   | 2187   |
| Carbonic anhydride, solid, see  | –  | 9     | 1845   |
| CARBON MONOXIDE, COMPRESSED   | –  | 2.3   | 1016   |
| Carbon oxisulphide, see   | –  | 2.3   | 2204   |
| Carbon oxyfluoride, see   | –  | 2.3   | 2417   |
| Carbon oxyfluoride, compressed, see   | –  | 2.3   | 2417   |
| Carbon oxysulphide, see   | –  | 2.3   | 2204   |
| Carbon paper, see   | –  | 4.2   | 1379   |
| CARBON TETRABROMIDE   | P  | 6.1   | 2516   |
| CARBON TETRACHLORIDE  | P  | 6.1   | 1846   |
| CARBON, vegetable origin  | –  | 4.2   | 1361   |
| Carbonyl chloride, see  | –  | 2.3   | 1076   |
| CARBONYL FLUORIDE   | –  | 2.3   | 2417   |
| CARBONYL SULPHIDE   | –  | 2.3   | 2204   |
| Carbophenothion, see ORGANOPHOSPHORUS PESTICIDE   | P  | –     | –      |
| Cargo transport unit under fumigation, see  | –  | 9     | 3359   |
| Cartap hydrochloride, see CARBAMATE PESTICIDE   | P  | –     | –      |
| Cartridge cases, see CASES, CARTRIDGE   | –  | –     | –      |
| Cartridges, actuating, for fire extinguisher or apparatus valve, see CARTRIDGES, POWER DEVICE | –  | –     | –      |
| Cartridges, explosive, see  | –  | 1.1D  | 0048   |
| CARTRIDGES, FLASH   | –  | 1.1G  | 0049   |
| CARTRIDGES, FLASH   | –  | 1.3G  | 0050   |
| CARTRIDGES FOR TOOLS, BLANK   | –  | 1.4S  | 0014   |
| CARTRIDGES FOR WEAPONS, BLANK   | –  | 1.1C  | 0326   |
| CARTRIDGES FOR WEAPONS, BLANK   | –  | 1.2C  | 0413   |
| CARTRIDGES FOR WEAPONS, BLANK   | –  | 1.3C  | 0327   |
| CARTRIDGES FOR WEAPONS, BLANK   | –  | 1.4C  | 0338   |
| CARTRIDGES FOR WEAPONS, BLANK   | –  | 1.4S  | 0014   |

## Index

| Substance, material or article                                       | MP       | Class | UN No. |
|--|----------|-------|--------|
| CARTRIDGES FOR WEAPONS, INERT PROJECTILE                             | –        | 1.2C  | 0328   |
| CARTRIDGES FOR WEAPONS, INERT PROJECTILE                             | –        | 1.3C  | 0417   |
| CARTRIDGES FOR WEAPONS, INERT PROJECTILE                             | –        | 1.4C  | 0339   |
| CARTRIDGES FOR WEAPONS, INERT PROJECTILE                             | –        | 1.4S  | 0012   |
| CARTRIDGES FOR WEAPONS with bursting charge                          | –        | 1.1E  | 0006   |
| CARTRIDGES FOR WEAPONS with bursting charge                          | –        | 1.1F  | 0005   |
| CARTRIDGES FOR WEAPONS with bursting charge                          | –        | 1.2E  | 0321   |
| CARTRIDGES FOR WEAPONS with bursting charge                          | –        | 1.2F  | 0007   |
| CARTRIDGES FOR WEAPONS with bursting charge                          | –        | 1.4E  | 0412   |
| CARTRIDGES FOR WEAPONS with bursting charge                          | –        | 1.4F  | 0348   |
| Cartridges, illuminating, <i>see</i> AMMUNITION, ILLUMINATING        | –        | –     | –      |
| CARTRIDGES, OIL WELL   | –        | 1.3C  | 0277   |
| CARTRIDGES, OIL WELL   | –        | 1.4C  | 0278   |
| CARTRIDGES, POWER DEVICE   | –        | 1.2C  | 0381   |
| CARTRIDGES, POWER DEVICE   | –        | 1.3C  | 0275   |
| CARTRIDGES, POWER DEVICE   | –        | 1.4C  | 0276   |
| CARTRIDGES, POWER DEVICE   | –        | 1.4S  | 0323   |
| CARTRIDGES, SIGNAL   | –        | 1.3G  | 0054   |
| CARTRIDGES, SIGNAL   | –        | 1.4G  | 0312   |
| CARTRIDGES, SIGNAL   | –        | 1.4S  | 0405   |
| CARTRIDGES, SMALL ARMS   | –        | 1.3C  | 0417   |
| CARTRIDGES, SMALL ARMS   | –        | 1.4C  | 0339   |
| CARTRIDGES, SMALL ARMS   | –        | 1.4S  | 0012   |
| CARTRIDGES, SMALL ARMS, BLANK  | –        | 1.3C  | 0327   |
| CARTRIDGES, SMALL ARMS, BLANK  | –        | 1.4C  | 0338   |
| CARTRIDGES, SMALL ARMS, BLANK  | –        | 1.4S  | 0014   |
| Cartridges, starter, jet engine, <i>see</i> CARTRIDGES, POWER DEVICE | –        | –     | –      |
| CASES, CARTRIDGE, EMPTY, WITH PRIMER                                 | –        | 1.4C  | 0379   |
| CASES, CARTRIDGE, EMPTY, WITH PRIMER                                 | –        | 1.4S  | 0055   |
| CASES, COMBUSTIBLE, EMPTY, WITHOUT PRIMER                            | –        | 1.3C  | 0447   |
| CASES, COMBUSTIBLE, EMPTY, WITHOUT PRIMER                            | –        | 1.4C  | 0446   |
| Casinghead gasoline, <i>see</i>                                      | <b>P</b> | 3     | 1203   |
| CASTOR BEANS   | –        | 9     | 2969   |
| CASTOR FLAKE   | –        | 9     | 2969   |
| CASTOR MEAL  | –        | 9     | 2969   |
| CASTOR POMACE  | –        | 9     | 2969   |
| CAUSTIC ALKALI LIQUID, N.O.S.  | –        | 8     | 1719   |
| Caustic potash solution, <i>see</i>                                  | –        | 8     | 1814   |
| Caustic potash, solid, <i>see</i>                                    | –        | 8     | 1813   |
| Caustic soda liquor, <i>see</i>                                      | –        | 8     | 1824   |
| Caustic soda, solid, <i>see</i>                                      | –        | 8     | 1823   |
| Caustic soda solution, <i>see</i>                                    | –        | 8     | 1824   |
| △ CELLS, CONTAINING METALLIC SODIUM OR SODIUM ALLOY                  | –        | 4.3   | 3292   |

| Substance, material or article  | MP | Class | UN No. |
|---|----|-------|--------|
| CELLULOID in block, rods, rolls, sheets, tubes, etc., except scrap                  | –  | 4.1   | 2000   |
| CELLULOID, SCRAP  | –  | 4.2   | 2002   |
| Cellulose nitrate solution, see   | –  | 3     | 2059   |
| Cellulose nitrate with alcohol, see   | –  | 4.1   | 2556   |
| Cellulose nitrate with plasticizing substance, see                                  | –  | 4.1   | 2557   |
| Cellulose nitrate with water, see   | –  | 4.1   | 2555   |
| Cement, liquid, see   | –  | 3     | 1133   |
| CERIUM, gritty powder   | –  | 4.3   | 3078   |
| CERIUM, ingots  | –  | 4.1   | 1333   |
| Cerium powder, pyrophoric, see  | –  | 4.2   | 1383   |
| CERIUM, rods  | –  | 4.1   | 1333   |
| CERIUM, slabs   | –  | 4.1   | 1333   |
| CERIUM, turnings  | –  | 4.3   | 3078   |
| Cer Mischmetall, see  | –  | 4.1   | 1323   |
| Cesium, see CAESIUM   | –  | –     | –      |
| Charcoal, activated, see  | –  | 4.2   | 1362   |
| Charcoal, non-activated, see  | –  | 4.2   | 1361   |
| CHARGES, BURSTING, PLASTICS BONDED  | –  | 1.1D  | 0457   |
| CHARGES, BURSTING, PLASTICS BONDED  | –  | 1.2D  | 0458   |
| CHARGES, BURSTING, PLASTICS BONDED  | –  | 1.4D  | 0459   |
| CHARGES, BURSTING, PLASTICS BONDED  | –  | 1.4S  | 0460   |
| CHARGES, DEMOLITION   | –  | 1.1D  | 0048   |
| CHARGES, DEPTH  | –  | 1.1D  | 0056   |
| Charges, expelling, explosive, for fire extinguishers, see CARTRIDGES, POWER DEVICE | –  | –     | –      |
| CHARGES, EXPLOSIVE, COMMERCIAL without detonator                                    | –  | 1.1D  | 0442   |
| CHARGES, EXPLOSIVE, COMMERCIAL without detonator                                    | –  | 1.2D  | 0443   |
| CHARGES, EXPLOSIVE, COMMERCIAL without detonator                                    | –  | 1.4D  | 0444   |
| CHARGES, EXPLOSIVE, COMMERCIAL without detonator                                    | –  | 1.4S  | 0445   |
| CHARGES, PROPELLING   | –  | 1.1C  | 0271   |
| CHARGES, PROPELLING   | –  | 1.2C  | 0415   |
| CHARGES, PROPELLING   | –  | 1.3C  | 0272   |
| CHARGES, PROPELLING   | –  | 1.4C  | 0491   |
| CHARGES, PROPELLING, FOR CANNON   | –  | 1.1C  | 0279   |
| CHARGES, PROPELLING, FOR CANNON   | –  | 1.2C  | 0414   |
| CHARGES, PROPELLING, FOR CANNON   | –  | 1.3C  | 0242   |
| CHARGES, SHAPED, FLEXIBLE, LINEAR   | –  | 1.1D  | 0288   |
| CHARGES, SHAPED, FLEXIBLE, LINEAR   | –  | 1.4D  | 0237   |
| CHARGES, SHAPED, without detonator  | –  | 1.1D  | 0059   |
| CHARGES, SHAPED, without detonator  | –  | 1.2D  | 0439   |
| CHARGES, SHAPED, without detonator  | –  | 1.4D  | 0440   |
| CHARGES, SHAPED, without detonator  | –  | 1.4S  | 0441   |
| CHARGES, SUPPLEMENTARY, EXPLOSIVE   | –  | 1.1D  | 0060   |

## Index

| Substance, material or article   | MP | Class | UN No. |
|--|----|-------|--------|
| CHEMICAL KIT   | –  | 9     | 3316   |
| CHEMICAL SAMPLE, TOXIC   | –  | 6.1   | 3315   |
| CHEMICAL UNDER PRESSURE, N.O.S.  | –  | 2.2   | 3500   |
| CHEMICAL UNDER PRESSURE, CORROSIVE, N.O.S.   | –  | 2.2   | 3503   |
| CHEMICAL UNDER PRESSURE, FLAMMABLE, N.O.S.   | –  | 2.1   | 3501   |
| CHEMICAL UNDER PRESSURE, FLAMMABLE, CORROSIVE, N.O.S.  | –  | 2.1   | 3505   |
| CHEMICAL UNDER PRESSURE, FLAMMABLE, TOXIC, N.O.S.  | –  | 2.1   | 3504   |
| CHEMICAL UNDER PRESSURE, TOXIC, N.O.S.   | –  | 2.2   | 3502   |
| Chile saltpetre, <i>see</i>  | –  | 5.1   | 1498   |
| Chinomethionat, <i>see</i> PESTICIDE, N.O.S.   | –  | –     | –      |
| CHLORAL, ANHYDROUS, STABILIZED   | –  | 6.1   | 2075   |
| CHLORATE AND BORATE MIXTURE  | –  | 5.1   | 1458   |
| CHLORATE AND MAGNESIUM CHLORIDE MIXTURE, SOLID   | –  | 5.1   | 1459   |
| CHLORATE AND MAGNESIUM CHLORIDE MIXTURE SOLUTION   | –  | 5.1   | 3407   |
| CHLORATES, INORGANIC, AQUEOUS SOLUTION, N.O.S.   | –  | 5.1   | 3210   |
| CHLORATES, INORGANIC, N.O.S.   | –  | 5.1   | 1461   |
| Chlordane, <i>see</i> ORGANOCHLORINE PESTICIDE   | P  | –     | –      |
| Chlordimeform, <i>see</i> ORGANOCHLORINE PESTICIDE   | –  | –     | –      |
| Chlordimeform hydrochloride, <i>see</i> ORGANOCHLORINE PESTICIDE   | –  | –     | –      |
| Chlorfenvinphos, <i>see</i> ORGANOPHOSPHORUS PESTICIDE   | P  | –     | –      |
| CHLORIC ACID, AQUEOUS SOLUTION with a concentration exceeding 10% (transport prohibited)                     | –  | –     | –      |
| CHLORIC ACID, AQUEOUS SOLUTION with not more than 10% chloric acid   | –  | 5.1   | 2626   |
| Chlorinated paraffins (C <sub>10</sub> –C <sub>13</sub> ), <i>see</i>  | P  | 9     | 3082   |
| Chlorinated paraffins (C <sub>14</sub> –C <sub>17</sub> ) with more than 1% shorter chain length, <i>see</i> | P  | 9     | 3082   |
| CHLORINE   | P  | 2.3   | 1017   |
| CHLORINE, ADSORBED   | –  | 2.3   | 3520   |
| Chlorine bromide, <i>see</i>   | –  | 2.3   | 2901   |
| Chlorine cyanide, stabilized, <i>see</i>   | P  | 2.3   | 1589   |
| CHLORINE PENTAFLUORIDE   | –  | 2.3   | 2548   |
| CHLORINE TRIFLUORIDE   | –  | 2.3   | 1749   |
| CHLORITES, INORGANIC, N.O.S.   | –  | 5.1   | 1462   |
| CHLORITE SOLUTION  | –  | 8     | 1908   |
| Chlormephos, <i>see</i> ORGANOPHOSPHORUS PESTICIDE   | P  | –     | –      |
| Chloroacetaldehyde, <i>see</i>   | –  | 6.1   | 2232   |
| CHLOROACETIC ACID, MOLTEN  | –  | 6.1   | 3250   |
| CHLOROACETIC ACID, SOLID   | –  | 6.1   | 1751   |
| CHLOROACETIC ACID SOLUTION   | –  | 6.1   | 1750   |
| CHLOROACETONE, STABILIZED  | P  | 6.1   | 1695   |
| CHLOROACETONITRILE   | –  | 6.1   | 2668   |
| CHLOROACETOPHENONE, LIQUID   | –  | 6.1   | 3416   |
| CHLOROACETOPHENONE, SOLID  | –  | 6.1   | 1697   |

| Substance, material or article   | MP | Class | UN No. |
|--|----|-------|--------|
| CHLOROACETYL CHLORIDE  | –  | 6.1   | 1752   |
| <i>para</i> -Chloro- <i>ortho</i> -aminophenol, <i>see</i>   | –  | 6.1   | 2673   |
| 2-Chloroaniline, <i>see</i>  | –  | 6.1   | 2019   |
| 3-Chloroaniline, <i>see</i>  | –  | 6.1   | 2019   |
| 4-Chloroaniline, <i>see</i>  | –  | 6.1   | 2018   |
| <i>meta</i> -Chloroaniline, <i>see</i>   | –  | 6.1   | 2019   |
| <i>ortho</i> -Chloroaniline, <i>see</i>  | –  | 6.1   | 2019   |
| <i>para</i> -Chloroaniline, <i>see</i>   | –  | 6.1   | 2018   |
| CHLOROANILINES, LIQUID   | –  | 6.1   | 2019   |
| CHLOROANILINES, SOLID  | –  | 6.1   | 2018   |
| CHLOROANISIDINES   | –  | 6.1   | 2233   |
| CHLOROBENZENE  | –  | 3     | 1134   |
| CHLOROBENZOTRIFLUORIDES  | –  | 3     | 2234   |
| CHLOROBENZYL CHLORIDES, LIQUID   | P  | 6.1   | 2235   |
| CHLOROBENZYL CHLORIDES, SOLID  | P  | 6.1   | 3427   |
| 1-Chloro-3-bromopropane, <i>see</i>  | –  | 6.1   | 2688   |
| 2-Chlorobutadiene-1,3, stabilized, <i>see</i>  | –  | 3     | 1991   |
| 1-Chlorobutane, <i>see</i>   | –  | 3     | 1127   |
| 2-Chlorobutane, <i>see</i>   | –  | 3     | 1127   |
| CHLOROBUTANES  | –  | 3     | 1127   |
| Chlorocarbonates, toxic, corrosive, flammable, n.o.s., <i>see</i>  | –  | 6.1   | 2742   |
| Chlorocarbonates, toxic, corrosive, n.o.s., <i>see</i>   | –  | 6.1   | 3277   |
| CHLOROCRESOLS, SOLID   | –  | 6.1   | 3437   |
| CHLOROCRESOLS SOLUTION   | –  | 6.1   | 2669   |
| 3-Chloro-4-diethylaminobenzenediazonium zinc chloride<br>(concentration 100%), <i>see</i>  | –  | 4.1   | 3226   |
| CHLORODIFLUOROBROMOMETHANE   | –  | 2.2   | 1974   |
| 1-CHLORO-1,1-DIFLUOROETHANE  | –  | 2.1   | 2517   |
| CHLORODIFLUOROMETHANE  | –  | 2.2   | 1018   |
| CHLORODIFLUOROMETHANE AND<br>CHLOROPENTAFLUOROETHANE MIXTURE with fixed boiling point,<br>with approximately 49% chlorodifluoromethane | –  | 2.2   | 1973   |
| 3-Chloro-1,2-dihydroxypropane, <i>see</i>  | –  | 6.1   | 2689   |
| Chlorodimethyl ether, <i>see</i>   | –  | 6.1   | 1239   |
| CHLORODINITROBENZENES, LIQUID  | P  | 6.1   | 1577   |
| CHLORODINITROBENZENES, SOLID   | P  | 6.1   | 3441   |
| 2-CHLOROETHANAL  | –  | 6.1   | 2232   |
| Chloroethane, <i>see</i>   | –  | 2.1   | 1037   |
| Chloroethane nitrile, <i>see</i>   | –  | 6.1   | 2668   |
| 2-Chloroethanol, <i>see</i>  | –  | 6.1   | 1135   |
| 2-Chloroethyl alcohol, <i>see</i>  | –  | 6.1   | 1135   |
| CHLOROFORM   | –  | 6.1   | 1888   |
| CHLOROFORMATES, TOXIC, CORROSIVE, FLAMMABLE, N.O.S.  | –  | 6.1   | 2742   |
| CHLOROFORMATES, TOXIC, CORROSIVE, N.O.S.   | –  | 6.1   | 3277   |



## Index

| Substance, material or article   | MP | Class | UN No. |
|--|----|-------|--------|
| Chloromethane, <i>see</i>  | –  | 2.1   | 1063   |
| 1-Chloro-3-methylbutane, <i>see</i>  | –  | 3     | 1107   |
| 2-Chloro-2-methylbutane, <i>see</i>  | –  | 3     | 1107   |
| CHLOROMETHYL CHLOROFORMATE   | –  | 6.1   | 2745   |
| Chloromethyl cyanide, <i>see</i>   | –  | 6.1   | 2668   |
| CHLOROMETHYL ETHYL ETHER   | –  | 3     | 2354   |
| Chloromethyl methyl ether, <i>see</i>  | –  | 6.1   | 1239   |
| Chloromethylphenols, solution, <i>see</i>  | –  | 6.1   | 2669   |
| Chloromethylphenols, solid, <i>see</i>   | –  | 6.1   | 3437   |
| 3-CHLORO-4-METHYLPHENYL ISOCYANATE, LIQUID   | –  | 6.1   | 2236   |
| 3-CHLORO-4-METHYLPHENYL ISOCYANATE, SOLID  | –  | 6.1   | 3428   |
| Chloromethylpropanes, <i>see</i>   | –  | 3     | 1127   |
| 3-Chloro-2-methylprop-1-ene, <i>see</i>  | –  | 3     | 2554   |
| CHLORONITROANILINES  | P  | 6.1   | 2237   |
| CHLORONITROBENZENES, LIQUID  | –  | 6.1   | 3409   |
| CHLORONITROBENZENES, SOLID   | –  | 6.1   | 1578   |
| 2-Chloro-6-nitrotoluene, <i>see Note 1</i>   | P  | –     | –      |
| CHLORONITROTOLUENES, LIQUID  | P  | 6.1   | 2433   |
| CHLORONITROTOLUENES, SOLID   | P  | 6.1   | 3457   |
| 1-Chlorooctane, <i>see</i>   | P  | 9     | 3082   |
| CHLOROPENTAFLUOROETHANE  | –  | 2.2   | 1020   |
| Chloropentanes, <i>see</i>   | –  | 3     | 1107   |
| 3-Chloroperoxybenzoic acid (concentration ≤ 57%, with inert solid and water), <i>see</i> | –  | 5.2   | 3106   |
| 3-Chloroperoxybenzoic acid (concentration > 57–86%, with inert solid), <i>see</i>        | –  | 5.2   | 3102   |
| 3-Chloroperoxybenzoic acid (concentration ≤ 77% with inert solid and water), <i>see</i>  | –  | 5.2   | 3106   |
| Chlorophacinone, <i>see</i> ORGANOCHLORINE PESTICIDE                                     | –  | –     | –      |
| CHLOROPHENOLATES, LIQUID   | –  | 8     | 2904   |
| CHLOROPHENOLATES, SOLID  | –  | 8     | 2905   |
| CHLOROPHENOLS, LIQUID  | –  | 6.1   | 2021   |
| CHLOROPHENOLS, SOLID   | –  | 6.1   | 2020   |
| CHLOROPHENYLTRICHLOROSILANE  | P  | 8     | 1753   |
| CHLOROPICRIN   | P  | 6.1   | 1580   |
| CHLOROPICRIN AND METHYL BROMIDE MIXTURE with more than 2% chloropicrin                   | –  | 2.3   | 1581   |
| CHLOROPICRIN AND METHYL CHLORIDE MIXTURE   | –  | 2.3   | 1582   |
| CHLOROPICRIN MIXTURE, N.O.S.   | –  | 6.1   | 1583   |
| CHLOROPLATINIC ACID, SOLID   | –  | 8     | 2507   |
| CHLOROPRENE, STABILIZED  | –  | 3     | 1991   |
| 1-CHLOROPROPANE  | –  | 3     | 1278   |
| 2-CHLOROPROPANE  | –  | 3     | 2356   |
| 3-Chloropropanediol-1,2, <i>see</i>  | –  | 6.1   | 2689   |

| Substance, material or article   | MP | Class | UN No. |
|--|----|-------|--------|
| 1-Chloro-2-propanol, <i>see</i>  | –  | 6.1   | 2611   |
| 3-CHLOROPROPANOL-1   | –  | 6.1   | 2849   |
| 2-CHLOROPROPENE  | –  | 3     | 2456   |
| 3-Chloropropene, <i>see</i>  | –  | 3     | 1100   |
| 3-Chloroprop-1-ene, <i>see</i>   | –  | 3     | 1100   |
| 2-CHLOROPROPIONIC ACID   | –  | 8     | 2511   |
| <i>alpha</i> -Chloropropionic acid, <i>see</i>   | –  | 8     | 2511   |
| 2-Chloropropylene, <i>see</i>  | –  | 3     | 2456   |
| <i>alpha</i> -Chloropropylene, <i>see</i>  | –  | 3     | 1100   |
| 2-CHLOROPYRIDINE   | –  | 6.1   | 2822   |
| CHLOROSILANES, CORROSIVE, FLAMMABLE, N.O.S.  | –  | 8     | 2986   |
| CHLOROSILANES, CORROSIVE, N.O.S.   | –  | 8     | 2987   |
| CHLOROSILANES, FLAMMABLE, CORROSIVE, N.O.S.  | –  | 3     | 2985   |
| CHLOROSILANES, TOXIC, CORROSIVE, FLAMMABLE, N.O.S.   | –  | 6.1   | 3362   |
| CHLOROSILANES, TOXIC, CORROSIVE, N.O.S.  | –  | 6.1   | 3361   |
| CHLOROSILANES, WATER-REACTIVE, FLAMMABLE, CORROSIVE, N.O.S.  | –  | 4.3   | 2988   |
| CHLOROSULPHONIC ACID (with or without sulphur trioxide)  | –  | 8     | 1754   |
| Chlorosulphuric acid, <i>see</i>   | –  | 6.1   | 1834   |
| 1-CHLORO-1,2,2,2-TETRAFLUOROETHANE   | –  | 2.2   | 1021   |
| <i>meta</i> -Chlorotoluene, <i>see</i>   | –  | 3     | 2238   |
| <i>ortho</i> -Chlorotoluene, <i>see</i>  | P  | 3     | 2238   |
| <i>para</i> -Chlorotoluene, <i>see</i>   | –  | 3     | 2238   |
| CHLOROTOLUENES   | –  | 3     | 2238   |
| 4-CHLORO- <i>o</i> -TOLUIDINE HYDROCHLORIDE, SOLID   | –  | 6.1   | 1579   |
| 4-CHLORO- <i>o</i> -TOLUIDINE HYDROCHLORIDE SOLUTION   | –  | 6.1   | 3410   |
| CHLOROTOLUIDINES, LIQUID   | –  | 6.1   | 3429   |
| CHLOROTOLUIDINES, SOLID  | –  | 6.1   | 2239   |
| 1-CHLORO-2,2,2-TRIFLUOROETHANE   | –  | 2.2   | 1983   |
| Chlorotrifluoroethylene, stabilized, <i>see</i>  | –  | 2.3   | 1082   |
| CHLOROTRIFLUOROMETHANE   | –  | 2.2   | 1022   |
| CHLOROTRIFLUOROMETHANE AND TRIFLUOROMETHANE AZEOTROPIC MIXTURE with approximately 60% chlorotrifluoromethane | –  | 2.2   | 2599   |
| 2-Chloro-5-trifluoromethylnitrobenzene, <i>see</i>   | P  | 6.1   | 2307   |
| Chlorovinyl acetate, <i>see</i>  | –  | 6.1   | 2589   |
| Chlorphacinone, <i>see</i> ORGANOCHLORINE PESTICIDE  | –  | –     | –      |
| Chlorpyrifos, <i>see</i> ORGANOPHOSPHORUS PESTICIDE  | P  | –     | –      |
| Chlorthiophos, <i>see</i> ORGANOPHOSPHORUS PESTICIDE   | P  | –     | –      |
| Chromic acid, solid, <i>see</i>  | –  | 5.1   | 1463   |
| CHROMIC ACID SOLUTION  | –  | 8     | 1755   |
| Chromic anhydride, <i>see</i>  | –  | 5.1   | 1463   |
| CHROMIC FLUORIDE, SOLID  | –  | 8     | 1756   |
| CHROMIC FLUORIDE SOLUTION  | –  | 8     | 1757   |

## Index

| Substance, material or article   | MP | Class | UN No. |
|--|----|-------|--------|
| Chromic nitrate, <i>see</i>  | –  | 5.1   | 2720   |
| Chromium(VI) dichloride dioxide, <i>see</i>  | –  | 8     | 1758   |
| Chromium(III) fluoride, solid, <i>see</i>  | –  | 8     | 1756   |
| Chromium fluoride, solid, <i>see</i>   | –  | 8     | 1756   |
| Chromium fluoride solution, <i>see</i>   | –  | 8     | 1757   |
| CHROMIUM NITRATE   | –  | 5.1   | 2720   |
| Chromium(III) nitrate, <i>see</i>  | –  | 5.1   | 2720   |
| CHROMIUM OXYCHLORIDE   | –  | 8     | 1758   |
| CHROMIUM TRIOXIDE, ANHYDROUS   | –  | 5.1   | 1463   |
| CHROMOSULPHURIC ACID   | –  | 8     | 2240   |
| Chromyl chloride, <i>see</i>   | –  | 8     | 1758   |
| Chrysotile, <i>see</i>   | –  | 9     | 2590   |
| Cinene, <i>see</i>   | P  | 3     | 2052   |
| Cinnamene, <i>see</i>  | –  | 3     | 2055   |
| Cinnamol, <i>see</i>   | –  | 3     | 2055   |
| CLINICAL WASTE, UNSPECIFIED, N.O.S.  | –  | 6.2   | 3291   |
| COAL GAS, COMPRESSED   | –  | 2.3   | 1023   |
| Coal tar, <i>see</i>   | P  | 9     | 3082   |
| COAL TAR DISTILLATES, FLAMMABLE  | –  | 3     | 1136   |
| Coal tar naphtha, <i>see</i>   | –  | 3     | 1268   |
| Coal tar oil, <i>see</i>   | –  | 3     | 1136   |
| COATING SOLUTION (includes surface treatments or coatings used for industrial purposes such as vehicle under-coating, drum or barrel lining) | –  | 3     | 1139   |
| COBALT DIHYDROXIDE POWDER, containing not less than 10% respirable particles   | P  | 6.1   | 3550   |
| COBALT NAPHTHENATES, POWDER  | –  | 4.1   | 2001   |
| COBALT RESINATE, PRECIPITATED  | –  | 4.1   | 1318   |
| Cocculus, <i>see</i>   | P  | 6.1   | 3172   |
| Coconitrile, <i>see</i>  | P  | 9     | 3082   |
| Collodion cottons (class 1), <i>see</i> NITROCELLULOSE   | –  | –     | –      |
| Collodion cotton with alcohol, <i>see</i>  | –  | 4.1   | 2556   |
| Collodion cotton with plasticizing substance, <i>see</i>   | –  | 4.1   | 2557   |
| Collodion cotton with water, <i>see</i>  | –  | 4.1   | 2555   |
| Collodion solution, <i>see</i>   | –  | 3     | 2059   |
| COMPONENTS, EXPLOSIVE TRAIN, N.O.S.  | –  | 1.1B  | 0461   |
| COMPONENTS, EXPLOSIVE TRAIN, N.O.S.  | –  | 1.2B  | 0382   |
| COMPONENTS, EXPLOSIVE TRAIN, N.O.S.  | –  | 1.4B  | 0383   |
| COMPONENTS, EXPLOSIVE TRAIN, N.O.S.  | –  | 1.4S  | 0384   |
| Composition B, <i>see</i>  | –  | 1.1D  | 0118   |
| COMPRESSED GAS, FLAMMABLE, N.O.S.  | –  | 2.1   | 1954   |
| COMPRESSED GAS, N.O.S.   | –  | 2.2   | 1956   |
| COMPRESSED GAS, OXIDIZING, N.O.S.  | –  | 2.2   | 3156   |
| COMPRESSED GAS, TOXIC, CORROSIVE, N.O.S.   | –  | 2.3   | 3304   |

| Substance, material or article  | MP | Class | UN No. |
|---|----|-------|--------|
| COMPRESSED GAS, TOXIC, FLAMMABLE, CORROSIVE, N.O.S.                               | –  | 2.3   | 3305   |
| COMPRESSED GAS, TOXIC, FLAMMABLE, N.O.S.  | –  | 2.3   | 1953   |
| COMPRESSED GAS, TOXIC, N.O.S.   | –  | 2.3   | 1955   |
| COMPRESSED GAS, TOXIC, OXIDIZING, CORROSIVE, N.O.S.                               | –  | 2.3   | 3306   |
| COMPRESSED GAS, TOXIC, OXIDIZING, N.O.S.  | –  | 2.3   | 3303   |
| Container under fumigation, see   | –  | 9     | 3359   |
| CONTRIVANCES, WATER-ACTIVATED with burster, expelling charge or propelling charge | –  | 1.2L  | 0248   |
| CONTRIVANCES, WATER-ACTIVATED with burster, expelling charge or propelling charge | –  | 1.3L  | 0249   |
| COPPER ACETOARSENITE  | P  | 6.1   | 1585   |
| Copper arsenate, see  | –  | 6.1   | 1557   |
| COPPER ARSENITE   | P  | 6.1   | 1586   |
| Copper(II) arsenite, see  | –  | 6.1   | 1586   |
| COPPER BASED PESTICIDE, LIQUID, TOXIC   | –  | 6.1   | 3010   |
| COPPER BASED PESTICIDE, LIQUID, FLAMMABLE, TOXIC, flashpoint less than 23°C       | –  | 3     | 2776   |
| COPPER BASED PESTICIDE, LIQUID, TOXIC, FLAMMABLE, flashpoint not less than 23°C   | –  | 6.1   | 3009   |
| COPPER BASED PESTICIDE, SOLID, TOXIC  | –  | 6.1   | 2775   |
| COPPER CHLORATE   | –  | 5.1   | 2721   |
| Copper(II) chlorate, see  | –  | 5.1   | 2721   |
| COPPER CHLORIDE   | P  | 8     | 2802   |
| Copper compounds, see COPPER BASED PESTICIDE                                      | –  | –     | –      |
| COPPER CYANIDE  | P  | 6.1   | 1587   |
| Copper metal powder, see Note 1   | P  | –     | –      |
| Copper sulphate, anhydrous, hydrates and solutions, see Note 1                    | P  | –     | –      |
| COPRA   | –  | 4.2   | 1363   |
| CORD, DETONATING, flexible  | –  | 1.1D  | 0065   |
| CORD, DETONATING, flexible  | –  | 1.4D  | 0289   |
| CORD, DETONATING, metal-clad  | –  | 1.1D  | 0290   |
| CORD, DETONATING, metal-clad  | –  | 1.2D  | 0102   |
| CORD, DETONATING, MILD EFFECT, metal-clad   | –  | 1.4D  | 0104   |
| CORD, IGNITER   | –  | 1.4G  | 0066   |
| Cordite, see POWDER, SMOKELESS  | –  | –     | –      |
| CORROSIVE LIQUID, ACIDIC, INORGANIC, N.O.S.                                       | –  | 8     | 3264   |
| CORROSIVE LIQUID, ACIDIC, ORGANIC, N.O.S.   | –  | 8     | 3265   |
| CORROSIVE LIQUID, BASIC, INORGANIC, N.O.S.  | –  | 8     | 3266   |
| CORROSIVE LIQUID, BASIC, ORGANIC, N.O.S.  | –  | 8     | 3267   |
| CORROSIVE LIQUID, FLAMMABLE, N.O.S.   | –  | 8     | 2920   |
| CORROSIVE LIQUID, N.O.S.  | –  | 8     | 1760   |
| CORROSIVE LIQUID, OXIDIZING, N.O.S.   | –  | 8     | 3093   |
| CORROSIVE LIQUID, SELF-HEATING, N.O.S.  | –  | 8     | 3301   |
| CORROSIVE LIQUID, TOXIC, N.O.S.   | –  | 8     | 2922   |

## Index

| Substance, material or article   | MP | Class | UN No. |
|--|----|-------|--------|
| CORROSIVE LIQUID, WATER-REACTIVE, N.O.S.   | –  | 8     | 3094   |
| CORROSIVE SOLID, ACIDIC, INORGANIC, N.O.S.   | –  | 8     | 3260   |
| CORROSIVE SOLID, ACIDIC, ORGANIC, N.O.S.   | –  | 8     | 3261   |
| CORROSIVE SOLID, BASIC, INORGANIC, N.O.S.  | –  | 8     | 3262   |
| CORROSIVE SOLID, BASIC, ORGANIC, N.O.S.  | –  | 8     | 3263   |
| CORROSIVE SOLID, FLAMMABLE, N.O.S.   | –  | 8     | 2921   |
| CORROSIVE SOLID, N.O.S.  | –  | 8     | 1759   |
| CORROSIVE SOLID, OXIDIZING, N.O.S.   | –  | 8     | 3084   |
| CORROSIVE SOLID, SELF-HEATING, N.O.S.  | –  | 8     | 3095   |
| CORROSIVE SOLID, TOXIC, N.O.S.   | –  | 8     | 2923   |
| CORROSIVE SOLID, WATER-REACTIVE, N.O.S.  | –  | 8     | 3096   |
| Cosmetics, <i>see</i>  | –  | 3     | 1266   |
| Cotton, dry, <i>see</i>  | –  | 4.1   | 3360   |
| COTTON WASTE, OILY   | –  | 4.2   | 1364   |
| COTTON, WET  | –  | 4.2   | 1365   |
| Coumachlor, <i>see</i> COUMARIN DERIVATIVE PESTICIDE                                     | P  | –     | –      |
| Coumafuryl, <i>see</i> COUMARIN DERIVATIVE PESTICIDE                                     | –  | –     | –      |
| Coumaphos, <i>see</i> COUMARIN DERIVATIVE PESTICIDE                                      | P  | –     | –      |
| COUMARIN DERIVATIVE PESTICIDE, LIQUID, FLAMMABLE, TOXIC<br>flashpoint less than 23°C     | –  | 3     | 3024   |
| COUMARIN DERIVATIVE PESTICIDE, LIQUID, TOXIC   | –  | 6.1   | 3026   |
| COUMARIN DERIVATIVE PESTICIDE, LIQUID, TOXIC, FLAMMABLE<br>flashpoint not less than 23°C | –  | 6.1   | 3025   |
| COUMARIN DERIVATIVE PESTICIDE, SOLID, TOXIC  | –  | 6.1   | 3027   |
| Coumatetralyl, <i>see</i> COUMARIN DERIVATIVE PESTICIDE                                  | –  | –     | –      |
| Creosote, <i>see</i>   | P  | 9     | 3082   |
| Creosote salts, <i>see</i>   | P  | 4.1   | 1334   |
| CRESOLS, LIQUID  | –  | 6.1   | 2076   |
| CRESOLS, SOLID   | –  | 6.1   | 3455   |
| Cresyl diphenyl phosphate, <i>see</i>  | P  | 9     | 3082   |
| CRESYLIC ACID  | –  | 6.1   | 2022   |
| Crimidine, <i>see</i> ORGANOCHLORINE PESTICIDE   | –  | –     | –      |
| Crocidolite, <i>see</i>  | –  | 9     | 2212   |
| CROTONALDEHYDE   | P  | 6.1   | 1143   |
| CROTONALDEHYDE, STABILIZED   | P  | 6.1   | 1143   |
| CROTONIC ACID, LIQUID  | –  | 8     | 3472   |
| CROTONIC ACID, SOLID   | –  | 8     | 2823   |
| Crotonic aldehyde, stabilized, <i>see</i>  | P  | 6.1   | 1143   |
| CROTONYLENE  | –  | 3     | 1144   |
| Crotoxphos, <i>see</i> ORGANOPHOSPHORUS PESTICIDE  | P  | –     | –      |
| Crude naphtha, <i>see</i>  | –  | 3     | 1268   |
| Crufomate, <i>see</i> ORGANOPHOSPHORUS PESTICIDE   | –  | –     | –      |
| Cumene, <i>see</i>   | –  | 3     | 1918   |
| Cumyl hydroperoxide (concentration ≤ 90%, with diluent Type A), <i>see</i>               | –  | 5.2   | 3109   |

| Substance, material or article   | MP | Class | UN No. |
|--|----|-------|--------|
| Cumyl hydroperoxide (concentration > 90–98%, with diluent Type A),<br>see              | –  | 5.2   | 3107   |
| Cumyl peroxyneodecanoate (concentration ≤ 52% as a stable<br>dispersion in water), see | –  | 5.2   | 3119   |
| Cumyl peroxyneodecanoate (concentration ≤ 77%, with diluent<br>Type B), see            | –  | 5.2   | 3115   |
| Cumyl peroxyneodecanoate (concentration ≤ 87%, with diluent<br>Type A), see            | –  | 5.2   | 3115   |
| Cumyl peroxyneoheptanoate (concentration ≤ 77%, with diluent<br>Type A), see           | –  | 5.2   | 3115   |
| Cumyl peroxyneopivalate (concentration ≤ 77%, with diluent Type B), see                | –  | 5.2   | 3115   |
| Cupric arsenite, see   | P  | 6.1   | 1586   |
| Cupric chlorate, see   | –  | 5.1   | 2721   |
| Cupric chloride, see   | P  | 8     | 2802   |
| Cupric cyanide, see  | P  | 6.1   | 1587   |
| Cupric sulphate, see <b>Note 1</b>   | P  | –     | –      |
| CUPRIETHYLENEDIAMINE SOLUTION  | P  | 8     | 1761   |
| Cuprous chloride, see  | P  | 8     | 2802   |
| Cut-backs, see   | –  | 3     | 1999   |
| CUTTERS, CABLE, EXPLOSIVE  | –  | 1.4S  | 0070   |
| Cyanazine, see TRIAZINE PESTICIDE  | –  | –     | –      |
| Cyanide mixture, inorganic, solid, N.O.S., see   | P  | 6.1   | 1588   |
| CYANIDES, INORGANIC, SOLID, N.O.S.   | P  | 6.1   | 1588   |
| CYANIDE SOLUTION, N.O.S.   | P  | 6.1   | 1935   |
| Cyanides, organic, flammable, toxic, N.O.S., see                                       | –  | 3     | 3273   |
| Cyanides, organic, toxic, flammable, N.O.S., see                                       | –  | 6.1   | 3275   |
| Cyanides, organic, toxic, N.O.S., see  | –  | 6.1   | 3276   |
| Cyanoacetonitrile, see   | –  | 6.1   | 2647   |
| CYANOGEN   | –  | 2.3   | 1026   |
| CYANOGEN BROMIDE   | P  | 6.1   | 1889   |
| CYANOGEN CHLORIDE, STABILIZED  | P  | 2.3   | 1589   |
| Cyanophos, see ORGANOPHOSPHORUS PESTICIDE  | P  | –     | –      |
| CYANURIC CHLORIDE  | –  | 8     | 2670   |
| CYCLOBUTANE  | –  | 2.1   | 2601   |
| CYCLOBUTYL CHLOROFORMATE   | –  | 6.1   | 2744   |
| 1,5,9-CYCLODODECATRIENE  | P  | 6.1   | 2518   |
| CYCLOHEPTANE   | P  | 3     | 2241   |
| CYCLOHEPTATRIENE   | –  | 3     | 2603   |
| 1,3,5-Cycloheptatriene, see  | –  | 3     | 2603   |
| CYCLOHEPTENE   | –  | 3     | 2242   |
| 1,4-Cyclohexadienedione, see   | –  | 6.1   | 2587   |
| CYCLOHEXANE  | –  | 3     | 1145   |
| CYCLOHEXANETHIOL   | –  | 3     | 3054   |
| CYCLOHEXANONE  | –  | 3     | 1915   |



## Index

| Substance, material or article  | MP | Class | UN No. |
|---|----|-------|--------|
| Cyclohexanone peroxide(s) (concentration $\leq$ 32%, with inert solid) (exempt)   | –  | –     | –      |
| Cyclohexanone peroxide(s) (concentration $\leq$ 72%, as a paste, with diluent Type A, with or without water, available oxygen $\leq$ 9%), see | –  | 5.2   | 3106   |
| Cyclohexanone peroxide(s) (concentration $\leq$ 72%, with diluent Type A, available oxygen $\leq$ 9%), see                                    | –  | 5.2   | 3105   |
| Cyclohexanone peroxide(s) (concentration $\leq$ 91%, with water), see   | –  | 5.2   | 3104   |
| CYCLOHEXENE   | –  | 3     | 2256   |
| CYCLOHEXENYLTRICHLOROSILANE   | –  | 8     | 1762   |
| Cycloheximide, see PESTICIDE, N.O.S.  | –  | –     | –      |
| CYCLOHEXYL ACETATE  | –  | 3     | 2243   |
| CYCLOHEXYLAMINE   | –  | 8     | 2357   |
| CYCLOHEXYL ISOCYANATE   | –  | 6.1   | 2488   |
| CYCLOHEXYL MERCAPTAN  | –  | 3     | 3054   |
| CYCLOHEXYLTRICHLOROSILANE   | –  | 8     | 1763   |
| CYCLONITE AND CYCLOTETRAMETHYLENETETRANITRAMINE MIXTURE, DESENSITIZED with not less than 10% phlegmatizer, by mass                            | –  | 1.1D  | 0391   |
| CYCLONITE AND CYCLOTETRAMETHYLENETETRANITRAMINE MIXTURE, WETTED with not less than 15% water, by mass   | –  | 1.1D  | 0391   |
| CYCLONITE AND HMX MIXTURE, DESENSITIZED with not less than 10% phlegmatizer, by mass  | –  | 1.1D  | 0391   |
| CYCLONITE AND HMX MIXTURE, WETTED with not less than 15% water, by mass   | –  | 1.1D  | 0391   |
| CYCLONITE AND OCTOGEN MIXTURE, DESENSITIZED with not less than 10% phlegmatizer, by mass  | –  | 1.1D  | 0391   |
| CYCLONITE AND OCTOGEN MIXTURE, WETTED with not less than 15% water, by mass   | –  | 1.1D  | 0391   |
| CYCLONITE, DESENSITIZED   | –  | 1.1D  | 0483   |
| CYCLONITE, WETTED with not less than 15% water, by mass   | –  | 1.1D  | 0072   |
| CYCLOOCTADIENEPHOSPHINES  | –  | 4.2   | 2940   |
| CYCLOOCTADIENES   | –  | 3     | 2520   |
| CYCLOOCTATETRAENE   | –  | 3     | 2358   |
| CYCLOPENTANE  | –  | 3     | 1146   |
| CYCLOPENTANOL   | –  | 3     | 2244   |
| CYCLOPENTANONE  | –  | 3     | 2245   |
| CYCLOPENTENE  | –  | 3     | 2246   |
| CYCLOPROPANE  | –  | 2.1   | 1027   |
| CYCLOTETRAMETHYLENETETRANITRAMINE, DESENSITIZED   | –  | 1.1D  | 0484   |
| CYCLOTETRAMETHYLENETETRANITRAMINE, WETTED with not less than 15% water, by mass   | –  | 1.1D  | 0226   |
| CYCLOTRIMETHYLENETRINITRAMINE AND CYCLOTETRAMETHYLENETETRANITRAMINE MIXTURE, DESENSITIZED with not less than 10% phlegmatizer, by mass        | –  | 1.1D  | 0391   |
| CYCLOTRIMETHYLENETRINITRAMINE AND CYCLOTETRAMETHYLENETETRANITRAMINE MIXTURE, WETTED with not less than 15% water, by mass                     | –  | 1.1D  | 0391   |

| Substance, material or article   | MP | Class | UN No. |
|--|----|-------|--------|
| CYCLOTRIMETHYLENETRINITRAMINE AND HMX MIXTURE, DESENSITIZED with not less than 10% phlegmatizer, by mass                                 | –  | 1.1D  | 0391   |
| CYCLOTRIMETHYLENETRINITRAMINE AND HMX MIXTURE, WETTED with not less than 15% water, by mass  | –  | 1.1D  | 0391   |
| CYCLOTRIMETHYLENETRINITRAMINE AND OCTOGEN MIXTURE, DESENSITIZED with not less than 10% phlegmatizer, by mass                             | –  | 1.1D  | 0391   |
| CYCLOTRIMETHYLENETRINITRAMINE AND OCTOGEN MIXTURE, WETTED with not less than 15% water, by mass  | –  | 1.1D  | 0391   |
| CYCLOTRIMETHYLENETRINITRAMINE, DESENSITIZED  | –  | 1.1D  | 0483   |
| CYCLOTRIMETHYLENETRINITRAMINE, WETTED with not less than 15% water, by mass  | –  | 1.1D  | 0072   |
| Cyhexatin, <i>see</i> ORGANOTIN PESTICIDE  | P  | –     | –      |
| CYMENES  | P  | 3     | 2046   |
| Cymol, <i>see</i>  | P  | 3     | 2046   |
| Cypermethrin, <i>see</i> PYRETHROID PESTICIDE  | P  | –     | –      |
| 2,4-D, <i>see</i> PHENOXYACETIC ACID DERIVATIVE PESTICIDE  | –  | –     | –      |
| DANGEROUS GOODS IN ARTICLES  | –  | 9     | 3363   |
| DANGEROUS GOODS IN APPARATUS   | –  | 9     | 3363   |
| DANGEROUS GOODS IN MACHINERY   | –  | 9     | 3363   |
| Dazomet, <i>see</i> PESTICIDE, N.O.S.  | –  | –     | –      |
| 2,4-DB, <i>see</i> PHENOXYACETIC ACID DERIVATIVE PESTICIDE   | –  | –     | –      |
| DDT, <i>see</i> ORGANOCHLORINE PESTICIDE   | P  | –     | –      |
| Deanol, <i>see</i>   | –  | 8     | 2051   |
| DECABORANE   | –  | 4.1   | 1868   |
| DECAHYDRONAPHTHALENES  | –  | 3     | 1147   |
| Decaldehyde, <i>see</i>  | P  | 9     | 3082   |
| Decalin, <i>see</i>  | –  | 3     | 1147   |
| ([3R-(3R,5aS,6S,8aS,9R,10R,12S,12aR**)]-Decahydro-10-methoxy-3,6,9-trimethyl-3,12-epoxy-12H-pyrano[4,3-j]-1,2-benzodioxepin), <i>see</i> | –  | 5.2   | 3106   |
| <i>n</i> -DECANE   | –  | 3     | 2247   |
| Decyl acrylate, <i>see</i>   | P  | 9     | 3082   |
| Decyloxytetrahydrothiophene dioxide, <i>see</i> <b>Note 1</b>  | P  | –     | –      |
| DEF, <i>see</i> ORGANOPHOSPHORUS PESTICIDE   | P  | –     | –      |
| DEFLAGRATING METAL SALTS OF AROMATIC NITRO-DERIVATIVES, N.O.S.   | –  | 1.3C  | 0132   |
| Demephion, <i>see</i> ORGANOPHOSPHORUS PESTICIDE   | –  | –     | –      |
| Demeton, <i>see</i> ORGANOPHOSPHORUS PESTICIDE   | –  | –     | –      |
| Demeton-O, <i>see</i> ORGANOPHOSPHORUS PESTICIDE   | –  | –     | –      |
| Demeton-O-methyl, thiono isomer, <i>see</i> ORGANOPHOSPHORUS PESTICIDE   | –  | –     | –      |
| Demeton-S-methyl, <i>see</i> ORGANOPHOSPHORUS PESTICIDE  | –  | –     | –      |
| Demeton-S-methylsulphoxyd, <i>see</i> ORGANOPHOSPHORUS PESTICIDE   | –  | –     | –      |
| Depth charges, <i>see</i>  | –  | 1.1D  | 0056   |

## Index

| Substance, material or article   | MP | Class | UN No. |
|--|----|-------|--------|
| DESENSITIZED EXPLOSIVE, LIQUID, N.O.S.   | –  | 3     | 3379   |
| DESENSITIZED EXPLOSIVE, SOLID, N.O.S.  | –  | 4.1   | 3380   |
| Desmedipham, <i>see</i> Note 1   | P  | –     | –      |
| Detonating relays, <i>see</i> DETONATOR ASSEMBLIES,<br>NON-ELECTRIC, for blasting <i>or see</i> DETONATORS,<br>NON-ELECTRIC for blasting                             | –  | –     | –      |
| DETONATOR ASSEMBLIES, NON-ELECTRIC for blasting  | –  | 1.1B  | 0360   |
| DETONATOR ASSEMBLIES, NON-ELECTRIC for blasting  | –  | 1.4B  | 0361   |
| DETONATOR ASSEMBLIES, NON-ELECTRIC for blasting  | –  | 1.4S  | 0500   |
| DETONATORS, ELECTRIC for blasting  | –  | 1.1B  | 0030   |
| DETONATORS, ELECTRIC for blasting  | –  | 1.4B  | 0255   |
| DETONATORS, ELECTRIC for blasting  | –  | 1.4S  | 0456   |
| DETONATORS, ELECTRONIC programmable for blasting   | –  | 1.1B  | 0511   |
| DETONATORS, ELECTRONIC programmable for blasting   | –  | 1.4B  | 0512   |
| DETONATORS, ELECTRONIC programmable for blasting   | –  | 1.4S  | 0513   |
| DETONATORS FOR AMMUNITION  | –  | 1.1B  | 0073   |
| DETONATORS FOR AMMUNITION  | –  | 1.2B  | 0364   |
| DETONATORS FOR AMMUNITION  | –  | 1.4B  | 0365   |
| DETONATORS FOR AMMUNITION  | –  | 1.4S  | 0366   |
| DETONATORS, NON-ELECTRIC for blasting  | –  | 1.1B  | 0029   |
| DETONATORS, NON-ELECTRIC for blasting  | –  | 1.4B  | 0267   |
| DETONATORS, NON-ELECTRIC for blasting  | –  | 1.4S  | 0455   |
| DEUTERIUM, COMPRESSED  | –  | 2.1   | 1957   |
| DEVICES, SMALL, HYDROCARBON GAS POWERED  | –  | 2.1   | 3150   |
| Diacetone, <i>see</i>  | –  | 3     | 1148   |
| DIACETONE ALCOHOL  | –  | 3     | 1148   |
| Diacetone alcohol peroxides (concentration $\leq 57\%$ , with diluent Type B<br>and water, hydrogen peroxide $\leq 9\%$ , available oxygen $\leq 10\%$ ), <i>see</i> | –  | 5.2   | 3115   |
| Diacetyl, <i>see</i>   | –  | 3     | 2346   |
| Diacetyl peroxide (concentration $\leq 27\%$ , with diluent Type B), <i>see</i>  | –  | 5.2   | 3115   |
| Dialifos, <i>see</i> ORGANOPHOSPHORUS PESTICIDE  | P  | –     | –      |
| Diallate, <i>see</i> PESTICIDE, N.O.S.   | P  | –     | –      |
| DIALLYLAMINE   | –  | 3     | 2359   |
| DIALLYL ETHER  | –  | 3     | 2360   |
| Diamine, aqueous solution, <i>see</i>  | –  | 6.1   | 3293   |
| Diaminobenzenes ( <i>ortho</i> -; <i>meta</i> -; <i>para</i> -), <i>see</i>  | –  | 6.1   | 1673   |
| 4,4'-DIAMINODIPHENYLMETHANE  | P  | 6.1   | 2651   |
| 1,2-Diaminoethane, <i>see</i>  | –  | 8     | 1604   |
| 1,6-Diaminohexane, solid, <i>see</i>   | –  | 8     | 2280   |
| 1,6-Diaminohexane solution, <i>see</i>   | –  | 8     | 1783   |
| Diaminopropylamine, <i>see</i>   | –  | 8     | 2269   |
| DI- <i>n</i> -AMYLAMINE  | –  | 3     | 2841   |
| Di- <i>tert</i> -amyl peroxide (concentration $\leq 100\%$ ), <i>see</i>   | –  | 5.2   | 3107   |

| Substance, material or article   | MP | Class | UN No. |
|--|----|-------|--------|
| 2,2-Di-( <i>tert</i> -amylperoxy)butane (concentration $\leq$ 57%, with diluent Type A)                    | –  | 5.2   | 3105   |
| 1,1-Di-( <i>tert</i> -amylperoxy)cyclohexane (concentration $\leq$ 82%, with diluent Type A), see          | –  | 5.2   | 3103   |
| Diazinon, see ORGANOPHOSPHORUS PESTICIDE   | P  | –     | –      |
| DIAZODINITROPHENOL, WETTED with not less than 40% water, or mixture of alcohol and water, by mass          | –  | 1.1A  | 0074   |
| 2-Diazo-1-naphthol-4-sulphonyl chloride (concentration 100%), see  | –  | 4.1   | 3222   |
| 2-Diazo-1-naphthol-5-sulphonyl chloride (concentration 100%), see  | –  | 4.1   | 3222   |
| 2-Diazo-1-naphtholsulphonic acid ester mixtures Type D (concentration < 100%), see                         | –  | 4.1   | 3226   |
| Dibenzopyridine, see   | –  | 6.1   | 2713   |
| ■ Dibenzoyl peroxide (concentration $\leq$ 42%, with diluant type A and water), see                        | –  | 5.2   | 3109   |
| Dibenzoyl peroxide (concentration $\leq$ 35%, with inert solid) (exempt)                                   | –  | –     | –      |
| Dibenzoyl peroxide (concentration > 35–52%, with inert solid), see   | –  | 5.2   | 3106   |
| Dibenzoyl peroxide (concentration > 36–42%, with diluent Type A and water), see                            | –  | 5.2   | 3107   |
| Dibenzoyl peroxide (concentration $\leq$ 42% as a stable dispersion in water), see                         | –  | 5.2   | 3109   |
| Dibenzoyl peroxide (concentration > 52–100%, with inert solid), see  | –  | 5.2   | 3102   |
| Dibenzoyl peroxide (concentration $\leq$ 52%, as a paste, with diluent Type A, with or without water), see | –  | 5.2   | 3108   |
| Dibenzoyl peroxide (concentration > 52–62%, as a paste, with diluent Type A, with or without water), see   | –  | 5.2   | 3106   |
| Dibenzoyl peroxide (concentration $\leq$ 56.5% as a paste, with water), see                                | –  | 5.2   | 3108   |
| Dibenzoyl peroxide (concentration $\leq$ 62%, with inert solid and water), see                             | –  | 5.2   | 3106   |
| Dibenzoyl peroxide (concentration $\leq$ 77%, with water), see   | –  | 5.2   | 3104   |
| Dibenzoyl peroxide (concentration > 77–94%, with water), see   | –  | 5.2   | 3102   |
| DIBENZYL DICHLOROSILANE  | –  | 8     | 2434   |
| DIBORANE   | –  | 2.3   | 1911   |
| 1,3-Dibromobenzene, see  | P  | 9     | 3082   |
| 1,2-DIBROMOBUTAN-3-ONE   | –  | 6.1   | 2648   |
| 1,2-Dibromo-3-chloropropane (pesticides), see DIBROMOCHLOROPROPANES  | –  | 6.1   | 2872   |
| DIBROMOCHLOROPROPANES  | –  | 6.1   | 2872   |
| DIBROMODIFLUOROMETHANE   | –  | 9     | 1941   |
| 1,2-Dibromoethane, see   | –  | 6.1   | 1605   |
| DIBROMOMETHANE   | –  | 6.1   | 2664   |
| 2,5-Dibutoxy-4-(4-morpholinyl)benzenediazonium tetrachlorozincate (2:1) (concentration 100%), see          | –  | 4.1   | 3228   |
| Di- <i>n</i> -BUTYLAMINE   | –  | 8     | 2248   |
| Dibutylaminoethanol, see   | –  | 6.1   | 2873   |
| 2-Dibutylaminoethanol, see   | –  | 6.1   | 2873   |
| DI-BUTYLAMINOETHANOL   | –  | 6.1   | 2873   |

## Index

| Substance, material or article  | MP | Class | UN No. |
|---|----|-------|--------|
| 1,4-Di- <i>tert</i> -butylbenzene, see  | P  | 9     | 3077   |
| Di-(4- <i>tert</i> -butylcyclohexyl) peroxydicarbonate (concentration ≤ 42%, as a paste), see   | –  | 5.2   | 3118   |
| Di-(4- <i>tert</i> -butylcyclohexyl) peroxydicarbonate (concentration ≤ 42%, as a stable dispersion in water), see                            | –  | 5.2   | 3119   |
| Di-(4- <i>tert</i> -butylcyclohexyl) peroxydicarbonate (concentration ≤ 100%), see  | –  | 5.2   | 3114   |
| DIBUTYL ETHERS  | –  | 3     | 1149   |
| Di- <i>normal</i> -butyl ketone, see  | P  | 3     | 1224   |
| Di- <i>tert</i> -butyl peroxide (concentration ≤ 52%, with diluent Type B), see   | –  | 5.2   | 3109   |
| Di- <i>tert</i> -butyl peroxide (concentration > 52–100%), see  | –  | 5.2   | 3107   |
| Di- <i>tert</i> -butyl peroxyazolate (concentration ≤ 52%, with diluent Type A), see  | –  | 5.2   | 3105   |
| 2,2-Di-( <i>tert</i> -butylperoxy)butane (concentration ≤ 52%, with diluent Type A), see  | –  | 5.2   | 3103   |
| 1,6-Di-( <i>tert</i> -butylperoxycarbonyloxy)hexane (concentration ≤ 72%, with diluent Type A), see   | –  | 5.2   | 3103   |
| 1,1-Di-( <i>tert</i> -butylperoxy)cyclohexane (concentration ≤ 13%, with diluents Type A and B), see  | –  | 5.2   | 3109   |
| 1,1-Di-( <i>tert</i> -butylperoxy)cyclohexane (concentration ≤ 27%, with diluent Type A), see   | –  | 5.2   | 3107   |
| 1,1-Di-( <i>tert</i> -butylperoxy)cyclohexane (concentration ≤ 42%, with diluent Type A), see   | –  | 5.2   | 3109   |
| 1,1-Di-( <i>tert</i> -butylperoxy)cyclohexane (concentration ≤ 42%, with diluent Type A and inert solid), see                                 | –  | 5.2   | 3106   |
| 1,1-Di-( <i>tert</i> -butylperoxy)cyclohexane (concentration > 42–52%, with diluent Type A)   | –  | 5.2   | 3105   |
| 1,1-Di-( <i>tert</i> -butylperoxy)cyclohexane (concentration > 52–80%, with diluent Type A), see  | –  | 5.2   | 3103   |
| 1,1-Di-( <i>tert</i> -butylperoxy)cyclohexane (concentration ≤ 72%, with diluent Type B), see   | –  | 5.2   | 3103   |
| 1,1-Di-( <i>tert</i> -butylperoxy)cyclohexane (concentration > 80–100%), see  | –  | 5.2   | 3101   |
| 1,1-Di-( <i>tert</i> -butylperoxy)cyclohexane + <i>tert</i> -butyl peroxy-2-ethylhexanoate (concentration ≤ 43% + ≤ 16%, with diluent Type A) | –  | 5.2   | 3105   |
| Di- <i>n</i> -butyl peroxydicarbonate (concentration ≤ 27%, with diluent Type B), see   | –  | 5.2   | 3117   |
| Di- <i>n</i> -butyl peroxydicarbonate (concentration > 27–52%, with diluent Type B), see  | –  | 5.2   | 3115   |
| Di- <i>n</i> -butyl peroxydicarbonate (concentration ≤ 42% as a stable dispersion in water (frozen)), see                                     | –  | 5.2   | 3118   |
| Di- <i>sec</i> -butyl peroxydicarbonate (concentration ≤ 52%, with diluent Type B), see   | –  | 5.2   | 3115   |
| Di- <i>sec</i> -butyl peroxydicarbonate (concentration > 52–100%), see  | –  | 5.2   | 3113   |
| Di-( <i>tert</i> -butylperoxyisopropyl)benzene(s) (concentration ≤ 42%, with inert solid) (exempt)  | –  | –     | –      |
| Di-( <i>tert</i> -butylperoxyisopropyl)benzene(s) (concentration > 42–100%, with inert solid), see  | –  | 5.2   | 3106   |
| Di-( <i>tert</i> -butylperoxy) phthalate (concentration ≤ 42%, with diluent Type A), see  | –  | 5.2   | 3107   |

| Substance, material or article  | MP | Class | UN No. |
|---|----|-------|--------|
| Di-( <i>tert</i> -butylperoxy) phthalate (concentration >42–52%, with diluent Type A), <i>see</i>                                 | –  | 5.2   | 3105   |
| Di-( <i>tert</i> -butylperoxy) phthalate (concentration ≤ 52%, as a paste with diluent Type A, with or without water), <i>see</i> | –  | 5.2   | 3106   |
| 2,2-Di-( <i>tert</i> -butylperoxy)propane (concentration ≤ 42%, with diluent Type A, with inert solid), <i>see</i>                | –  | 5.2   | 3106   |
| 2,2-Di-( <i>tert</i> -butylperoxy)propane (concentration ≤ 52% with diluent Type A), <i>see</i>                                   | –  | 5.2   | 3105   |
| 1,1-Di-( <i>tert</i> -butylperoxy)-3,3,5-trimethylcyclohexane (concentration ≤ 32%, with diluents Type A and B), <i>see</i>       | –  | 5.2   | 3107   |
| 1,1-Di-( <i>tert</i> -butylperoxy)-3,3,5-trimethylcyclohexane (concentration ≤ 57%, with diluent Type A), <i>see</i>              | –  | 5.2   | 3107   |
| 1,1-Di-( <i>tert</i> -butylperoxy)-3,3,5-trimethylcyclohexane (concentration ≤ 57%, with inert solid), <i>see</i>                 | –  | 5.2   | 3110   |
| 1,1-Di-( <i>tert</i> -butylperoxy)-3,3,5-trimethylcyclohexane (concentration >57–90%, with diluent Type A), <i>see</i>            | –  | 5.2   | 3103   |
| 1,1-Di-( <i>tert</i> -butylperoxy)-3,3,5-trimethylcyclohexane (concentration ≤ 77%, with diluent Type B), <i>see</i>              | –  | 5.2   | 3103   |
| 1,1-Di-( <i>tert</i> -butylperoxy)-3,3,5-trimethylcyclohexane (concentration ≤ 90%, with diluent Type B)                          | –  | 5.2   | 3103   |
| 1,1-Di-( <i>tert</i> -butylperoxy)-3,3,5-trimethylcyclohexane (concentration >90–100%), <i>see</i>                                | –  | 5.2   | 3101   |
| 2,4-Di- <i>tert</i> -butylphenol, <i>see</i> <b>Note 1</b>  | –  | –     | –      |
| 2,6-Di- <i>tert</i> -butylphenol, <i>see</i> <b>Note 1</b>  | –  | –     | –      |
| Di- <i>n</i> -butyl phthalate, <i>see</i>   | P  | 9     | 3082   |
| Dicetyl peroxydicarbonate (concentration ≤ 42% as a stable dispersion in water), <i>see</i>                                       | –  | 5.2   | 3119   |
| Dicetyl peroxydicarbonate (concentration ≤ 100%), <i>see</i>  | –  | 5.2   | 3120   |
| Dichlofenthion, <i>see</i> ORGANOPHOSPHORUS PESTICIDE   | P  | –     | –      |
| 1,1-DICHLORO-1-NITROETHANE  | –  | 6.1   | 2650   |
| DICHLOROACETIC ACID   | –  | 8     | 1764   |
| 1,3-DICHLOROACETONE   | –  | 6.1   | 2649   |
| DICHLOROACETYL CHLORIDE   | –  | 8     | 1765   |
| DICHLOROANILINES, LIQUID  | P  | 6.1   | 1590   |
| DICHLOROANILINES, SOLID   | P  | 6.1   | 3442   |
| 1,2-Dichlorobenzene, <i>see</i>   | –  | 6.1   | 1591   |
| 1,3-Dichlorobenzene, <i>see</i>   | P  | 6.1   | 2810   |
| 1,4-Dichlorobenzene, <i>see</i>   | P  | 9     | 3082   |
| <i>meta</i> -Dichlorobenzene, <i>see</i>  | P  | 6.1   | 2810   |
| <i>o</i> -DICHLOROBENZENE   | –  | 6.1   | 1591   |
| <i>para</i> -Dichlorobenzene, <i>see</i>  | P  | 9     | 3082   |
| Di-(4-chlorobenzoyl) peroxide (concentration ≤ 32%, with inert solid) ( <i>exempt</i> )   | –  | –     | –      |
| Di-4-chlorobenzoyl peroxide (concentration ≤ 52%, as a paste, with diluent Type A, with or without water), <i>see</i>             | –  | 5.2   | 3106   |
| Di-4-chlorobenzoyl peroxide (concentration ≤ 77%, with water), <i>see</i>   | –  | 5.2   | 3102   |
| 2,2'-DICHLORODIETHYL ETHER  | –  | 6.1   | 1916   |



## Index

| Substance, material or article  | MP | Class | UN No. |
|---|----|-------|--------|
| DICHLORODIFLUOROMETHANE   | –  | 2.2   | 1028   |
| DICHLORODIFLUOROMETHANE AND DIFLUOROETHANE<br>AZEOTROPIC MIXTURE with approximately 74%<br>dichloro-difluoromethane | –  | 2.2   | 2602   |
| Dichlorodifluoromethane and ethylene oxide mixture, <i>see</i>  | –  | 2.2   | 3070   |
| DICHLORODIMETHYL ETHER, SYMMETRICAL   | –  | 6.1   | 2249   |
| 1,1-DICHLOROETHANE  | –  | 3     | 2362   |
| 1,2-Dichloroethane, <i>see</i>  | –  | 3     | 1184   |
| 1,1-Dichloroethylene, stabilized, <i>see</i>  | P  | 3     | 1303   |
| 1,2-DICHLOROETHYLENE  | –  | 3     | 1150   |
| Di-(2-chloroethyl) ether, <i>see</i>  | –  | 6.1   | 1916   |
| DICHLOROFLUOROMETHANE   | –  | 2.2   | 1029   |
| 1,6-Dichlorohexane, <i>see</i>  | P  | 9     | 3082   |
| <i>alpha</i> -Dichlorohydrin, <i>see</i>  | –  | 6.1   | 2750   |
| DICHLOROISOCYANURIC ACID, DRY   | –  | 5.1   | 2465   |
| DICHLOROISOCYANURIC ACID SALTS  | –  | 5.1   | 2465   |
| Dichloroisopropyl alcohol, <i>see</i>   | –  | 6.1   | 2750   |
| DICHLOROISOPROPYL ETHER   | –  | 6.1   | 2490   |
| DICHLOROMETHANE   | –  | 6.1   | 1593   |
| DICHLOROPENTANES  | –  | 3     | 1152   |
| 2,4-Dichlorophenol, <i>see</i>  | P  | 6.1   | 2020   |
| Dichlorophenols, liquid, <i>see</i>   | –  | 6.1   | 2021   |
| Dichlorophenols, solid, <i>see</i>  | –  | 6.1   | 2020   |
| DICHLOROPHENYL ISOCYANATES  | –  | 6.1   | 2250   |
| DICHLOROPHENYLTRICHLOROSILANE   | P  | 8     | 1766   |
| 1,1-Dichloropropane, <i>see</i>   | –  | 3     | 1993   |
| 1,2-DICHLOROPROPANE   | –  | 3     | 1279   |
| 1,3-Dichloropropane, <i>see</i>   | –  | 3     | 1993   |
| 1,3-DICHLOROPROPANOL-2  | –  | 6.1   | 2750   |
| 1,3-Dichloro-2-propanone, <i>see</i>  | –  | 6.1   | 2649   |
| 1,3-Dichloropropene, <i>see</i>   | P  | 3     | 2047   |
| DICHLOROPROPENES  | –  | 3     | 2047   |
| DICHLOROSILANE  | –  | 2.3   | 2189   |
| 1,2-DICHLORO-1,1,2,2-TETRAFLUOROETHANE  | –  | 2.2   | 1958   |
| Dichloro- <i>s</i> -triazine-2,4,6-trione   | –  | 5.1   | 2465   |
| Dichlorvos, <i>see</i> ORGANOPHOSPHORUS PESTICIDE   | P  | –     | –      |
| Diclofop-methyl, <i>see</i> Note 1  | P  | –     | –      |
| Dicoumarol, <i>see</i> COUMARIN DERIVATIVE PESTICIDE  | –  | –     | –      |
| Dicrotophos, <i>see</i> ORGANOPHOSPHORUS PESTICIDE  | P  | –     | –      |
| Dicumyl peroxide (concentration ≤ 52%, with inert solid) (exempt)   | –  | –     | –      |
| Dicumyl peroxide (concentration > 52–100%), <i>see</i>  | –  | 5.2   | 3110   |
| 1,4-Dicyanobutane, <i>see</i>   | –  | 6.1   | 2205   |
| Dicyanogen, <i>see</i>  | –  | 2.3   | 1026   |
| Dicycloheptadiene, stabilized, <i>see</i>   | –  | 3     | 2251   |

| Substance, material or article  | MP | Class | UN No. |
|---|----|-------|--------|
| DICYCLOHEXYLAMINE   | –  | 8     | 2565   |
| Dicyclohexylamine nitrite, <i>see</i>   | –  | 4.1   | 2687   |
| DICYCLOHEXYLAMMONIUM NITRITE  | –  | 4.1   | 2687   |
| Dicyclohexyl peroxydicarbonate (concentration $\leq$ 42% as a stable dispersion in water), <i>see</i>                 | –  | 5.2   | 3119   |
| Dicyclohexyl peroxydicarbonate (concentration $\leq$ 91%, with water), <i>see</i>                                     | –  | 5.2   | 3114   |
| Dicyclohexyl peroxydicarbonate (concentration $>$ 91–100%), <i>see</i>  | –  | 5.2   | 3112   |
| DICYCLOPENTADIENE   | –  | 3     | 2048   |
| Didecanoyl peroxide (concentration $\leq$ 100%), <i>see</i>   | –  | 5.2   | 3114   |
| 2,2-Di-(4,4-di-( <i>tert</i> -butylperoxy)cyclohexyl)propane (concentration $\leq$ 22%, with water), <i>see</i>       | –  | 5.2   | 3107   |
| 2,2-Di-(4,4-di-( <i>tert</i> -butylperoxy)cyclohexyl)propane (concentration $\leq$ 42%, with inert solid), <i>see</i> | –  | 5.2   | 3106   |
| Di-2,4-dichlorobenzoyl peroxide (concentration $\leq$ 52%, as a paste)  | –  | 5.2   | 3118   |
| △ Di-(2,4-dichlorobenzoyl) peroxide (concentration $\leq$ 52%, as a paste, with silicon oil), <i>see</i>              | –  | 5.2   | 3104   |
| Di-(2,4-dichlorobenzoyl) peroxide (concentration $\leq$ 77%, with water), <i>see</i>                                  | –  | 5.2   | 3102   |
| 1,2-DI-(DIMETHYLAMINO)ETHANE  | –  | 3     | 2372   |
| DIDYMIUM NITRATE  | –  | 5.1   | 1465   |
| Dieldrin, <i>see</i> ORGANOCHLORINE PESTICIDE   | P  | –     | –      |
| DIESEL FUEL   | –  | 3     | 1202   |
| 1,1-Diethoxyethane, <i>see</i>  | –  | 3     | 1088   |
| 1,2-Diethoxyethane, <i>see</i>  | –  | 3     | 1153   |
| Di-(2-ethoxyethyl) peroxydicarbonate (concentration $\leq$ 52%, with diluent Type B), <i>see</i>                      | –  | 5.2   | 3115   |
| DIETHOXYMETHANE   | –  | 3     | 2373   |
| 2,5-Diethoxy-4-morpholinobenzenediazonium tetrafluoroborate (concentration 100%), <i>see</i>                          | –  | 4.1   | 3236   |
| 2,5-Diethoxy-4-morpholinobenzenediazonium zinc chloride (concentration 66%), <i>see</i>                               | –  | 4.1   | 3236   |
| 2,5-Diethoxy-4-morpholinobenzenediazonium zinc chloride (concentration 67–100%), <i>see</i>                           | –  | 4.1   | 3236   |
| 2,5-Diethoxy-4-(4-morpholinyl)benzenediazonium sulphate (concentration 100%), <i>see</i>                              | –  | 4.1   | 3226   |
| 2,5-Diethoxy-4-(phenylsulphonyl)benzenediazonium zinc chloride (concentration 67%), <i>see</i>                        | –  | 4.1   | 3236   |
| 3,3-DIETHOXYPROPENE   | –  | 3     | 2374   |
| Diethylacetaldehyde, <i>see</i>   | –  | 3     | 1178   |
| DIETHYLAMINE  | –  | 3     | 1154   |
| 1-Diethylamino-4-aminopentane, <i>see</i>   | –  | 6.1   | 2946   |
| Diethylaminoethanol, <i>see</i>   | –  | 8     | 2686   |
| 2-DIETHYLAMINOETHANOL   | –  | 8     | 2686   |
| 3-DIETHYLAMINOPROPYLAMINE   | –  | 3     | 2684   |
| <i>N,N</i> -DIETHYLANILINE  | –  | 6.1   | 2432   |
| DIETHYLBENZENES   | –  | 3     | 2049   |

## Index

| Substance, material or article   | MP | Class | UN No. |
|--|----|-------|--------|
| Diethyl carbinol, <i>see</i>   | –  | 3     | 1105   |
| DIETHYL CARBONATE  | –  | 3     | 2366   |
| DIETHYLDICHLOROSILANE  | –  | 8     | 1767   |
| Diethylenediamine, <i>see</i>  | –  | 8     | 2579   |
| Diethylenediamine, solid, <i>see</i>   | –  | 8     | 2579   |
| 1,4-Diethylene dioxide, <i>see</i>   | –  | 3     | 1165   |
| Diethyleneglycol bis(allyl carbonate) + di-isopropyl peroxydicarbonate (concentration $\geq 88\%$ + $\leq 12\%$ ), <i>see</i>  | –  | 4.1   | 3237   |
| DIETHYLENEGLYCOL DINITRATE, DESENSITIZED with not less than 25% non-volatile, water-insoluble phlegmatizer, by mass  | –  | 1.1D  | 0075   |
| Diethylene oxide, <i>see</i>   | –  | 3     | 1165   |
| DIETHYLENETRIAMINE   | –  | 8     | 2079   |
| <i>N,N</i> -Diethylethanolamine, <i>see</i>  | –  | 8     | 2686   |
| DIETHYL ETHER  | –  | 3     | 1155   |
| <i>N,N</i> -DIETHYLETHYLENEDIAMINE   | –  | 8     | 2685   |
| Diethyl formal, <i>see</i>   | –  | 3     | 2373   |
| Di-(2-ethylhexyl) peroxydicarbonate (concentration $\leq 52\%$ , as a stable dispersion in water (frozen)), <i>see</i>   | –  | 5.2   | 3120   |
| Di-(2-ethylhexyl) peroxydicarbonate (concentration $\leq 62\%$ , as a stable dispersion in water), <i>see</i>  | –  | 5.2   | 3119   |
| Di-(2-ethylhexyl) peroxydicarbonate (concentration $\leq 77\%$ , with diluent Type B), <i>see</i>  | –  | 5.2   | 3115   |
| Di-(2-ethylhexyl) peroxydicarbonate (concentration $> 77-100\%$ ), <i>see</i>  | –  | 5.2   | 3113   |
| Di-(2-ethylhexyl)phosphoric acid, <i>see</i>   | –  | 8     | 1902   |
| DIETHYL KETONE   | –  | 3     | 1156   |
| Diethyl oxalate, <i>see</i>  | –  | 6.1   | 2525   |
| <i>N,N</i> -Diethyl-1,3-propanediamine, <i>see</i>   | –  | 3     | 2684   |
| DIETHYL SULPHATE   | –  | 6.1   | 1594   |
| DIETHYL SULPHIDE   | –  | 3     | 2375   |
| DIETHYLTHIOPHOSPHORYL CHLORIDE   | –  | 8     | 2751   |
| Diethylzinc, <i>see</i>  | –  | 4.2   | 3394   |
| Difenacoum, <i>see</i> COUMARIN DERIVATIVE PESTICIDE   | –  | –     | –      |
| Difenzoquat, <i>see</i> PESTICIDE, N.O.S.  | –  | –     | –      |
| 2,4-Difluoroaniline, <i>see</i>  | –  | 6.1   | 2941   |
| Difluorochloroethane, <i>see</i>   | –  | 2.1   | 2517   |
| Difluorodibromomethane, <i>see</i>   | –  | 9     | 1941   |
| 1,1-DIFLUOROETHANE   | –  | 2.1   | 1030   |
| Difluoroethane and dichlorodifluoromethane, azeotropic mixture with approximately 74% dichlorodifluoromethane, <i>see</i> DICHLORODIFLUOROMETHANE AND DIFLUOROETHANE, AZEOTROPIC MIXTURE | –  | –     | –      |
| 1,1-DIFLUOROETHYLENE   | –  | 2.1   | 1959   |
| DIFLUOROMETHANE  | –  | 2.1   | 3252   |
| DIFLUOROPHOSPHORIC ACID, ANHYDROUS   | –  | 8     | 1768   |
| 2,2-Dihydroperoxypropane (concentration $\leq 27\%$ , with inert solid), <i>see</i>  | –  | 5.2   | 3102   |

| Substance, material or article  | MP | Class | UN No. |
|---|----|-------|--------|
| 2,3-DIHYDROPYRAN  | –  | 3     | 2376   |
| <i>meta</i> -Dihydroxybenzene, <i>see</i>   | –  | 6.1   | 2876   |
| Di-(1-hydroxycyclohexyl) peroxide (concentration ≤ 100%), <i>see</i>                                    | –  | 5.2   | 3106   |
| DIISOBUTYLAMINE   | –  | 3     | 2361   |
| DIISOBUTYLENES, ISOMERIC COMPOUNDS  | –  | 3     | 2050   |
| DIISOBUTYL KETONE   | –  | 3     | 1157   |
| Diisobutyryl peroxide (concentration ≤ 42%, as a stable dispersion in water), <i>see</i>                | –  | 5.2   | 3119   |
| Diisobutyryl peroxide (concentration ≤ 32%, with diluent Type B), <i>see</i>                            | –  | 5.2   | 3115   |
| Diisobutyryl peroxide (concentration > 32–52%, with diluent Type A), <i>see</i>                         | –  | 5.2   | 3111   |
| DIISOCTYL ACID PHOSPHATE  | –  | 8     | 1902   |
| Diisopropyl, <i>see</i>   | –  | 3     | 2457   |
| DIISOPROPYLAMINE  | –  | 3     | 1158   |
| Diisopropylbenzene dihydroperoxide (concentration ≤ 82%, with diluent Type A and water), <i>see</i>     | –  | 5.2   | 3106   |
| Diisopropylbenzenes, <i>see</i>   | P  | 9     | 3082   |
| DIISOPROPYL ETHER   | –  | 3     | 1159   |
| Diisopropyl naphthalenes, mixed isomers, <i>see</i>   | P  | 9     | 3082   |
| Diisopropyl peroxydicarbonate (concentration ≤ 32%, with diluent Type A), <i>see</i>                    | –  | 5.2   | 3115   |
| Diisopropyl peroxydicarbonate (concentration ≤ 52%, with diluent Type B), <i>see</i>                    | –  | 5.2   | 3115   |
| Diisopropyl peroxydicarbonate (concentration > 52–100%), <i>see</i>                                     | –  | 5.2   | 3112   |
| DIKETENE, STABILIZED  | –  | 6.1   | 2521   |
| Dilauroyl peroxide (concentration ≤ 42%, as a stable dispersion in water), <i>see</i>                   | –  | 5.2   | 3109   |
| Dilauroyl peroxide (concentration ≤ 100%), <i>see</i>   | –  | 5.2   | 3106   |
| Dimefox, <i>see</i> ORGANOPHOSPHORUS PESTICIDE  | –  | –     | –      |
| Dimetan, <i>see</i> CARBAMATE PESTICIDE   | –  | –     | –      |
| Dimethoate, <i>see</i> ORGANOPHOSPHORUS PESTICIDE   | P  | –     | –      |
| Di-(3-methoxybutyl) peroxydicarbonate (concentration ≤ 52%, with diluent Type B), <i>see</i>            | –  | 5.2   | 3115   |
| 1,1-DIMETHOXYETHANE   | –  | 3     | 2377   |
| 1,2-DIMETHOXYETHANE   | –  | 3     | 2252   |
| Dimethoxymethane, <i>see</i>  | –  | 3     | 1234   |
| 2,5-Dimethoxy-4-(4-methylphenylsulphonyl)benzenediazonium zinc chloride (concentration 79%), <i>see</i> | –  | 4.1   | 3236   |
| Dimethoxystrychnine, <i>see</i>   | –  | 6.1   | 1570   |
| Dimethyl acetal, <i>see</i>   | –  | 3     | 2377   |
| 1,1-Dimethylacetone, <i>see</i>   | –  | 3     | 2397   |
| Dimethylacetylene, <i>see</i>   | –  | 3     | 1144   |
| DIMETHYLAMINE, ANHYDROUS  | –  | 2.1   | 1032   |
| DIMETHYLAMINE, AQUEOUS SOLUTION   | –  | 3     | 1160   |
| 2-DIMETHYLAMINOACETONITRILE   | –  | 3     | 2378   |

## Index

| Substance, material or article   | MP | Class | UN No. |
|--|----|-------|--------|
| 4-(Dimethylamino)benzenediazonium trichlorozincate(-1)<br>(concentration 100%), see  | –  | 4.1   | 3228   |
| 4-Dimethylamino-6-(2-dimethylaminoethoxy)toluene-2-diazonium zinc<br>chloride (concentration 100%), see  | –  | 4.1   | 3236   |
| 2-DIMETHYLAMINOETHANOL   | –  | 8     | 2051   |
| 2-DIMETHYLAMINOETHYL ACRYLATE, STABILIZED  | –  | 6.1   | 3302   |
| 2-DIMETHYLAMINOETHYL METHACRYLATE, STABILIZED  | –  | 6.1   | 2522   |
| <i>N,N</i> -DIMETHYLANILINE  | –  | 6.1   | 2253   |
| 3,4-Dimethylaniline, see   | –  | 6.1   | 1711   |
| Dimethylarsinic acid, see  | –  | 6.1   | 1572   |
| Dimethylbenzenes, see  | –  | 3     | 1307   |
| Di-(2-methylbenzoyl) peroxide (concentration ≤ 87%, with water), see   | –  | 5.2   | 3112   |
| Di-(3-methylbenzoyl) peroxide (concentration ≤ 20%), with benzoyl<br>(3-methylbenzoyl) peroxide (concentration ≤ 18%), with dibenzoyl<br>peroxide (concentration ≤ 4%) and diluent Type B, see | –  | 5.2   | 3115   |
| Di-(4-methylbenzoyl) peroxide (concentration ≤ 52%, as a paste with<br>silicon oil), see   | –  | 5.2   | 3106   |
| Dimethylbenzylamine, see   | –  | 8     | 2619   |
| <i>N,N</i> -Dimethylbenzylamine, see   | –  | 8     | 2619   |
| 2,3-DIMETHYLBUTANE   | –  | 3     | 2457   |
| 1,3-DIMETHYLBUTYLAMINE   | –  | 3     | 2379   |
| DIMETHYLCARBAMOYL CHLORIDE   | –  | 8     | 2262   |
| Dimethyl carbinol, see   | –  | 3     | 1219   |
| DIMETHYL CARBONATE   | –  | 3     | 1161   |
| DIMETHYLCYCLOHEXANES   | –  | 3     | 2263   |
| <i>N,N</i> -DIMETHYLCYCLOHEXYLAMINE  | –  | 8     | 2264   |
| 2,5-Dimethyl-2,5-di-(benzoylperoxy)hexane (concentration ≤ 82%,<br>with inert solid), see  | –  | 5.2   | 3106   |
| 2,5-Dimethyl-2,5-di-(benzoylperoxy)hexane (concentration ≤ 82%,<br>with water), see  | –  | 5.2   | 3104   |
| 2,5-Dimethyl-2,5-di-(benzoylperoxy)hexane (concentration<br>> 82–100%), see  | –  | 5.2   | 3102   |
| ■ 2,5-Dimethyl-2,5-di-( <i>tert</i> -butylperoxy) hexane (concentration<br>≤ 22%, with inert solid) ( <b>exempt</b> )  | –  | –     | –      |
| 2,5-Dimethyl-2,5-di-( <i>tert</i> -butylperoxy)hexane (concentration ≤ 47%, as<br>a paste), see  | –  | 5.2   | 3108   |
| 2,5-Dimethyl-2,5-di-( <i>tert</i> -butylperoxy)hexane (concentration ≤ 52%,<br>with diluent Type A), see   | –  | 5.2   | 3109   |
| 2,5-Dimethyl-2,5-di-( <i>tert</i> -butylperoxy)hexane (concentration<br>> 52–90%), see   | –  | 5.2   | 3105   |
| 2,5-Dimethyl-2,5-di-( <i>tert</i> -butylperoxy)hexane (concentration ≤ 77%,<br>with inert solid), see  | –  | 5.2   | 3108   |
| 2,5-Dimethyl-2,5-di-( <i>tert</i> -butylperoxy)hexane (concentration<br>> 90–100%), see  | –  | 5.2   | 3103   |
| 2,5-Dimethyl-2,5-di-( <i>tert</i> -butylperoxy)hexyne-3 (concentration ≤ 52%,<br>with inert solid), see  | –  | 5.2   | 3106   |
| 2,5-Dimethyl-2,5-di-( <i>tert</i> -butylperoxy)hexyne-3<br>(concentration > 52–86%, with diluent Type A), see  | –  | 5.2   | 3103   |

| Substance, material or article  | MP | Class | UN No. |
|---|----|-------|--------|
| 2,5-Dimethyl-2,5-di-( <i>tert</i> -butylperoxy)hexyne-3<br>(concentration > 86–100%), <i>see</i>                    | –  | 5.2   | 3101   |
| DIMETHYLDICHLOROSILANE  | –  | 3     | 1162   |
| DIMETHYLDIETHOXYSILANE  | –  | 3     | 2380   |
| 2,5-Dimethyl-2,5-di-(2-ethylhexanoylperoxy)hexane<br>(concentration ≤ 100%), <i>see</i>                             | –  | 5.2   | 3113   |
| 2,5-Dimethyl-2,5-dihydroperoxyhexane (concentration ≤ 82%, with<br>water), <i>see</i>                               | –  | 5.2   | 3104   |
| DIMETHYLDIOXANES  | –  | 3     | 2707   |
| DIMETHYL DISULPHIDE   | P  | 3     | 2381   |
| 2,5-Dimethyl-2,5-di-(3,5,5-trimethylhexanoylperoxy)hexane<br>(concentration ≤ 77%, with diluent Type A), <i>see</i> | –  | 5.2   | 3105   |
| <i>N,N</i> -Dimethyldodecylamine, <i>see</i> <b>Note 1</b>  | P  | –     | –      |
| Dimethyleneimine, stabilized, <i>see</i>  | –  | 6.1   | 1185   |
| Dimethylethanolamine, <i>see</i>  | –  | 8     | 2051   |
| DIMETHYL ETHER  | –  | 2.1   | 1033   |
| <i>N,N</i> -DIMETHYLFORMAMIDE   | –  | 3     | 2265   |
| <i>N,N</i> -Dimethylglycinonitrile, <i>see</i>  | –  | 3     | 2378   |
| Dimethylglyoxal, <i>see</i>   | –  | 3     | 2346   |
| 2,6-Dimethyl-4-heptanone, <i>see</i>  | –  | 3     | 1157   |
| 1,1-Dimethylhydrazine, <i>see</i>   | P  | 6.1   | 1163   |
| 1,2-Dimethylhydrazine, <i>see</i>   | P  | 6.1   | 2382   |
| DIMETHYLHYDRAZINE, SYMMETRICAL  | P  | 6.1   | 2382   |
| DIMETHYLHYDRAZINE, UNSYMMETRICAL  | P  | 6.1   | 1163   |
| 1,1-Dimethyl-3-hydroxybutyl peroxyneohexanoate<br>(concentration ≤ 52%, with diluent Type A), <i>see</i>            | –  | 5.2   | 3117   |
| Dimethyl ketone, <i>see</i>   | –  | 3     | 1090   |
| Dimethyl ketone solutions, <i>see</i>   | –  | 3     | 1090   |
| <i>N,N</i> -Dimethyl-4-nitrosoaniline, <i>see</i>   | –  | 4.2   | 1369   |
| <i>para</i> -Dimethylnitrosoaniline, <i>see</i>   | –  | 4.2   | 1369   |
| Dimethylphenols, liquid, <i>see</i>   | –  | 6.1   | 3430   |
| Dimethylphenols, solid, <i>see</i>  | –  | 6.1   | 2261   |
| Dimethyl phosphorochlorodithionate, <i>see</i>  | –  | 6.1   | 2267   |
| 2,2-DIMETHYLPROPANE   | –  | 2.1   | 2044   |
| DIMETHYL- <i>N</i> -PROPYLAMINE   | –  | 3     | 2266   |
| Dimethyl- <i>n</i> -propylamine, <i>see</i>   | –  | 3     | 2266   |
| Dimethyl <i>normal</i> -propyl carbinol, <i>see</i>   | –  | 3     | 2560   |
| DIMETHYL SULPHATE   | –  | 6.1   | 1595   |
| DIMETHYL SULPHIDE   | –  | 3     | 1164   |
| DIMETHYL THIOPHOSPHORYL CHLORIDE  | –  | 6.1   | 2267   |
| Dimethylzinc, <i>see</i>  | –  | 4.2   | 3394   |
| Dimetilan, <i>see</i> CARBAMATE PESTICIDE   | –  | –     | –      |
| Dimexano, <i>see</i> PESTICIDE, N.O.S.  | –  | –     | –      |
| Dimyristyl peroxydicarbonate (concentration ≤ 42%, as a stable<br>dispersion in water), <i>see</i>                  | –  | 5.2   | 3119   |



## Index

| Substance, material or article  | MP | Class | UN No. |
|---|----|-------|--------|
| Dimyristyl peroxydicarbonate (concentration $\leq 100\%$ ), see                                   | –  | 5.2   | 3116   |
| Di-(2-neodecanoylperoxyisopropyl)benzene (concentration $\leq 52\%$ , with diluent Type A), see   | –  | 5.2   | 3115   |
| DINGU   | –  | 1.1D  | 0489   |
| DINITROANILINES   | –  | 6.1   | 1596   |
| DINITROBENZENES, LIQUID   | –  | 6.1   | 1597   |
| DINITROBENZENES, SOLID  | –  | 6.1   | 3443   |
| Dinitrochlorobenzenes, liquid, see  | P  | 6.1   | 1577   |
| Dinitrochlorobenzenes, solid, see   | P  | 6.1   | 3441   |
| DINITRO- <i>o</i> -CRESOL   | P  | 6.1   | 1598   |
| Dinitrogen oxide, see   | –  | 2.2   | 1070   |
| Dinitrogen oxide, refrigerated liquid, see  | –  | 2.2   | 2201   |
| DINITROGEN TETROXIDE  | –  | 2.3   | 1067   |
| Dinitrogen tetroxide and nitric oxide mixtures, see NITRIC OXIDE AND DINITROGEN TETROXIDE MIXTURE | –  | –     | –      |
| Dinitrogen trioxide, see  | –  | 2.3   | 2421   |
| DINITROGLYCOURIL  | –  | 1.1D  | 0489   |
| Dinitrophenates (class 1), see  | P  | 1.3C  | 0077   |
| Dinitrophenates, wetted, see  | P  | 4.1   | 1321   |
| DINITROPHENOLATES, alkali metals, dry or wetted with less than 15% water, by mass                 | P  | 1.3C  | 0077   |
| DINITROPHENOLATES, WETTED with not less than 15% water, by mass                                   | P  | 4.1   | 1321   |
| DINITROPHENOL, dry or wetted with less than 15% water, by mass                                    | P  | 1.1D  | 0076   |
| DINITROPHENOL SOLUTION  | P  | 6.1   | 1599   |
| DINITROPHENOL, WETTED with not less than 15% water, by mass                                       | P  | 4.1   | 1320   |
| DINITRORESORCINOL, dry or wetted with less than 15% water, by mass                                | –  | 1.1D  | 0078   |
| DINITRORESORCINOL, WETTED with not less than 15% water, by mass                                   | –  | 4.1   | 1322   |
| DINITROSOBENZENE  | –  | 1.3C  | 0406   |
| <i>N,N'</i> -Dinitroso- <i>N,N'</i> -dimethylterephthalamide, as a paste (concentration 72%), see | –  | 4.1   | 3224   |
| <i>N,N'</i> -Dinitrosopentamethylenetetramine (concentration 82%), see                            | –  | 4.1   | 3224   |
| Dinitrotoluene mixed with sodium chlorate, see  | –  | 1.1D  | 0083   |
| DINITROTOLUENES, LIQUID   | P  | 6.1   | 2038   |
| DINITROTOLUENES, MOLTEN   | P  | 6.1   | 1600   |
| DINITROTOLUENES, SOLID  | P  | 6.1   | 3454   |
| Dinobuton, see SUBSTITUTED NITROPHENOL PESTICIDE  | P  | –     | –      |
| Di- <i>n</i> -nonanoyl peroxide (concentration $\leq 100\%$ ), see                                | –  | 5.2   | 3116   |
| Dinoseb, see SUBSTITUTED NITROPHENOL PESTICIDE  | P  | –     | –      |
| Dinoseb acetate, see SUBSTITUTED NITROPHENOL PESTICIDE  | P  | –     | –      |
| Dinoterb, see SUBSTITUTED NITROPHENOL PESTICIDE   | –  | –     | –      |
| Dinoterb acetate, see SUBSTITUTED NITROPHENOL PESTICIDE   | –  | –     | –      |
| Di- <i>n</i> -octanoyl peroxide (concentration $\leq 100\%$ ), see                                | –  | 5.2   | 3114   |

| Substance, material or article  | MP | Class | UN No. |
|---|----|-------|--------|
| Dioxacarb, <i>see</i> CARBAMATE PESTICIDE   | P  | –     | –      |
| DIOXANE   | –  | 3     | 1165   |
| Dioxathion, <i>see</i> ORGANOPHOSPHORUS PESTICIDE   | P  | –     | –      |
| DIOXOLANE   | –  | 3     | 1166   |
| DIPENTENE   | P  | 3     | 2052   |
| Di- <i>normal</i> -pentylamine, <i>see</i>  | –  | 3     | 2841   |
| Diphacinone, <i>see</i> PESTICIDE, N.O.S.   | P  | –     | –      |
| Di-(2-phenoxyethyl) peroxydicarbonate (concentration ≤ 85%, with water), <i>see</i>           | –  | 5.2   | 3106   |
| Di-(2-phenoxyethyl) peroxydicarbonate (concentration > 85–100%), <i>see</i>                   | –  | 5.2   | 3102   |
| Diphenyl, <i>see</i>  | P  | 9     | 3077   |
| DIPHENYLAMINE CHLOROARSINE  | P  | 6.1   | 1698   |
| Diphenylbromomethane, <i>see</i>  | –  | 8     | 1770   |
| DIPHENYLCHLOROARSINE, LIQUID  | P  | 6.1   | 1699   |
| DIPHENYLCHLOROARSINE, SOLID   | P  | 6.1   | 3450   |
| DIPHENYLDICHLOROSILANE  | –  | 8     | 1769   |
| DIPHENYLMETHYL BROMIDE  | –  | 8     | 1770   |
| Diphenyloxide-4,4'-disulphonylhydrazide (concentration 100%), <i>see</i>                      | –  | 4.1   | 3226   |
| DIPICRYLAMINE   | –  | 1.1D  | 0079   |
| DIPICRYL SULPHIDE, dry or wetted with less than 10% water, by mass                            | –  | 1.1D  | 0401   |
| DIPICRYL SULPHIDE, WETTED with not less than 10% water, by mass                               | –  | 4.1   | 2852   |
| Di-2-propenylamine, <i>see</i>  | –  | 3     | 2359   |
| Dipropionyl peroxide (concentration ≤ 27%, with diluent Type B), <i>see</i>                   | –  | 5.2   | 3117   |
| DIPROPYLAMINE   | –  | 3     | 2383   |
| Di- <i>n</i> -propylamine, <i>see</i>   | –  | 3     | 2383   |
| 4-Dipropylaminobenzenediazonium zinc chloride (concentration 100%), <i>see</i>                | –  | 4.1   | 3226   |
| Dipropylenetriamine, <i>see</i>   | –  | 8     | 2269   |
| DI- <i>n</i> -PROPYL ETHER  | –  | 3     | 2384   |
| DIPROPYL KETONE   | –  | 3     | 2710   |
| Di- <i>n</i> -propyl peroxydicarbonate (concentration ≤ 77%, with diluent Type B), <i>see</i> | –  | 5.2   | 3113   |
| Di- <i>n</i> -propyl peroxydicarbonate (concentration ≤ 100%), <i>see</i>                     | –  | 5.2   | 3113   |
| Diquat, <i>see</i> BIPYRIDILIUM PESTICIDE   | –  | –     | –      |
| ■ DISILANE  | –  | 2.1   | 3553   |
| DISINFECTANT, LIQUID, CORROSIVE, N.O.S.   | –  | 8     | 1903   |
| DISINFECTANT, LIQUID, TOXIC, N.O.S.   | –  | 6.1   | 3142   |
| DISINFECTANT, SOLID, TOXIC, N.O.S.  | –  | 6.1   | 1601   |
| DISODIUM TRIOXOSILICATE   | –  | 8     | 3253   |
| Disodium trioxosilicate pentahydrate, <i>see</i>  | –  | 8     | 3253   |
| Disuccinic acid peroxide (concentration ≤ 72%, with water), <i>see</i>                        | –  | 5.2   | 3116   |
| Disuccinic acid peroxide (concentration > 72–100%), <i>see</i>                                | –  | 5.2   | 3102   |
| Disulfoton, <i>see</i> ORGANOPHOSPHORUS PESTICIDE   | P  | –     | –      |

## Index

| Substance, material or article   | MP | Class | UN No. |
|--|----|-------|--------|
| Disulphuric acid, <i>see</i>   | –  | 8     | 1831   |
| Disulphuryl chloride, <i>see</i>   | –  | 8     | 1817   |
| Di-(3,5,5-trimethylhexanoyl) peroxide (concentration ≤ 38%, with diluent Type A), <i>see</i>                                 | –  | 5.2   | 3119   |
| Di-(3,5,5-trimethylhexanoyl) peroxide (concentration > 52–82%, with diluent Type A), <i>see</i>                              | –  | 5.2   | 3115   |
| Di-(3,5,5-trimethylhexanoyl) peroxide (concentration ≤ 52%, as a stable dispersion in water), <i>see</i>                     | –  | 5.2   | 3119   |
| Di-(3,5,5-trimethylhexanoyl) peroxide (concentration > 38–52%, with diluent Type A), <i>see</i>                              | –  | 5.2   | 3119   |
| DIVINYL ETHER, STABILIZED  | –  | 3     | 1167   |
| Divinyl oxide, stabilized, <i>see</i>  | –  | 3     | 1167   |
| Divinyl, stabilized, <i>see</i>  | –  | 2.1   | 1010   |
| DNOC, <i>see</i>   | P  | 6.1   | 1598   |
| DNOC (pesticide), <i>see</i> SUBSTITUTED NITROPHENOL PESTICIDE   | P  | –     | –      |
| Dodecahydrodiphenylamine, <i>see</i>   | –  | 8     | 2565   |
| 1-dodecene, <i>see</i>   | –  | 3     | 2850   |
| Dodecene, <i>see</i>   | P  | 3     | 2850   |
| 1-Dodecylamine, <i>see</i> Note 1  | P  | –     | –      |
| Dodecyl diphenyl oxide disulphonate, <i>see</i>  | P  | 9     | 3077   |
| Dodecyl hydroxypropyl sulphide, <i>see</i> Note 1  | P  | –     | –      |
| Dodecylphenol, <i>see</i>  | P  | 8     | 3145   |
| DODECYLTRICHLOROSILANE   | –  | 8     | 1771   |
| Drazoxolon, <i>see</i> ORGANOCHLORINE PESTICIDE  | P  | –     | –      |
| DRY ICE  | –  | 9     | 1845   |
| DYE INTERMEDIATE, LIQUID, CORROSIVE, N.O.S.  | –  | 8     | 2801   |
| DYE INTERMEDIATE, LIQUID, TOXIC, N.O.S.  | –  | 6.1   | 1602   |
| DYE INTERMEDIATE, SOLID, CORROSIVE, N.O.S.   | –  | 8     | 3147   |
| DYE INTERMEDIATE, SOLID, TOXIC, N.O.S.   | –  | 6.1   | 3143   |
| DYE, LIQUID, CORROSIVE, N.O.S.   | –  | 8     | 2801   |
| DYE, LIQUID, TOXIC, N.O.S.   | –  | 6.1   | 1602   |
| DYE, SOLID, CORROSIVE, N.O.S.  | –  | 8     | 3147   |
| DYE, SOLID, TOXIC, N.O.S.  | –  | 6.1   | 3143   |
| Dynamite, <i>see</i>   | –  | 1.1D  | 0081   |
| Edifenphos, <i>see</i> ORGANOPHOSPHORUS PESTICIDE  | P  | –     | –      |
| Electric storage batteries, <i>see</i> BATTERIES   | –  | –     | –      |
| Electrolyte (acid) for batteries, <i>see</i>   | –  | 8     | 2796   |
| Electrolyte (alkaline) for batteries, <i>see</i>   | –  | 8     | 2797   |
| ELEVATED TEMPERATURE LIQUID, FLAMMABLE, N.O.S. with flashpoint above 60°C, at or above its flashpoint                        | –  | 3     | 3256   |
| ELEVATED TEMPERATURE LIQUID, N.O.S. at or above 100°C and below its flashpoint (including molten metals, molten salts, etc.) | –  | 9     | 3257   |
| ELEVATED TEMPERATURE SOLID, N.O.S. at or above 240°C   | –  | 9     | 3258   |
| Enamel, <i>see</i> PAINT   | –  | –     | –      |

| Substance, material or article   | MP | Class | UN No. |
|--|----|-------|--------|
| Endosulfan, <i>see</i> ORGANOCHLORINE PESTICIDE  | P  | –     | –      |
| Endothal-sodium, <i>see</i> PESTICIDE, N.O.S.  | –  | –     | –      |
| Endothion, <i>see</i> ORGANOPHOSPHORUS PESTICIDE   | –  | –     | –      |
| Endrin, <i>see</i> ORGANOCHLORINE PESTICIDE  | P  | –     | –      |
| ENGINE, FUEL CELL, FLAMMABLE GAS POWERED   | –  | 2.1   | 3529   |
| ENGINE, FUEL CELL, FLAMMABLE LIQUID POWERED  | –  | 3     | 3528   |
| ENGINE, INTERNAL COMBUSTION  | P  | 9     | 3530   |
| ENGINE, INTERNAL COMBUSTION, FLAMMABLE GAS POWERED   | –  | 2.1   | 3529   |
| ENGINE, INTERNAL COMBUSTION, FLAMMABLE LIQUID POWERED                                      | –  | 3     | 3528   |
| Engines, rocket, <i>see</i> ROCKET MOTORS WITH HYPERGOLIC LIQUIDS                          | –  | –     | –      |
| ENVIRONMENTALLY HAZARDOUS SUBSTANCE, LIQUID, N.O.S.  | –  | 9     | 3082   |
| ENVIRONMENTALLY HAZARDOUS SUBSTANCE, SOLID, N.O.S.   | –  | 9     | 3077   |
| EPIBROMOHYDRIN   | P  | 6.1   | 2558   |
| EPICHLOROHYDRIN  | P  | 6.1   | 2023   |
| EPN, <i>see</i> ORGANOPHOSPHORUS PESTICIDE   | P  | –     | –      |
| 1,2-Epoxybutane, stabilized, <i>see</i>  | –  | 3     | 3022   |
| 1,2-Epoxyethane, <i>see</i>  | –  | 2.3   | 1040   |
| 1,2-Epoxyethane with nitrogen up to a total pressure of 1 MPa (10 bar) at 50°C, <i>see</i> | –  | 2.3   | 1040   |
| 1,2-EPOXY-3-ETHOXYPROPANE  | –  | 3     | 2752   |
| 2,3-Epoxy-1-propanal, <i>see</i>   | –  | 3     | 2622   |
| 1,2-Epoxypropane, <i>see</i>   | –  | 3     | 1280   |
| 2,3-Epoxypropionaldehyde, <i>see</i>   | –  | 3     | 2622   |
| 2,3-Epoxypropyl ethyl ether, <i>see</i>  | –  | 3     | 2752   |
| Esfenvalerate, <i>see</i> Note 1   | P  | –     | –      |
| ESTERS, N.O.S.   | –  | 3     | 3272   |
| Ethanal, <i>see</i>  | –  | 3     | 1089   |
| ETHANE   | –  | 2.1   | 1035   |
| ETHANE, REFRIGERATED LIQUID  | –  | 2.1   | 1961   |
| Ethanethiol, <i>see</i>  | P  | 3     | 2363   |
| Ethanoic anhydride, <i>see</i>   | –  | 8     | 1715   |
| ETHANOL  | –  | 3     | 1170   |
| ETHANOLAMINE   | –  | 8     | 2491   |
| ETHANOLAMINE SOLUTION  | –  | 8     | 2491   |
| ETHANOL AND GASOLINE MIXTURE, with more than 10% ethanol                                   | –  | 3     | 3475   |
| ETHANOL AND MOTOR SPIRIT MIXTURE, with more than 10% ethanol                               | –  | 3     | 3475   |
| ETHANOL AND PETROL MIXTURE, with more than 10% ethanol                                     | –  | 3     | 3475   |
| ETHANOL SOLUTION   | –  | 3     | 1170   |
| Ethanoyl chloride, <i>see</i>  | –  | 3     | 1717   |
| Ether, <i>see</i>  | –  | 3     | 1155   |
| ETHERS, N.O.S.   | –  | 3     | 3271   |
| Ethion, <i>see</i> ORGANOPHOSPHORUS PESTICIDE  | P  | –     | –      |
| Ethoate-methyl, <i>see</i> ORGANOPHOSPHORUS PESTICIDE                                      | –  | –     | –      |

## Index

| Substance, material or article  | MP | Class | UN No. |
|---|----|-------|--------|
| Ethoprophos, see ORGANOPHOSPHORUS PESTICIDE   | P  | –     | –      |
| 2-( <i>N,N</i> -Ethoxycarbonylphenylamino)-3-methoxy-4-( <i>N</i> -methyl- <i>N</i> -cyclohexylamino)benzenediazonium zinc chloride (concentration 62%), see    | –  | 4.1   | 3236   |
| 2-( <i>N,N</i> -Ethoxycarbonylphenylamino)-3-methoxy-4-( <i>N</i> -methyl- <i>N</i> -cyclohexylamino)benzenediazonium zinc chloride (concentration 63–92%), see | –  | 4.1   | 3236   |
| 2-Ethoxyethanol, see  | –  | 3     | 1171   |
| 2-Ethoxyethyl acetate, see  | –  | 3     | 1172   |
| 1-Ethoxypropane, see  | –  | 3     | 2615   |
| 3-Ethoxy-1-propene, see   | –  | 3     | 2335   |
| ETHYL ACETATE   | –  | 3     | 1173   |
| Ethylacetic acid, see   | –  | 8     | 2820   |
| Ethylacetone, see   | –  | 3     | 1249   |
| ETHYLACETYLENE, STABILIZED  | –  | 2.1   | 2452   |
| ETHYL ACRYLATE, STABILIZED  | –  | 3     | 1917   |
| Ethylal, see  | –  | 3     | 2373   |
| ETHYL ALCOHOL   | –  | 3     | 1170   |
| ETHYL ALCOHOL SOLUTION  | –  | 3     | 1170   |
| Ethyl aldehyde, see   | –  | 3     | 1089   |
| Ethyl allyl ether, see  | –  | 3     | 2335   |
| ETHYLAMINE  | –  | 2.1   | 1036   |
| ETHYLAMINE, AQUEOUS SOLUTION with not less than 50% but not more than 70% ethylamine  | –  | 3     | 2270   |
| ETHYL AMYL KETONES  | –  | 3     | 2271   |
| Ethyl <i>normal</i> -amyl ketone, see   | –  | 3     | 2271   |
| 2-ETHYLANILINE  | –  | 6.1   | 2273   |
| <i>N</i> -ETHYLANILINE  | –  | 6.1   | 2272   |
| <i>ortho</i> -Ethylaniline, see   | –  | 6.1   | 2273   |
| ETHYLBENZENE  | –  | 3     | 1175   |
| Ethylbenzol, see  | –  | 3     | 1175   |
| <i>N</i> -ETHYL- <i>N</i> -BENZYLANILINE  | –  | 6.1   | 2274   |
| <i>N</i> -ETHYLBENZYL TOLUIDINES, LIQUID  | –  | 6.1   | 2753   |
| <i>N</i> -ETHYLBENZYL TOLUIDINES, SOLID   | –  | 6.1   | 3460   |
| ETHYL BORATE  | –  | 3     | 1176   |
| ETHYL BROMIDE   | –  | 3     | 1891   |
| ETHYL BROMOACETATE  | –  | 6.1   | 1603   |
| Ethyl butanoate, see  | –  | 3     | 1180   |
| 2-ETHYLBUTANOL  | –  | 3     | 2275   |
| 2-ETHYLBUTYL ACETATE  | –  | 3     | 1177   |
| 2-Ethylbutyl alcohol, see   | –  | 3     | 2275   |
| ETHYL BUTYL ETHER   | –  | 3     | 1179   |
| 2-ETHYLBUTYRALDEHYDE  | –  | 3     | 1178   |
| ETHYL BUTYRATE  | –  | 3     | 1180   |
| Ethyl carbonate, see  | –  | 3     | 2366   |

| Substance, material or article   | MP | Class | UN No. |
|--|----|-------|--------|
| ETHYL CHLORIDE   | –  | 2.1   | 1037   |
| ETHYL CHLOROACETATE  | –  | 6.1   | 1181   |
| Ethyl chlorocarbonate, <i>see</i>  | –  | 6.1   | 1182   |
| Ethyl chloroethanoate, <i>see</i>  | –  | 6.1   | 1181   |
| ETHYL CHLOROFORMATE  | –  | 6.1   | 1182   |
| ETHYL 2-CHLOROPROPIONATE   | –  | 3     | 2935   |
| ETHYL CHLOROTHIOFORMATE  | P  | 8     | 2826   |
| ETHYL CROTONATE  | –  | 3     | 1862   |
| Ethyl cyanide, <i>see</i>  | –  | 3     | 2404   |
| Ethyl 3,3-di-( <i>tert</i> -amylperoxy)butyrate (concentration ≤ 67%, with diluent Type A), <i>see</i>   | –  | 5.2   | 3105   |
| Ethyl 3,3-di-( <i>tert</i> -butylperoxy)butyrate (concentration ≤ 52%, with inert solid), <i>see</i>   | –  | 5.2   | 3106   |
| Ethyl 3,3-di-( <i>tert</i> -butylperoxy)butyrate (concentration ≤ 77%, with diluent Type A), <i>see</i>  | –  | 5.2   | 3105   |
| Ethyl 3,3-di-( <i>tert</i> -butylperoxy)butyrate (concentration > 77–100%), <i>see</i>   | –  | 5.2   | 3103   |
| ETHYLDICHLOROARSINE  | P  | 6.1   | 1892   |
| ETHYLDICHLOROSILANE  | –  | 4.3   | 1183   |
| ETHYLENE   | –  | 2.1   | 1962   |
| ETHYLENE, ACETYLENE AND PROPYLENE MIXTURE, REFRIGERATED LIQUID containing at least 71.5% ethylene, with not more than 22.5% acetylene and not more than 6% propylene | –  | 2.1   | 3138   |
| Ethylene chloride, <i>see</i>  | –  | 3     | 1184   |
| ETHYLENE CHLOROHYDRIN  | –  | 6.1   | 1135   |
| ETHYLENEDIAMINE  | –  | 8     | 1604   |
| ETHYLENE DIBROMIDE   | –  | 6.1   | 1605   |
| Ethylene dibromide and methyl bromide mixture, liquid, <i>see</i>  | P  | 6.1   | 1647   |
| ETHYLENE DICHLORIDE  | –  | 3     | 1184   |
| Ethylene fluoride, <i>see</i>  | –  | 2.1   | 1030   |
| ETHYLENE GLYCOL DIETHYL ETHER  | –  | 3     | 1153   |
| Ethylene glycol dimethyl ether, <i>see</i>   | –  | 3     | 2252   |
| ETHYLENE GLYCOL MONOETHYL ETHER  | –  | 3     | 1171   |
| ETHYLENE GLYCOL MONOETHYL ETHER ACETATE  | –  | 3     | 1172   |
| ETHYLENE GLYCOL MONOMETHYL ETHER   | –  | 3     | 1188   |
| ETHYLENE GLYCOL MONOMETHYL ETHER ACETATE   | –  | 3     | 1189   |
| ETHYLENEIMINE, STABILIZED  | –  | 6.1   | 1185   |
| ETHYLENE OXIDE   | –  | 2.3   | 1040   |
| ETHYLENE OXIDE AND CARBON DIOXIDE MIXTURE with more than 87% ethylene oxide  | –  | 2.3   | 3300   |
| ETHYLENE OXIDE AND CARBON DIOXIDE MIXTURE with more than 9% but not more than 87% ethylene oxide   | –  | 2.1   | 1041   |
| ETHYLENE OXIDE AND CARBON DIOXIDE MIXTURE with not more than 9% ethylene oxide   | –  | 2.2   | 1952   |
| ETHYLENE OXIDE AND CHLOROTETRAFLUOROETHANE MIXTURE with not more than 8.8% ethylene oxide  | –  | 2.2   | 3297   |



## Index

| Substance, material or article  | MP | Class | UN No. |
|---|----|-------|--------|
| ETHYLENE OXIDE AND DICHLORODIFLUOROMETHANE MIXTURE with not more than 12.5% ethylene oxide                                | –  | 2.2   | 3070   |
| ETHYLENE OXIDE AND PENTAFLUOROETHANE MIXTURE with not more than 7.9% ethylene oxide                                       | –  | 2.2   | 3298   |
| ETHYLENE OXIDE AND PROPYLENE OXIDE MIXTURE with not more than 30% ethylene oxide  | –  | 3     | 2983   |
| ETHYLENE OXIDE AND TETRAFLUOROETHANE MIXTURE with not more than 5.6% ethylene oxide                                       | –  | 2.2   | 3299   |
| ETHYLENE OXIDE WITH NITROGEN up to a total pressure of 1 MPa (10 bar) at 50°C   | –  | 2.3   | 1040   |
| ETHYLENE, REFRIGERATED LIQUID   | –  | 2.1   | 1038   |
| Ethyl ethanoate, <i>see</i>   | –  | 3     | 1173   |
| ETHYL ETHER   | –  | 3     | 1155   |
| Ethyl fluid, <i>see</i>   | P  | 6.1   | 1649   |
| ETHYL FLUORIDE  | –  | 2.1   | 2453   |
| ETHYL FORMATE   | –  | 3     | 1190   |
| Ethyl glycol, <i>see</i>  | –  | 3     | 1171   |
| Ethyl glycol acetate, <i>see</i>  | –  | 3     | 1172   |
| 2-Ethylhexaldehyde, <i>see</i>  | –  | 3     | 1191   |
| 3-Ethylhexaldehyde, <i>see</i>  | –  | 3     | 1191   |
| 2-Ethylhexanal, <i>see</i>  | –  | 3     | 1191   |
| 3-Ethylhexanal, <i>see</i>  | –  | 3     | 1191   |
| 1-(2-Ethylhexanoylperoxy)-1,3-dimethylbutyl peroxy-pivalate (concentration ≤ 52%, with diluents Type A and B), <i>see</i> | –  | 5.2   | 3115   |
| 2-ETHYLHEXYLAMINE   | –  | 3     | 2276   |
| 2-ETHYLHEXYL CHLOROFORMATE  | –  | 6.1   | 2748   |
| 2-Ethylhexyl nitrate, <i>see Note 1</i>   | P  | –     | –      |
| Ethyl hydrosulphide, <i>see</i>   | P  | 3     | 2363   |
| Ethylidene chloride, <i>see</i>   | –  | 3     | 2362   |
| Ethylidene dichloride, <i>see</i>   | –  | 3     | 2362   |
| Ethylidene diethyl ether, <i>see</i>  | –  | 3     | 1088   |
| Ethylidene difluoride, <i>see</i>   | –  | 2.1   | 1030   |
| Ethylidene dimethyl ether, <i>see</i>   | –  | 3     | 2377   |
| Ethylidene fluoride, <i>see</i>   | –  | 2.1   | 1030   |
| ETHYL ISOBUTYRATE   | –  | 3     | 2385   |
| ETHYL ISOCYANATE  | –  | 6.1   | 2481   |
| Ethyl isopropyl ether, <i>see</i>   | –  | 3     | 2615   |
| ETHYL LACTATE   | –  | 3     | 1192   |
| ETHYL MERCAPTAN   | P  | 3     | 2363   |
| ETHYL METHACRYLATE, STABILIZED  | –  | 3     | 2277   |
| Ethyl methanoate, <i>see</i>  | –  | 3     | 1190   |
| 1-Ethyl-2-methylbenzene, <i>see Note 1</i>  | P  | –     | –      |
| ETHYL METHYL ETHER  | –  | 2.1   | 1039   |
| ETHYL METHYL KETONE   | –  | 3     | 1193   |
| Ethyl 2-methylpropanoate, <i>see</i>  | –  | 3     | 2385   |

| Substance, material or article   | MP | Class | UN No. |
|--|----|-------|--------|
| ETHYL NITRITE (transport prohibited)   | –  | –     | –      |
| ETHYL NITRITE SOLUTION   | –  | 3     | 1194   |
| ETHYL ORTHOFORMATE   | –  | 3     | 2524   |
| ETHYL OXALATE  | –  | 6.1   | 2525   |
| Ethylphenylamine, <i>see</i>   | –  | 6.1   | 2272   |
| <i>N</i> -Ethyl- <i>N</i> -phenylbenzylamine, <i>see</i>                           | –  | 6.1   | 2274   |
| ETHYLPHENYLDICHLOROSILANE  | –  | 8     | 2435   |
| 5-Ethyl-2-picoline, <i>see</i>   | –  | 6.1   | 2300   |
| 1-ETHYLPIPERIDINE  | –  | 3     | 2386   |
| <i>N</i> -Ethylpiperidine, <i>see</i>  | –  | 3     | 2386   |
| Ethyl propenoate, stabilized, <i>see</i>   | –  | 3     | 1917   |
| ETHYL PROPIONATE   | –  | 3     | 1195   |
| ETHYL PROPYL ETHERS  | –  | 3     | 2615   |
| Ethyl <i>secondary</i> -amyl ketone, <i>see</i>                                    | –  | 3     | 2271   |
| Ethyl silicate, <i>see</i>   | –  | 3     | 1292   |
| Ethyl sulphate, <i>see</i>   | –  | 6.1   | 1594   |
| Ethyl sulphide, <i>see</i>   | –  | 3     | 2375   |
| Ethyl tetraphosphate, <i>see</i>   | P  | 6.1   | 1611   |
| Ethyl thioalcohol, <i>see</i>  | P  | 3     | 2363   |
| Ethylthioethane, <i>see</i>  | –  | 3     | 2375   |
| <i>N</i> -ETHYLTOLUIDINES  | –  | 6.1   | 2754   |
| ETHYLTRICHLOROSILANE   | –  | 3     | 1196   |
| Ethyl vinyl ether, <i>see</i>  | –  | 3     | 1302   |
| Explosive articles, N.O.S., <i>see</i> ARTICLES, EXPLOSIVE, N.O.S.                 | –  | –     | –      |
| EXPLOSIVE, BLASTING, TYPE A  | –  | 1.1D  | 0081   |
| EXPLOSIVE, BLASTING, TYPE B  | –  | 1.1D  | 0082   |
| EXPLOSIVE, BLASTING, TYPE B  | –  | 1.5D  | 0331   |
| EXPLOSIVE, BLASTING, TYPE C  | –  | 1.1D  | 0083   |
| EXPLOSIVE, BLASTING, TYPE D  | –  | 1.1D  | 0084   |
| EXPLOSIVE, BLASTING, TYPE E  | –  | 1.1D  | 0241   |
| EXPLOSIVE, BLASTING, TYPE E  | –  | 1.5D  | 0332   |
| Explosive, seismic, <i>see</i> EXPLOSIVE, BLASTING, TYPES A to D                   | –  | –     | –      |
| Explosives, emulsion, <i>see</i> EXPLOSIVE, BLASTING, TYPE E                       | –  | –     | –      |
| Explosive, slurry, <i>see</i> EXPLOSIVE, BLASTING, TYPE E                          | –  | –     | –      |
| Explosive substances, N.O.S., <i>see</i> SUBSTANCES, EXPLOSIVE, N.O.S.             | –  | –     | –      |
| Explosive train components, N.O.S., <i>see</i> COMPONENTS, EXPLOSIVE TRAIN, N.O.S. | –  | –     | –      |
| Explosive, watergel, <i>see</i> EXPLOSIVE, BLASTING, TYPE E                        | –  | –     | –      |
| Extracts, aromatic, liquid, <i>see</i>   | –  | 3     | 1197   |
| Extracts, flavouring, liquid, <i>see</i>   | –  | 3     | 1197   |
| EXTRACTS, LIQUID, for flavour or aroma   | –  | 3     | 1197   |
| FABRICS, ANIMAL, N.O.S. with oil   | –  | 4.2   | 1373   |

## Index

| Substance, material or article  | MP | Class | UN No. |
|---|----|-------|--------|
| FABRICS IMPREGNATED WITH WEAKLY NITRATED NITROCELLULOSE, N.O.S.                 | –  | 4.1   | 1353   |
| FABRICS, SYNTHETIC, N.O.S. with oil   | –  | 4.2   | 1373   |
| FABRICS, VEGETABLE, N.O.S. with oil   | –  | 4.2   | 1373   |
| Fenaminosulf, see PESTICIDE, N.O.S.   | –  | –     | –      |
| Fenaminphos, see ORGANOPHOSPHORUS PESTICIDE                                     | P  | –     | –      |
| Fenbutatin oxide, see Note 1  | P  | –     | –      |
| Fenitrothion, see ORGANOPHOSPHORUS PESTICIDE                                    | P  | –     | –      |
| Fenoxapro-ethyl, see Note 1   | P  | –     | –      |
| Fenoxaprop-P-ethyl, see Note 1  | P  | –     | –      |
| Fenpropathrin, see PESTICIDE, N.O.S.  | P  | –     | –      |
| Fensulfothion, see ORGANOPHOSPHORUS PESTICIDE                                   | P  | –     | –      |
| Fenthion, see ORGANOPHOSPHORUS PESTICIDE  | P  | –     | –      |
| Fentin acetate, see ORGANOTIN PESTICIDE   | P  | –     | –      |
| Fentin hydroxide, see ORGANOTIN PESTICIDE                                       | P  | –     | –      |
| Fermentation amyl alcohol, see  | –  | 3     | 1201   |
| FERRIC ARSENATE   | P  | 6.1   | 1606   |
| FERRIC ARSENITE   | P  | 6.1   | 1607   |
| FERRIC CHLORIDE, ANHYDROUS  | –  | 8     | 1773   |
| FERRIC CHLORIDE SOLUTION  | –  | 8     | 2582   |
| FERRIC NITRATE  | –  | 5.1   | 1466   |
| Ferric perchloride, anhydrous, see  | –  | 8     | 1773   |
| Ferric perchloride solution, see  | –  | 8     | 2582   |
| FERROCERIUM   | –  | 4.1   | 1323   |
| FERROSILICON with 30% or more but less than 90% silicon                         | –  | 4.3   | 1408   |
| FERROUS ARSENATE  | P  | 6.1   | 1608   |
| FERROUS METAL BORINGS in a form liable to self-heating                          | –  | 4.2   | 2793   |
| FERROUS METAL CUTTINGS in a form liable to self-heating                         | –  | 4.2   | 2793   |
| FERROUS METAL SHAVINGS in a form liable to self-heating                         | –  | 4.2   | 2793   |
| FERROUS METAL TURNINGS in a form liable to self-heating                         | –  | 4.2   | 2793   |
| FERTILIZER AMMONIATING SOLUTION with free ammonia                               | –  | 2.2   | 1043   |
| Fertilizers containing ammonium nitrate, see AMMONIUM NITRATE BASED FERTILIZERS | –  | –     | –      |
| FIBRES, ANIMAL, burnt   | –  | 4.2   | 1372   |
| FIBRES, ANIMAL, damp  | –  | 4.2   | 1372   |
| FIBRES, ANIMAL, wet   | –  | 4.2   | 1372   |
| FIBRES, ANIMAL, N.O.S. with oil   | –  | 4.2   | 1373   |
| FIBRES, SYNTHETIC, N.O.S. with oil  | –  | 4.2   | 1373   |
| FIBRES, VEGETABLE, burnt  | –  | 4.2   | 1372   |
| FIBRES, VEGETABLE, damp   | –  | 4.2   | 1372   |
| FIBRES, VEGETABLE, dry  | –  | 4.1   | 3360   |
| FIBRES, VEGETABLE, wet  | –  | 4.2   | 1372   |
| FIBRES, VEGETABLE, N.O.S. with oil  | –  | 4.2   | 1373   |

| Substance, material or article   | MP | Class | UN No. |
|--|----|-------|--------|
| FIBRES IMPREGNATED WITH WEAKLY NITRATED NITROCELLULOSE, N.O.S.   | –  | 4.1   | 1353   |
| Filler, liquid, see PAINT  | –  | –     | –      |
| Films, nitrocellulose-base, from which gelatin has been removed; film scrap, see   | –  | 4.2   | 2002   |
| FILMS, NITROCELLULOSE BASE, gelatin coated, except scrap   | –  | 4.1   | 1324   |
| FIRE EXTINGUISHER CHARGES, corrosive liquid  | –  | 8     | 1774   |
| Fire extinguisher charges, expelling, explosive, see CARTRIDGES, POWER DEVICE  | –  | –     | –      |
| FIRE EXTINGUISHERS with compressed or liquefied gas  | –  | 2.2   | 1044   |
| FIRELIGHTERS, SOLID with flammable liquid  | –  | 4.1   | 2623   |
| ■ FIRE SUPPRESSANT DISPERSING DEVICES  | –  | 1.4S  | 0514   |
| ■ FIRE SUPPRESSANT DISPERSING DEVICES  | –  | 9     | 3559   |
| FIREWORKS  | –  | 1.1G  | 0333   |
| FIREWORKS  | –  | 1.2G  | 0334   |
| FIREWORKS  | –  | 1.3G  | 0335   |
| FIREWORKS  | –  | 1.4G  | 0336   |
| FIREWORKS  | –  | 1.4S  | 0337   |
| FIRST AID KIT  | –  | 9     | 3316   |
| FISH MEAL, STABILIZED anti-oxidant treated. Moisture content greater than 5% but not exceeding 12%, by mass. Fat content not more than 15%   | –  | 9     | 2216   |
| FISH MEAL, UNSTABILIZED. High hazard. Unrestricted moisture content. Unrestricted fat content in excess of 12%, by mass. Unrestricted fat content in excess of 15%, by mass, in the case of anti-oxidant treated fish meal   | –  | 4.2   | 1374   |
| FISH MEAL, UNSTABILIZED not anti-oxidant treated. Moisture content: more than 5% but not more than 12%, by mass. Fat content: not more than 12%, by mass   | –  | 4.2   | 1374   |
| FISH SCRAP, STABILIZED anti-oxidant treated. Moisture content greater than 5% but not exceeding 12%, by mass. Fat content not more than 15%  | –  | 9     | 2216   |
| FISH SCRAP, UNSTABILIZED. High hazard. Unrestricted moisture content. Unrestricted fat content in excess of 12%, by mass. Unrestricted fat content in excess of 15%, by mass, in the case of anti-oxidant treated fish scrap | –  | 4.2   | 1374   |
| FISH SCRAP, UNSTABILIZED not anti-oxidant treated. Moisture content: more than 5% but not more than 12%, by mass. Fat content: not more than 12%, by mass  | –  | 4.2   | 1374   |
| Flammable gas in lighters, see   | –  | 2.1   | 1057   |
| FLAMMABLE LIQUID, CORROSIVE, N.O.S.  | –  | 3     | 2924   |
| FLAMMABLE LIQUID, N.O.S.   | –  | 3     | 1993   |
| FLAMMABLE LIQUID, TOXIC, CORROSIVE, N.O.S.   | –  | 3     | 3286   |
| FLAMMABLE LIQUID, TOXIC, N.O.S.  | –  | 3     | 1992   |
| FLAMMABLE SOLID, CORROSIVE, INORGANIC, N.O.S.  | –  | 4.1   | 3180   |
| FLAMMABLE SOLID, CORROSIVE, ORGANIC, N.O.S.  | –  | 4.1   | 2925   |
| FLAMMABLE SOLID, INORGANIC, N.O.S.   | –  | 4.1   | 3178   |
| FLAMMABLE SOLID, ORGANIC, MOLTEN, N.O.S.   | –  | 4.1   | 3176   |

## Index

| Substance, material or article                                    | MP | Class | UN No. |
|---|----|-------|--------|
| FLAMMABLE SOLID, ORGANIC, N.O.S.                                  | –  | 4.1   | 1325   |
| FLAMMABLE SOLID, OXIDIZING, N.O.S.                                | –  | 4.1   | 3097   |
| FLAMMABLE SOLID, TOXIC, INORGANIC, N.O.S.                         | –  | 4.1   | 3179   |
| FLAMMABLE SOLID, TOXIC, ORGANIC, N.O.S.                           | –  | 4.1   | 2926   |
| FLARES, AERIAL  | –  | 1.1G  | 0420   |
| FLARES, AERIAL  | –  | 1.2G  | 0421   |
| FLARES, AERIAL  | –  | 1.3G  | 0093   |
| FLARES, AERIAL  | –  | 1.4G  | 0403   |
| FLARES, AERIAL  | –  | 1.4S  | 0404   |
| Flares, distress, small, <i>see</i> SIGNAL DEVICES, HAND          | –  | –     | –      |
| Flares, highway or railway, <i>see</i> SIGNAL DEVICES, HAND       | –  | –     | –      |
| FLARES, SURFACE   | –  | 1.1G  | 0418   |
| FLARES, SURFACE   | –  | 1.2G  | 0419   |
| FLARES, SURFACE   | –  | 1.3G  | 0092   |
| Flares, water-activated, <i>see</i> CONTRIVANCES, WATER-ACTIVATED | –  | –     | –      |
| FLASH POWDER  | –  | 1.1G  | 0094   |
| FLASH POWDER  | –  | 1.3G  | 0305   |
| Flax, dry, <i>see</i>   | –  | 4.1   | 3360   |
| Flowers of sulphur, <i>see</i>                                    | –  | 4.1   | 1350   |
| Flue dust, arsenical, <i>see</i>                                  | –  | 6.1   | 1562   |
| Fluoric acid, <i>see</i>  | –  | 8     | 1790   |
| Fluorine compounds (pesticides), <i>see</i> PESTICIDE, N.O.S.     | –  | –     | –      |
| FLUORINE, COMPRESSED  | –  | 2.3   | 1045   |
| Fluorine monoxide, compressed, <i>see</i>                         | –  | 2.3   | 2190   |
| Fluoroacetamide, <i>see</i> PESTICIDE, N.O.S.                     | –  | –     | –      |
| FLUOROACETIC ACID   | –  | 6.1   | 2642   |
| FLUOROANILINES  | –  | 6.1   | 2941   |
| FLUOROBENZENE   | –  | 3     | 2387   |
| FLUOROBORIC ACID  | –  | 8     | 1775   |
| Fluoroethane, <i>see</i>  | –  | 2.1   | 2453   |
| Fluoroethanoic acid, <i>see</i>                                   | –  | 6.1   | 2642   |
| Fluoroform, <i>see</i>  | –  | 2.2   | 1984   |
| Fluoroformyl fluoride, compressed, <i>see</i>                     | –  | 2.3   | 2417   |
| Fluoromethane, <i>see</i>   | –  | 2.1   | 2454   |
| FLUOROPHOSPHORIC ACID, ANHYDROUS                                  | –  | 8     | 1776   |
| FLUOROSILICATES, N.O.S.   | –  | 6.1   | 2856   |
| FLUOROSILICIC ACID  | –  | 8     | 1778   |
| FLUOROSULPHONIC ACID  | –  | 8     | 1777   |
| FLUOROTOLUENES  | –  | 3     | 2388   |
| Fonofos, <i>see</i> ORGANOPHOSPHORUS PESTICIDE                    | P  | –     | –      |
| Formal, <i>see</i>  | –  | 3     | 1234   |
| Formaldehyde dimethylacetal, <i>see</i>                           | –  | 3     | 1234   |

| Substance, material or article  | MP | Class | UN No. |
|---|----|-------|--------|
| FORMALDEHYDE SOLUTION, FLAMMABLE  | –  | 3     | 1198   |
| FORMALDEHYDE SOLUTION with not less than 25% formaldehyde                                 | –  | 8     | 2209   |
| Formalin solution, flammable, <i>see</i>  | –  | 3     | 1198   |
| Formalin solution with not less than 25% formaldehyde, <i>see</i>                         | –  | 8     | 2209   |
| Formamidine sulphinic acid, <i>see</i>  | –  | 4.2   | 3341   |
| Formetanate, <i>see</i> CARBAMATE PESTICIDE   | P  | –     | –      |
| Formic acid ethyl ester, <i>see</i>   | –  | 3     | 1190   |
| FORMIC ACID with more than 85% acid, by mass  | –  | 8     | 1779   |
| FORMIC ACID with not less than 5% but less than 10% acid, by mass                         | –  | 8     | 3412   |
| FORMIC ACID with not less than 10% but not more than 85% acid, by mass                    | –  | 8     | 3412   |
| Formic aldehyde solution, flammable, <i>see</i>   | –  | 3     | 1198   |
| Formothion, <i>see</i> ORGANOPHOSPHORUS PESTICIDE   | –  | –     | –      |
| 2-Formyl-3,4-dihydro-2 <i>H</i> -pyran, stabilized, <i>see</i>                            | –  | 3     | 2607   |
| <i>N</i> -Formyl-2-(nitromethylene)-1,3-perhydrothiazine (concentration 100%), <i>see</i> | –  | 4.1   | 3236   |
| FRACTURING DEVICES, EXPLOSIVE without detonator, for oil wells                            | –  | 1.1D  | 0099   |
| FUEL, AVIATION, TURBINE ENGINE  | –  | 3     | 1863   |
| FUEL CELL CARTRIDGES  | –  | 3     | 3473   |
| FUEL CELL CARTRIDGES, containing corrosive substances                                     | –  | 8     | 3477   |
| FUEL CELL CARTRIDGES, containing hydrogen in metal hydride                                | –  | 2.1   | 3479   |
| FUEL CELL CARTRIDGES, containing liquefied flammable gas                                  | –  | 2.1   | 3478   |
| FUEL CELL CARTRIDGES, containing water-reactive substances                                | –  | 4.3   | 3476   |
| FUEL CELL CARTRIDGES CONTAINED IN EQUIPMENT   | –  | 3     | 3473   |
| FUEL CELL CARTRIDGES CONTAINED IN EQUIPMENT, containing corrosive substances              | –  | 8     | 3477   |
| FUEL CELL CARTRIDGES CONTAINED IN EQUIPMENT, containing hydrogen in metal hydride         | –  | 2.1   | 3479   |
| FUEL CELL CARTRIDGES CONTAINED IN EQUIPMENT, containing liquefied flammable gas           | –  | 2.1   | 3478   |
| FUEL CELL CARTRIDGES CONTAINED IN EQUIPMENT, containing water-reactive substances         | –  | 4.3   | 3476   |
| FUEL CELL CARTRIDGES PACKED WITH EQUIPMENT, containing corrosive substances               | –  | 8     | 3477   |
| FUEL CELL CARTRIDGES PACKED WITH EQUIPMENT, containing hydrogen in metal hydride          | –  | 2.1   | 3479   |
| FUEL CELL CARTRIDGES PACKED WITH EQUIPMENT, containing liquefied flammable gas            | –  | 2.1   | 3478   |
| FUEL CELL CARTRIDGES PACKED WITH EQUIPMENT, containing water-reactive substances          | –  | 4.3   | 3476   |
| FUEL CELL CARTRIDGES PLACED WITH EQUIPMENT  | –  | 3     | 3473   |
| Fuel oil No. 1, <i>see</i>  | –  | 3     | 1223   |
| Fumaroyl dichloride, <i>see</i>   | –  | 8     | 1780   |
| FUMARYL CHLORIDE  | –  | 8     | 1780   |
| FUMIGATED CARGO TRANSPORT UNIT  | –  | 9     | 3359   |



Index

| Substance, material or article   | MP | Class | UN No. |
|--|----|-------|--------|
| FURALDEHYDES   | –  | 6.1   | 1199   |
| FURAN  | –  | 3     | 2389   |
| 2-Furanmethylamine, <i>see</i>   | –  | 3     | 2526   |
| Furathiocarb (ISO), <i>see</i> CARBAMATE PESTICIDE                                     | P  | –     | –      |
| Furfuran, <i>see</i>   | –  | 3     | 2389   |
| FURFURYL ALCOHOL   | –  | 6.1   | 2874   |
| FURFURYLAMINE  | –  | 3     | 2526   |
| <i>alpha</i> -Furfurylamine, <i>see</i>  | –  | 3     | 2526   |
| 2-Furyl carbinol, <i>see</i>   | –  | 6.1   | 2874   |
| FUSE, DETONATING, metal-clad   | –  | 1.1D  | 0290   |
| FUSE, DETONATING, metal-clad   | –  | 1.2D  | 0102   |
| FUSE, DETONATING, MILD EFFECT, metal-clad  | –  | 1.4D  | 0104   |
| FUSE, IGNITER, tubular, metal-clad   | –  | 1.4G  | 0103   |
| FUSEL OIL  | –  | 3     | 1201   |
| FUSE, NON-DETONATING   | –  | 1.3G  | 0101   |
| FUSE, SAFETY   | –  | 1.4S  | 0105   |
| Fuze, combination, percussion or time, <i>see</i> FUZES, DETONATING or FUZES, IGNITING | –  | –     | –      |
| FUZES, DETONATING  | –  | 1.1B  | 0106   |
| FUZES, DETONATING  | –  | 1.2B  | 0107   |
| FUZES, DETONATING  | –  | 1.4B  | 0257   |
| FUZES, DETONATING  | –  | 1.4S  | 0367   |
| FUZES, DETONATING with protective features   | –  | 1.1D  | 0408   |
| FUZES, DETONATING with protective features   | –  | 1.2D  | 0409   |
| FUZES, DETONATING with protective features   | –  | 1.4D  | 0410   |
| FUZES, IGNITING  | –  | 1.3G  | 0316   |
| FUZES, IGNITING  | –  | 1.4G  | 0317   |
| FUZES, IGNITING  | –  | 1.4S  | 0368   |
| GALLIUM  | –  | 8     | 2803   |
| ■ GALLIUM CONTAINED IN MANUFACTURED ARTICLES   | –  | 8     | 3554   |
| GAS CARTRIDGES without a release device, non-refillable                                | –  | 2     | 2037   |
| Gas drips, hydrocarbon, <i>see</i> HYDROCARBONS, LIQUID, N.O.S.                        | –  | –     | –      |
| GAS OIL  | –  | 3     | 1202   |
| GASOLINE   | –  | 3     | 1203   |
| Gasoline, casinghead, <i>see</i>   | –  | 3     | 1203   |
| GAS, REFRIGERATED LIQUID, FLAMMABLE, N.O.S.  | –  | 2.1   | 3312   |
| GAS, REFRIGERATED LIQUID, N.O.S.   | –  | 2.2   | 3158   |
| GAS, REFRIGERATED LIQUID, OXIDIZING, N.O.S.  | –  | 2.2   | 3311   |
| GAS SAMPLE, NON-PRESSURIZED, FLAMMABLE, N.O.S., not refrigerated liquid                | –  | 2.1   | 3167   |
| GAS SAMPLE, NON-PRESSURIZED, TOXIC, FLAMMABLE, N.O.S., not refrigerated liquid         | –  | 2.3   | 3168   |

| Substance, material or article  | MP | Class | UN No. |
|---|----|-------|--------|
| GAS SAMPLE, NON-PRESSURIZED, TOXIC, N.O.S.,<br>not refrigerated liquid  | –  | 2.3   | 3169   |
| Gelatin, blasting, <i>see</i>   | –  | 1.1D  | 0081   |
| Gelatin dynamite, <i>see</i>  | –  | 1.1D  | 0081   |
| GENETICALLY MODIFIED MICROORGANISMS   | –  | 9     | 3245   |
| GENETICALLY MODIFIED ORGANISMS  | –  | 9     | 3245   |
| GERMANE   | –  | 2.3   | 2192   |
| GERMANE, ADSORBED   | –  | 2.3   | 3523   |
| Germanium hydride, <i>see</i>   | –  | 2.3   | 2192   |
| GLYCEROL <i>alpha</i> -MONOCHLOROHYDRIN   | –  | 6.1   | 2689   |
| Glycerol 1,3-dichlorohydrin, <i>see</i>   | –  | 6.1   | 2750   |
| Glycerol trinitrate (class 1), <i>see</i> NITROGLYCERIN (class 1)   | –  | –     | –      |
| Glyceryl trinitrate, <i>see</i>   | –  | 3     | 1204   |
| Glyceryl trinitrate (class 1), <i>see</i> NITROGLYCERIN (class 1)   | –  | –     | –      |
| Glycidal, <i>see</i>  | –  | 3     | 2622   |
| GLYCIDALDEHYDE  | –  | 3     | 2622   |
| Glycol chlorohydrin, <i>see</i>   | –  | 6.1   | 1135   |
| Glycol dimethyl ether, <i>see</i>   | –  | 3     | 2252   |
| GRENADES, hand or rifle, with bursting charge   | –  | 1.1D  | 0284   |
| GRENADES, hand or rifle, with bursting charge   | –  | 1.1F  | 0292   |
| GRENADES, hand or rifle, with bursting charge   | –  | 1.2D  | 0285   |
| GRENADES, hand or rifle, with bursting charge   | –  | 1.2F  | 0293   |
| Grenades, illuminating, <i>see</i> AMMUNITION, ILLUMINATING   | –  | –     | –      |
| GRENADES, PRACTICE, hand or rifle   | –  | 1.2G  | 0372   |
| GRENADES, PRACTICE, hand or rifle   | –  | 1.3G  | 0318   |
| GRENADES, PRACTICE, hand or rifle   | –  | 1.4G  | 0452   |
| GRENADES, PRACTICE, hand or rifle   | –  | 1.4S  | 0110   |
| Grenades, smoke, <i>see</i> AMMUNITION, SMOKE   | –  | –     | –      |
| Grignard solution, <i>see</i>   | –  | 4.3   | 1928   |
| GUANIDINE NITRATE   | –  | 5.1   | 1467   |
| GUANYL NITROSAMINOQUANYLIDENE HYDRAZINE, WETTED<br>with not less than 30% water, by mass  | –  | 1.1A  | 0113   |
| GUANYL NITROSAMINOQUANYLTETRAZENE, WETTED<br>with not less than 30% water, or mixture of alcohol and water,<br>by mass  | –  | 1.1A  | 0114   |
| GUNPOWDER, COMPRESSED   | –  | 1.1D  | 0028   |
| GUNPOWDER granular, or as a meal  | –  | 1.1D  | 0027   |
| GUNPOWDER, IN PELLETS   | –  | 1.1D  | 0028   |
| HAFNIUM POWDER, DRY   | –  | 4.2   | 2545   |
| HAFNIUM POWDER, WETTED with not less than 25% water<br>(a visible excess of water must be present)<br>(a) mechanically produced, particle size less than 53 microns | –  | 4.1   | 1326   |
| HAFNIUM POWDER, WETTED with not less than 25% water<br>(a visible excess of water must be present)<br>(b) chemically produced, particle size less than 840 microns  | –  | 4.1   | 1326   |

## Index

| Substance, material or article                      | MP | Class | UN No. |
|---|----|-------|--------|
| HAY   | –  | 4.1   | 1327   |
| HALOGENATED MONOMETHYLDIPHENYLMETHANES, LIQUID      | P  | 9     | 3151   |
| HALOGENATED MONOMETHYLDIPHENYLMETHANES, SOLID       | P  | 9     | 3152   |
| HEATING OIL, LIGHT                                  | –  | 3     | 1202   |
| Heavy hydrogen, <i>see</i>                          | –  | 2.1   | 1957   |
| Heavy hydrogen, compressed, <i>see</i>              | –  | 2.1   | 1957   |
| HELIUM, COMPRESSED                                  | –  | 2.2   | 1046   |
| HELIUM, REFRIGERATED LIQUID                         | –  | 2.2   | 1963   |
| Hemp, dry, <i>see</i>                               | –  | 4.1   | 3360   |
| Heptachlor, <i>see</i> ORGANOCHLORINE PESTICIDE     | P  | –     | –      |
| HEPTAFLUOROPROPANE                                  | –  | 2.2   | 3296   |
| <i>n</i> -HEPTALDEHYDE                              | –  | 3     | 3056   |
| Heptanal, <i>see</i>                                | –  | 3     | 3056   |
| HEPTANES  | P  | 3     | 1206   |
| 2-Heptanone, <i>see</i>                             | –  | 3     | 1110   |
| 4-Heptanone, <i>see</i>                             | –  | 3     | 2710   |
| <i>n</i> -HEPTENE                                   | –  | 3     | 2278   |
| Heptenophos, <i>see</i> ORGANOPHOSPHORUS PESTICIDE  | P  | –     | –      |
| Heptyl aldehyde, <i>see</i>                         | –  | 3     | 3056   |
| Heptylbenzene, <i>see</i>                           | P  | 9     | 3082   |
| Heptyl chloride, <i>see</i>                         | P  | 3     | 1993   |
| HETP, <i>see</i>                                    | P  | 6.1   | 1611   |
| HETP (and compressed gas, mixtures), <i>see</i>     | –  | 2.3   | 1612   |
| HEXACHLOROACETONE                                   | –  | 6.1   | 2661   |
| HEXACHLOROBENZENE                                   | –  | 6.1   | 2729   |
| HEXACHLOROBUTADIENE                                 | P  | 6.1   | 2279   |
| Hexachloro-1,3-butadiene, <i>see</i>                | P  | 6.1   | 2279   |
| 1,3-Hexachlorobutadiene, <i>see</i>                 | P  | 6.1   | 2279   |
| HEXACHLOROCYCLOPENTADIENE                           | –  | 6.1   | 2646   |
| Hexachlorophane, <i>see</i>                         | –  | 6.1   | 2875   |
| HEXACHLOROPHENE                                     | –  | 6.1   | 2875   |
| Hexachloro-2-propanone, <i>see</i>                  | –  | 6.1   | 2661   |
| HEXADECYLTRICHLOROSILANE                            | –  | 8     | 1781   |
| 1,3-Hexadiene, <i>see</i>                           | –  | 3     | 2458   |
| 1,4-Hexadiene, <i>see</i>                           | –  | 3     | 2458   |
| 1,5-Hexadiene, <i>see</i>                           | –  | 3     | 2458   |
| 2,4-Hexadiene, <i>see</i>                           | –  | 3     | 2458   |
| HEXADIENES  | –  | 3     | 2458   |
| HEXAETHYL TETRAPHOSPHATE                            | P  | 6.1   | 1611   |
| HEXAETHYL TETRAPHOSPHATE AND COMPRESSED GAS MIXTURE | –  | 2.3   | 1612   |
| HEXAFLUOROACETONE                                   | –  | 2.3   | 2420   |
| HEXAFLUOROACETONE HYDRATE, LIQUID                   | –  | 6.1   | 2552   |
| HEXAFLUOROACETONE HYDRATE, SOLID                    | –  | 6.1   | 3436   |

| Substance, material or article   | MP | Class | UN No. |
|--|----|-------|--------|
| HEXAFLUOROETHANE   | –  | 2.2   | 2193   |
| HEXAFLUOROPHOSPHORIC ACID  | –  | 8     | 1782   |
| Hexafluoro-2-propanone, <i>see</i>   | –  | 2.3   | 2420   |
| HEXAFLUOROPROPYLENE  | –  | 2.2   | 1858   |
| Hexahydrobenzene, <i>see</i>   | –  | 3     | 1145   |
| Hexahydrocresol, <i>see</i>  | –  | 3     | 2617   |
| Hexahydromethylphenol, <i>see</i>  | –  | 3     | 2617   |
| Hexahydropyridine, <i>see</i>  | –  | 8     | 2401   |
| Hexahydrothiophenol, <i>see</i>  | –  | 3     | 3054   |
| Hexahydrotoluene, <i>see</i>   | –  | 3     | 2296   |
| HEXALDEHYDE  | –  | 3     | 1207   |
| Hexamethylene, <i>see</i>  | –  | 3     | 1145   |
| HEXAMETHYLENEDIAMINE, MOLTEN   | –  | 8     | 2280   |
| HEXAMETHYLENEDIAMINE, SOLID  | –  | 8     | 2280   |
| HEXAMETHYLENEDIAMINE SOLUTION  | –  | 8     | 1783   |
| HEXAMETHYLENE DIISOCYANATE   | –  | 6.1   | 2281   |
| HEXAMETHYLENEIMINE   | –  | 3     | 2493   |
| HEXAMETHYLENETETRAMINE   | –  | 4.1   | 1328   |
| Hexamine, <i>see</i>   | –  | 4.1   | 1328   |
| Hexane, <i>see</i>   | P  | 3     | 1208   |
| 1,6-Hexanediamine, solid, <i>see</i>   | –  | 8     | 2280   |
| 1,6-Hexanediamine solution, <i>see</i>   | –  | 8     | 1783   |
| HEXANES  | P  | 3     | 1208   |
| HEXANITRODIPHENYLAMINE   | –  | 1.1D  | 0079   |
| Hexanitrodiphenyl sulphide, wetted, <i>see</i>   | –  | 4.1   | 2852   |
| HEXANITROSTILBENE  | –  | 1.1D  | 0392   |
| Hexanoic acid, <i>see</i>  | –  | 8     | 2829   |
| HEXANOLS   | –  | 3     | 2282   |
| 1-HEXENE   | –  | 3     | 2370   |
| HEXOGEN AND CYCLOTETRAMETHYLENETETRANITRAMINE MIXTURE, DESENSITIZED with not less than 10% phlegmatizer, by mass | –  | 1.1D  | 0391   |
| HEXOGEN AND CYCLOTETRAMETHYLENETETRANITRAMINE MIXTURE, WETTED with not less than 15% water, by mass              | –  | 1.1D  | 0391   |
| HEXOGEN AND HMX MIXTURE, DESENSITIZED with not less than 10% phlegmatizer, by mass                               | –  | 1.1D  | 0391   |
| HEXOGEN AND HMX MIXTURE, WETTED with not less than 15% water, by mass  | –  | 1.1D  | 0391   |
| HEXOGEN AND OCTOGEN MIXTURE, DESENSITIZED with not less than 10% phlegmatizer, by mass                           | –  | 1.1D  | 0391   |
| HEXOGEN AND OCTOGEN MIXTURE, WETTED with not less than 15% water, by mass  | –  | 1.1D  | 0391   |
| HEXOGEN, DESENSITIZED  | –  | 1.1D  | 0483   |
| HEXOGEN, WETTED with not less than 15% water, by mass  | –  | 1.1D  | 0072   |
| Hexoic acid, <i>see</i>  | –  | 8     | 2829   |

## Index

| Substance, material or article  | MP | Class | UN No. |
|---|----|-------|--------|
| HEXOLITE, dry or wetted with less than 15% water, by mass   | –  | 1.1D  | 0118   |
| Hexone, <i>see</i>  | –  | 3     | 1245   |
| HEXOTOL, dry or wetted with less than 15% water, by mass  | –  | 1.1D  | 0118   |
| HEXOTONAL   | –  | 1.1D  | 0393   |
| HEXOTONAL cast, <i>see</i>  | –  | 1.1D  | 0393   |
| HEXYL   | –  | 1.1D  | 0079   |
| Hexyl acetate, <i>see</i>   | –  | 3     | 1233   |
| Hexyl aldehyde, <i>see</i>  | –  | 3     | 1207   |
| Hexylbenzene, <i>see</i>  | P  | 9     | 3082   |
| Hexyl chloride, <i>see</i>  | P  | 3     | 1993   |
| <i>alpha</i> -Hexylene, <i>see</i>  | –  | 3     | 2370   |
| Hexylic acid, <i>see</i>  | –  | 8     | 2829   |
| <i>tert</i> -Hexyl peroxyneodecanoate (concentration ≤ 71%, with diluent Type A), <i>see</i>          | –  | 5.2   | 3115   |
| <i>tert</i> -Hexyl peroxy-pivalate (concentration ≤ 52%, as a stable dispersion in water), <i>see</i> | –  | 5.2   | 3117   |
| <i>tert</i> -Hexyl peroxy-pivalate (concentration ≤ 72%, with diluent Type B), <i>see</i>             | –  | 5.2   | 3115   |
| HEXYLTRICHLOROSILANE  | –  | 8     | 1784   |
| HMDI, <i>see</i>  | –  | 6.1   | 2281   |
| HMX, DESENSITIZED   | –  | 1.1D  | 0484   |
| HMX AND RDX MIXTURE, WETTED with not less than 15% water, by mass                                     | –  | 1.1D  | 0391   |
| HMX AND RDX MIXTURE, DESENSITIZED with not less than 10% phlegmatizer, by mass                        | –  | 1.1D  | 0391   |
| HMX, WETTED with not less than 15% water, by mass   | –  | 1.1D  | 0226   |
| HYDRAZINE, ANHYDROUS  | –  | 8     | 2029   |
| HYDRAZINE AQUEOUS SOLUTION, FLAMMABLE with more than 37% hydrazine, by mass                           | –  | 8     | 3484   |
| HYDRAZINE, AQUEOUS SOLUTION with more than 37% hydrazine, by mass                                     | –  | 8     | 2030   |
| HYDRAZINE, AQUEOUS SOLUTION with not more than 37% hydrazine, by mass                                 | –  | 6.1   | 3293   |
| Hydrazine base, aqueous solution, <i>see</i>  | –  | 6.1   | 3293   |
| Hydrazine hydrate, <i>see</i>   | –  | 8     | 2030   |
| Hydrazinobenzene, <i>see</i>  | –  | 6.1   | 2572   |
| Hydrides, metal, water-reactive, N.O.S., <i>see</i>   | –  | 4.3   | 1409   |
| HYDRIODIC ACID  | –  | 8     | 1787   |
| Hydriodic acid, anhydrous, <i>see</i>   | –  | 2.3   | 2197   |
| HYDROBROMIC ACID  | –  | 8     | 1788   |
| HYDROCARBON GAS MIXTURE, COMPRESSED, N.O.S.   | –  | 2.1   | 1964   |
| HYDROCARBON GAS MIXTURE, LIQUEFIED, N.O.S.  | –  | 2.1   | 1965   |
| HYDROCARBON GAS REFILLS FOR SMALL DEVICES with release device   | –  | 2.1   | 3150   |
| HYDROCARBONS, LIQUID, N.O.S.  | –  | 3     | 3295   |
| HYDROCHLORIC ACID   | –  | 8     | 1789   |

| Substance, material or article  | MP | Class | UN No. |
|---|----|-------|--------|
| Hydrocyanic acid, anhydrous, stabilized, containing less than 3% water, see   | P  | 6.1   | 1051   |
| Hydrocyanic acid, anhydrous, stabilized, containing less than 3% water and absorbed in a porous inert material, see | P  | 6.1   | 1614   |
| HYDROCYANIC ACID, AQUEOUS SOLUTION with not more than 20% hydrogen cyanide  | P  | 6.1   | 1613   |
| HYDROCYANIC ACID with more than 20% acid, by mass (transport prohibited)  | –  | –     | –      |
| HYDROFLUORIC ACID AND SULPHURIC ACID MIXTURE  | –  | 8     | 1786   |
| Hydrofluoric acid, anhydrous, see   | –  | 8     | 1052   |
| HYDROFLUORIC ACID, with more than 60% hydrogen fluoride   | –  | 8     | 1790   |
| HYDROFLUORIC ACID, with not more than 60% hydrogen fluoride   | –  | 8     | 1790   |
| Hydrofluoroboric acid, see  | –  | 8     | 1775   |
| Hydrofluorosilicic acid, see  | –  | 8     | 1778   |
| HYDROGEN AND METHANE MIXTURE, COMPRESSED  | –  | 2.1   | 2034   |
| Hydrogen antimonide, see  | –  | 2.3   | 2676   |
| Hydrogen arsenide, see  | –  | 2.3   | 2188   |
| Hydrogen bromide, see   | –  | 8     | 1788   |
| HYDROGEN BROMIDE, ANHYDROUS   | –  | 2.3   | 1048   |
| Hydrogen bromide solution, see  | –  | 8     | 1788   |
| Hydrogencarboxylic acid, see  | –  | 8     | 1779   |
| Hydrogen chloride, see  | –  | 8     | 1789   |
| HYDROGEN CHLORIDE, ANHYDROUS  | –  | 2.3   | 1050   |
| HYDROGEN CHLORIDE, REFRIGERATED LIQUID (transport prohibited)   | –  | 2.3   | 2186   |
| HYDROGEN, COMPRESSED  | –  | 2.1   | 1049   |
| HYDROGEN CYANIDE, AQUEOUS SOLUTION with not more than 20% hydrogen cyanide  | P  | 6.1   | 1613   |
| HYDROGEN CYANIDE, SOLUTION IN ALCOHOL with more than 45% hydrogen cyanide (transport prohibited)                    | –  | –     | –      |
| HYDROGEN CYANIDE, SOLUTION IN ALCOHOL with not more than 45% hydrogen cyanide                                       | P  | 6.1   | 3294   |
| HYDROGEN CYANIDE, STABILIZED, containing less than 3% water   | P  | 6.1   | 1051   |
| HYDROGEN CYANIDE, STABILIZED, containing less than 3% water and absorbed in a porous inert material                 | P  | 6.1   | 1614   |
| HYDROGENDIFLUORIDES, SOLID, N.O.S.  | –  | 8     | 1740   |
| HYDROGENDIFLUORIDES SOLUTION, N.O.S.  | –  | 8     | 3471   |
| Hydrogen fluoride, see  | –  | 8     | 1790   |
| HYDROGEN FLUORIDE, ANHYDROUS  | –  | 8     | 1052   |
| Hydrogen fluoride solution, see   | –  | 8     | 1790   |
| HYDROGEN IN A METAL HYDRIDE STORAGE SYSTEM  | –  | 2.1   | 3468   |
| HYDROGEN IN A METAL HYDRIDE STORAGE SYSTEM CONTAINED IN EQUIPMENT   | –  | 2.1   | 3468   |
| HYDROGEN IN A METAL HYDRIDE STORAGE SYSTEM PACKED WITH EQUIPMENT  | –  | 2.1   | 3468   |
| Hydrogen iodide, see  | –  | 8     | 1787   |



## Index

| Substance, material or article   | MP | Class | UN No. |
|--|----|-------|--------|
| HYDROGEN IODIDE, ANHYDROUS   | –  | 2.3   | 2197   |
| HYDROGEN PEROXIDE AND PEROXYACETIC ACID MIXTURE with acid(s), water and not more than 5% peroxyacetic acid, STABILIZED       | –  | 5.1   | 3149   |
| HYDROGEN PEROXIDE, AQUEOUS SOLUTION, STABILIZED with more than 60% hydrogen peroxide   | –  | 5.1   | 2015   |
| HYDROGEN PEROXIDE, AQUEOUS SOLUTION with not less than 8% but less than 20% hydrogen peroxide (stabilized as necessary)      | –  | 5.1   | 2984   |
| HYDROGEN PEROXIDE, AQUEOUS SOLUTION with not less than 20% but not more than 60% hydrogen peroxide (stabilized as necessary) | –  | 5.1   | 2014   |
| Hydrogen peroxide carbamide, solid, <i>see</i>   | –  | 5.1   | 1511   |
| HYDROGEN PEROXIDE, STABILIZED  | –  | 5.1   | 2015   |
| Hydrogen phosphide, <i>see</i>   | –  | 2.3   | 2199   |
| HYDROGEN, REFRIGERATED LIQUID  | –  | 2.1   | 1966   |
| HYDROGEN SELENIDE, ADSORBED  | –  | 2.3   | 3526   |
| HYDROGEN SELENIDE, ANHYDROUS   | –  | 2.3   | 2202   |
| Hydrogen silicide, compressed, <i>see</i>  | –  | 2.1   | 2203   |
| Hydrogen sulphates, aqueous solution, <i>see</i>   | –  | 8     | 2837   |
| HYDROGEN SULPHIDE  | –  | 2.3   | 1053   |
| Hydroselenic acid, anhydrous, <i>see</i>   | –  | 2.3   | 2202   |
| Hydrosilicofluoric acid, <i>see</i>  | –  | 8     | 1778   |
| 1-HYDROXYBENZOTRIAZOLE, ANHYDROUS, dry or wetted with less than 20% water, by mass   | –  | 1.3C  | 0508   |
| 1-HYDROXYBENZOTRIAZOLE MONOHYDRATE   | –  | 4.1   | 3474   |
| 3-Hydroxybutanal, <i>see</i>   | –  | 6.1   | 2839   |
| 3-Hydroxybutan-2-one, <i>see</i>   | –  | 3     | 2621   |
| 3-Hydroxybutyraldehyde, <i>see</i>   | –  | 6.1   | 2839   |
| 2-Hydroxycamphane, <i>see</i>  | –  | 4.1   | 1312   |
| Hydroxydimethylbenzenes, liquid, <i>see</i>  | –  | 6.1   | 3430   |
| Hydroxydimethylbenzenes, solid, <i>see</i>   | –  | 6.1   | 2261   |
| 3-Hydroxy-1,1-dimethylbutyl peroxyneodecanoate (concentration ≤ 52%, as a stable dispersion in water)                        | –  | 5.2   | 3119   |
| 3-Hydroxy-1,1-dimethylbutyl peroxyneodecanoate (concentration ≤ 52%, with diluent Type A)                                    | –  | 5.2   | 3117   |
| 3-Hydroxy-1,1-dimethylbutyl peroxyneodecanoate (concentration ≤ 77%, with diluent Type A)                                    | –  | 5.2   | 3115   |
| 2-(2-Hydroxyethoxy)-1-(pyrrolidin-1-yl)benzene-4-diazonium zinc chloride (concentration 100%), <i>see</i>                    | –  | 4.1   | 3236   |
| 3-(2-Hydroxyethoxy)-4-(pyrrolidin-1-yl)benzenediazonium zinc chloride (concentration 100%), <i>see</i>                       | –  | 4.1   | 3236   |
| 2-Hydroxyethylamine, <i>see</i>  | –  | 8     | 2491   |
| HYDROXYLAMINE SULPHATE   | –  | 8     | 2865   |
| Hydroxylammonium sulphate, <i>see</i>  | –  | 8     | 2865   |
| 1-Hydroxy-3-methyl-2-penten-4-yne, <i>see</i>  | –  | 8     | 2705   |
| 3-Hydroxyphenol, <i>see</i>  | –  | 6.1   | 2876   |
| HYPOCHLORITES, INORGANIC, N.O.S.   | –  | 5.1   | 3212   |

| Substance, material or article                         | MP | Class | UN No. |
|--|----|-------|--------|
| HYPOCHLORITE SOLUTION                                  | P  | 8     | 1791   |
| IGNITERS   | –  | 1.1G  | 0121   |
| IGNITERS   | –  | 1.2G  | 0314   |
| IGNITERS   | –  | 1.3G  | 0315   |
| IGNITERS   | –  | 1.4G  | 0325   |
| IGNITERS   | –  | 1.4S  | 0454   |
| Imazalil, see PESTICIDE, N.O.S.                        | –  | –     | –      |
| 3,3'-IMINODIPROPYLAMINE                                | –  | 8     | 2269   |
| INFECTIOUS SUBSTANCE, AFFECTING ANIMALS only           | –  | 6.2   | 2900   |
| INFECTIOUS SUBSTANCE, AFFECTING HUMANS                 | –  | 6.2   | 2814   |
| Inflammable ... , see FLAMMABLE ...                    | –  | –     | –      |
| INSECTICIDE GAS, FLAMMABLE, N.O.S.                     | –  | 2.1   | 3354   |
| INSECTICIDE GAS, N.O.S.                                | –  | 2.2   | 1968   |
| INSECTICIDE GAS, TOXIC, FLAMMABLE, N.O.S.              | –  | 2.3   | 3355   |
| INSECTICIDE GAS, TOXIC, N.O.S.                         | –  | 2.3   | 1967   |
| IODINE   | –  | 8     | 3495   |
| IODINE MONOCHLORIDE, LIQUID                            | –  | 8     | 3498   |
| IODINE MONOCHLORIDE, SOLID                             | –  | 8     | 1792   |
| IODINE PENTAFLUORIDE                                   | –  | 5.1   | 2495   |
| 2-IODOBUTANE   | –  | 3     | 2390   |
| Iodomethane, see                                       | –  | 6.1   | 2644   |
| IODOMETHYLPROPANES                                     | –  | 3     | 2391   |
| IODOPROPANES   | –  | 3     | 2392   |
| <i>alpha</i> -Iodotoluene, see                         | –  | 6.1   | 2653   |
| Ioxynil, see PESTICIDE, N.O.S.                         | P  | –     | –      |
| Iprobenfos, see ORGANOPHOSPHORUS PESTICIDE             | –  | –     | –      |
| Iron carbonyl, see                                     | –  | 6.1   | 1994   |
| Iron chloride, anhydrous, see                          | –  | 8     | 1773   |
| Iron(III) chloride, anhydrous, see                     | –  | 8     | 1773   |
| Iron chloride solution, see                            | –  | 8     | 2582   |
| IRON OXIDE, SPENT obtained from coal gas purification  | –  | 4.2   | 1376   |
| IRON PENTACARBONYL                                     | –  | 6.1   | 1994   |
| Iron perchloride, anhydrous, see                       | –  | 8     | 1773   |
| Iron perchloride solution, see                         | –  | 8     | 2582   |
| ⊗ Iron powder, pyrophoric, see                         | –  | 4.2   | 1383   |
| IRON SPONGE, SPENT obtained from coal gas purification | –  | 4.2   | 1376   |
| Iron swarf, see  | –  | 4.2   | 2793   |
| Iron trichloride, anhydrous, see                       | –  | 8     | 1773   |
| Iron trichloride solution, see                         | –  | 8     | 2582   |
| Isoamyl acetate, see                                   | –  | 3     | 1104   |
| Isoamyl alcohol, see                                   | –  | 3     | 1105   |

## Index

| Substance, material or article                                      | MP | Class | UN No. |
|---|----|-------|--------|
| Isoamyl bromide, <i>see</i>   | –  | 3     | 2341   |
| Isoamyl butyrate, <i>see</i>  | –  | 3     | 2620   |
| <i>alpha</i> -Isoamylene, <i>see</i>                                | –  | 3     | 2561   |
| Isoamyl formate, <i>see</i>   | –  | 3     | 1109   |
| Isoamyl mercaptan, <i>see</i>                                       | –  | 3     | 1111   |
| Isoamyl nitrate, <i>see</i>   | –  | 3     | 1112   |
| Isoamyl nitrite, <i>see</i>   | –  | 3     | 1113   |
| Isobenzan, <i>see</i> ORGANOCHLORINE PESTICIDE                      | P  | –     | –      |
| Isobutanal, <i>see</i>  | –  | 3     | 2045   |
| ISOBUTANE   | –  | 2.1   | 1969   |
| ISOBUTANOL  | –  | 3     | 1212   |
| Isobutene, <i>see</i>   | –  | 2.1   | 1055   |
| Isobutenol, <i>see</i>  | –  | 3     | 2614   |
| Isobutenyl chloride, <i>see</i>                                     | –  | 3     | 2554   |
| ISOBUTYL ACETATE  | –  | 3     | 1213   |
| ISOBUTYL ACRYLATE, STABILIZED                                       | –  | 3     | 2527   |
| ISOBUTYL ALCOHOL  | –  | 3     | 1212   |
| ISOBUTYL ALDEHYDE   | –  | 3     | 2045   |
| ISOBUTYLAMINE   | –  | 3     | 1214   |
| Isobutylbenzene, <i>see</i>   | P  | 3     | 2709   |
| Isobutyl bromide, <i>see</i>  | –  | 3     | 2342   |
| ISOBUTYLENE   | –  | 2.1   | 1055   |
| ISOBUTYL FORMATE  | –  | 3     | 2393   |
| Isobutyl iodide, <i>see</i>   | –  | 3     | 2391   |
| ISOBUTYL ISOBUTYRATE  | –  | 3     | 2528   |
| ISOBUTYL ISOCYANATE   | –  | 6.1   | 2486   |
| Isobutyl mercaptan, <i>see</i>                                      | –  | 3     | 2347   |
| ISOBUTYL METHACRYLATE, STABILIZED                                   | –  | 3     | 2283   |
| ISOBUTYL PROPIONATE   | –  | 3     | 2394   |
| Isobutyl vinyl ether, <i>see</i>                                    | –  | 3     | 1304   |
| ISOBUTYRALDEHYDE  | –  | 3     | 2045   |
| ISOBUTYRIC ACID   | –  | 3     | 2529   |
| ISOBUTYRONITRILE  | –  | 3     | 2284   |
| ISOBUTYRYL CHLORIDE   | –  | 3     | 2395   |
| ISOCYANATES, FLAMMABLE, TOXIC, N.O.S.                               | –  | 3     | 2478   |
| ISOCYANATE SOLUTION, FLAMMABLE, TOXIC, N.O.S.                       | –  | 3     | 2478   |
| ISOCYANATE SOLUTION, TOXIC, FLAMMABLE, N.O.S.                       | –  | 6.1   | 3080   |
| ISOCYANATE SOLUTION, TOXIC, N.O.S.                                  | –  | 6.1   | 2206   |
| ISOCYANATES, TOXIC, FLAMMABLE, N.O.S.                               | –  | 6.1   | 3080   |
| ISOCYANATES, TOXIC, N.O.S.  | –  | 6.1   | 2206   |
| ISOCYANATOBENZOTRIFLUORIDES   | –  | 6.1   | 2285   |
| 3-Isocyanatomethyl-3,5,5-trimethylcyclohexyl isocyanate, <i>see</i> | –  | 6.1   | 2290   |
| Isodecyl acrylate, <i>see</i>                                       | P  | 9     | 3082   |

| Substance, material or article  | MP | Class | UN No. |
|---|----|-------|--------|
| Isododecane, <i>see</i>   | –  | 3     | 2286   |
| Isodrin, <i>see</i> ORGANOCHLORINE PESTICIDE  | –  | –     | –      |
| Isufenphos, <i>see</i> ORGANOPHOSPHORUS PESTICIDE   | P  | –     | –      |
| ISOHEPTENES   | –  | 3     | 2287   |
| ISOHEXENES  | –  | 3     | 2288   |
| Isolan, <i>see</i> CARBAMATE PESTICIDE  | –  | –     | –      |
| Isooctaldehyde, <i>see</i>  | –  | 3     | 1191   |
| Isooctane, <i>see</i>   | P  | 3     | 1262   |
| ISOOCTENES  | –  | 3     | 1216   |
| Isooctyl nitrate, <i>see</i>  | P  | 9     | 3082   |
| Isopentane, <i>see</i>  | –  | 3     | 1265   |
| ISOPENTENES   | –  | 3     | 2371   |
| Isopentylamine, <i>see</i>  | –  | 3     | 1106   |
| Isopentyl nitrite, <i>see</i>   | –  | 3     | 1113   |
| ISOPHORONEDIAMINE   | –  | 8     | 2289   |
| ISOPHORONE DIISOCYANATE   | –  | 6.1   | 2290   |
| ISOPRENE, STABILIZED  | P  | 3     | 1218   |
| Isoprocarb, <i>see</i> CARBAMATE PESTICIDE  | P  | –     | –      |
| ISOPROPANOL   | –  | 3     | 1219   |
| ISOPROPENYL ACETATE   | –  | 3     | 2403   |
| △ ISOPROPENYLBENZENE  | P  | 3     | 2303   |
| Isopropenyl carbinol, <i>see</i>  | –  | 3     | 2614   |
| Isopropenyl chloride, <i>see</i>  | –  | 3     | 2456   |
| 2-Isopropoxypropane, <i>see</i>   | –  | 3     | 1159   |
| ISOPROPYL ACETATE   | –  | 3     | 1220   |
| ISOPROPYL ACID PHOSPHATE  | –  | 8     | 1793   |
| ISOPROPYL ALCOHOL   | –  | 3     | 1219   |
| ISOPROPYLAMINE  | –  | 3     | 1221   |
| ISOPROPYLBENZENE  | –  | 3     | 1918   |
| Isopropyl bromide, <i>see</i>   | –  | 3     | 2344   |
| Isopropyl <i>sec</i> -butyl peroxydicarbonate (concentration ≤ 32%)<br>with di- <i>sec</i> -butyl peroxydicarbonate (concentration ≤ 15–18%) and<br>di-isopropyl peroxydicarbonate (concentration ≤ 12–15%),<br>with diluent Type A, <i>see</i> | –  | 5.2   | 3115   |
| Isopropyl <i>sec</i> -butyl peroxydicarbonate (concentration ≤ 52%)<br>with di- <i>sec</i> -butyl peroxydicarbonate (concentration ≤ 28%) and<br>di-isopropyl peroxydicarbonate (concentration ≤ 22%), <i>see</i>                               | –  | 5.2   | 3111   |
| ISOPROPYL BUTYRATE  | –  | 3     | 2405   |
| Isopropyl carbinol, <i>see</i>  | –  | 3     | 1212   |
| Isopropyl chloride, <i>see</i>  | –  | 3     | 2356   |
| ISOPROPYL CHLOROACETATE   | –  | 3     | 2947   |
| Isopropyl chlorocarbonate, <i>see</i>   | –  | 6.1   | 2407   |
| ISOPROPYL CHLOROFORMATE   | –  | 6.1   | 2407   |
| Isopropyl chloromethanoate, <i>see</i>  | –  | 6.1   | 2407   |
| ISOPROPYL 2-CHLOROPROPIONATE  | –  | 3     | 2934   |

## Index

| Substance, material or article  | MP | Class | UN No. |
|---|----|-------|--------|
| <i>alpha</i> -Isopropyl <i>alpha</i> -chloropropionate, see   | –  | 3     | 2934   |
| Isopropylcumyl hydroperoxide (concentration ≤ 72%, with diluent Type A), see                                | –  | 5.2   | 3109   |
| Isopropyl cyanide, see  | –  | 3     | 2284   |
| Isopropyl ether, see  | –  | 3     | 1159   |
| Isopropylethylene, see  | –  | 3     | 2561   |
| Isopropyl formate, see  | –  | 3     | 1281   |
| Isopropylideneacetone, see  | –  | 3     | 1229   |
| ISOPROPYL ISOBUTYRATE   | –  | 3     | 2406   |
| ISOPROPYL ISOCYANATE  | –  | 6.1   | 2483   |
| Isopropyl mercaptan, see  | –  | 3     | 2402   |
| Isopropyl methanoate, see   | –  | 3     | 1281   |
| ISOPROPYL NITRATE   | –  | 3     | 1222   |
| ISOPROPYL PROPIONATE  | –  | 3     | 2409   |
| Isopropyltoluene, see   | P  | 3     | 2046   |
| Isopropyltoluol, see  | P  | 3     | 2046   |
| ISOSORBIDE-5-MONONITRATE  | –  | 4.1   | 3251   |
| ISOSORBIDE DINITRATE MIXTURE with not less than 60% lactose, mannose, starch, or calcium hydrogen phosphate | –  | 4.1   | 2907   |
| Isotetramethylbenzene, see  | P  | 9     | 3082   |
| Isothioate, see ORGANOPHOSPHORUS PESTICIDE  | –  | –     | –      |
| Isovaleraldehyde, see   | –  | 3     | 2058   |
| Isovalerone, see  | –  | 3     | 1157   |
| Isoxathion, see ORGANOPHOSPHORUS PESTICIDE  | P  | –     | –      |
|   |    |       |        |
| JET PERFORATING GUNS, CHARGED, oil well, without detonator  | –  | 1.1D  | 0124   |
| JET PERFORATING GUNS, CHARGED, oil well, without detonator  | –  | 1.4D  | 0494   |
| Jet tappers, without detonator, see CHARGES, SHAPED, COMMERCIAL   | –  | –     | –      |
| Jute, dry, see  | –  | 4.1   | 3360   |
|   |    |       |        |
| Kapok, dry, see   | –  | 4.1   | 3360   |
| Kelevan, see ORGANOCHLORINE PESTICIDE   | –  | –     | –      |
| KEROSENE  | –  | 3     | 1223   |
| Kerosine, see   | –  | 3     | 1223   |
| KETONES, LIQUID, N.O.S.   | –  | 3     | 1224   |
| KRILL MEAL  | –  | 4.2   | 3497   |
| KRYPTON, COMPRESSED   | –  | 2.2   | 1056   |
| KRYPTON, REFRIGERATED LIQUID  | –  | 2.2   | 1970   |
|   |    |       |        |
| Lacquer, see PAINT  | –  | –     | –      |
| Lacquer base, liquid, see PAINT   | –  | –     | –      |
| Lacquer base solution, see  | –  | 3     | 2059   |
| LEAD ACETATE  | P  | 6.1   | 1616   |

| Substance, material or article   | MP | Class | UN No. |
|--|----|-------|--------|
| Lead and zinc calcines, <i>see</i>   | P  | 6.1   | 2291   |
| LEAD ARSENATES   | P  | 6.1   | 1617   |
| LEAD ARSENITES   | P  | 6.1   | 1618   |
| LEAD AZIDE, WETTED with not less than 20% water,<br>or mixture of alcohol and water, by mass               | –  | 1.1A  | 0129   |
| Lead chloride, solid, <i>see</i>   | P  | 6.1   | 2291   |
| LEAD COMPOUND, SOLUBLE, N.O.S.   | P  | 6.1   | 2291   |
| LEAD CYANIDE   | P  | 6.1   | 1620   |
| LEAD DIOXIDE   | –  | 5.1   | 1872   |
| Lead dross, <i>see</i>   | –  | 8     | 1794   |
| Lead(II) acetate, <i>see</i>   | –  | 6.1   | 1616   |
| Lead(II) cyanide, <i>see</i>   | –  | 6.1   | 1620   |
| LEAD NITRATE   | P  | 5.1   | 1469   |
| Lead(II) nitrate, <i>see</i> LEAD NITRATE  | –  | –     | –      |
| Lead(II) perchlorate, <i>see</i>   | –  | 5.1   | 1470   |
| LEAD PERCHLORATE, SOLID  | P  | 5.1   | 1470   |
| LEAD PERCHLORATE SOLUTION  | P  | 5.1   | 3408   |
| Lead peroxide, <i>see</i>  | –  | 5.1   | 1872   |
| LEAD PHOSPHITE, DIBASIC  | –  | 4.1   | 2989   |
| LEAD STYPHNATE, WETTED with not less than 20% water,<br>or mixture of alcohol and water, by mass           | –  | 1.1A  | 0130   |
| LEAD SULPHATE with more than 3% free acid  | –  | 8     | 1794   |
| Lead tetraethyl, <i>see</i>  | P  | 6.1   | 1649   |
| Lead tetramethyl, <i>see</i>   | P  | 6.1   | 1649   |
| LEAD TRINITRORESORCINATE, WETTED with not less than<br>20% water, or mixture of alcohol and water, by mass | –  | 1.1A  | 0130   |
| LIFE-SAVING APPLIANCES NOT SELF-INFLATING containing<br>dangerous goods as equipment                       | –  | 9     | 3072   |
| LIFE-SAVING APPLIANCES, SELF-INFLATING   | –  | 9     | 2990   |
| LIGHTER REFILLS containing flammable gas   | –  | 2.1   | 1057   |
| LIGHTERS containing flammable gas  | –  | 2.1   | 1057   |
| LIGHTERS, FUSE   | –  | 1.4S  | 0131   |
| Ligroin, <i>see</i> PETROLEUM DISTILLATES, N.O.S. <i>or see</i><br>PETROLEUM PRODUCTS, N.O.S.              | –  | –     | –      |
| Limonene, <i>see</i>   | P  | 3     | 2052   |
| Lindane, <i>see</i> ORGANOCHLORINE PESTICIDE   | P  | –     | –      |
| Linuron, <i>see</i> <b>Note 1</b>  | P  | –     | –      |
| LIQUEFIED GASES non-flammable, charged with nitrogen,<br>carbon dioxide or air                             | –  | 2.2   | 1058   |
| LIQUEFIED GAS, FLAMMABLE, N.O.S.   | –  | 2.1   | 3161   |
| LIQUEFIED GAS, N.O.S.  | –  | 2.2   | 3163   |
| LIQUEFIED GAS, OXIDIZING, N.O.S.   | –  | 2.2   | 3157   |
| LIQUEFIED GAS, TOXIC, CORROSIVE, N.O.S.  | –  | 2.3   | 3308   |
| LIQUEFIED GAS, TOXIC, FLAMMABLE, CORROSIVE, N.O.S.   | –  | 2.3   | 3309   |
| LIQUEFIED GAS, TOXIC, FLAMMABLE, N.O.S.  | –  | 2.3   | 3160   |



## Index

| Substance, material or article  | MP | Class | UN No. |
|---|----|-------|--------|
| LIQUEFIED GAS, TOXIC, N.O.S.  | –  | 2.3   | 3162   |
| LIQUEFIED GAS, TOXIC, OXIDIZING, CORROSIVE, N.O.S.  | –  | 2.3   | 3310   |
| LIQUEFIED GAS, TOXIC, OXIDIZING, N.O.S.   | –  | 2.3   | 3307   |
| Liquefied petroleum gases, <i>see</i>   | –  | 2.1   | 1075   |
| Liquified natural gas, <i>see</i>   | –  | 2.1   | 1972   |
| LITHIUM   | –  | 4.3   | 1415   |
| Lithium alkyls, liquid, <i>see</i>  | –  | 4.2   | 3394   |
| Lithium alkyls, solid, <i>see</i>   | –  | 4.2   | 3393   |
| Lithium alloy (liquid), <i>see</i>  | –  | 2.1   | 1001   |
| LITHIUM ALUMINIUM HYDRIDE   | –  | 4.3   | 1410   |
| LITHIUM ALUMINIUM HYDRIDE, ETHEREAL   | –  | 4.3   | 1411   |
| Lithium amalgams, liquid, <i>see</i>  | –  | 4.3   | 1389   |
| Lithium amalgams, solid, <i>see</i>   | –  | 4.3   | 3401   |
| Lithium amide, <i>see</i>   | –  | 4.3   | 1390   |
| LITHIUM BATTERIES INSTALLED IN CARGO TRANSPORT UNIT<br>lithium ion batteries or lithium metal batteries | –  | 9     | 3536   |
| LITHIUM BOROHYDRIDE   | –  | 4.3   | 1413   |
| Lithium dispersions, <i>see</i>   | –  | 4.3   | 1391   |
| LITHIUM FERROSILICON  | –  | 4.3   | 2830   |
| LITHIUM HYDRIDE   | –  | 4.3   | 1414   |
| LITHIUM HYDRIDE, FUSED SOLID  | –  | 4.3   | 2805   |
| LITHIUM HYDROXIDE   | –  | 8     | 2680   |
| Lithium hydroxide, solid, <i>see</i>  | –  | 8     | 2680   |
| LITHIUM HYDROXIDE SOLUTION  | –  | 8     | 2679   |
| LITHIUM HYPOCHLORITE, DRY   | –  | 5.1   | 1471   |
| LITHIUM HYPOCHLORITE MIXTURE  | –  | 5.1   | 1471   |
| Lithium in cartouches, <i>see</i>   | –  | 4.3   | 1415   |
| LITHIUM ION BATTERIES (including lithium ion polymer batteries)   | –  | 9     | 3480   |
| LITHIUM ION BATTERIES CONTAINED IN EQUIPMENT<br>(including lithium ion polymer batteries)               | –  | 9     | 3481   |
| LITHIUM ION BATTERIES PACKED WITH EQUIPMENT<br>(including lithium ion polymer batteries)                | –  | 9     | 3481   |
| LITHIUM METAL BATTERIES (including lithium alloy batteries)   | –  | 9     | 3090   |
| LITHIUM METAL BATTERIES CONTAINED IN EQUIPMENT<br>(including lithium alloy batteries)                   | –  | 9     | 3091   |
| LITHIUM METAL BATTERIES PACKED WITH EQUIPMENT<br>(including lithium alloy batteries)                    | –  | 9     | 3091   |
| LITHIUM NITRATE   | –  | 5.1   | 2722   |
| LITHIUM NITRIDE   | –  | 4.3   | 2806   |
| LITHIUM PEROXIDE  | –  | 5.1   | 1472   |
| Lithium silicide, <i>see</i>  | –  | 4.3   | 1417   |
| LITHIUM SILICON   | –  | 4.3   | 1417   |
| LNG, <i>see</i>   | –  | 2.1   | 1972   |
| LONDON PURPLE   | P  | 6.1   | 1621   |
| LPG, <i>see</i>   | –  | 2.1   | 1075   |

| Substance, material or article  | MP | Class | UN No. |
|---|----|-------|--------|
| Lye, <i>see</i>   | –  | 8     | 1823   |
| M86 fuel, <i>see</i>  | –  | 3     | 3165   |
| MACHINERY, FUEL CELL, FLAMMABLE GAS POWERED                                   | –  | 2.1   | 3529   |
| MACHINERY, FUEL CELL, FLAMMABLE LIQUID POWERED                                | –  | 3     | 3528   |
| MACHINERY, INTERNAL COMBUSTION  | P  | 9     | 3530   |
| MACHINERY, INTERNAL COMBUSTION, FLAMMABLE GAS POWERED                         | –  | 2.1   | 3529   |
| MACHINERY, INTERNAL COMBUSTION, FLAMMABLE LIQUID POWERED                      | –  | 3     | 3528   |
| MAGNESIUM   | –  | 4.1   | 1869   |
| Magnesium alkyls, <i>see</i>  | –  | 4.2   | 3394   |
| Magnesium alloys, <i>see</i>  | –  | 4.3   | 1393   |
| MAGNESIUM ALLOYS POWDER   | –  | 4.3   | 1418   |
| MAGNESIUM ALLOYS with more than 50% magnesium in pellets, turnings or ribbons | –  | 4.1   | 1869   |
| MAGNESIUM ALUMINIUM PHOSPHIDE   | –  | 4.3   | 1419   |
| Magnesium amalgams, liquid, <i>see</i>  | –  | 4.3   | 1392   |
| Magnesium amalgams, solid, <i>see</i>   | –  | 4.3   | 3402   |
| MAGNESIUM ARSENATE  | P  | 6.1   | 1622   |
| Magnesium bisulphite solution, <i>see</i>                                     | –  | 8     | 2693   |
| MAGNESIUM BROMATE   | –  | 5.1   | 1473   |
| MAGNESIUM CHLORATE  | –  | 5.1   | 2723   |
| Magnesium chloride and chlorate mixture, <i>see</i>                           | –  | 5.1   | 1459   |
| MAGNESIUM DIAMIDE   | –  | 4.2   | 2004   |
| Magnesium diphenyl, <i>see</i>  | –  | 4.2   | 3393   |
| Magnesium dispersions, <i>see</i>   | –  | 4.3   | 1391   |
| MAGNESIUM FLUOROSILICATE  | –  | 6.1   | 2853   |
| MAGNESIUM GRANULES, COATED, particle size not less than 149 microns           | –  | 4.3   | 2950   |
| Magnesium hexafluorosilicate, <i>see</i>                                      | –  | 6.1   | 2853   |
| MAGNESIUM HYDRIDE   | –  | 4.3   | 2010   |
| MAGNESIUM NITRATE   | –  | 5.1   | 1474   |
| MAGNESIUM PERCHLORATE   | –  | 5.1   | 1475   |
| MAGNESIUM PEROXIDE  | –  | 5.1   | 1476   |
| MAGNESIUM PHOSPHIDE   | –  | 4.3   | 2011   |
| MAGNESIUM POWDER  | –  | 4.3   | 1418   |
| Magnesium scrap, <i>see</i>   | –  | 4.1   | 1869   |
| MAGNESIUM SILICIDE  | –  | 4.3   | 2624   |
| Magnesium silicofluoride, <i>see</i>  | –  | 6.1   | 2853   |
| Magnesium silicon, <i>see</i>   | –  | 4.3   | 2624   |
| MAGNETIZED MATERIAL   | –  | 9     | 2807   |
| Malathion, <i>see</i>   | P  | 9     | 3082   |
| MALEIC ANHYDRIDE  | –  | 8     | 2215   |

## Index

| Substance, material or article   | MP | Class | UN No. |
|--|----|-------|--------|
| MALEIC ANHYDRIDE, MOLTEN   | –  | 8     | 2215   |
| Malonodinitrile, <i>see</i>  | –  | 6.1   | 2647   |
| MALONONITRILE  | –  | 6.1   | 2647   |
| Mancozeb (ISO), <i>see</i>   | P  | 9     | 3077   |
| MANEB  | P  | 4.2   | 2210   |
| MANEB PREPARATION, STABILIZED against self-heating   | P  | 4.3   | 2968   |
| MANEB PREPARATION with not less than 60% Maneb   | P  | 4.2   | 2210   |
| MANEB, STABILIZED  | P  | 4.3   | 2968   |
| Manganese ethylene-bis-dithiocarbamate, <i>see</i>   | P  | 4.2   | 2210   |
| Manganese ethylene-1,2-bis-dithiocarbamate, <i>see</i>   | P  | 4.2   | 2210   |
| Manganese ethylene-bis-dithiocarbamate, stabilized, <i>see</i>   | P  | 4.3   | 2968   |
| Manganese ethylene-1,2-bis-dithiocarbamate, stabilized, <i>see</i>                                     | P  | 4.3   | 2968   |
| MANGANESE NITRATE  | –  | 5.1   | 2724   |
| Manganese(II) nitrate, <i>see</i>  | –  | 5.1   | 2724   |
| MANGANESE RESINATE   | –  | 4.1   | 1330   |
| Manganous nitrate, <i>see</i>  | –  | 5.1   | 2724   |
| MANNITOL HEXANITRATE, WETTED with not less than 40% water,<br>or mixture of alcohol and water, by mass | –  | 1.1D  | 0133   |
| MATCHES, FUSEE   | –  | 4.1   | 2254   |
| MATCHES, SAFETY (book, card or strike on box)  | –  | 4.1   | 1944   |
| MATCHES, “STRIKE ANYWHERE”   | –  | 4.1   | 1331   |
| MATCHES, WAX ‘VESTA’   | –  | 4.1   | 1945   |
| Meal, oily, <i>see</i>   | –  | 4.2   | 1386   |
| Mecarbam, <i>see</i> ORGANOPHOSPHORUS PESTICIDE  | P  | –     | –      |
| MEDICAL WASTE, CATEGORY A, AFFECTING ANIMALS only, solid   | –  | 6.2   | 3549   |
| MEDICAL WASTE, CATEGORY A, AFFECTING HUMANS, solid   | –  | 6.2   | 3549   |
| MEDICAL WASTE, N.O.S.  | –  | 6.2   | 3291   |
| MEDICINE, LIQUID, FLAMMABLE, TOXIC, N.O.S.   | –  | 3     | 3248   |
| MEDICINE, LIQUID, TOXIC, N.O.S.  | –  | 6.1   | 1851   |
| MEDICINE, SOLID, TOXIC, N.O.S.   | –  | 6.1   | 3249   |
| Medinoterb, <i>see</i> SUBSTITUTED NITROPHENOL PESTICIDE   | –  | –     | –      |
| <i>p</i> -Menthyl hydroperoxide (concentration ≤ 72%, with diluent Type A),<br><i>see</i>              | –  | 5.2   | 3109   |
| <i>p</i> -Menthyl hydroperoxide (concentration > 72–100%), <i>see</i>                                  | –  | 5.2   | 3105   |
| Mephosfolan, <i>see</i> ORGANOPHOSPHORUS PESTICIDE   | P  | –     | –      |
| MERCAPTAN MIXTURE, LIQUID, FLAMMABLE, N.O.S.   | –  | 3     | 3336   |
| MERCAPTAN MIXTURE, LIQUID, FLAMMABLE, TOXIC, N.O.S.  | –  | 3     | 1228   |
| MERCAPTAN MIXTURE, LIQUID, TOXIC, FLAMMABLE, N.O.S.  | –  | 6.1   | 3071   |
| MERCAPTANS, LIQUID, FLAMMABLE, N.O.S.  | –  | 3     | 3336   |
| MERCAPTANS, LIQUID, FLAMMABLE, TOXIC, N.O.S.   | –  | 3     | 1228   |
| MERCAPTANS, LIQUID, TOXIC, FLAMMABLE, N.O.S.   | –  | 6.1   | 3071   |
| Mercaptoacetic acid, <i>see</i>  | –  | 8     | 1940   |
| Mercaptodimethur, <i>see</i> CARBAMATE PESTICIDE   | P  | –     | –      |
| 2-Mercaptoethanol, <i>see</i>  | –  | 6.1   | 2966   |

| Substance, material or article  | MP | Class | UN No. |
|---|----|-------|--------|
| 2-Mercaptopropionic acid, <i>see</i>  | –  | 6.1   | 2936   |
| 5-MERCAPTOTETRAZOL-1-ACETIC ACID  | –  | 1.4C  | 0448   |
| Mercuric acetate, <i>see</i>  | P  | 6.1   | 1629   |
| Mercuric ammonium chloride, <i>see</i>  | P  | 6.1   | 1630   |
| MERCURIC ARSENATE   | P  | 6.1   | 1623   |
| Mercuric benzoate, <i>see</i>   | P  | 6.1   | 1631   |
| Mercuric bisulphate, <i>see</i>   | P  | 6.1   | 1645   |
| Mercuric bromide, <i>see</i>  | P  | 6.1   | 1634   |
| MERCURIC CHLORIDE   | P  | 6.1   | 1624   |
| Mercuric cyanide, <i>see</i>  | P  | 6.1   | 1636   |
| Mercuric gluconate, <i>see</i>  | P  | 6.1   | 1637   |
| Mercuric iodide, <i>see</i>   | P  | 6.1   | 1638   |
| MERCURIC NITRATE  | P  | 6.1   | 1625   |
| Mercuric oleate, <i>see</i>   | P  | 6.1   | 1640   |
| Mercuric oxide, <i>see</i>  | P  | 6.1   | 1641   |
| Mercuric oxycyanide, desensitized, <i>see</i>                                       | P  | 6.1   | 1642   |
| MERCURIC POTASSIUM CYANIDE  | P  | 6.1   | 1626   |
| Mercuric sulphate, <i>see</i>   | P  | 6.1   | 1645   |
| Mercuric thiocyanate, <i>see</i>  | P  | 6.1   | 1646   |
| Mercuriol, <i>see</i>   | P  | 6.1   | 1639   |
| Mercurous acetate, <i>see</i>   | P  | 6.1   | 1629   |
| Mercurous bisulphate, <i>see</i>  | P  | 6.1   | 1645   |
| Mercurous bromide, <i>see</i>   | P  | 6.1   | 1634   |
| Mercurous chloride, <i>see</i>  | P  | 6.1   | 2025   |
| MERCUROUS NITRATE   | P  | 6.1   | 1627   |
| Mercurous salicylate, <i>see</i>  | P  | 6.1   | 1644   |
| Mercurous sulphate, <i>see</i>  | P  | 6.1   | 1645   |
| MERCURY   | –  | 8     | 2809   |
| MERCURY ACETATE   | P  | 6.1   | 1629   |
| MERCURY AMMONIUM CHLORIDE   | P  | 6.1   | 1630   |
| MERCURY BASED PESTICIDE, LIQUID, FLAMMABLE, TOXIC,<br>flashpoint less than 23°C     | P  | 3     | 2778   |
| MERCURY BASED PESTICIDE, LIQUID, TOXIC  | P  | 6.1   | 3012   |
| MERCURY BASED PESTICIDE, LIQUID, TOXIC, FLAMMABLE,<br>flashpoint not less than 23°C | P  | 6.1   | 3011   |
| MERCURY BASED PESTICIDE, SOLID, TOXIC   | P  | 6.1   | 2777   |
| MERCURY BENZOATE  | P  | 6.1   | 1631   |
| Mercury bichloride, <i>see</i>  | P  | 6.1   | 1624   |
| Mercury bisulphate, <i>see</i>  | P  | 6.1   | 1645   |
| MERCURY BROMIDES  | P  | 6.1   | 1634   |
| MERCURY COMPOUND, LIQUID, N.O.S.  | P  | 6.1   | 2024   |
| MERCURY COMPOUND, SOLID, N.O.S.   | P  | 6.1   | 2025   |
| MERCURY CONTAINED IN MANUFACTURED ARTICLES  | –  | 8     | 3506   |
| MERCURY CYANIDE   | P  | 6.1   | 1636   |

## Index

| Substance, material or article   | MP | Class | UN No. |
|--|----|-------|--------|
| MERCURY FULMINATE, WETTED with not less than 20% water, or mixture of alcohol and water, by mass | –  | 1.1A  | 0135   |
| MERCURY GLUCONATE  | P  | 6.1   | 1637   |
| Mercury(II) (mercuric) compounds, <i>see</i> MERCURY BASED PESTICIDE                             | P  | –     | –      |
| Mercury(I) (mercurous) compounds, <i>see</i> MERCURY BASED PESTICIDE                             | P  | –     | –      |
| MERCURY IODIDE   | P  | 6.1   | 1638   |
| MERCURY NUCLEATE   | P  | 6.1   | 1639   |
| MERCURY OLEATE   | P  | 6.1   | 1640   |
| MERCURY OXIDE  | –  | 6.1   | 1641   |
| MERCURY OXYCYANIDE, DESENSITIZED   | P  | 6.1   | 1642   |
| MERCURY OXYCYANIDE pure (transport prohibited)   | –  | –     | –      |
| Mercury potassium cyanide, <i>see</i>  | P  | 6.1   | 1626   |
| MERCURY POTASSIUM IODIDE   | P  | 6.1   | 1643   |
| MERCURY SALICYLATE   | P  | 6.1   | 1644   |
| MERCURY SULPHATE   | P  | 6.1   | 1645   |
| MERCURY THIOCYANATE  | P  | 6.1   | 1646   |
| Mesitylene, <i>see</i>   | P  | 3     | 2325   |
| MESITYL OXIDE  | –  | 3     | 1229   |
| Mesyl chloride, <i>see</i>   | –  | 6.1   | 3246   |
| Metaarsenic acid, <i>see</i>   | –  | 6.1   | 1554   |
| Metacetone, <i>see</i>   | –  | 3     | 1156   |
| Metal alkyl halides, water-reactive, n.o.s., <i>see</i>  | –  | 4.2   | 3394   |
| Metal alkyl hydrides, water-reactive, n.o.s., <i>see</i>   | –  | 4.2   | 3394   |
| Metal alkyls, water-reactive, n.o.s., <i>see</i>   | –  | 4.2   | 3394   |
| Metal aryl halides, water-reactive, n.o.s., <i>see</i>   | –  | 4.2   | 3394   |
| Metal aryl hydrides, water-reactive, n.o.s., <i>see</i>  | –  | 4.2   | 3394   |
| Metal aryls, water-reactive, n.o.s., <i>see</i>  | –  | 4.2   | 3394   |
| METAL CARBONYLS, LIQUID, N.O.S.  | –  | 6.1   | 3281   |
| METAL CARBONYLS, SOLID, N.O.S.   | –  | 6.1   | 3466   |
| METAL CATALYST, DRY  | –  | 4.2   | 2881   |
| METAL CATALYST, WETTED with a visible excess of liquid   | –  | 4.2   | 1378   |
| METALDEHYDE  | –  | 4.1   | 1332   |
| METAL HYDRIDES, FLAMMABLE, N.O.S.  | –  | 4.1   | 3182   |
| METAL HYDRIDES, WATER-REACTIVE, N.O.S.   | –  | 4.3   | 1409   |
| METALLIC SUBSTANCE, WATER-REACTIVE, N.O.S.   | –  | 4.3   | 3208   |
| METALLIC SUBSTANCE, WATER-REACTIVE, SELF-HEATING, N.O.S.   | –  | 4.3   | 3209   |
| METAL POWDER, FLAMMABLE, N.O.S.  | –  | 4.1   | 3089   |
| METAL POWDER, SELF-HEATING, N.O.S.   | –  | 4.2   | 3189   |
| METAL SALTS OF ORGANIC COMPOUNDS, FLAMMABLE, N.O.S.  | –  | 4.1   | 3181   |
| Metam-sodium, <i>see</i> THIOCARBAMATE PESTICIDE   | P  | –     | –      |
| Methacraldehyde, stabilized, <i>see</i>  | –  | 3     | 2396   |
| METHACRYLALDEHYDE, STABILIZED  | –  | 3     | 2396   |
| 3-Methacrylic acid, liquid, <i>see</i>   | –  | 8     | 3472   |

| Substance, material or article   | MP | Class | UN No. |
|--|----|-------|--------|
| 3-Methacrylic acid, solid, <i>see</i>  | –  | 8     | 2823   |
| METHACRYLIC ACID, STABILIZED   | –  | 8     | 2531   |
| METHACRYLONITRILE, STABILIZED  | –  | 6.1   | 3079   |
| METHALLYL ALCOHOL  | –  | 3     | 2614   |
| Methamidophos, <i>see</i> ORGANOPHOSPHORUS PESTICIDE   | P  | –     | –      |
| Methanal, <i>see</i>   | –  | 3     | 1198   |
| Methanal, <i>see</i>   | –  | 8     | 2209   |
| Methane and hydrogen, mixtures, compressed, <i>see</i>   | –  | 2.1   | 2034   |
| METHANE, COMPRESSED  | –  | 2.1   | 1971   |
| METHANE, REFRIGERATED LIQUID   | –  | 2.1   | 1972   |
| METHANESULPHONYL CHLORIDE  | –  | 6.1   | 3246   |
| Methanethiol, <i>see</i>   | P  | 2.3   | 1064   |
| METHANOL   | –  | 3     | 1230   |
| Methasulfocarb, <i>see</i> CARBAMATE PESTICIDE   | –  | –     | –      |
| Methidathion, <i>see</i> ORGANOPHOSPHORUS PESTICIDE  | P  | –     | –      |
| Methomyl, <i>see</i> CARBAMATE PESTICIDE   | P  | –     | –      |
| <i>ortho</i> -Methoxyaniline, <i>see</i>   | –  | 6.1   | 2431   |
| Methoxybenzene, <i>see</i>   | –  | 3     | 2222   |
| 1-Methoxybutane, <i>see</i>  | –  | 3     | 2350   |
| Methoxyethane, <i>see</i>  | –  | 2.1   | 1039   |
| 2-Methoxyethanol, <i>see</i>   | –  | 3     | 1188   |
| 2-Methoxyethyl acetate, <i>see</i>   | –  | 3     | 1189   |
| METHOXYMETHYL ISOCYANATE   | –  | 6.1   | 2605   |
| 4-METHOXY-4-METHYLPENTAN-2-ONE   | –  | 3     | 2293   |
| 4-Methoxy-4-methyl-2-pentanone, <i>see</i>   | –  | 3     | 2293   |
| (7-Methoxy-5-methyl-benzothiophen-2-yl) boronic acid<br>(concentration 88 to 100%), <i>see</i> | –  | 4.1   | 3230   |
| Methoxynitrobenzenes, liquid, <i>see</i>   | –  | 6.1   | 2730   |
| Methoxynitrobenzenes, solid, <i>see</i>  | –  | 6.1   | 3458   |
| 1-Methoxypropane, <i>see</i>   | –  | 3     | 2612   |
| 1-METHOXY-2-PROPANOL   | –  | 3     | 3092   |
| METHYL ACETATE   | –  | 3     | 1231   |
| Methylacetic acid, <i>see</i>  | –  | 8     | 1848   |
| METHYLACETYLENE AND PROPADIENE MIXTURE, STABILIZED   | –  | 2.1   | 1060   |
| <i>beta</i> -Methylacrolein, <i>see</i>  | P  | 6.1   | 1143   |
| 2-Methylacrolein, stabilized   | –  | 3     | 2396   |
| 3-Methylacrolein, stabilized, <i>see</i>   | P  | 6.1   | 1143   |
| METHYL ACRYLATE, STABILIZED  | –  | 3     | 1919   |
| METHYLAL   | –  | 3     | 1234   |
| Methyl alcohol, <i>see</i>   | –  | 3     | 1230   |
| Methyl allyl alcohol, <i>see</i>   | –  | 3     | 2614   |
| Methylallyl alcohol, <i>see</i>  | –  | 3     | 2614   |
| METHYLALLYL CHLORIDE   | –  | 3     | 2554   |



## Index

| Substance, material or article  | MP | Class | UN No. |
|---|----|-------|--------|
| METHYLAMINE, ANHYDROUS  | –  | 2.1   | 1061   |
| METHYLAMINE, AQUEOUS SOLUTION   | –  | 3     | 1235   |
| 2-( <i>N,N</i> -Methylaminoethylcarbonyl)-4-(3,4-dimethylphenylsulphonyl)benzenediazonium hydrogen sulphate (concentration 96%), <i>see</i> | –  | 4.1   | 3236   |
| METHYLAMYL ACETATE  | –  | 3     | 1233   |
| Methyl amyl alcohol, <i>see</i>   | –  | 3     | 2053   |
| Methylamyl alcohol, <i>see</i>  | –  | 3     | 2053   |
| Methyl <i>normal</i> -amyl ketone, <i>see</i>   | –  | 3     | 1110   |
| <i>N</i> -METHYLANILINE   | P  | 6.1   | 2294   |
| Methylated spirits, <i>see</i>  | –  | 3     | 1987   |
| Methylated spirits, <i>see</i>  | –  | 3     | 1986   |
| Methylbenzene, <i>see</i>   | –  | 3     | 1294   |
| 4-Methylbenzenesulphonylhydrazide (concentration 100%), <i>see</i>  | –  | 4.1   | 3226   |
| Methylbenzol, <i>see</i>  | –  | 3     | 1294   |
| <i>alpha</i> -METHYLBENZYL ALCOHOL, LIQUID  | –  | 6.1   | 2937   |
| <i>alpha</i> -METHYLBENZYL ALCOHOL, SOLID   | –  | 6.1   | 3438   |
| Methyl borate, <i>see</i>   | –  | 3     | 2416   |
| Methyl bromide and chloropicrin mixture, <i>see</i>   | –  | 2.3   | 1581   |
| METHYL BROMIDE AND ETHYLENE DIBROMIDE MIXTURE, LIQUID   | P  | 6.1   | 1647   |
| METHYL BROMIDE with not more than 2.0% chloropicrin   | –  | 2.3   | 1062   |
| METHYL BROMOACETATE   | –  | 6.1   | 2643   |
| 2-Methyl-1,3-butadiene, stabilized, <i>see</i>  | –  | 3     | 1218   |
| 2-METHYLBUTANAL   | –  | 3     | 3371   |
| 2-Methylbutane, <i>see</i>  | –  | 3     | 1265   |
| Methylbutanols, <i>see</i>  | –  | 3     | 1105   |
| 3-METHYLBUTAN-2-ONE   | –  | 3     | 2397   |
| 3-Methyl-2-butanone, <i>see</i>   | –  | 3     | 2397   |
| 2-METHYL-1-BUTENE   | –  | 3     | 2459   |
| 2-METHYL-2-BUTENE   | –  | 3     | 2460   |
| 3-METHYL-1-BUTENE   | –  | 3     | 2561   |
| 2-Methyl butylacrylate, stabilized, <i>see</i>  | –  | 3     | 2227   |
| <i>N</i> -METHYLBUTYLAMINE  | –  | 3     | 2945   |
| METHYL <i>tert</i> -BUTYL ETHER   | –  | 3     | 2398   |
| METHYL BUTYRATE   | –  | 3     | 1237   |
| Methyl carbonate, <i>see</i>  | –  | 3     | 1161   |
| METHYL CHLORIDE   | –  | 2.1   | 1063   |
| Methyl chloride and chloropicrin mixture, <i>see</i>  | –  | 2.3   | 1582   |
| METHYL CHLORIDE AND METHYLENE CHLORIDE MIXTURE  | –  | 2.1   | 1912   |
| METHYL CHLOROACETATE  | –  | 6.1   | 2295   |
| Methylchlorobenzenes, <i>see</i>  | –  | 3     | 2238   |
| Methyl chlorocarbonate, <i>see</i>  | –  | 6.1   | 1238   |
| Methyl chloroform, <i>see</i>   | –  | 6.1   | 2831   |
| Methylchloroform, <i>see</i>  | –  | 6.1   | 2831   |

| Substance, material or article  | MP | Class | UN No. |
|---|----|-------|--------|
| METHYL CHLOROFORMATE  | –  | 6.1   | 1238   |
| METHYL CHLOROMETHYL ETHER   | –  | 6.1   | 1239   |
| METHYL 2-CHLOROPROPIONATE   | –  | 3     | 2933   |
| <i>alpha</i> -Methyl <i>alpha</i> -chloropropionate, see  | –  | 3     | 2933   |
| METHYLCHLOROSILANE  | –  | 2.3   | 2534   |
| Methyl cyanide, see   | –  | 3     | 1648   |
| METHYLCYCLOHEXANE   | P  | 3     | 2296   |
| METHYLCYCLOHEXANOLS, flammable  | –  | 3     | 2617   |
| Methylcyclohexanone peroxide(s) (concentration ≤ 67%, with diluent Type B), see                                     | –  | 5.2   | 3115   |
| METHYLCYCLOHEXANONE   | –  | 3     | 2297   |
| METHYLCYCLOPENTANE  | –  | 3     | 2298   |
| METHYL DICHLOROACETATE  | –  | 6.1   | 2299   |
| METHYLDICHLOROSILANE  | –  | 4.3   | 1242   |
| Methyldinitrobenzenes, liquid, see  | P  | 6.1   | 2038   |
| Methyldinitrobenzenes, molten, see  | P  | 6.1   | 1600   |
| Methyldinitrobenzenes, solid, see   | P  | 6.1   | 3454   |
| Methyl disulphide, see  | P  | 3     | 2381   |
| Methyldithiomethane, see  | P  | 3     | 2381   |
| 2,2'-Methylenebis-(3,4,6-trichlorophenol), see  | –  | 6.1   | 2875   |
| Methylene bromide, see  | –  | 6.1   | 2664   |
| Methylene chloride, see   | –  | 6.1   | 1593   |
| Methylene chloride and methyl chloride mixture, see METHYL CHLORIDE AND METHYLENE CHLORIDE MIXTURE                  | –  | –     | –      |
| Methylene chlorobromide, see  | –  | 6.1   | 1887   |
| Methylene cyanide, see  | –  | 6.1   | 2647   |
| <i>p,p'</i> -Methylenedianiline, see  | P  | 6.1   | 2651   |
| Methylene dibromide, see  | –  | 6.1   | 2664   |
| Methyl ether, see   | –  | 2.1   | 1033   |
| Methyl ethyl carbinol, see  | –  | 3     | 1120   |
| Methyl ethyl ether, see   | –  | 2.1   | 1039   |
| METHYL ETHYL KETONE   | –  | 3     | 1193   |
| ■ Methyl ethyl ketone peroxyde(s) (available oxygen ≤ 10%, with diluant type A and water), see                      | –  | 5.2   | 3105   |
| Methyl ethyl ketone peroxide(s) (concentration ≤ 40%, with diluent Type A, available oxygen ≤ 8.2%), see            | –  | 5.2   | 3107   |
| Methyl ethyl ketone peroxide(s) (concentration ≤ 45%, with diluent Type A, available oxygen ≤ 10%), see             | –  | 5.2   | 3105   |
| Methyl ethyl ketone peroxide(s) (concentration ≤ 52%, with diluent Type A, available oxygen > 10% and ≤ 10.7%), see | –  | 5.2   | 3101   |
| 2-METHYL-5-ETHYLPYRIDINE  | –  | 6.1   | 2300   |
| METHYL FLUORIDE   | –  | 2.1   | 2454   |
| Methylfluorobenzenes ( <i>ortho</i> -; <i>meta</i> -; <i>para</i> -), see   | –  | 3     | 2388   |
| METHYL FORMATE  | –  | 3     | 1243   |
| 2-METHYLFURAN   | –  | 3     | 2301   |

## Index

| Substance, material or article  | MP | Class | UN No. |
|---|----|-------|--------|
| Methyl glycol, <i>see</i>   | –  | 3     | 1188   |
| Methyl glycol acetate, <i>see</i>   | –  | 3     | 1189   |
| 2-Methylheptane, <i>see</i>   | P  | 3     | 1262   |
| 2-METHYL-2-HEPTANETHIOL   | –  | 6.1   | 3023   |
| 5-METHYLHEXAN-2-ONE   | –  | 3     | 2302   |
| 5-Methyl-2-hexanone, <i>see</i>   | –  | 3     | 2302   |
| METHYLHYDRAZINE   | –  | 6.1   | 1244   |
| METHYL IODIDE   | –  | 6.1   | 2644   |
| Methyl isobutenyl ketone, <i>see</i>  | –  | 3     | 1229   |
| METHYL ISOBUTYL CARBINOL  | –  | 3     | 2053   |
| Methyl isobutyl carbinol acetate, <i>see</i>  | –  | 3     | 1233   |
| METHYL ISOBUTYL KETONE  | –  | 3     | 1245   |
| Methyl isobutyl ketone peroxide(s) (concentration $\leq$ 62%,<br>with $\geq$ 19% by mass diluent Type A and methyl isobutyl ketone), <i>see</i> | –  | 5.2   | 3105   |
| METHYL ISOCYANATE   | –  | 6.1   | 2480   |
| METHYL ISOPROPENYL KETONE, STABILIZED   | –  | 3     | 1246   |
| Methyl isopropyl ketone, <i>see</i>   | –  | 3     | 2397   |
| Methyl isopropyl ketone peroxide(s) (with diluent Type A and active<br>oxygen $\leq$ 6.7%)  | –  | 5.2   | 3109   |
| METHYL ISOTHIOCYANATE   | –  | 6.1   | 2477   |
| METHYL ISOVALERATE  | –  | 3     | 2400   |
| METHYLMAGNESIUM BROMIDE IN ETHYL ETHER  | –  | 4.3   | 1928   |
| METHYL MERCAPTAN  | P  | 2.3   | 1064   |
| Methyl mercaptopropionaldehyde, <i>see</i>  | –  | 6.1   | 2785   |
| METHYL METHACRYLATE MONOMER, STABILIZED   | –  | 3     | 1247   |
| 4-METHYLMORPHOLINE  | –  | 3     | 2535   |
| N-METHYLMORPHOLINE  | –  | 3     | 2535   |
| METHYL NITRITE (transport prohibited)   | –  | 2.2   | 2455   |
| Methylnitrophenols, <i>see</i>  | –  | 6.1   | 2446   |
| METHYL ORTHOSILICATE  | –  | 6.1   | 2606   |
| METHYLPENTADIENES   | –  | 3     | 2461   |
| 2-Methylpentane, <i>see</i>   | P  | 3     | 1208   |
| 3-Methylpentane, <i>see</i>   | –  | 3     | 1208   |
| 2-METHYLPENTAN-2-OL   | –  | 3     | 2560   |
| 4-Methylpentan-2-ol, <i>see</i>   | –  | 3     | 2053   |
| 4-Methyl-2-pentanone, <i>see</i>  | –  | 3     | 1245   |
| 4-Methyl-3-penten-2-one, <i>see</i>   | –  | 3     | 1229   |
| 3-Methyl-2-penten-4-yn-ol, <i>see</i>   | –  | 8     | 2705   |
| METHYLPHENYLDICHLOROSILANE  | –  | 8     | 2437   |
| Methyl phenyl ether, <i>see</i>   | –  | 3     | 2222   |
| 2-Methyl-2-phenylpropane, <i>see</i>  | P  | 3     | 2709   |
| 1-METHYLPYPERIDINE  | –  | 3     | 2399   |
| N-Methylpiperidine, <i>see</i>  | –  | 3     | 2399   |
| 2-Methylpropanol-1, <i>see</i>  | –  | 3     | 1212   |

| Substance, material or article  | MP | Class | UN No. |
|---|----|-------|--------|
| 2-Methyl-2-propanol   | –  | 3     | 1120   |
| 2-Methylpropanoyl chloride, <i>see</i>  | –  | 3     | 2395   |
| 2-Methyl-2-propen-1-ol, <i>see</i>  | –  | 3     | 2614   |
| METHYL PROPIONATE   | –  | 3     | 1248   |
| 2-Methylpropionic acid, <i>see</i>  | –  | 3     | 2529   |
| Methylpropyl acrylate, stabilized, <i>see</i>   | –  | 3     | 2527   |
| Methylpropylbenzenes, <i>see</i>  | P  | 3     | 2046   |
| METHYL PROPYL ETHER   | –  | 3     | 2612   |
| 2-Methylpropyl isobutyrate, <i>see</i>  | –  | 3     | 2528   |
| METHYL PROPYL KETONE  | –  | 3     | 1249   |
| Methylpyridines (2-; 3-; 4-), <i>see</i>  | –  | 3     | 2313   |
| 3-Methyl-4-(pyrrolidin-1-yl)benzenediazonium tetrafluoroborate<br>(concentration 95%), <i>see</i> | –  | 4.1   | 3234   |
| △ <i>alpha</i> -Methylstyrene, <i>see</i>   | P  | 3     | 2303   |
| Methylstyrenes, stabilized, <i>see</i>  | –  | 3     | 2618   |
| Methyl sulphate, <i>see</i>   | –  | 6.1   | 1595   |
| Methyl sulphide, <i>see</i>   | –  | 3     | 1164   |
| METHYLTETRAHYDROFURAN   | –  | 3     | 2536   |
| METHYL TRICHLOROACETATE   | –  | 6.1   | 2533   |
| METHYLTRICHLOROSILANE   | –  | 3     | 1250   |
| Methyltrithion, <i>see</i> ORGANOPHOSPHORUS PESTICIDE   | P  | –     | –      |
| <i>alpha</i> -METHYLVALERALDEHYDE   | –  | 3     | 2367   |
| 1-Methylvinyl acetate, <i>see</i>   | –  | 3     | 2403   |
| Methylvinylbenzenes, stabilized, <i>see</i>   | –  | 3     | 2618   |
| METHYL VINYL KETONE, STABILIZED   | –  | 6.1   | 1251   |
| Mevinphos, <i>see</i> ORGANOPHOSPHORUS PESTICIDE  | P  | –     | –      |
| Mexacarbate, <i>see</i> CARBAMATE PESTICIDE   | P  | –     | –      |
| M.I.B.C., <i>see</i>  | –  | 3     | 2053   |
| MINES with bursting charge  | –  | 1.1D  | 0137   |
| MINES with bursting charge  | –  | 1.1F  | 0136   |
| MINES with bursting charge  | –  | 1.2D  | 0138   |
| MINES with bursting charge  | –  | 1.2F  | 0294   |
| Mirex, <i>see</i> ORGANOCHLORINE PESTICIDE  | P  | –     | –      |
| Mischmetall, <i>see</i>   | –  | 4.1   | 1333   |
| Missiles, guided, <i>see</i> ROCKETS  | –  | –     | –      |
| Mixed acid, <i>see</i>  | –  | 8     | 1796   |
| Mixed acid, spent, <i>see</i>   | –  | 8     | 1826   |
| Mixtures of an inorganic nitrite with an ammonium salt<br>(transport prohibited)                  | –  | –     | –      |
| Mobam, <i>see</i> CARBAMATE PESTICIDE   | –  | –     | –      |
| MOLYBDENUM PENTACHLORIDE  | –  | 8     | 2508   |
| Monobromobenzene, <i>see</i>  | P  | 3     | 2514   |
| Monochloroacetic acid, molten, <i>see</i>   | –  | 6.1   | 3250   |
| Monochloroacetic acid, solid, <i>see</i>  | –  | 6.1   | 1751   |

## Index

| Substance, material or article  | MP | Class | UN No. |
|---|----|-------|--------|
| Monochloroacetic acid solution, <i>see</i>  | –  | 6.1   | 1750   |
| Monochloroacetone, stabilized, <i>see</i>   | P  | 6.1   | 1695   |
| Monochlorobenzene, <i>see</i>   | –  | 3     | 1134   |
| Monochlorobenzol, <i>see</i>  | –  | 3     | 1134   |
| Monochlorodifluoromethane, <i>see</i>   | –  | 2.2   | 1018   |
| Monochlorodifluoromethane and monochloropentafluoroethane mixture with fixed boiling point containing about 49% monochlorodifluoromethane, <i>see</i> | –  | 2.2   | 1973   |
| Monochlorodifluoromonobromomethane, <i>see</i>  | –  | 2.2   | 1974   |
| Monochloropentafluoroethane, <i>see</i>   | –  | 2.2   | 1020   |
| Monochlorotetrafluoroethane, <i>see</i>   | –  | 2.2   | 1021   |
| Monochlorotrifluoromethane, <i>see</i>  | –  | 2.2   | 1022   |
| Monocrotophos, <i>see</i> ORGANOPHOSPHORUS PESTICIDE  | P  | –     | –      |
| Monoethanolamine, <i>see</i>  | –  | 8     | 2491   |
| Monoethylamine, <i>see</i>  | –  | 2.1   | 1036   |
| Monoethylamine, aqueous solution, <i>see</i>  | –  | 3     | 2270   |
| Monomethylamine, anhydrous, <i>see</i>  | –  | 2.1   | 1061   |
| Monomethylamine, aqueous solution, <i>see</i>   | –  | 3     | 1235   |
| Monomethylaniline, <i>see</i>   | –  | 6.1   | 2294   |
| MONONITROTOLUIDINES   | –  | 6.1   | 2660   |
| Monopropylamine, <i>see</i>   | –  | 3     | 1277   |
| MORPHOLINE  | –  | 8     | 2054   |
| MOTOR FUEL ANTI-KNOCK MIXTURE   | P  | 6.1   | 1649   |
| MOTOR FUEL ANTI-KNOCK MIXTURE, FLAMMABLE  | P  | 6.1   | 3483   |
| MOTOR SPIRIT  | –  | 3     | 1203   |
| Muriatic acid, <i>see</i>   | –  | 8     | 1789   |
| Muritan, <i>see</i> CARBAMATE PESTICIDE   | –  | –     | –      |
| MUSK XYLENE   | –  | 4.1   | 2956   |
| Mysorite, <i>see</i>  | –  | 9     | 2212   |
| Nabam, <i>see</i> Note 1  | P  | –     | –      |
| Naled, <i>see</i> ORGANOPHOSPHORUS PESTICIDE  | P  | –     | –      |
| Naphtha, <i>see</i>   | –  | 3     | 1268   |
| NAPHTHALENE, CRUDE  | P  | 4.1   | 1334   |
| NAPHTHALENE, MOLTEN   | P  | 4.1   | 2304   |
| NAPHTHALENE, REFINED  | P  | 4.1   | 1334   |
| Naphtha, petroleum, <i>see</i>  | –  | 3     | 1268   |
| Naphtha, solvent, <i>see</i>  | –  | 3     | 1268   |
| <i>alpha</i> -NAPHTHYLAMINE   | –  | 6.1   | 2077   |
| <i>beta</i> -NAPHTHYLAMINE, SOLID   | –  | 6.1   | 1650   |
| <i>beta</i> -NAPHTHYLAMINE SOLUTION   | –  | 6.1   | 3411   |
| NAPHTHYLTHIOUREA  | –  | 6.1   | 1651   |
| 1-Naphthylthiourea, <i>see</i>  | –  | 6.1   | 1651   |
| <i>alpha</i> -Naphthylthiourea, <i>see</i>  | –  | 6.1   | 1651   |

| Substance, material or article  | MP | Class | UN No. |
|---|----|-------|--------|
| NAPHTHYLUREA  | –  | 6.1   | 1652   |
| NATURAL GAS, COMPRESSED with high methane content   | –  | 2.1   | 1971   |
| Natural gasoline, <i>see</i> MOTOR SPIRIT <i>or</i> GASOLINE <i>or</i> PETROL               | –  | –     | –      |
| NATURAL GAS, REFRIGERATED LIQUID with high methane content                                  | –  | 2.1   | 1972   |
| Neodymium nitrate and praseodymium nitrate mixture, <i>see</i>                              | –  | 5.1   | 1456   |
| Neohexane, <i>see</i>   | –  | 3     | 1208   |
| NEON, COMPRESSED  | –  | 2.2   | 1065   |
| NEON, REFRIGERATED LIQUID   | –  | 2.2   | 1913   |
| Neopentane, <i>see</i>  | –  | 2.1   | 2044   |
| Neothyl, <i>see</i>   | –  | 3     | 2612   |
| NICKEL CARBONYL   | P  | 6.1   | 1259   |
| NICKEL CYANIDE  | P  | 6.1   | 1653   |
| Nickel(II) cyanide, <i>see</i>  | P  | 6.1   | 1653   |
| NICKEL NITRATE  | –  | 5.1   | 2725   |
| Nickel(II) nitrate, <i>see</i>  | –  | 5.1   | 2725   |
| NICKEL NITRITE  | –  | 5.1   | 2726   |
| Nickel(II) nitrite, <i>see</i>  | –  | 5.1   | 2726   |
| Nickelous nitrate, <i>see</i>   | –  | 5.1   | 2725   |
| Nickelous nitrite, <i>see</i>   | –  | 5.1   | 2726   |
| Nickel tetracarbonyl, <i>see</i>  | P  | 6.1   | 1259   |
| NICOTINE  | –  | 6.1   | 1654   |
| NICOTINE COMPOUND, LIQUID, N.O.S.   | –  | 6.1   | 3144   |
| NICOTINE COMPOUND, SOLID, N.O.S.  | –  | 6.1   | 1655   |
| NICOTINE HYDROCHLORIDE, LIQUID  | –  | 6.1   | 1656   |
| NICOTINE HYDROCHLORIDE, SOLID   | –  | 6.1   | 3444   |
| NICOTINE HYDROCHLORIDE SOLUTION   | –  | 6.1   | 1656   |
| NICOTINE PREPARATION, LIQUID, N.O.S.  | –  | 6.1   | 3144   |
| NICOTINE PREPARATION, SOLID, N.O.S.   | –  | 6.1   | 1655   |
| NICOTINE SALICYLATE   | –  | 6.1   | 1657   |
| NICOTINE SULPHATE, SOLID  | –  | 6.1   | 3445   |
| NICOTINE SULPHATE SOLUTION  | –  | 6.1   | 1658   |
| NICOTINE TARTRATE   | –  | 6.1   | 1659   |
| NITRATES, INORGANIC, AQUEOUS SOLUTION, N.O.S.   | –  | 5.1   | 3218   |
| NITRATES, INORGANIC, N.O.S.   | –  | 5.1   | 1477   |
| NITRATING ACID MIXTURE, SPENT, with more than 50% nitric acid                               | –  | 8     | 1826   |
| NITRATING ACID MIXTURE, SPENT, with not more than 50% nitric acid                           | –  | 8     | 1826   |
| NITRATING ACID MIXTURE with more than 50% nitric acid                                       | –  | 8     | 1796   |
| NITRATING ACID MIXTURE with not more than 50% nitric acid                                   | –  | 8     | 1796   |
| NITRIC ACID other than red fuming, with at least 65% but with not more than 70% nitric acid | –  | 8     | 2031   |
| NITRIC ACID other than red fuming, with less than 65% nitric acid                           | –  | 8     | 2031   |
| NITRIC ACID other than red fuming, with more than 70% nitric acid                           | –  | 8     | 2031   |
| NITRIC ACID, RED FUMING   | –  | 8     | 2032   |



## Index

| Substance, material or article   | MP | Class | UN No. |
|--|----|-------|--------|
| NITRIC OXIDE AND DINITROGEN TETROXIDE MIXTURE  | –  | 2.3   | 1975   |
| NITRIC OXIDE AND NITROGEN DIOXIDE MIXTURE  | –  | 2.3   | 1975   |
| NITRIC OXIDE, COMPRESSED   | –  | 2.3   | 1660   |
| NITRILES, FLAMMABLE, TOXIC, N.O.S.   | –  | 3     | 3273   |
| NITRILES, TOXIC, FLAMMABLE, N.O.S.   | –  | 6.1   | 3275   |
| NITRILES, LIQUID TOXIC, N.O.S.   | –  | 6.1   | 3276   |
| NITRILES, SOLID, TOXIC, N.O.S.   | –  | 6.1   | 3439   |
| NITRITES, INORGANIC, AQUEOUS SOLUTION, N.O.S.  | –  | 5.1   | 3219   |
| Nitrites, inorganic, mixtures with ammonium compounds<br>(transport prohibited)  | –  | –     | –      |
| NITRITES, INORGANIC, N.O.S.  | –  | 5.1   | 2627   |
| NITROANILINES ( <i>o</i> -, <i>m</i> -, <i>p</i> -)  | –  | 6.1   | 1661   |
| NITROANISOLES, LIQUID  | –  | 6.1   | 2730   |
| NITROANISOLES, SOLID   | –  | 6.1   | 3458   |
| NITROBENZENE   | –  | 6.1   | 1662   |
| Nitrobenzene bromides, liquid, see   | –  | 6.1   | 2732   |
| Nitrobenzene bromides, solid, see  | –  | 6.1   | 3459   |
| NITROBENZENESULPHONIC ACID   | –  | 8     | 2305   |
| Nitrobenzol, see   | –  | 6.1   | 1662   |
| 5-NITROBENZOTRIAZOL  | –  | 1.1D  | 0385   |
| NITROBENZOTRIFLUORIDES, LIQUID   | P  | 6.1   | 2306   |
| NITROBENZOTRIFLUORIDES, SOLID  | P  | 6.1   | 3431   |
| NITROBROMOBENZENES, LIQUID   | –  | 6.1   | 2732   |
| NITROBROMOBENZENES, SOLID  | –  | 6.1   | 3459   |
| Nitrocarbonitrates, see EXPLOSIVE, BLASTING, TYPE B  | –  | –     | –      |
| NITROCELLULOSE, dry or wetted with less than 25% water (or<br>alcohol), by mass  | –  | 1.1D  | 0340   |
| NITROCELLULOSE MEMBRANE FILTERS with not more than 12.6%<br>nitrogen, by dry mass  | –  | 4.1   | 3270   |
| NITROCELLULOSE, PLASTICIZED with not less than 18% plasticizing<br>substance, by mass                                      | –  | 1.3C  | 0343   |
| NITROCELLULOSE SOLUTION, FLAMMABLE with not more than<br>12.6% nitrogen, by dry mass, and not more than 55% nitrocellulose | –  | 3     | 2059   |
| NITROCELLULOSE, unmodified or plasticized with less than 18%<br>plasticizing substance, by mass                            | –  | 1.1D  | 0341   |
| NITROCELLULOSE, WETTED with not less than 25% alcohol, by mass   | –  | 1.3C  | 0342   |
| NITROCELLULOSE WITH ALCOHOL (not less than 25% alcohol,<br>by mass, and not more than 12.6% nitrogen, by dry mass)         | –  | 4.1   | 2556   |
| NITROCELLULOSE with not more than 12.6% nitrogen, by dry mass,<br>MIXTURE WITHOUT PLASTICIZER, WITHOUT PIGMENT             | –  | 4.1   | 2557   |
| NITROCELLULOSE with not more than 12.6% nitrogen, by dry mass,<br>MIXTURE WITHOUT PLASTICIZER, WITH PIGMENT                | –  | 4.1   | 2557   |
| NITROCELLULOSE with not more than 12.6% nitrogen, by dry mass,<br>MIXTURE WITH PLASTICIZER, WITHOUT PIGMENT                | –  | 4.1   | 2557   |
| NITROCELLULOSE with not more than 12.6% nitrogen, by dry mass,<br>MIXTURE WITH PLASTICIZER, WITH PIGMENT                   | –  | 4.1   | 2557   |

| Substance, material or article  | MP | Class | UN No. |
|---|----|-------|--------|
| NITROCELLULOSE WITH WATER (not less than 25% water, by mass)  | –  | 4.1   | 2555   |
| Nitrochlorobenzenes, <i>see</i>   | –  | 6.1   | 1578   |
| 3-NITRO-4-CHLOROBENZOTRIFLUORIDE  | P  | 6.1   | 2307   |
| Nitrocotton solution, <i>see</i>  | –  | 3     | 2059   |
| Nitrocotton with alcohol, <i>see</i>  | –  | 4.1   | 2556   |
| Nitrocotton with plasticizing substance, <i>see</i>   | –  | 4.1   | 2557   |
| Nitrocotton with water, <i>see</i>  | –  | 4.1   | 2555   |
| NITROCRESOLS, LIQUID  | –  | 6.1   | 3434   |
| NITROCRESOLS, SOLID   | –  | 6.1   | 2446   |
| NITROETHANE   | –  | 3     | 2842   |
| NITROGEN, COMPRESSED  | –  | 2.2   | 1066   |
| NITROGEN DIOXIDE  | –  | 2.3   | 1067   |
| Nitrogen dioxide and nitric oxide mixtures, <i>see</i>  | –  | 2.3   | 1975   |
| Nitrogen peroxide, <i>see</i>   | –  | 2.3   | 1067   |
| NITROGEN, REFRIGERATED LIQUID   | –  | 2.2   | 1977   |
| Nitrogen sesquioxide, <i>see</i>  | –  | 2.3   | 2421   |
| NITROGEN TRIFLUORIDE  | –  | 2.2   | 2451   |
| NITROGEN TRIOXIDE   | –  | 2.3   | 2421   |
| NITROGLYCERIN, DESENSITIZED with not less than 40% non-volatile water-insoluble phlegmatizer, by mass             | –  | 1.1D  | 0143   |
| NITROGLYCERIN MIXTURE, DESENSITIZED, LIQUID, FLAMMABLE, N.O.S. with not more than 30% nitroglycerin, by mass      | –  | 3     | 3343   |
| NITROGLYCERIN MIXTURE, DESENSITIZED, LIQUID, N.O.S. with not more than 30% nitroglycerin, by mass                 | –  | 3     | 3357   |
| NITROGLYCERIN MIXTURE, DESENSITIZED, SOLID, N.O.S. with more than 2% but not more than 10% nitroglycerin, by mass | –  | 4.1   | 3319   |
| NITROGLYCERIN SOLUTION IN ALCOHOL with more than 1% but not more than 5% nitroglycerin                            | –  | 3     | 3064   |
| NITROGLYCERIN SOLUTION IN ALCOHOL with more than 1% but not more than 10% nitroglycerin                           | –  | 1.1D  | 0144   |
| NITROGLYCERIN SOLUTION IN ALCOHOL with not more than 1% nitroglycerin   | –  | 3     | 1204   |
| NITROGUANIDINE, dry or wetted with less than 20% water, by mass   | –  | 1.1D  | 0282   |
| NITROGUANIDINE, WETTED with not less than 20% water, by mass  | –  | 4.1   | 1336   |
| NITROHYDROCHLORIC ACID  | –  | 8     | 1798   |
| NITROMANNITE, WETTED with not less than 40% water, or mixture of alcohol and water, by mass                       | –  | 1.1D  | 0133   |
| NITROMETHANE  | –  | 3     | 1261   |
| Nitromuriatic acid, <i>see</i>  | –  | 8     | 1798   |
| NITRONAPHTHALENE  | –  | 4.1   | 2538   |
| NITROPHENOLS ( <i>o</i> -, <i>m</i> -, <i>p</i> -)  | –  | 6.1   | 1663   |
| 4-NITROPHENYLHYDRAZINE with not less than 30% water, by mass  | –  | 4.1   | 3376   |
| NITROPROPANES   | –  | 3     | 2608   |
| <i>p</i> -NITROSODIMETHYLANILINE  | –  | 4.2   | 1369   |
| 4-Nitrosophenol (concentration 100%), <i>see</i>  | –  | 4.1   | 3236   |
| NITROSTARCH, dry or wetted, with less than 20% water, by mass   | –  | 1.1D  | 0146   |
| NITROSTARCH, WETTED with not less than 20% water, by mass   | –  | 4.1   | 1337   |

## Index

| Substance, material or article                            | MP | Class | UN No. |
|---|----|-------|--------|
| NITROSYL CHLORIDE   | –  | 2.3   | 1069   |
| NITROSYLSULPHURIC ACID, LIQUID                            | –  | 8     | 2308   |
| NITROSYLSULPHURIC ACID, SOLID                             | –  | 8     | 3456   |
| NITROTOLUENES, LIQUID                                     | –  | 6.1   | 1664   |
| NITROTOLUENES, SOLID                                      | –  | 6.1   | 3446   |
| NITROTOLUIDINES (MONO)                                    | –  | 6.1   | 2660   |
| NITROTRIAZOLONE   | –  | 1.1D  | 0490   |
| Nitrotrichloromethane, <i>see</i>                         | –  | 6.1   | 1580   |
| NITRO UREA  | –  | 1.1D  | 0147   |
| Nitrous ether solution, <i>see</i>                        | –  | 3     | 1194   |
| NITROUS OXIDE   | –  | 2.2   | 1070   |
| NITROUS OXIDE, REFRIGERATED LIQUID                        | –  | 2.2   | 2201   |
| NITROXYLENES, LIQUID                                      | –  | 6.1   | 1665   |
| NITROXYLENES, SOLID                                       | –  | 6.1   | 3447   |
| Non-activated carbon, <i>see</i>                          | –  | 4.2   | 1361   |
| Non-activated charcoal, <i>see</i>                        | –  | 4.2   | 1361   |
| NONANES   | P  | 3     | 1920   |
| Nonylphenol, <i>see</i>                                   | P  | 8     | 3145   |
| NONYLTRICHLOROSILANE                                      | –  | 8     | 1799   |
| Norbormide, <i>see</i> PESTICIDE, N.O.S.                  | –  | –     | –      |
| 2,5-NORBORNADIENE, STABILIZED                             | –  | 3     | 2251   |
| NTO   | –  | 1.1D  | 0490   |
|   |    |       |        |
| OCTADECYLTRICHLOROSILANE                                  | –  | 8     | 1800   |
| OCTADIENE   | –  | 3     | 2309   |
| OCTAFLUOROBUT-2-ENE                                       | –  | 2.2   | 2422   |
| Octafluoro-2-butene, <i>see</i>                           | –  | 2.2   | 2422   |
| OCTAFLUOROCYCLOBUTANE                                     | –  | 2.2   | 1976   |
| OCTAFLUOROPROPANE   | –  | 2.2   | 2424   |
| Octaldehyde, <i>see</i>                                   | –  | 3     | 1191   |
| OCTANES   | P  | 3     | 1262   |
| 3-Octanone, <i>see</i>                                    | –  | 3     | 2271   |
| OCTOGEN, DESENSITIZED                                     | –  | 1.1D  | 0484   |
| OCTOGEN, WETTED with not less than 15% water, by mass     | –  | 1.1D  | 0226   |
| OCTOL, dry or wetted with less than 15% water, by mass    | –  | 1.1D  | 0266   |
| OCTOLITE, dry or wetted with less than 15% water, by mass | –  | 1.1D  | 0266   |
| OCTONAL   | –  | 1.1D  | 0496   |
| OCTYL ALDEHYDES   | –  | 3     | 1191   |
| <i>tert</i> -Octyl mercaptan, <i>see</i>                  | –  | 6.1   | 3023   |
| OCTYLTRICHLOROSILANE                                      | –  | 8     | 1801   |
| Oenanthal, <i>see</i>                                     | –  | 3     | 3056   |
| Oil cake, <i>see</i>                                      | –  | 4.2   | 1386   |
| OIL GAS, COMPRESSED                                       | –  | 2.3   | 1071   |

| Substance, material or article  | MP | Class | UN No. |
|---|----|-------|--------|
| Oleum, see  | –  | 8     | 1831   |
| Oleylamine, see Note 1  | P  | –     | –      |
| Omethoate, see ORGANOPHOSPHORUS PESTICIDE   | –  | –     | –      |
| Organic peroxide, liquid, sample, see   | –  | 5.2   | 3103   |
| Organic peroxide, liquid, sample, temperature controlled, see                     | –  | 5.2   | 3113   |
| Organic peroxide, solid, sample, see  | –  | 5.2   | 3104   |
| Organic peroxide, solid, sample, temperature controlled, see                      | –  | 5.2   | 3114   |
| ORGANIC PEROXIDE TYPE B, LIQUID   | –  | 5.2   | 3101   |
| ORGANIC PEROXIDE TYPE B, LIQUID, TEMPERATURE CONTROLLED                           | –  | 5.2   | 3111   |
| ORGANIC PEROXIDE TYPE B, SOLID  | –  | 5.2   | 3102   |
| ORGANIC PEROXIDE TYPE B, SOLID, TEMPERATURE CONTROLLED                            | –  | 5.2   | 3112   |
| ORGANIC PEROXIDE TYPE C, LIQUID   | –  | 5.2   | 3103   |
| ORGANIC PEROXIDE TYPE C, LIQUID, TEMPERATURE CONTROLLED                           | –  | 5.2   | 3113   |
| ORGANIC PEROXIDE TYPE C, SOLID  | –  | 5.2   | 3104   |
| ORGANIC PEROXIDE TYPE C, SOLID, TEMPERATURE CONTROLLED                            | –  | 5.2   | 3114   |
| ORGANIC PEROXIDE TYPE D, LIQUID   | –  | 5.2   | 3105   |
| ORGANIC PEROXIDE TYPE D, LIQUID, TEMPERATURE CONTROLLED                           | –  | 5.2   | 3115   |
| ORGANIC PEROXIDE TYPE D, SOLID  | –  | 5.2   | 3106   |
| ORGANIC PEROXIDE TYPE D, SOLID, TEMPERATURE CONTROLLED                            | –  | 5.2   | 3116   |
| ORGANIC PEROXIDE TYPE E, LIQUID   | –  | 5.2   | 3107   |
| ORGANIC PEROXIDE TYPE E, LIQUID, TEMPERATURE CONTROLLED                           | –  | 5.2   | 3117   |
| ORGANIC PEROXIDE TYPE E, SOLID  | –  | 5.2   | 3108   |
| ORGANIC PEROXIDE TYPE E, SOLID, TEMPERATURE CONTROLLED                            | –  | 5.2   | 3118   |
| ORGANIC PEROXIDE TYPE F, LIQUID   | –  | 5.2   | 3109   |
| ORGANIC PEROXIDE TYPE F, LIQUID, TEMPERATURE CONTROLLED                           | –  | 5.2   | 3119   |
| ORGANIC PEROXIDE TYPE F, SOLID  | –  | 5.2   | 3110   |
| ORGANIC PEROXIDE TYPE F, SOLID, TEMPERATURE CONTROLLED                            | –  | 5.2   | 3120   |
| ORGANIC PIGMENTS, SELF-HEATING  | –  | 4.2   | 3313   |
| ORGANOARSENIC COMPOUND, LIQUID, N.O.S.  | –  | 6.1   | 3280   |
| ORGANOARSENIC COMPOUND, SOLID, N.O.S.   | –  | 6.1   | 3465   |
| ORGANOCHLORINE PESTICIDE, LIQUID, FLAMMABLE, TOXIC, flashpoint less than 23°C     | –  | 3     | 2762   |
| ORGANOCHLORINE PESTICIDE, LIQUID, TOXIC   | –  | 6.1   | 2996   |
| ORGANOCHLORINE PESTICIDE, LIQUID, TOXIC, FLAMMABLE, flashpoint not less than 23°C | –  | 6.1   | 2995   |
| ORGANOCHLORINE PESTICIDE, SOLID, TOXIC  | –  | 6.1   | 2761   |
| Organometallic compound dispersion, water-reactive, flammable, see                | –  | 4.3   | 3399   |
| Organometallic compound solid, water-reactive, flammable, see                     | –  | 4.3   | 3396   |
| Organometallic compound solution, water-reactive, flammable, see                  | –  | 4.3   | 3399   |
| ORGANOMETALLIC COMPOUND, LIQUID, TOXIC, N.O.S.                                    | –  | 6.1   | 3282   |
| ORGANOMETALLIC COMPOUND, SOLID, TOXIC, N.O.S.                                     | –  | 6.1   | 3467   |

## Index

| Substance, material or article   | MP | Class | UN No. |
|--|----|-------|--------|
| ORGANOMETALLIC SUBSTANCE, LIQUID, PYROPHORIC   | –  | 4.2   | 3392   |
| ORGANOMETALLIC SUBSTANCE, LIQUID, PYROPHORIC,<br>WATER-REACTIVE                        | –  | 4.2   | 3394   |
| ORGANOMETALLIC SUBSTANCE, LIQUID, WATER-REACTIVE                                       | –  | 4.3   | 3398   |
| ORGANOMETALLIC SUBSTANCE, LIQUID, WATER-REACTIVE,<br>FLAMMABLE                         | –  | 4.3   | 3399   |
| ORGANOMETALLIC SUBSTANCE, SOLID, PYROPHORIC  | –  | 4.2   | 3391   |
| ORGANOMETALLIC SUBSTANCE, SOLID, PYROPHORIC,<br>WATER-REACTIVE                         | –  | 4.2   | 3393   |
| ORGANOMETALLIC SUBSTANCE, SOLID, SELF-HEATING  | –  | 4.2   | 3400   |
| ORGANOMETALLIC SUBSTANCE, SOLID, WATER-REACTIVE  | –  | 4.3   | 3395   |
| ORGANOMETALLIC SUBSTANCE, SOLID, WATER-REACTIVE,<br>FLAMMABLE                          | –  | 4.3   | 3396   |
| ORGANOMETALLIC SUBSTANCE, SOLID, WATER-REACTIVE,<br>SELF-HEATING                       | –  | 4.3   | 3397   |
| ORGANOPHOSPHORUS COMPOUND, TOXIC, FLAMMABLE, N.O.S.                                    | –  | 6.1   | 3279   |
| ORGANOPHOSPHORUS COMPOUND, LIQUID, TOXIC, N.O.S.                                       | –  | 6.1   | 3278   |
| ORGANOPHOSPHORUS COMPOUND, SOLID, TOXIC, N.O.S.  | –  | 6.1   | 3464   |
| ORGANOPHOSPHORUS PESTICIDE, LIQUID, FLAMMABLE, TOXIC,<br>flashpoint less than 23°C     | –  | 3     | 2784   |
| ORGANOPHOSPHORUS PESTICIDE, LIQUID, TOXIC  | –  | 6.1   | 3018   |
| ORGANOPHOSPHORUS PESTICIDE, LIQUID, TOXIC, FLAMMABLE,<br>flashpoint not less than 23°C | –  | 6.1   | 3017   |
| ORGANOPHOSPHORUS PESTICIDE, SOLID, TOXIC   | –  | 6.1   | 2783   |
| ORGANOTIN COMPOUND, LIQUID, N.O.S.   | P  | 6.1   | 2788   |
| ORGANOTIN COMPOUND, SOLID, N.O.S.  | P  | 6.1   | 3146   |
| Organotin compounds (pesticides), see ORGANOTIN PESTICIDE                              | P  | –     | –      |
| ORGANOTIN PESTICIDE, LIQUID, FLAMMABLE, TOXIC,<br>flashpoint less than 23°C            | P  | 3     | 2787   |
| ORGANOTIN PESTICIDE, LIQUID, TOXIC   | P  | 6.1   | 3020   |
| ORGANOTIN PESTICIDE, LIQUID, TOXIC, FLAMMABLE,<br>flashpoint not less than 23°C        | P  | 6.1   | 3019   |
| ORGANOTIN PESTICIDE, SOLID, TOXIC  | P  | 6.1   | 2786   |
| Orthoarsenic acid, see   | –  | 6.1   | 1553   |
| Orthophosphoric acid, liquid, see  | –  | 8     | 1805   |
| Orthophosphoric acid, solid, see   | –  | 8     | 3453   |
| OSMIUM TETROXIDE   | P  | 6.1   | 2471   |
| Oxamyl, see CARBAMATE PESTICIDE  | P  | –     | –      |
| OXIDIZING LIQUID, CORROSIVE, N.O.S.  | –  | 5.1   | 3098   |
| OXIDIZING LIQUID, N.O.S.   | –  | 5.1   | 3139   |
| OXIDIZING LIQUID, TOXIC, N.O.S.  | –  | 5.1   | 3099   |
| OXIDIZING SOLID, CORROSIVE, N.O.S.   | –  | 5.1   | 3085   |
| OXIDIZING SOLID, FLAMMABLE, N.O.S.   | –  | 5.1   | 3137   |
| OXIDIZING SOLID, N.O.S.  | –  | 5.1   | 1479   |
| OXIDIZING SOLID, SELF-HEATING, N.O.S.  | –  | 5.1   | 3100   |
| OXIDIZING SOLID, TOXIC, N.O.S.   | –  | 5.1   | 3087   |

| Substance, material or article   | MP | Class | UN No. |
|--|----|-------|--------|
| OXIDIZING SOLID, WATER-REACTIVE, N.O.S.  | –  | 5.1   | 3121   |
| Oxirane, <i>see</i>  | –  | 2.3   | 1040   |
| Oxirane with nitrogen up to a total pressure of 1 MPa (10 bar) at 50°C   | –  | 2.3   | 1040   |
| Oxydemeton-methyl, <i>see</i> ORGANOPHOSPHORUS PESTICIDE   | –  | –     | –      |
| Oxydisulfoton, <i>see</i> ORGANOPHOSPHORUS PESTICIDE   | P  | –     | –      |
| OXYGEN, COMPRESSED   | –  | 2.2   | 1072   |
| OXYGEN DIFLUORIDE, COMPRESSED  | –  | 2.3   | 2190   |
| Oxygen fluoride, compressed, <i>see</i>  | –  | 2.3   | 2190   |
| OXYGEN GENERATOR, CHEMICAL   | –  | 5.1   | 3356   |
| OXYGEN, REFRIGERATED LIQUID  | –  | 2.2   | 1073   |
| 1-Oxy-4-nitrobenzene, <i>see</i>   | –  | 6.1   | 1662   |
| PACKAGINGS, DISCARDED, EMPTY, UNCLEANED  | –  | 9     | 3509   |
| PAINT (including paint, lacquer, enamel, stain, shellac, varnish, polish, liquid filler and liquid lacquer base)                       | –  | 3     | 1263   |
| PAINT (including paint, lacquer, enamel, stain, shellac, varnish, polish, liquid filler and liquid lacquer base)                       | –  | 8     | 3066   |
| PAINT, CORROSIVE, FLAMMABLE (including paint, lacquer, enamel, stain, shellac, varnish, polish, liquid filler and liquid lacquer base) | –  | 8     | 3470   |
| PAINT, FLAMMABLE, CORROSIVE (including paint, lacquer, enamel, stain, shellac, varnish, polish, liquid filler and liquid lacquer base) | –  | 3     | 3469   |
| PAINT RELATED MATERIAL (including paint thinning or reducing compound)   | –  | 3     | 1263   |
| PAINT RELATED MATERIAL (including paint thinning or reducing compound)   | –  | 8     | 3066   |
| PAINT RELATED MATERIAL, CORROSIVE, FLAMMABLE (including paint thinning or reducing compound)   | –  | 8     | 3470   |
| PAINT RELATED MATERIAL, FLAMMABLE, CORROSIVE (including paint thinning or reducing compound)   | –  | 3     | 3469   |
| PAPER, UNSATURATED OIL TREATED, incompletely dried (including carbon paper)  | –  | 4.2   | 1379   |
| Para-acetaldehyde, <i>see</i>  | –  | 3     | 1264   |
| PARAFORMALDEHYDE   | –  | 4.1   | 2213   |
| PARALDEHYDE  | –  | 3     | 1264   |
| Paraoxon, <i>see</i> ORGANOPHOSPHORUS PESTICIDE  | P  | –     | –      |
| Paraquat, <i>see</i> BIPYRIDILUM PESTICIDE   | –  | –     | –      |
| Parathion, <i>see</i> ORGANOPHOSPHORUS PESTICIDE   | P  | –     | –      |
| Parathion-methyl, <i>see</i> ORGANOPHOSPHORUS PESTICIDE  | P  | –     | –      |
| PCBs, liquid, <i>see</i>   | P  | 9     | 2315   |
| PCBs, solid, <i>see</i>  | P  | 9     | 3432   |
| PENTABORANE  | –  | 4.2   | 1380   |
| PENTACHLOROETHANE  | P  | 6.1   | 1669   |
| PENTACHLOROPHENOL  | P  | 6.1   | 3155   |
| Pentachlorophenol, <i>see</i> ORGANOCHLORINE PESTICIDE   | P  | –     | –      |
| PENTAERYTHRIT TETRANITRATE, DESENSITIZED with not less than 15% phlegmatizer, by mass  | –  | 1.1D  | 0150   |



## Index

| Substance, material or article   | MP | Class | UN No. |
|--|----|-------|--------|
| PENTAERYTHRITOL TETRANITRATE MIXTURE, DESENSITIZED, SOLID, N.O.S. with more than 10% but not more than 20% PETN, by mass | –  | 4.1   | 3344   |
| PENTAERYTHRITOL TETRANITRATE, WETTED with not less than 25% water, by mass   | –  | 1.1D  | 0150   |
| PENTAERYTHRITOL TETRANITRATE with not less than 7% wax, by mass  | –  | 1.1D  | 0411   |
| PENTAERYTHRITOL TETRANITRATE, DESENSITIZED with not less than 15% phlegmatizer, by mass                                  | –  | 1.1D  | 0150   |
| PENTAERYTHRITOL TETRANITRATE MIXTURE, DESENSITIZED, SOLID, N.O.S. with more than 10% but not more than 20% PETN, by mass | –  | 4.1   | 3344   |
| PENTAERYTHRITOL TETRANITRATE, WETTED with not less than 25% water, by mass   | –  | 1.1D  | 0150   |
| PENTAERYTHRITOL TETRANITRATE with not less than 7% wax, by mass  | –  | 1.1D  | 0411   |
| PENTAFLUOROETHANE  | –  | 2.2   | 3220   |
| Pentafluoroethoxytrifluoroethylene, <i>see</i>   | –  | 2.1   | 3154   |
| Pentafluoroethyl trifluorovinyl ether, <i>see</i>  | –  | 2.1   | 3154   |
| Pentalin, <i>see</i>   | P  | 6.1   | 1669   |
| Pentamethylene, <i>see</i>   | –  | 3     | 1146   |
| PENTAMETHYLHEPTANE   | –  | 3     | 2286   |
| 3,3,5,7,7-Pentamethyl-1,2,4-trioxepane (concentration ≤ 100%)  | –  | 5.2   | 3107   |
| Pentanals, <i>see</i>  | –  | 3     | 2058   |
| Pentane, <i>see</i>  | –  | 3     | 1265   |
| PENTANE-2,4-DIONE  | –  | 3     | 2310   |
| 2,4-Pentanedione, <i>see</i>   | –  | 3     | 2310   |
| PENTANES, liquid   | –  | 3     | 1265   |
| Pentanethiols, <i>see</i>  | –  | 3     | 1111   |
| PENTANOLS  | –  | 3     | 1105   |
| 2-Pentanone, <i>see</i>  | –  | 3     | 1249   |
| 3-Pentanone, <i>see</i>  | –  | 3     | 1156   |
| 1-PENTENE  | –  | 3     | 1108   |
| 1-PENTOL   | –  | 8     | 2705   |
| PENTOLITE, dry or wetted with less than 15% water, by mass   | –  | 1.1D  | 0151   |
| Pentylamines, <i>see</i>   | –  | 3     | 1106   |
| <i>n</i> -Pentylbenzene, <i>see</i> Note 1   | P  | –     | –      |
| Pentyl butanoates, <i>see</i>  | –  | 3     | 2620   |
| Pentyl butyrates, <i>see</i>   | –  | 3     | 2620   |
| Pentyl formates, <i>see</i>  | –  | 3     | 1109   |
| Pentyl nitrates, <i>see</i>  | –  | 3     | 1112   |
| Pentyl nitrite, <i>see</i>   | –  | 3     | 1113   |
| PERCHLORATES, INORGANIC, AQUEOUS SOLUTION, N.O.S.  | –  | 5.1   | 3211   |
| PERCHLORATES, INORGANIC, N.O.S.  | –  | 5.1   | 1481   |
| PERCHLORIC ACID with more than 50% but not more than 72% acid, by mass   | –  | 5.1   | 1873   |

| Substance, material or article  | MP | Class | UN No. |
|---|----|-------|--------|
| PERCHLORIC ACID, with more than 72% acid by mass<br>(transport prohibited)                          | –  | –     | –      |
| PERCHLORIC ACID with not more than 50% acid, by mass  | –  | 8     | 1802   |
| Perchlorobenzene, see   | –  | 6.1   | 2729   |
| Perchlorocyclopentadiene, see   | –  | 6.1   | 2646   |
| Perchloroethylene, see  | P  | 6.1   | 1897   |
| PERCHLOROMETHYL MERCAPTAN   | P  | 6.1   | 1670   |
| PERCHLORYL FLUORIDE   | –  | 2.3   | 3083   |
| Perfluoroacetyl chloride, see   | –  | 2.3   | 3057   |
| Perfluoro-2-butene, see   | –  | 2.2   | 2422   |
| PERFLUORO(ETHYL VINYL ETHER)  | –  | 2.1   | 3154   |
| PERFLUORO(METHYL VINYL ETHER)   | –  | 2.1   | 3153   |
| Perfluoropropane, see   | –  | 2.2   | 2424   |
| PERFUMERY PRODUCTS with flammable liquid  | –  | 3     | 1266   |
| PERMANGANATES, INORGANIC, AQUEOUS SOLUTION, N.O.S.  | –  | 5.1   | 3214   |
| PERMANGANATES, INORGANIC, N.O.S.  | –  | 5.1   | 1482   |
| PEROXIDES, INORGANIC, N.O.S.  | –  | 5.1   | 1483   |
| Peroxyacetic acid and hydrogen peroxide mixture, see  | –  | 5.1   | 3149   |
| Peroxyacetic acid, Type D (concentration ≤ 43%), stabilized, see                                    | –  | 5.2   | 3105   |
| Peroxyacetic acid, Type E (concentration ≤ 43%), stabilized, see                                    | –  | 5.2   | 3107   |
| Peroxyacetic acid, Type F (concentration ≤ 43%), stabilized, see                                    | –  | 5.2   | 3109   |
| Peroxylauric acid (concentration ≤ 100%), see   | –  | 5.2   | 3118   |
| PERSULPHATES, INORGANIC, AQUEOUS SOLUTION, N.O.S.   | –  | 5.1   | 3216   |
| PERSULPHATES, INORGANIC, N.O.S.   | –  | 5.1   | 3215   |
| PESTICIDE, LIQUID, FLAMMABLE, TOXIC, N.O.S. flashpoint less<br>than 23°C                            | –  | 3     | 3021   |
| PESTICIDE, LIQUID, TOXIC, FLAMMABLE, N.O.S. flashpoint not less<br>than 23°C                        | –  | 6.1   | 2903   |
| PESTICIDE, LIQUID, TOXIC, N.O.S.  | –  | 6.1   | 2902   |
| PESTICIDE, SOLID, TOXIC, N.O.S.   | –  | 6.1   | 2588   |
| PETN, DESENSITIZED with not less than 15% phlegmatizer, by mass                                     | –  | 1.1D  | 0150   |
| PETN MIXTURE, DESENSITIZED, SOLID, N.O.S. with more than 10%<br>but not more than 20% PETN, by mass | –  | 4.1   | 3344   |
| PETN/TNT, see   | –  | 1.1D  | 0151   |
| PETN, WETTED with not less than 25% water, by mass  | –  | 1.1D  | 0150   |
| PETN with not less than 7% wax, by mass   | –  | 1.1D  | 0411   |
| PETROL  | –  | 3     | 1203   |
| PETROLEUM CRUDE OIL   | –  | 3     | 1267   |
| PETROLEUM DISTILLATES, N.O.S.   | –  | 3     | 1268   |
| Petroleum ether, see  | –  | 3     | 1268   |
| PETROLEUM GASES, LIQUEFIED  | –  | 2.1   | 1075   |
| Petroleum naphtha, see  | –  | 3     | 1268   |
| Petroleum oil, see  | –  | 3     | 1268   |
| PETROLEUM PRODUCTS, N.O.S.  | –  | 3     | 1268   |

## Index

| Substance, material or article   | MP | Class | UN No. |
|--|----|-------|--------|
| Petroleum raffinate, see   | –  | 3     | 1268   |
| PETROLEUM SOUR CRUDE OIL, FLAMMABLE, TOXIC   | –  | 3     | 3494   |
| Petroleum spirit, see PETROLEUM DISTILLATES, N.O.S. or<br>PETROLEUM PRODUCTS, N.O.S.               | –  | –     | –      |
| PHENACYL BROMIDE   | –  | 6.1   | 2645   |
| Phenarsazine chloride, see   | P  | 6.1   | 1698   |
| PHENETIDINES   | –  | 6.1   | 2311   |
| Phenkapton, see ORGANOPHOSPHORUS PESTICIDE   | –  | –     | –      |
| PHENOLATES, LIQUID   | –  | 8     | 2904   |
| PHENOLATES, SOLID  | –  | 8     | 2905   |
| PHENOL, MOLTEN   | –  | 6.1   | 2312   |
| PHENOL, SOLID  | –  | 6.1   | 1671   |
| PHENOL SOLUTION  | –  | 6.1   | 2821   |
| PHENOLSULPHONIC ACID, LIQUID   | –  | 8     | 1803   |
| <i>d</i> -Phenothrin, see Note 1   | P  | –     | –      |
| PHENOXYACETIC ACID DERIVATIVE PESTICIDE, LIQUID,<br>FLAMMABLE, TOXIC flashpoint less than 23°C     | –  | 3     | 3346   |
| PHENOXYACETIC ACID DERIVATIVE PESTICIDE, LIQUID, TOXIC   | –  | 6.1   | 3348   |
| PHENOXYACETIC ACID DERIVATIVE PESTICIDE, LIQUID, TOXIC,<br>FLAMMABLE flashpoint not less than 23°C | –  | 6.1   | 3347   |
| PHENOXYACETIC ACID DERIVATIVE PESTICIDE, SOLID, TOXIC  | –  | 6.1   | 3345   |
| Phenthoate, see ORGANOPHOSPHORUS PESTICIDE   | P  | –     | –      |
| PHENYLACETONITRILE, LIQUID   | –  | 6.1   | 2470   |
| PHENYLACETYL CHLORIDE  | –  | 8     | 2577   |
| Phenylamine, see   | P  | 6.1   | 1547   |
| Phenyl bromide, see  | P  | 3     | 2514   |
| 1-Phenylbutane, see  | P  | 3     | 2709   |
| 2-Phenylbutane, see  | P  | 3     | 2709   |
| Phenyl carbimide, see  | –  | 6.1   | 2487   |
| PHENYLCARBYLAMINE CHLORIDE   | –  | 6.1   | 1672   |
| Phenylchloroform, see  | –  | 8     | 2226   |
| PHENYL CHLOROFORMATE   | –  | 6.1   | 2746   |
| Phenyl chloromethyl ketone, liquid or solid, see   | –  | 6.1   | 1697   |
| Phenyl cyanide, see  | –  | 6.1   | 2224   |
| Phenylcyclohexane, see   | P  | 9     | 3082   |
| Phenyldichlorophosphine, see   | –  | 8     | 2798   |
| Phenyldichlorophosphine sulphide, see  | –  | 8     | 2799   |
| PHENYLENEDIAMINES ( <i>o</i> -, <i>m</i> -, <i>p</i> -)  | –  | 6.1   | 1673   |
| Phenylethane, see  | –  | 3     | 1175   |
| Phenylethylene, stabilized, see  | –  | 3     | 2055   |
| 1-Phenylethyl hydroperoxide (concentration ≤ 38%, with<br>diluent Type B), see                     | –  | 5.2   | 3109   |
| Phenyl fluoride, see   | –  | 3     | 2387   |
| PHENYLHYDRAZINE  | –  | 6.1   | 2572   |

| Substance, material or article   | MP | Class | UN No. |
|--|----|-------|--------|
| Phenyliminophosgene, <i>see</i>  | –  | 6.1   | 1672   |
| PHENYL ISOCYANATE  | –  | 6.1   | 2487   |
| Phenyl isocyanodichloride, <i>see</i>  | –  | 6.1   | 1672   |
| PHENYL MERCAPTAN   | –  | 6.1   | 2337   |
| PHENYLMERCURIC ACETATE   | P  | 6.1   | 1674   |
| PHENYLMERCURIC COMPOUND, N.O.S.  | P  | 6.1   | 2026   |
| PHENYLMERCURIC HYDROXIDE   | P  | 6.1   | 1894   |
| PHENYLMERCURIC NITRATE   | P  | 6.1   | 1895   |
| Phenyl methyl carbinol, solid or liquid, <i>see</i>  | –  | 6.1   | 2937   |
| Phenyl methyl ether, <i>see</i>  | –  | 3     | 2222   |
| PHENYLPHOSPHORUS DICHLORIDE  | –  | 8     | 2798   |
| PHENYLPHOSPHORUS THIODICHLORIDE  | –  | 8     | 2799   |
| △ 2-Phenylpropene, <i>see</i>  | P  | 3     | 2303   |
| PHENYLTRICHLOROSILANE  | –  | 8     | 1804   |
| Phenyltrifluoromethane, <i>see</i>   | –  | 3     | 2338   |
| Phorate, <i>see</i> ORGANOPHOSPHORUS PESTICIDE   | P  | –     | –      |
| Phosalone, <i>see</i> ORGANOPHOSPHORUS PESTICIDE   | P  | –     | –      |
| Phosfolan, <i>see</i> ORGANOPHOSPHORUS PESTICIDE   | –  | –     | –      |
| PHOSGENE   | –  | 2.3   | 1076   |
| Phosmet, <i>see</i> ORGANOPHOSPHORUS PESTICIDE   | P  | –     | –      |
| 9-PHOSPHABICYCLONANES  | –  | 4.2   | 2940   |
| Phosphamidon, <i>see</i> ORGANOPHOSPHORUS PESTICIDE  | P  | –     | –      |
| PHOSPHINE  | –  | 2.3   | 2199   |
| PHOSPHINE, ADSORBED  | –  | 2.3   | 3525   |
| Phosphoretted hydrogen, <i>see</i>   | –  | 2.3   | 2199   |
| PHOSPHORIC ACID, SOLID   | –  | 8     | 3453   |
| PHOSPHORIC ACID, SOLUTION  | –  | 8     | 1805   |
| Phosphoric anhydride, <i>see</i>   | –  | 8     | 1807   |
| Phosphoric chloride, <i>see</i>  | –  | 8     | 1806   |
| Phosphoric pentachloride, <i>see</i>   | –  | 8     | 1806   |
| Phosphoric perchloride, <i>see</i>   | –  | 8     | 1806   |
| Phosphorothioic acid, <i>o</i> -[(cyanophenyl methylene) azanyl] <i>o,o</i> -diethyl ester (concentration 82-91% (Z isomer)), <i>see</i> | –  | 4.1   | 3227   |
| PHOSPHOROUS ACID   | –  | 8     | 2834   |
| PHOSPHORUS, AMORPHOUS  | –  | 4.1   | 1338   |
| Phosphorus bromide, <i>see</i>   | –  | 8     | 1808   |
| Phosphorus chloride, <i>see</i>  | –  | 6.1   | 1809   |
| PHOSPHORUS HEPTASULPHIDE, free from yellow or white phosphorus   | –  | 4.1   | 1339   |
| PHOSPHORUS OXYBROMIDE  | –  | 8     | 1939   |
| PHOSPHORUS OXYBROMIDE, MOLTEN  | –  | 8     | 2576   |
| PHOSPHORUS OXYCHLORIDE   | –  | 6.1   | 1810   |
| PHOSPHORUS PENTABROMIDE  | –  | 8     | 2691   |
| PHOSPHORUS PENTACHLORIDE   | –  | 8     | 1806   |

## Index

| Substance, material or article  | MP | Class | UN No. |
|---|----|-------|--------|
| PHOSPHORUS PENTAFLUORIDE  | –  | 2.3   | 2198   |
| PHOSPHORUS PENTAFLUORIDE, ADSORBED                                    | –  | 2.3   | 3524   |
| PHOSPHORUS PENTASULPHIDE, free from yellow or white phosphorus        | –  | 4.3   | 1340   |
| PHOSPHORUS PENTOXIDE  | –  | 8     | 1807   |
| Phosphorus, red, see  | –  | 4.1   | 1338   |
| PHOSPHORUS SESQUISULPHIDE, free from yellow or white phosphorus       | –  | 4.1   | 1341   |
| Phosphorus(V) sulphide, free from yellow or white phosphorus, see     | –  | 4.3   | 1340   |
| Phosphorus sulphochloride, see  | –  | 8     | 1837   |
| PHOSPHORUS TRIBROMIDE   | –  | 8     | 1808   |
| PHOSPHORUS TRICHLORIDE  | –  | 6.1   | 1809   |
| PHOSPHORUS TRIOXIDE   | –  | 8     | 2578   |
| PHOSPHORUS TRISULPHIDE, free from yellow or white phosphorus          | –  | 4.1   | 1343   |
| PHOSPHORUS, WHITE, DRY  | P  | 4.2   | 1381   |
| PHOSPHORUS, WHITE, IN SOLUTION  | P  | 4.2   | 1381   |
| PHOSPHORUS, WHITE, MOLTEN   | P  | 4.2   | 2447   |
| PHOSPHORUS, WHITE, UNDER WATER  | P  | 4.2   | 1381   |
| PHOSPHORUS, YELLOW, DRY   | P  | 4.2   | 1381   |
| PHOSPHORUS, YELLOW, IN SOLUTION                                       | P  | 4.2   | 1381   |
| PHOSPHORUS, YELLOW, UNDER WATER                                       | P  | 4.2   | 1381   |
| Phosphoryl bromide, molten, see                                       | –  | 8     | 2576   |
| Phosphoryl bromide, solid, see  | –  | 8     | 1939   |
| Phosphoryl chloride, see  | –  | 6.1   | 1810   |
| PHTHALIC ANHYDRIDE with more than 0.05% of maleic anhydride           | –  | 8     | 2214   |
| PICOLINES   | –  | 3     | 2313   |
| Picramic acid, wetted with not less than 20% water, by mass, see      | –  | 4.1   | 3317   |
| PICRAMIDE   | –  | 1.1D  | 0153   |
| PICRIC ACID, dry or wetted with less than 30% water, by mass          | –  | 1.1D  | 0154   |
| PICRIC ACID, WETTED with not less than 10% water, by mass             | –  | 4.1   | 3364   |
| PICRIC ACID, WETTED with not less than 30% water, by mass             | –  | 4.1   | 1344   |
| PICRITE, dry or wetted with less than 20% water, by mass              | –  | 1.1D  | 0282   |
| PICRITE, WETTED with not less than 20% water, by mass                 | –  | 4.1   | 1336   |
| Picrotoxin, see   | –  | 6.1   | 3172   |
| Picrotoxin, see   | –  | 6.1   | 3462   |
| PICRYL CHLORIDE   | –  | 1.1D  | 0155   |
| PICRYL CHLORIDE, WETTED with not less than 10% water, by mass         | –  | 4.1   | 3365   |
| Pinanyl hydroperoxide (concentration ≤ 56%, with diluent Type A), see | –  | 5.2   | 3109   |
| Pinanyl hydroperoxide (concentration > 56–100%), see                  | –  | 5.2   | 3105   |
| Pindone (and salts of), see PESTICIDE, N.O.S.                         | P  | –     | –      |
| <i>alpha</i> -PINENE  | P  | 3     | 2368   |
| PINE OIL  | P  | 3     | 1272   |
| PIPERAZINE  | –  | 8     | 2579   |

| Substance, material or article   | MP | Class | UN No. |
|--|----|-------|--------|
| PIPERIDINE   | –  | 8     | 2401   |
| Pirimicarb, <i>see</i> CARBAMATE PESTICIDE   | P  | –     | –      |
| Pirimiphos-ethyl, <i>see</i> ORGANOPHOSPHORUS PESTICIDE  | P  | –     | –      |
| Pivaloyl chloride, <i>see</i>  | –  | 6.1   | 2438   |
| Plastic explosives, <i>see</i>   | –  | 1.1D  | 0084   |
| PLASTICS MOULDING COMPOUND in dough, sheet or extruded rope form, evolving flammable vapour              | –  | 9     | 3314   |
| PLASTICS, NITROCELLULOSE-BASED, SELF-HEATING, N.O.S.   | –  | 4.2   | 2006   |
| Platinic chloride, solid, <i>see</i>   | –  | 8     | 2507   |
| Polish, <i>see</i> PAINT   | –  | –     | –      |
| POLYAMINES, FLAMMABLE, CORROSIVE, N.O.S.   | –  | 3     | 2733   |
| POLYAMINES, LIQUID, CORROSIVE, FLAMMABLE, N.O.S.   | –  | 8     | 2734   |
| POLYAMINES, LIQUID, CORROSIVE, N.O.S.  | –  | 8     | 2735   |
| POLYAMINES, SOLID, CORROSIVE, N.O.S.   | –  | 8     | 3259   |
| POLYCHLORINATED BIPHENYLS, LIQUID  | P  | 9     | 2315   |
| POLYCHLORINATED BIPHENYLS, SOLID   | P  | 9     | 3432   |
| POLYESTER RESIN KIT, liquid base material  | –  | 3     | 3269   |
| POLYESTER RESIN KIT, solid base material   | –  | 4.1   | 3527   |
| Polyether poly- <i>tert</i> -butylperoxycarbonate (concentration ≤ 52%, with diluent Type B), <i>see</i> | –  | 5.2   | 3107   |
| POLYHALOGENATED BIPHENYLS, LIQUID  | P  | 9     | 3151   |
| POLYHALOGENATED BIPHENYLS, SOLID   | P  | 9     | 3152   |
| POLYHALOGENATED TERPHENYLS, LIQUID   | P  | 9     | 3151   |
| POLYHALOGENATED TERPHENYLS, SOLID  | P  | 9     | 3152   |
| POLYMERIC BEADS, EXPANDABLE, evolving flammable vapour   | –  | 9     | 2211   |
| POLYMERIZING SUBSTANCE, LIQUID, STABILIZED, N.O.S.   | –  | 4.1   | 3532   |
| POLYMERIZING SUBSTANCE, LIQUID, TEMPERATURE CONTROLLED, N.O.S.   | –  | 4.1   | 3534   |
| POLYMERIZING SUBSTANCE, SOLID, STABILIZED, N.O.S.  | –  | 4.1   | 3531   |
| POLYMERIZING SUBSTANCE, SOLID, TEMPERATURE CONTROLLED, N.O.S.  | –  | 4.1   | 3533   |
| Polystyrene beads, expandable, <i>see</i>  | –  | 9     | 2211   |
| Polystyrene beads, expandable, evolving flammable vapour, <i>see</i>                                     | –  | 9     | 2211   |
| POTASSIUM  | –  | 4.3   | 2257   |
| Potassium acid fluoride, solid, <i>see</i>   | –  | 8     | 1811   |
| Potassium acid fluoride solution, <i>see</i>   | –  | 8     | 1811   |
| Potassium alloys, metal, <i>see</i>  | –  | 4.3   | 1420   |
| Potassium amalgams, liquid, <i>see</i>   | –  | 4.3   | 1389   |
| Potassium amalgams, solid, <i>see</i>  | –  | 4.3   | 3401   |
| Potassium amide, <i>see</i>  | –  | 4.3   | 1390   |
| Potassium antimony tartrate, <i>see</i>  | –  | 6.1   | 1551   |
| POTASSIUM ARSENATE   | –  | 6.1   | 1677   |
| POTASSIUM ARSENITE   | –  | 6.1   | 1678   |
| Potassium bifluoride, solid, <i>see</i>  | –  | 8     | 1811   |



## Index

| Substance, material or article                           | MP | Class | UN No. |
|--|----|-------|--------|
| Potassium bifluoride solution, <i>see</i>                | –  | 8     | 3421   |
| Potassium bisulphate, <i>see</i>                         | –  | 8     | 2509   |
| Potassium bisulphite solution, <i>see</i>                | –  | 8     | 2693   |
| POTASSIUM BOROHYDRIDE                                    | –  | 4.3   | 1870   |
| POTASSIUM BROMATE  | –  | 5.1   | 1484   |
| POTASSIUM CHLORATE                                       | –  | 5.1   | 1485   |
| POTASSIUM CHLORATE, AQUEOUS SOLUTION                     | –  | 5.1   | 2427   |
| Potassium chlorate mixed with mineral oil, <i>see</i>    | –  | 1.1D  | 0083   |
| POTASSIUM CUPROCYANIDE                                   | P  | 6.1   | 1679   |
| POTASSIUM CYANIDE, SOLID                                 | P  | 6.1   | 1680   |
| POTASSIUM CYANIDE SOLUTION                               | P  | 6.1   | 3413   |
| Potassium cyanocuprate(I), <i>see</i>                    | P  | 6.1   | 1679   |
| Potassium cyanomercurate, <i>see</i>                     | P  | 6.1   | 1626   |
| Potassium dicyanocuprate(I), <i>see</i>                  | –  | 6.1   | 1679   |
| Potassium dihydrogen arsenate, <i>see</i>                | –  | 6.1   | 1677   |
| Potassium dispersions, <i>see</i>                        | –  | 4.3   | 1391   |
| POTASSIUM DITHIONITE                                     | –  | 4.2   | 1929   |
| POTASSIUM FLUORIDE, SOLID                                | –  | 6.1   | 1812   |
| POTASSIUM FLUORIDE SOLUTION                              | –  | 6.1   | 3422   |
| POTASSIUM FLUOROACETATE                                  | –  | 6.1   | 2628   |
| POTASSIUM FLUROSILICATE                                  | –  | 6.1   | 2655   |
| Potassium hexafluorosilicate, <i>see</i>                 | –  | 6.1   | 2655   |
| Potassium hydrate, <i>see</i>                            | –  | 8     | 1814   |
| POTASSIUM HYDROGEN DIFLUORIDE, SOLID                     | –  | 8     | 1811   |
| POTASSIUM HYDROGEN DIFLUORIDE SOLUTION                   | –  | 8     | 3421   |
| Potassium hydrogen fluoride, solid, <i>see</i>           | –  | 8     | 1811   |
| Potassium hydrogen fluoride solution, <i>see</i>         | –  | 8     | 3421   |
| POTASSIUM HYDROGEN SULPHATE                              | –  | 8     | 2509   |
| POTASSIUM HYDROSULPHITE                                  | –  | 4.2   | 1929   |
| Potassium hydroxide, liquid, <i>see</i>                  | –  | 8     | 1814   |
| POTASSIUM HYDROXIDE, SOLID                               | –  | 8     | 1813   |
| POTASSIUM HYDROXIDE SOLUTION                             | –  | 8     | 1814   |
| Potassium hypochlorite solution, <i>see</i>              | –  | 8     | 1791   |
| Potassium mercuric iodide, <i>see</i>                    | P  | 6.1   | 1643   |
| POTASSIUM METAL ALLOYS, LIQUID                           | –  | 4.3   | 1420   |
| POTASSIUM METAL ALLOYS, SOLID                            | –  | 4.3   | 3403   |
| POTASSIUM METAVANADATE                                   | –  | 6.1   | 2864   |
| POTASSIUM MONOXIDE                                       | –  | 8     | 2033   |
| POTASSIUM NITRATE  | –  | 5.1   | 1486   |
| Potassium nitrate and sodium nitrate mixture, <i>see</i> | –  | 5.1   | 1499   |
| POTASSIUM NITRATE AND SODIUM NITRITE MIXTURE             | –  | 5.1   | 1487   |
| POTASSIUM NITRITE  | –  | 5.1   | 1488   |
| Potassium oxide, <i>see</i>                              | –  | 8     | 2033   |

| Substance, material or article  | MP | Class | UN No. |
|---|----|-------|--------|
| POTASSIUM PERCHLORATE   | –  | 5.1   | 1489   |
| POTASSIUM PERMANGANATE  | –  | 5.1   | 1490   |
| POTASSIUM PEROXIDE  | –  | 5.1   | 1491   |
| POTASSIUM PERSULPHATE   | –  | 5.1   | 1492   |
| POTASSIUM PHOSPHIDE   | –  | 4.3   | 2012   |
| Potassium silicofluoride, <i>see</i>  | –  | 6.1   | 2655   |
| POTASSIUM SODIUM ALLOYS, LIQUID   | –  | 4.3   | 1422   |
| POTASSIUM SODIUM ALLOYS, SOLID  | –  | 4.3   | 3404   |
| POTASSIUM SULPHIDE, ANHYDROUS   | –  | 4.2   | 1382   |
| POTASSIUM SULPHIDE, HYDRATED with not less than 30% water of crystallization                    | –  | 8     | 1847   |
| POTASSIUM SULPHIDE with less than 30% water of crystallization                                  | –  | 4.2   | 1382   |
| POTASSIUM SUPEROXIDE  | –  | 5.1   | 2466   |
| Potassium tetracyanomercurate(II), <i>see</i>   | –  | 6.1   | 1626   |
| Potassium vanadate, <i>see</i>  | –  | 6.1   | 2864   |
| POWDER CAKE, WETTED with not less than 17% alcohol, by mass                                     | –  | 1.1C  | 0433   |
| POWDER CAKE, WETTED with not less than 25% water, by mass                                       | –  | 1.3C  | 0159   |
| POWDER PASTE, WETTED with not less than 17% alcohol, by mass                                    | –  | 1.1C  | 0433   |
| POWDER PASTE, WETTED with not less than 25% water, by mass                                      | –  | 1.3C  | 0159   |
| POWDER, SMOKELESS   | –  | 1.1C  | 0160   |
| POWDER, SMOKELESS   | –  | 1.3C  | 0161   |
| POWDER, SMOKELESS   | –  | 1.4C  | 0509   |
| Power devices, explosive, <i>see</i> CARTRIDGES, POWER DEVICE                                   | –  | –     | –      |
| Praseodymium nitrate and neodymium nitrate mixture, <i>see</i>                                  | –  | 5.1   | 1465   |
| PRIMERS, CAP TYPE   | –  | 1.1B  | 0377   |
| PRIMERS, CAP TYPE   | –  | 1.4B  | 0378   |
| PRIMERS, CAP TYPE   | –  | 1.4S  | 0044   |
| Primers, small arms, <i>see</i>   | –  | 1.4S  | 0044   |
| PRIMERS, TUBULAR  | –  | 1.3G  | 0319   |
| PRIMERS, TUBULAR  | –  | 1.4G  | 0320   |
| PRIMERS, TUBULAR  | –  | 1.4S  | 0376   |
| PRINTING INK, flammable   | –  | 3     | 1210   |
| PRINTING INK RELATED MATERIAL (including printing ink thinning or reducing compound), flammable | –  | 3     | 1210   |
| Projectiles, illuminating, <i>see</i> AMMUNITION, ILLUMINATING                                  | –  | –     | –      |
| PROJECTILES, inert with tracer  | –  | 1.3G  | 0424   |
| PROJECTILES, inert with tracer  | –  | 1.4G  | 0425   |
| PROJECTILES, inert with tracer  | –  | 1.4S  | 0345   |
| PROJECTILES with burster or expelling charge  | –  | 1.2D  | 0346   |
| PROJECTILES with burster or expelling charge  | –  | 1.2F  | 0426   |
| PROJECTILES with burster or expelling charge  | –  | 1.2G  | 0434   |
| PROJECTILES with burster or expelling charge  | –  | 1.4D  | 0347   |
| PROJECTILES with burster or expelling charge  | –  | 1.4F  | 0427   |
| PROJECTILES with burster or expelling charge  | –  | 1.4G  | 0435   |

## Index

| Substance, material or article   | MP | Class | UN No. |
|--|----|-------|--------|
| PROJECTILES with bursting charge   | –  | 1.1D  | 0168   |
| PROJECTILES with bursting charge   | –  | 1.1F  | 0167   |
| PROJECTILES with bursting charge   | –  | 1.2D  | 0169   |
| PROJECTILES with bursting charge   | –  | 1.2F  | 0324   |
| PROJECTILES with bursting charge   | –  | 1.4D  | 0344   |
| Promecarb, see CARBAMATE PESTICIDE                                       | P  | –     | –      |
| Promurit, see CARBAMATE PESTICIDE  | –  | –     | –      |
| Propachlor, see Note 1   | P  | –     | –      |
| Propadiene and methylacetylene mixture, stabilized, see                  | –  | 2.1   | 1060   |
| PROPADIENE, STABILIZED   | –  | 2.1   | 2200   |
| PROPANE  | –  | 2.1   | 1978   |
| PROPANETHIOLS  | –  | 3     | 2402   |
| <i>n</i> -PROPANOL (PROPYL ALCOHOL, NORMAL)                              | –  | 3     | 1274   |
| 1-Propanol, see  | –  | 3     | 1274   |
| 2-Propanol, see  | –  | 3     | 1219   |
| 2-Propanone, see   | –  | 3     | 1090   |
| 2-Propanone solutions, see   | –  | 3     | 1090   |
| Propanoyl chloride, see  | –  | 3     | 1815   |
| Propaphos, see ORGANOPHOSPHORUS PESTICIDE                                | P  | –     | –      |
| Propargyl bromide, see   | –  | 3     | 2345   |
| PROPELLANT, LIQUID   | –  | 1.1C  | 0497   |
| PROPELLANT, LIQUID   | –  | 1.3C  | 0495   |
| PROPELLANT, SOLID  | –  | 1.1C  | 0498   |
| PROPELLANT, SOLID  | –  | 1.3C  | 0499   |
| PROPELLANT, SOLID  | –  | 1.4C  | 0501   |
| Propellants, single, double or triple base, see POWDER, SMOKELESS        | –  | –     | –      |
| Propenal, stabilized, see  | P  | 6.1   | 1092   |
| Propene, see   | –  | 2.1   | 1077   |
| Propenenitrile, stabilized, see  | –  | 3     | 1093   |
| 2-Propenoic acid dimethylaminoethyl ester, see                           | –  | 6.1   | 3302   |
| Propenoic acid, stabilized, see  | P  | 8     | 2218   |
| 3-(2-Propenoxy)propene, see  | –  | 3     | 2360   |
| Propenyl alcohol, see  | P  | 6.1   | 1098   |
| 2-Propenylamine, see   | –  | 6.1   | 2334   |
| <i>alpha</i> -Propenyldichlorohydrin, see                                | –  | 6.1   | 2750   |
| PROPIONALDEHYDE  | –  | 3     | 1275   |
| PROPIONIC ACID with not less than 10% and less than 90% acid,<br>by mass | –  | 8     | 1848   |
| PROPIONIC ACID with not less than 90% acid, by mass                      | –  | 8     | 3463   |
| Propionic aldehyde, see  | –  | 3     | 1275   |
| PROPIONIC ANHYDRIDE  | –  | 8     | 2496   |
| PROPIONITRILE  | –  | 3     | 2404   |
| PROPIONYL CHLORIDE   | –  | 3     | 1815   |

| Substance, material or article   | MP | Class | UN No. |
|--|----|-------|--------|
| Propoxur, <i>see</i> CARBAMATE PESTICIDE   | P  | –     | –      |
| 1-Propoxypropane, <i>see</i>   | –  | 3     | 2384   |
| <i>n</i> -PROPYL ACETATE   | –  | 3     | 1276   |
| <i>n</i> -Propyl alcohol, <i>see</i>   | –  | 3     | 1274   |
| PROPYL ALCOHOL, NORMAL   | –  | 3     | 1274   |
| Propyl aldehyde, <i>see</i>  | –  | 3     | 1275   |
| PROPYLAMINE  | –  | 3     | 1277   |
| <i>n</i> -PROPYLBENZENE  | –  | 3     | 2364   |
| Propyl bromides, <i>see</i>  | –  | 3     | 2344   |
| Propyl chloride, <i>see</i>  | –  | 3     | 1278   |
| Propyl chlorocarbonate, <i>see</i>   | –  | 6.1   | 2740   |
| <i>n</i> -PROPYL CHLOROFORMATE   | –  | 6.1   | 2740   |
| Propyl cyanide, <i>see</i>   | –  | 3     | 2411   |
| PROPYLENE  | –  | 2.1   | 1077   |
| Propylene, acetylene and ethylene mixture, refrigerated liquid, <i>see</i>   | –  | 2.1   | 3138   |
| PROPYLENE CHLOROHYDRIN   | –  | 6.1   | 2611   |
| 1,2-PROPYLENEDIAMINE   | –  | 8     | 2258   |
| Propylene dichloride, <i>see</i>   | –  | 3     | 1279   |
| PROPYLENEIMINE, STABILIZED   | –  | 3     | 1921   |
| PROPYLENE OXIDE  | –  | 3     | 1280   |
| PROPYLENE TETRAMER   | P  | 3     | 2850   |
| Propylene trimer, <i>see</i>   | –  | 3     | 2057   |
| Propyl ether, <i>see</i>   | –  | 3     | 2384   |
| PROPYL FORMATES  | –  | 3     | 1281   |
| Propylformic acid, <i>see</i>  | –  | 8     | 2820   |
| Propylidene dichloride, <i>see</i>   | –  | 3     | 1993   |
| Propyl iodides, <i>see</i>   | –  | 3     | 2392   |
| <i>n</i> -PROPYL ISOCYANATE  | –  | 6.1   | 2482   |
| Propyl mercaptan, <i>see</i>   | –  | 3     | 2402   |
| Propyl methanoates, <i>see</i>   | –  | 3     | 1281   |
| <i>n</i> -PROPYL NITRATE   | –  | 3     | 1865   |
| PROPYLTRICHLOROSILANE  | –  | 8     | 1816   |
| Prothoate, <i>see</i> ORGANOPHOSPHORUS PESTICIDE   | P  | –     | –      |
| Prussic acid, anhydrous, stabilized, containing less than 3% water, <i>see</i>   | P  | 6.1   | 1051   |
| Prussic acid, anhydrous, stabilized, containing less than 3% water and absorbed in a porous inert material, <i>see</i> | P  | 6.1   | 1614   |
| Prussic acid, aqueous solution, <i>see</i>   | P  | 6.1   | 1613   |
| Prussic acid, aqueous solution with not more than 20% hydrogen cyanide, <i>see</i>                                     | P  | 6.1   | 1613   |
| Pyrazine hexahydride, solid, <i>see</i>  | –  | 8     | 2579   |
| Pyrazophos, <i>see</i> ORGANOPHOSPHORUS PESTICIDE  | P  | –     | –      |
| Pyrazoxon, <i>see</i> ORGANOPHOSPHORUS PESTICIDE   | –  | –     | –      |
| PYRETHROID PESTICIDE, LIQUID, FLAMMABLE, TOXIC, flashpoint less than 23°C  | –  | 3     | 3350   |

Index

| Substance, material or article  | MP | Class | UN No. |
|---|----|-------|--------|
| PYRETHROID PESTICIDE, LIQUID, TOXIC   | –  | 6.1   | 3352   |
| PYRETHROID PESTICIDE, LIQUID, TOXIC, FLAMMABLE, flashpoint not less than 23°C         | –  | 6.1   | 3351   |
| PYRETHROID PESTICIDE, SOLID, TOXIC  | –  | 6.1   | 3349   |
| PYRIDINE  | –  | 3     | 1282   |
| PYROPHORIC ALLOY, N.O.S.  | –  | 4.2   | 1383   |
| Pyrophoric articles, see  | –  | 1.2L  | 0380   |
| PYROPHORIC LIQUID, INORGANIC, N.O.S.  | –  | 4.2   | 3194   |
| PYROPHORIC LIQUID, ORGANIC, N.O.S.  | –  | 4.2   | 2845   |
| PYROPHORIC METAL, N.O.S.  | –  | 4.2   | 1383   |
| Pyrophoric organometallic compound, water-reactive, liquid, see                       | –  | 4.2   | 3394   |
| Pyrophoric organometallic compound, water-reactive, solid, see                        | –  | 4.2   | 3393   |
| PYROPHORIC SOLID, INORGANIC, N.O.S.   | –  | 4.2   | 3200   |
| PYROPHORIC SOLID, ORGANIC, N.O.S.   | –  | 4.2   | 2846   |
| Pyrosulphuric acid, see   | –  | 8     | 1831   |
| PYROSULPHURYL CHLORIDE  | –  | 8     | 1817   |
| Pyroxylin solution, see   | –  | 3     | 2059   |
| PYRROLIDINE   | –  | 3     | 1922   |
| Quinalphos, see ORGANOPHOSPHORUS PESTICIDE  | P  | –     | –      |
| QUINOLINE   | –  | 6.1   | 2656   |
| Quinone, see  | –  | 6.1   | 2587   |
| Quizalofop, see Note 1  | P  | –     | –      |
| Quizalofop-P-ethyl, see Note 1  | P  | –     | –      |
| Racumin, see COUMARIN DERIVATIVE PESTICIDE  | –  | –     | –      |
| Radioactive isotopes ( $A_1$ and $A_2$ values for), see 2.7.2.2                       | –  | –     | –      |
| RADIOACTIVE MATERIAL, EXCEPTED PACKAGE – ARTICLES                                     | –  | 7     | 2911   |
| RADIOACTIVE MATERIAL, EXCEPTED PACKAGE – ARTICLES MANUFACTURED FROM DEPLETED URANIUM  | –  | 7     | 2909   |
| RADIOACTIVE MATERIAL, EXCEPTED PACKAGE – ARTICLES MANUFACTURED FROM NATURAL THORIUM   | –  | 7     | 2909   |
| RADIOACTIVE MATERIAL, EXCEPTED PACKAGE – ARTICLES MANUFACTURED FROM NATURAL URANIUM   | –  | 7     | 2909   |
| RADIOACTIVE MATERIAL, EXCEPTED PACKAGE – EMPTY PACKAGING                              | –  | 7     | 2908   |
| RADIOACTIVE MATERIAL, EXCEPTED PACKAGE – INSTRUMENTS                                  | –  | 7     | 2911   |
| RADIOACTIVE MATERIAL, EXCEPTED PACKAGE – LIMITED QUANTITY OF MATERIAL                 | –  | 7     | 2910   |
| RADIOACTIVE MATERIAL, LOW SPECIFIC ACTIVITY (LSA-II), FISSILE                         | –  | 7     | 3324   |
| RADIOACTIVE MATERIAL, LOW SPECIFIC ACTIVITY (LSA-III), FISSILE                        | –  | 7     | 3325   |
| RADIOACTIVE MATERIAL, LOW SPECIFIC ACTIVITY (LSA-I), non fissile or fissile-excepted  | –  | 7     | 2912   |
| RADIOACTIVE MATERIAL, LOW SPECIFIC ACTIVITY (LSA-II), non fissile or fissile-excepted | –  | 7     | 3321   |

| Substance, material or article   | MP | Class | UN No. |
|--|----|-------|--------|
| RADIOACTIVE MATERIAL, LOW SPECIFIC ACTIVITY (LSA-III), non fissile or fissile-excepted                         | –  | 7     | 3322   |
| RADIOACTIVE MATERIAL, SURFACE CONTAMINATED OBJECTS (SCO-I or SCO-II), FISSILE                                  | –  | 7     | 3326   |
| RADIOACTIVE MATERIAL, SURFACE CONTAMINATED OBJECTS (SCO-I, SCO-II or SCO-III), non fissile or fissile-excepted | –  | 7     | 2913   |
| RADIOACTIVE MATERIAL, TRANSPORTED UNDER SPECIAL ARRANGEMENT, FISSILE   | –  | 7     | 3331   |
| RADIOACTIVE MATERIAL TRANSPORTED UNDER SPECIAL ARRANGEMENT non fissile or fissile-excepted                     | –  | 7     | 2919   |
| RADIOACTIVE MATERIAL, TYPE A PACKAGE, FISSILE, non-special form  | –  | 7     | 3327   |
| RADIOACTIVE MATERIAL, TYPE A PACKAGE, non-special form, non fissile or fissile-excepted                        | –  | 7     | 2915   |
| RADIOACTIVE MATERIAL, TYPE A PACKAGE, SPECIAL FORM, FISSILE  | –  | 7     | 3333   |
| RADIOACTIVE MATERIAL, TYPE A PACKAGE, SPECIAL FORM, non fissile or fissile-excepted                            | –  | 7     | 3332   |
| RADIOACTIVE MATERIAL, TYPE B(M) PACKAGE, FISSILE   | –  | 7     | 3329   |
| RADIOACTIVE MATERIAL, TYPE B(M) PACKAGE, non fissile or fissile-excepted                                       | –  | 7     | 2917   |
| RADIOACTIVE MATERIAL TYPE B(U) PACKAGE, FISSILE  | –  | 7     | 3328   |
| RADIOACTIVE MATERIAL, TYPE B(U) PACKAGE, non fissile or fissile-excepted                                       | –  | 7     | 2916   |
| RADIOACTIVE MATERIAL, TYPE C PACKAGE, FISSILE  | –  | 7     | 3330   |
| RADIOACTIVE MATERIAL, TYPE C PACKAGE, non fissile or fissile-excepted  | –  | 7     | 3323   |
| RADIOACTIVE MATERIAL, URANIUM HEXAFLUORIDE, FISSILE  | –  | 7     | 2977   |
| RADIOACTIVE MATERIAL, URANIUM HEXAFLUORIDE, non fissile or fissile-excepted                                    | –  | 7     | 2978   |
| Radionuclides ( $A_1$ and $A_2$ values for), see 2.7.2.2   | –  | –     | –      |
| RAGS, OILY   | –  | 4.2   | 1856   |
| Railway fusees, see SIGNAL DEVICES, HAND   | –  | –     | –      |
| RDX AND CYCLOTETRAMETHYLENETETRANITRAMINE MIXTURE, DESENSITIZED with not less than 10% phlegmatizer, by mass   | –  | 1.1D  | 0391   |
| RDX AND CYCLOTETRAMETHYLENETETRANITRAMINE MIXTURE, WETTED with not less than 15% water, by mass                | –  | 1.1D  | 0391   |
| RDX AND HMX MIXTURE, DESENSITIZED with not less than 10% phlegmatizer, by mass                                 | –  | 1.1D  | 0391   |
| RDX AND HMX MIXTURE, WETTED with not less than 15% water, by mass  | –  | 1.1D  | 0391   |
| RDX AND OCTOGEN MIXTURE, DESENSITIZED with not less than 10% phlegmatizer, by mass                             | –  | 1.1D  | 0391   |
| RDX AND OCTOGEN MIXTURE, WETTED with not less than 15% water, by mass  | –  | 1.1D  | 0391   |
| RDX, DESENSITIZED  | –  | 1.1D  | 0483   |
| RDX/TNT, see   | –  | 1.1D  | 0118   |
| RDX/TNT/aluminium, see   | –  | 1.1D  | 0393   |
| RDX, WETTED with not less than 15% water, by mass  | –  | 1.1D  | 0072   |



## Index

| Substance, material or article  | MP | Class | UN No. |
|---|----|-------|--------|
| RECEPTACLES, SMALL, CONTAINING GAS without a release device, non refillable                     | –  | 2     | 2037   |
| Red phosphorus, see   | –  | 4.1   | 1338   |
| REFRIGERANT GAS, N.O.S.   | –  | 2.2   | 1078   |
| REFRIGERANT GAS R 12  | –  | 2.2   | 1028   |
| REFRIGERANT GAS R 12B1  | –  | 2.2   | 1974   |
| REFRIGERANT GAS R 13  | –  | 2.2   | 1022   |
| REFRIGERANT GAS R 13B1  | –  | 2.2   | 1009   |
| REFRIGERANT GAS R 14  | –  | 2.2   | 1982   |
| REFRIGERANT GAS R 21  | –  | 2.2   | 1029   |
| REFRIGERANT GAS R 22  | –  | 2.2   | 1018   |
| REFRIGERANT GAS R 23  | –  | 2.2   | 1984   |
| REFRIGERANT GAS R 32  | –  | 2.1   | 3252   |
| REFRIGERANT GAS R 40  | –  | 2.1   | 1063   |
| REFRIGERANT GAS R 41  | –  | 2.1   | 2454   |
| REFRIGERANT GAS R 114   | –  | 2.2   | 1958   |
| REFRIGERANT GAS R 115   | –  | 2.2   | 1020   |
| REFRIGERANT GAS R 116   | –  | 2.2   | 2193   |
| REFRIGERANT GAS R 124   | –  | 2.2   | 1021   |
| REFRIGERANT GAS R 125   | –  | 2.2   | 3220   |
| REFRIGERANT GAS R 133a  | –  | 2.2   | 1983   |
| REFRIGERANT GAS R 134a  | –  | 2.2   | 3159   |
| REFRIGERANT GAS R 142b  | –  | 2.1   | 2517   |
| REFRIGERANT GAS R 143a  | –  | 2.1   | 2035   |
| REFRIGERANT GAS R 152a  | –  | 2.1   | 1030   |
| REFRIGERANT GAS R 161   | –  | 2.1   | 2453   |
| REFRIGERANT GAS R 218   | –  | 2.2   | 2424   |
| REFRIGERANT GAS R 227   | –  | 2.2   | 3296   |
| REFRIGERANT GAS R 404A  | –  | 2.2   | 3337   |
| REFRIGERANT GAS R 407A  | –  | 2.2   | 3338   |
| REFRIGERANT GAS R 407B  | –  | 2.2   | 3339   |
| REFRIGERANT GAS R 407C  | –  | 2.2   | 3340   |
| REFRIGERANT GAS R 500   | –  | 2.2   | 2602   |
| REFRIGERANT GAS R 502   | –  | 2.2   | 1973   |
| REFRIGERANT GAS R 503   | –  | 2.2   | 2599   |
| REFRIGERANT GAS R 1113  | –  | 2.3   | 1082   |
| REFRIGERANT GAS R 1132a   | –  | 2.1   | 1959   |
| REFRIGERANT GAS R 1216  | –  | 2.2   | 1858   |
| REFRIGERANT GAS R 1318  | –  | 2.2   | 2422   |
| REFRIGERANT GAS RC 318  | –  | 2.2   | 1976   |
| REFRIGERATING MACHINES containing flammable, non-toxic, liquefied gas                           | –  | 2.1   | 3358   |
| REFRIGERATING MACHINES containing non-flammable, non-toxic, gases or ammonia solution (UN 2672) | –  | 2.2   | 2857   |

| Substance, material or article  | MP | Class | UN No. |
|---|----|-------|--------|
| REGULATED MEDICAL WASTE, N.O.S.   | –  | 6.2   | 3291   |
| RELEASE DEVICES, EXPLOSIVE  | –  | 1.4S  | 0173   |
| RESIN SOLUTION, flammable   | –  | 3     | 1866   |
| Resorcin, <i>see</i>  | –  | 6.1   | 2876   |
| RESORCINOL  | –  | 6.1   | 2876   |
| RIVETS, EXPLOSIVE   | –  | 1.4S  | 0174   |
| Road asphalt, <i>see</i>  | –  | 3     | 1999   |
| ROCKET MOTORS   | –  | 1.1C  | 0280   |
| ROCKET MOTORS   | –  | 1.2C  | 0281   |
| ROCKET MOTORS   | –  | 1.3C  | 0186   |
| ROCKET MOTORS   | –  | 1.4C  | 0510   |
| ROCKET MOTORS, LIQUID FUELLED   | –  | 1.2J  | 0395   |
| ROCKET MOTORS, LIQUID FUELLED   | –  | 1.3J  | 0396   |
| ROCKET MOTORS WITH HYPERGOLIC LIQUIDS with or without expelling charge                            | –  | 1.2L  | 0322   |
| ROCKET MOTORS WITH HYPERGOLIC LIQUIDS with or without expelling charge                            | –  | 1.3L  | 0250   |
| ROCKETS, LINE-THROWING  | –  | 1.2G  | 0238   |
| ROCKETS, LINE-THROWING  | –  | 1.3G  | 0240   |
| ROCKETS, LINE-THROWING  | –  | 1.4G  | 0453   |
| ROCKETS, LIQUID FUELLED with bursting charge  | –  | 1.1J  | 0397   |
| ROCKETS, LIQUID FUELLED with bursting charge  | –  | 1.2J  | 0398   |
| ROCKETS with bursting charge  | –  | 1.1E  | 0181   |
| ROCKETS with bursting charge  | –  | 1.1F  | 0180   |
| ROCKETS with bursting charge  | –  | 1.2E  | 0182   |
| ROCKETS with bursting charge  | –  | 1.2F  | 0295   |
| ROCKETS with expelling charge   | –  | 1.2C  | 0436   |
| ROCKETS with expelling charge   | –  | 1.3C  | 0437   |
| ROCKETS with expelling charge   | –  | 1.4C  | 0438   |
| ROCKETS with inert head   | –  | 1.2C  | 0502   |
| ROCKETS with inert head   | –  | 1.3C  | 0183   |
| ROSIN OIL   | –  | 3     | 1286   |
| Rotenone, <i>see</i> PESTICIDE, N.O.S.  | P  | –     | –      |
| RUBBER SCRAP, powdered or granulated, not exceeding 840 microns and rubber content exceeding 45%  | –  | 4.1   | 1345   |
| RUBBER SHODDY, powdered or granulated, not exceeding 840 microns and rubber content exceeding 45% | –  | 4.1   | 1345   |
| RUBBER SOLUTION   | –  | 3     | 1287   |
| RUBIDIUM  | –  | 4.3   | 1423   |
| Rubidium alloy (liquid), <i>see</i>   | –  | 4.3   | 1421   |
| Rubidium amalgams, liquid, <i>see</i>   | –  | 4.3   | 1389   |
| Rubidium amalgams, solid, <i>see</i>  | –  | 4.3   | 3401   |
| Rubidium amide, <i>see</i>  | –  | 4.3   | 1390   |
| Rubidium dispersion, <i>see</i>   | –  | 4.3   | 1391   |

## Index

| Substance, material or article  | MP | Class | UN No. |
|---|----|-------|--------|
| Rubidium nitrate, <i>see</i>  | –  | 5.1   | 1477   |
| RUBIDIUM HYDROXIDE  | –  | 8     | 2678   |
| RUBIDIUM HYDROXIDE SOLUTION   | –  | 8     | 2677   |
| SAFETY DEVICES, electrically initiated  | –  | 9     | 3268   |
| SAFETY DEVICES, PYROTECHNIC   | –  | 1.4G  | 0503   |
| Salithion, <i>see</i> ORGANOPHOSPHORUS PESTICIDE  | P  | –     | –      |
| Saltpetre, <i>see</i>   | –  | 5.1   | 1486   |
| SAMPLES, EXPLOSIVE, other than initiating explosive   | –  | 1     | 0190   |
| Sand acid, <i>see</i>   | –  | 8     | 1778   |
| Schradan, <i>see</i> ORGANOPHOSPHORUS PESTICIDE   | –  | –     | –      |
| Seat-belt pretensioners, <i>see</i>   | –  | 1.4G  | 0503   |
| Seat-belt pretensioners, <i>see</i>   | –  | 9     | 3268   |
| SEED CAKE, containing vegetable oil<br>(a) mechanically expelled seeds, containing more than<br>10% of oil or more than 20% of oil and moisture combined  | –  | 4.2   | 1386   |
| SEED CAKE, containing vegetable oil<br>(b) solvent extractions and expelled seeds, containing not more<br>than 10% of oil and when the amount of moisture is higher than<br>10%, not more than 20% of oil and moisture combined | –  | 4.2   | 1386   |
| SEED CAKE with not more than 1.5% oil and not more than<br>11% moisture   | –  | 4.2   | 2217   |
| Seed expellers, oily, <i>see</i>  | –  | 4.2   | 1386   |
| SELENATES   | –  | 6.1   | 2630   |
| SELENIC ACID  | –  | 8     | 1905   |
| Seleninyl chloride, <i>see</i>  | –  | 8     | 2879   |
| SELENITES   | –  | 6.1   | 2630   |
| SELENIUM COMPOUND, LIQUID, N.O.S.   | –  | 6.1   | 3440   |
| SELENIUM COMPOUND, SOLID, N.O.S.  | –  | 6.1   | 3283   |
| SELENIUM DISULPHIDE   | –  | 6.1   | 2657   |
| SELENIUM HEXAFLUORIDE   | –  | 2.3   | 2194   |
| Selenium hydride, <i>see</i>  | –  | 2.3   | 2202   |
| SELENIUM OXYCHLORIDE  | –  | 8     | 2879   |
| SELF-HEATING LIQUID, CORROSIVE, INORGANIC, N.O.S.   | –  | 4.2   | 3188   |
| SELF-HEATING LIQUID, CORROSIVE, ORGANIC, N.O.S.   | –  | 4.2   | 3185   |
| SELF-HEATING LIQUID, INORGANIC, N.O.S.  | –  | 4.2   | 3186   |
| SELF-HEATING LIQUID, ORGANIC, N.O.S.  | –  | 4.2   | 3183   |
| SELF-HEATING LIQUID, TOXIC, INORGANIC, N.O.S.   | –  | 4.2   | 3187   |
| SELF-HEATING LIQUID, TOXIC, ORGANIC, N.O.S.   | –  | 4.2   | 3184   |
| SELF-HEATING SOLID, CORROSIVE, INORGANIC, N.O.S.  | –  | 4.2   | 3192   |
| SELF-HEATING SOLID, CORROSIVE, ORGANIC, N.O.S.  | –  | 4.2   | 3126   |
| SELF-HEATING SOLID, INORGANIC, N.O.S.   | –  | 4.2   | 3190   |
| SELF-HEATING SOLID, ORGANIC, N.O.S.   | –  | 4.2   | 3088   |
| SELF-HEATING SOLID, OXIDIZING, N.O.S.   | –  | 4.2   | 3127   |
| SELF-HEATING SOLID, TOXIC, INORGANIC, N.O.S.  | –  | 4.2   | 3191   |

| Substance, material or article   | MP | Class | UN No. |
|--|----|-------|--------|
| SELF-HEATING SOLID, TOXIC, ORGANIC, N.O.S.   | –  | 4.2   | 3128   |
| Self-reactive liquid, sample, <i>see</i>   | –  | 4.1   | 3223   |
| Self-reactive liquid, sample, temperature controlled, <i>see</i>                   | –  | 4.1   | 3233   |
| SELF-REACTIVE LIQUID TYPE B  | –  | 4.1   | 3221   |
| SELF-REACTIVE LIQUID TYPE B, TEMPERATURE CONTROLLED                                | –  | 4.1   | 3231   |
| SELF-REACTIVE LIQUID TYPE C  | –  | 4.1   | 3223   |
| SELF-REACTIVE LIQUID TYPE C, TEMPERATURE CONTROLLED                                | –  | 4.1   | 3233   |
| SELF-REACTIVE LIQUID TYPE D  | –  | 4.1   | 3225   |
| SELF-REACTIVE LIQUID TYPE D, TEMPERATURE CONTROLLED                                | –  | 4.1   | 3235   |
| SELF-REACTIVE LIQUID TYPE E  | –  | 4.1   | 3227   |
| SELF-REACTIVE LIQUID TYPE E, TEMPERATURE CONTROLLED                                | –  | 4.1   | 3237   |
| SELF-REACTIVE LIQUID TYPE F  | –  | 4.1   | 3229   |
| SELF-REACTIVE LIQUID TYPE F, TEMPERATURE CONTROLLED                                | –  | 4.1   | 3239   |
| Self-reactive solid, sample, <i>see</i>  | –  | 4.1   | 3224   |
| Self-reactive solid, sample, temperature controlled, <i>see</i>                    | –  | 4.1   | 3234   |
| SELF-REACTIVE SOLID TYPE B   | –  | 4.1   | 3222   |
| SELF-REACTIVE SOLID TYPE B, TEMPERATURE CONTROLLED                                 | –  | 4.1   | 3232   |
| SELF-REACTIVE SOLID TYPE C   | –  | 4.1   | 3224   |
| SELF-REACTIVE SOLID TYPE C, TEMPERATURE CONTROLLED                                 | –  | 4.1   | 3234   |
| SELF-REACTIVE SOLID TYPE D   | –  | 4.1   | 3226   |
| SELF-REACTIVE SOLID TYPE D, TEMPERATURE CONTROLLED                                 | –  | 4.1   | 3236   |
| SELF-REACTIVE SOLID TYPE E   | –  | 4.1   | 3228   |
| SELF-REACTIVE SOLID TYPE E, TEMPERATURE CONTROLLED                                 | –  | 4.1   | 3238   |
| SELF-REACTIVE SOLID TYPE F   | –  | 4.1   | 3230   |
| SELF-REACTIVE SOLID TYPE F, TEMPERATURE CONTROLLED                                 | –  | 4.1   | 3240   |
| SHALE OIL  | –  | 3     | 1288   |
| Shaped charges, <i>see</i> CHARGES, SHAPED   | –  | –     | –      |
| Shellac, <i>see</i> PAINT  | –  | –     | –      |
| SIGNAL DEVICES, HAND   | –  | 1.4G  | 0191   |
| SIGNAL DEVICES, HAND   | –  | 1.4S  | 0373   |
| SIGNALS, DISTRESS, ship  | –  | 1.1G  | 0194   |
| SIGNALS, DISTRESS, ship  | –  | 1.3G  | 0195   |
| SIGNALS, DISTRESS, ship  | –  | 1.4G  | 0505   |
| SIGNALS, DISTRESS, ship  | –  | 1.4S  | 0506   |
| Signals, distress, ship, water-activated, <i>see</i> CONTRIVANCES, WATER-ACTIVATED | –  | –     | –      |
| SIGNALS, RAILWAY TRACK, EXPLOSIVE  | –  | 1.1G  | 0192   |
| SIGNALS, RAILWAY TRACK, EXPLOSIVE  | –  | 1.3G  | 0492   |
| SIGNALS, RAILWAY TRACK, EXPLOSIVE  | –  | 1.4G  | 0493   |
| SIGNALS, RAILWAY TRACK, EXPLOSIVE  | –  | 1.4S  | 0193   |
| SIGNALS, SMOKE   | –  | 1.1G  | 0196   |
| SIGNALS, SMOKE   | –  | 1.2G  | 0313   |
| SIGNALS, SMOKE   | –  | 1.3G  | 0487   |

## Index

| Substance, material or article   | MP | Class | UN No. |
|--|----|-------|--------|
| SIGNALS, SMOKE   | –  | 1.4G  | 0197   |
| SIGNALS, SMOKE   | –  | 1.4S  | 0507   |
| Silafluofen, <i>see</i> Note 1   | P  | –     | –      |
| SILANE   | –  | 2.1   | 2203   |
| Silicofluoric acid, <i>see</i>   | –  | 8     | 1778   |
| Silicofluorides, n.o.s., <i>see</i>  | –  | 6.1   | 2856   |
| Silicon chloride, <i>see</i>   | –  | 8     | 1818   |
| SILICON POWDER, AMORPHOUS  | –  | 4.1   | 1346   |
| SILICON TETRACHLORIDE  | –  | 8     | 1818   |
| SILICON TETRAFLUORIDE  | –  | 2.3   | 1859   |
| SILICON TETRAFLUORIDE, ADSORBED  | –  | 2.3   | 3521   |
| Silicon tetrahydride, compressed, <i>see</i>   | –  | 2.1   | 2203   |
| SILVER ARSENITE  | P  | 6.1   | 1683   |
| SILVER CYANIDE   | P  | 6.1   | 1684   |
| SILVER NITRATE   | –  | 5.1   | 1493   |
| Silver orthoarsenite, <i>see</i>   | P  | 6.1   | 1683   |
| SILVER PICRATE, dry or wetted with less than 30% water, by mass<br>(transport prohibited)  | –  | –     | –      |
| SILVER PICRATE, WETTED with not less than 30% water, by mass   | –  | 4.1   | 1347   |
| Sisal, dry, <i>see</i>   | –  | 4.1   | 3360   |
| SLUDGE ACID  | –  | 8     | 1906   |
| Slurry, explosives, <i>see</i> EXPLOSIVES, BLASTING, TYPE E  | –  | –     | –      |
| Smokeless powder, <i>see</i>   | –  | 1.1C  | 0160   |
| SODA LIME with more than 4% sodium hydroxide   | –  | 8     | 1907   |
| SODIUM   | –  | 4.3   | 1428   |
| SODIUM ALUMINATE, SOLID  | –  | 8     | 2812   |
| SODIUM ALUMINATE SOLUTION  | –  | 8     | 1819   |
| SODIUM ALUMINIUM HYDRIDE   | –  | 4.3   | 2835   |
| Sodium amalgams, liquid, <i>see</i>  | –  | 4.3   | 1389   |
| Sodium amalgams, solid, <i>see</i>   | –  | 4.3   | 3401   |
| Sodium amide, <i>see</i>   | –  | 4.3   | 1390   |
| SODIUM AMMONIUM VANADATE   | –  | 6.1   | 2863   |
| SODIUM ARSANILATE  | –  | 6.1   | 2473   |
| SODIUM ARSENATE  | –  | 6.1   | 1685   |
| SODIUM ARSENITE, AQUEOUS SOLUTION  | –  | 6.1   | 1686   |
| Sodium arsenite (pesticide), <i>see</i> ARSENICAL PESTICIDE  | –  | –     | –      |
| SODIUM ARSENITE, SOLID   | –  | 6.1   | 2027   |
| SODIUM AZIDE   | –  | 6.1   | 1687   |
| Sodium bifluoride, <i>see</i>  | –  | 8     | 2439   |
| Sodium bisulphite solution, <i>see</i>   | –  | 8     | 2693   |
| SODIUM BOROHYDRIDE   | –  | 4.3   | 1426   |
| SODIUM BOROHYDRIDE AND SODIUM HYDROXIDE SOLUTION<br>with not more than 12% sodium borohydride and not more than<br>40% sodium hydroxide, by mass | –  | 8     | 3320   |

| Substance, material or article   | MP | Class | UN No. |
|--|----|-------|--------|
| SODIUM BROMATE   | –  | 5.1   | 1494   |
| SODIUM CACODYLATE  | –  | 6.1   | 1688   |
| SODIUM CARBONATE PEROXYHYDRATE   | –  | 5.1   | 3378   |
| SODIUM CHLORATE  | –  | 5.1   | 1495   |
| SODIUM CHLORATE, AQUEOUS SOLUTION  | –  | 5.1   | 2428   |
| Sodium chlorate mixed with dinitrotoluene, <i>see</i>                                    | –  | 1.1D  | 0083   |
| SODIUM CHLORITE  | –  | 5.1   | 1496   |
| SODIUM CHLOROACETATE   | –  | 6.1   | 2659   |
| Sodium copper cyanide, solid, <i>see</i>   | P  | 6.1   | 2316   |
| Sodium copper cyanide solution, <i>see</i>   | P  | 6.1   | 2317   |
| SODIUM CUPROCYANIDE, SOLID   | P  | 6.1   | 2316   |
| SODIUM CUPROCYANIDE SOLUTION   | P  | 6.1   | 2317   |
| SODIUM CYANIDE, SOLID  | P  | 6.1   | 1689   |
| SODIUM CYANIDE SOLUTION  | P  | 6.1   | 3414   |
| Sodium 2-diazo-1-naphthol-4-sulphonate (concentration 100%), <i>see</i>                  | –  | 4.1   | 3226   |
| Sodium 2-diazo-1-naphthol-5-sulphonate (concentration 100%), <i>see</i>                  | –  | 4.1   | 3226   |
| Sodium dicyanocuprate(I), solid, <i>see</i>  | P  | 6.1   | 2316   |
| Sodium dicyanocuprate(I) solution, <i>see</i>  | –  | 6.1   | 2317   |
| SODIUM DINITRO- <i>ortho</i> -CRESOLATE, dry or wetted with less than 15% water, by mass | P  | 1.3C  | 0234   |
| SODIUM DINITRO- <i>o</i> -CRESOLATE, WETTED with not less than 10% water, by mass        | P  | 4.1   | 3369   |
| SODIUM DINITRO- <i>o</i> -CRESOLATE, WETTED with not less than 15% water, by mass        | P  | 4.1   | 1348   |
| Sodium dioxide, <i>see</i>   | –  | 5.1   | 1504   |
| Sodium dispersion, <i>see</i>  | –  | 4.3   | 1391   |
| SODIUM DITHIONITE  | –  | 4.2   | 1384   |
| SODIUM FLUORIDE, SOLID   | –  | 6.1   | 1690   |
| SODIUM FLUORIDE SOLUTION   | –  | 6.1   | 3415   |
| SODIUM FLUOROACETATE   | –  | 6.1   | 2629   |
| SODIUM FLUOROSILICATE  | –  | 6.1   | 2674   |
| Sodium hexafluorosilicate, <i>see</i>  | –  | 6.1   | 2674   |
| Sodium hydrate, <i>see</i>   | –  | 8     | 1824   |
| SODIUM HYDRIDE   | –  | 4.3   | 1427   |
| Sodium hydrogen 4-aminophenylarsenate, <i>see</i>  | –  | 6.1   | 2473   |
| SODIUM HYDROGENDIFLUORIDE  | –  | 8     | 2439   |
| Sodium hydrogen sulphite solution, <i>see</i>  | –  | 8     | 2693   |
| SODIUM HYDROSULPHIDE with less than 25% water of crystallization                         | –  | 4.2   | 2318   |
| SODIUM HYDROSULPHIDE, HYDRATED with not less than 25% water of crystallization           | –  | 8     | 2949   |
| SODIUM HYDROSULPHITE   | –  | 4.2   | 1384   |
| SODIUM HYDROXIDE, SOLID  | –  | 8     | 1823   |
| SODIUM HYDROXIDE SOLUTION  | –  | 8     | 1824   |
| ■ SODIUM ION BATTERIES with organic electrolyte  | –  | 9     | 3551   |



## Index

|   | Substance, material or article   | MP | Class | UN No. |
|---|--|----|-------|--------|
| ■ | SODIUM ION BATTERIES CONTAINED IN EQUIPMENT,<br>with organic electrolyte | –  | 9     | 3552   |
| ■ | SODIUM ION BATTERIES PACKED WITH EQUIPMENT,<br>with organic electrolyte  | –  | 9     | 3552   |
|   | Sodium hypochlorite solution, <i>see</i>                                 | P  | 8     | 1791   |
|   | Sodium metaarsenite, <i>see</i>  | –  | 6.1   | 2027   |
|   | Sodium metasilicate, <i>see</i>  | –  | 8     | 3253   |
|   | Sodium metasilicate pentahydrate, <i>see</i>                             | –  | 8     | 3253   |
|   | Sodium methoxide, <i>see</i>   | –  | 4.2   | 1431   |
|   | Sodium methoxide solutions in alcohols, <i>see</i>                       | –  | 3     | 1289   |
|   | SODIUM METHYLATE   | –  | 4.2   | 1431   |
|   | SODIUM METHYLATE SOLUTION in alcohol                                     | –  | 3     | 1289   |
|   | Sodium monochloroacetate, <i>see</i>                                     | –  | 6.1   | 2659   |
|   | SODIUM MONOXIDE  | –  | 8     | 1825   |
|   | SODIUM NITRATE   | –  | 5.1   | 1498   |
|   | SODIUM NITRATE AND POTASSIUM NITRATE MIXTURE                             | –  | 5.1   | 1499   |
|   | SODIUM NITRITE   | –  | 5.1   | 1500   |
|   | Sodium nitrite and potassium nitrate mixture, <i>see</i>                 | –  | 5.1   | 1487   |
|   | Sodium orthoarsenate, <i>see</i>   | –  | 6.1   | 1685   |
|   | Sodium oxide, <i>see</i>   | –  | 8     | 1825   |
|   | SODIUM PENTACHLOROPHENATE  | P  | 6.1   | 2567   |
|   | Sodium perborate, anhydrous, <i>see</i>                                  | –  | 5.1   | 3247   |
|   | SODIUM PERBORATE MONOHYDRATE   | –  | 5.1   | 3377   |
|   | Sodium percarbonate, <i>see</i>  | –  | 5.1   | 3378   |
|   | SODIUM PERCHLORATE   | –  | 5.1   | 1502   |
|   | SODIUM PERMANGANATE  | –  | 5.1   | 1503   |
|   | SODIUM PEROXIDE  | –  | 5.1   | 1504   |
|   | SODIUM PEROXOBORATE, ANHYDROUS   | –  | 5.1   | 3247   |
|   | SODIUM PERSULPHATE   | –  | 5.1   | 1505   |
|   | SODIUM PHOSPHIDE   | –  | 4.3   | 1432   |
|   | SODIUM PICRAMATE, dry or wetted with less than 20% water, by<br>mass     | –  | 1.3C  | 0235   |
|   | SODIUM PICRAMATE, WETTED with not less than 20% water, by<br>mass        | –  | 4.1   | 1349   |
|   | Sodium potassium alloys, <i>see</i>                                      | –  | 4.3   | 1422   |
|   | Sodium silicofluoride, <i>see</i>  | –  | 6.1   | 2674   |
|   | SODIUM SULPHIDE, ANHYDROUS   | –  | 4.2   | 1385   |
|   | SODIUM SULPHIDE, HYDRATED with not less than 30% water                   | –  | 8     | 1849   |
|   | SODIUM SULPHIDE with less than 30% water of crystallization              | –  | 4.2   | 1385   |
|   | Sodium sulphhydrate, <i>see</i>  | –  | 4.2   | 2318   |
|   | SODIUM SUPEROXIDE  | –  | 5.1   | 2547   |
|   | SOLIDS CONTAINING CORROSIVE LIQUID, N.O.S.                               | –  | 8     | 3244   |
|   | SOLIDS CONTAINING FLAMMABLE LIQUID, N.O.S.                               | –  | 4.1   | 3175   |
|   | SOLIDS CONTAINING TOXIC LIQUID, N.O.S.                                   | –  | 6.1   | 3243   |

| Substance, material or article  | MP | Class | UN No. |
|---|----|-------|--------|
| Solvents, flammable, n.o.s., see  | –  | 3     | 1993   |
| Solvents, toxic, flammable, n.o.s., see   | –  | 3     | 1992   |
| SOUNDING DEVICES, EXPLOSIVE   | –  | 1.1D  | 0374   |
| SOUNDING DEVICES, EXPLOSIVE   | –  | 1.1F  | 0296   |
| SOUNDING DEVICES, EXPLOSIVE   | –  | 1.2D  | 0375   |
| SOUNDING DEVICES, EXPLOSIVE   | –  | 1.2F  | 0204   |
| Squibs, see IGNITERS, UN 0325 and UN 0454   | –  | –     | –      |
| Stain, see PAINT  | –  | –     | –      |
| STANNIC CHLORIDE, ANHYDROUS   | –  | 8     | 1827   |
| STANNIC CHLORIDE PENTAHYDRATE   | –  | 8     | 2440   |
| STANNIC PHOSPHIDE   | –  | 4.3   | 1433   |
| Steel swarf, see  | –  | 4.2   | 2793   |
| STIBINE   | –  | 2.3   | 2676   |
| STRAW   | –  | 4.1   | 1327   |
| Strontium alloy, non-pyrophoric, see  | –  | 4.3   | 1393   |
| Strontium alloy, pyrophoric, see  | –  | 4.2   | 1383   |
| Strontium amalgams, liquid, see   | –  | 4.3   | 1392   |
| Strontium amalgams, solid, see  | –  | 4.3   | 3402   |
| STRONTIUM ARSENITE  | –  | 6.1   | 1691   |
| STRONTIUM CHLORATE  | –  | 5.1   | 1506   |
| Strontium dioxide, see  | –  | 5.1   | 1509   |
| Strontium dispersion, see   | –  | 4.3   | 1391   |
| STRONTIUM NITRATE   | –  | 5.1   | 1507   |
| Strontium orthoarsenite, see  | –  | 6.1   | 1691   |
| STRONTIUM PERCHLORATE   | –  | 5.1   | 1508   |
| STRONTIUM PEROXIDE  | –  | 5.1   | 1509   |
| STRONTIUM PHOSPHIDE   | –  | 4.3   | 2013   |
| Strontium, powder, see  | –  | 4.2   | 1383   |
| Strontium powder, pyrophoric, see   | –  | 4.2   | 1383   |
| STRYCHNINE  | P  | 6.1   | 1692   |
| Strychnine pesticides, see PESTICIDE, N.O.S.  | P  | –     | –      |
| STRYCHNINE SALTS  | P  | 6.1   | 1692   |
| STYPHNIC ACID, dry or wetted with less than 20% water, or mixture of alcohol and water, by mass | –  | 1.1D  | 0219   |
| STYPHNIC ACID, WETTED with not less than 20% water, or mixture of alcohol and water, by mass    | –  | 1.1D  | 0394   |
| STYRENE MONOMER, STABILIZED   | –  | 3     | 2055   |
| SUBSTANCES, EVI, N.O.S.   | –  | 1.5D  | 0482   |
| SUBSTANCES, EXPLOSIVE, N.O.S.   | –  | 1.1A  | 0473   |
| SUBSTANCES, EXPLOSIVE, N.O.S.   | –  | 1.1C  | 0474   |
| SUBSTANCES, EXPLOSIVE, N.O.S.   | –  | 1.1D  | 0475   |
| SUBSTANCES, EXPLOSIVE, N.O.S.   | –  | 1.1G  | 0476   |
| SUBSTANCES, EXPLOSIVE, N.O.S.   | –  | 1.1L  | 0357   |
| SUBSTANCES, EXPLOSIVE, N.O.S.   | –  | 1.2L  | 0358   |

## Index

| Substance, material or article  | MP | Class | UN No. |
|---|----|-------|--------|
| SUBSTANCES, EXPLOSIVE, N.O.S.   | –  | 1.3C  | 0477   |
| SUBSTANCES, EXPLOSIVE, N.O.S.   | –  | 1.3G  | 0478   |
| SUBSTANCES, EXPLOSIVE, N.O.S.   | –  | 1.3L  | 0359   |
| SUBSTANCES, EXPLOSIVE, N.O.S.   | –  | 1.4C  | 0479   |
| SUBSTANCES, EXPLOSIVE, N.O.S.   | –  | 1.4D  | 0480   |
| SUBSTANCES, EXPLOSIVE, N.O.S.   | –  | 1.4G  | 0485   |
| SUBSTANCES, EXPLOSIVE, N.O.S.   | –  | 1.4S  | 0481   |
| SUBSTANCES, EXPLOSIVE, VERY INSENSITIVE, N.O.S.   | –  | 1.5D  | 0482   |
| SUBSTITUTED NITROPHENOL PESTICIDE, LIQUID, FLAMMABLE,<br>TOXIC, flashpoint less than 23°C     | –  | 3     | 2780   |
| SUBSTITUTED NITROPHENOL PESTICIDE, LIQUID, TOXIC  | –  | 6.1   | 3014   |
| SUBSTITUTED NITROPHENOL PESTICIDE, LIQUID, TOXIC,<br>FLAMMABLE, flashpoint not less than 23°C | –  | 6.1   | 3013   |
| SUBSTITUTED NITROPHENOL PESTICIDE, SOLID, TOXIC   | –  | 6.1   | 2779   |
| Sulfotep, <i>see</i> ORGANOPHOSPHORUS PESTICIDE   | P  | –     | –      |
| Sulfur, <i>see</i> Sulphur  | –  | –     | –      |
| SULPHAMIC ACID  | –  | 8     | 2967   |
| Sulphonyl chloride, <i>see</i>  | –  | 6.1   | 1834   |
| SULPHUR   | –  | 4.1   | 1350   |
| SULPHUR CHLORIDES   | –  | 8     | 1828   |
| Sulphur dichloride, <i>see</i>  | –  | 8     | 1828   |
| SULPHUR DIOXIDE   | –  | 2.3   | 1079   |
| Sulphuretted hydrogen, <i>see</i>   | –  | 2.3   | 1053   |
| SULPHUR HEXAFLUORIDE  | –  | 2.2   | 1080   |
| Sulphuric acid and hydrofluoric acid mixture, <i>see</i>                                      | –  | 8     | 1786   |
| SULPHURIC ACID, FUMING  | –  | 8     | 1831   |
| SULPHURIC ACID, SPENT   | –  | 8     | 1832   |
| SULPHURIC ACID with more than 51% acid  | –  | 8     | 1830   |
| SULPHURIC ACID with not more than 51% acid  | –  | 8     | 2796   |
| Sulphuric anhydride, stabilized, <i>see</i>   | –  | 8     | 1829   |
| Sulphuric chloride, <i>see</i>  | –  | 6.1   | 1834   |
| Sulphuric oxychloride, <i>see</i>   | –  | 6.1   | 1834   |
| Sulphuric oxyfluoride, <i>see</i>   | –  | 2.3   | 2191   |
| SULPHUR, MOLTEN   | –  | 4.1   | 2448   |
| Sulphur monochloride, <i>see</i>  | –  | 8     | 1828   |
| SULPHUROUS ACID   | –  | 8     | 1833   |
| Sulphurous oxychloride, <i>see</i>  | –  | 8     | 1836   |
| Sulphur oxychloride, <i>see</i>   | –  | 8     | 1836   |
| SULPHUR TETRAFLUORIDE   | –  | 2.3   | 2418   |
| SULPHUR TRIOXIDE, STABILIZED  | –  | 8     | 1829   |
| SULPHURYL CHLORIDE  | –  | 6.1   | 1834   |
| SULPHURYL FLUORIDE  | –  | 2.3   | 2191   |
| Sulprophos, <i>see</i> ORGANOPHOSPHORUS PESTICIDE   | P  | –     | –      |
| Synthetic fabrics, oily, <i>see</i>   | –  | 4.2   | 1373   |

| Substance, material or article                              | MP | Class | UN No. |
|---|----|-------|--------|
| Synthetic fibres, oily, <i>see</i>                          | –  | 4.2   | 1373   |
| Systox, <i>see</i> ORGANOPHOSPHORUS PESTICIDE               | –  | –     | –      |
| 2,4,5-T, <i>see</i> PHENOXYACETIC ACID DERIVATIVE PESTICIDE | –  | –     | –      |
| Table Tennis Balls, <i>see</i>                              | –  | 4.1   | 2000   |
| Talcum with tremolite and/or actinolite, <i>see</i>         | –  | 9     | 2212   |
| Tallow nitrile, <i>see</i>                                  | P  | 9     | 3082   |
| TARS, LIQUID, including road oils, and cutback bitumens     | –  | 3     | 1999   |
| Tartar emetic, <i>see</i>                                   | –  | 6.1   | 1551   |
| TEAR GAS CANDLES  | –  | 6.1   | 1700   |
| TEAR GAS SUBSTANCE, LIQUID, N.O.S.                          | –  | 6.1   | 1693   |
| TEAR GAS SUBSTANCE, SOLID, N.O.S.                           | –  | 6.1   | 3448   |
| TELLURIUM COMPOUND, N.O.S.                                  | –  | 6.1   | 3284   |
| TELLURIUM HEXAFLUORIDE                                      | –  | 2.3   | 2195   |
| Temphos, <i>see</i> ORGANOPHOSPHORUS PESTICIDE              | P  | –     | –      |
| TEPP, <i>see</i> ORGANOPHOSPHORUS PESTICIDE                 | P  | –     | –      |
| Terbufos, <i>see</i> ORGANOPHOSPHORUS PESTICIDE             | P  | –     | –      |
| Terbumeton, <i>see</i> TRIAZINE PESTICIDE                   | –  | –     | –      |
| TERPENE HYDROCARBONS, N.O.S.                                | –  | 3     | 2319   |
| Terpenes, n.o.s., <i>see</i>                                | –  | 3     | 2319   |
| TERPINOLENE   | –  | 3     | 2541   |
| TETRABROMOETHANE  | P  | 6.1   | 2504   |
| 1,1,2,2-Tetrabromoethane, <i>see</i>                        | P  | 6.1   | 2504   |
| Tetrabromomethane, <i>see</i>                               | P  | 6.1   | 2516   |
| 1,1,2,2-TETRACHLOROETHANE                                   | P  | 6.1   | 1702   |
| TETRACHLOROETHYLENE   | P  | 6.1   | 1897   |
| Tetrachloromethane, <i>see</i>                              | P  | 6.1   | 1846   |
| Tetrachlorophenol, <i>see</i>                               | –  | 6.1   | 2020   |
| Tetrachlorvinphos, <i>see</i> Note 1                        | P  | –     | –      |
| Tetraethoxysilane, <i>see</i>                               | –  | 3     | 1292   |
| TETRAETHYL DITHIOPYROPHOSPHATE                              | P  | 6.1   | 1704   |
| TETRAETHYLENEPENTAMINE                                      | –  | 8     | 2320   |
| Tetraethyllead, <i>see</i>                                  | P  | 6.1   | 1649   |
| Tetraethyl orthosilicate, <i>see</i>                        | –  | 3     | 1292   |
| TETRAETHYL SILICATE   | –  | 3     | 1292   |
| Tetrafluorodichloroethane, <i>see</i>                       | –  | 2.2   | 1958   |
| 1,1,2,2-Tetrafluoro-1,2-dichloroethane, <i>see</i>          | –  | 2.2   | 1958   |
| 1,1,1,2-TETRAFLUROETHANE                                    | –  | 2.2   | 3159   |
| TETRAFLUROETHYLENE, STABILIZED                              | –  | 2.1   | 1081   |
| TETRAFLUOROMETHANE  | –  | 2.2   | 1982   |
| Tetrafluorosilane, compressed, <i>see</i>                   | –  | 2.3   | 1859   |
| Tetrahydro-1,4-oxazine, <i>see</i>                          | –  | 8     | 2054   |
| 1,2,3,6-TETRAHYDROBENZALDEHYDE                              | –  | 3     | 2498   |

## Index

|   | Substance, material or article   | MP | Class | UN No. |
|---|--|----|-------|--------|
|   | Tetrahydrobenzene, <i>see</i>  | –  | 3     | 2256   |
|   | TETRAHYDROFURAN  | –  | 3     | 2056   |
|   | TETRAHYDROFURFURYLAMINE  | –  | 3     | 2943   |
|   | Tetrahydromethylfuran, <i>see</i>  | –  | 3     | 2536   |
|   | TETRAHYDROPHthalic ANHYDRIDES with more than 0.05% maleic anhydride  | –  | 8     | 2698   |
|   | 1,2,3,6-TETRAHYDROPYRIDINE   | –  | 3     | 2410   |
|   | TETRAHYDROTHIOPHENE  | –  | 3     | 2412   |
|   | Tetramethoxysilane, <i>see</i>   | –  | 6.1   | 2606   |
|   | Tetramethrin, <i>see</i> <b>Note 1</b>   | P  | –     | –      |
| △ | TETRAMETHYLAMMONIUM HYDROXIDE, SOLID   | –  | 6.1   | 3423   |
| △ | TETRAMETHYLAMMONIUM HYDROXIDE AQUEOUS SOLUTION with not less than 25% tetramethylammonium hydroxide, <i>see</i>                | –  | 6.1   | 3560   |
| △ | TETRAMETHYLAMMONIUM HYDROXIDE AQUEOUS SOLUTION with more than 2.5% but less than 25% tetramethylammonium hydroxide, <i>see</i> | –  | 8     | 1835   |
| △ | TETRAMETHYLAMMONIUM HYDROXIDE AQUEOUS SOLUTION with not more than 2.5% tetramethylammonium hydroxide, <i>see</i>               | –  | 8     | 1835   |
|   | 1,1,3,3-Tetramethylbutyl hydroperoxide (concentration ≤ 100%), <i>see</i>  | –  | 5.2   | 3105   |
|   | 1,1,3,3-Tetramethylbutyl peroxy-2-ethylhexanoate (concentration ≤ 100%), <i>see</i>  | –  | 5.2   | 3115   |
|   | 1,1,3,3-Tetramethylbutyl peroxyneodecanoate (concentration ≤ 52%, as a stable dispersion in water), <i>see</i>                 | –  | 5.2   | 3119   |
|   | 1,1,3,3-Tetramethylbutyl peroxyneodecanoate (concentration ≤ 72%, with diluent Type B), <i>see</i>                             | –  | 5.2   | 3115   |
|   | 1,1,3,3-Tetramethylbutyl peroxy-pivalate (concentration ≤ 77%, with diluent Type A), <i>see</i>                                | –  | 5.2   | 3115   |
|   | Tetramethylene, <i>see</i>   | –  | 2.1   | 2601   |
|   | Tetramethylene cyanide, <i>see</i>   | –  | 6.1   | 2205   |
|   | <i>N,N,N',N'</i> -Tetramethylethylenediamine, <i>see</i>   | –  | 3     | 2372   |
|   | Tetramethyl lead, <i>see</i>   | P  | 6.1   | 1649   |
|   | TETRAMETHYLSILANE  | –  | 3     | 2749   |
|   | Tetramine palladium(II) nitrate (concentration 100%), <i>see</i>   | –  | 4.1   | 3234   |
|   | TETRANITROANILINE  | –  | 1.1D  | 0207   |
|   | TETRANITROMETHANE  | –  | 6.1   | 1510   |
|   | Tetrapropylene, <i>see</i>   | P  | 3     | 2850   |
|   | TETRAPROPYL ORTHOTITANATE  | –  | 3     | 2413   |
|   | TETRAZENE, WETTED with not less than 30% water, or mixture of alcohol and water, by mass                                       | –  | 1.1A  | 0114   |
|   | TETRAZOL-1-ACETIC ACID   | –  | 1.4C  | 0407   |
|   | 1 <i>H</i> -TETRAZOLE  | –  | 1.1D  | 0504   |
|   | TETRYL   | –  | 1.1D  | 0208   |
|   | TEXTILE WASTE, WET   | –  | 4.2   | 1857   |
|   | THALLIUM CHLORATE  | P  | 5.1   | 2573   |
|   | Thallium(I) chlorate, <i>see</i>   | –  | 5.1   | 2573   |
|   | THALLIUM COMPOUND, N.O.S.  | P  | 6.1   | 1707   |

| Substance, material or article   | MP | Class | UN No. |
|--|----|-------|--------|
| THALLIUM NITRATE   | P  | 6.1   | 2727   |
| Thallium(I) nitrate, <i>see</i>  | –  | 6.1   | 2727   |
| Thallium sulphate, <i>see</i>  | P  | 6.1   | 1707   |
| Thallos chlorate, <i>see</i>   | P  | 5.1   | 2573   |
| 4-THIAPENTANAL   | –  | 6.1   | 2785   |
| Thia-4-pentanal, <i>see</i>  | –  | 6.1   | 2785   |
| THIOACETIC ACID  | –  | 3     | 2436   |
| Thioacetic acid, <i>see</i>  | –  | 3     | 2436   |
| THIOCARBAMATE PESTICIDE, LIQUID, FLAMMABLE, TOXIC,<br>flashpoint less than 23°C  | –  | 3     | 2772   |
| THIOCARBAMATE PESTICIDE, LIQUID, TOXIC   | –  | 6.1   | 3006   |
| THIOCARBAMATE PESTICIDE, LIQUID, TOXIC, FLAMMABLE,<br>flashpoint not less than 23°C  | –  | 6.1   | 3005   |
| THIOCARBAMATE PESTICIDE, SOLID, TOXIC  | –  | 6.1   | 2771   |
| Thiocarbonyl chloride, <i>see</i>  | –  | 6.1   | 2474   |
| Thiocarbonyl tetrachloride, <i>see</i>   | P  | 6.1   | 1670   |
| THIOGLYCOL   | –  | 6.1   | 2966   |
| THIOGLYCOLIC ACID  | –  | 8     | 1940   |
| THIOLACTIC ACID  | –  | 6.1   | 2936   |
| Thiometon, <i>see</i> ORGANOPHOSPHORUS PESTICIDE   | –  | –     | –      |
| Thionazin, <i>see</i> ORGANOPHOSPHORUS PESTICIDE   | –  | –     | –      |
| THIONYL CHLORIDE   | –  | 8     | 1836   |
| THIOPHENE  | –  | 3     | 2414   |
| Thiophenol, <i>see</i>   | –  | 6.1   | 2337   |
| THIOPHOSGENE   | –  | 6.1   | 2474   |
| THIOPHOSPHORYL CHLORIDE  | –  | 8     | 1837   |
| Thiopropyl alcohols, <i>see</i>  | –  | 3     | 2402   |
| THIOUREA DIOXIDE   | –  | 4.2   | 3341   |
| Tin chloride, fuming, <i>see</i>   | –  | 8     | 1827   |
| Tin(IV) chloride, anhydrous, <i>see</i>  | –  | 8     | 1827   |
| Tin(IV) chloride pentahydrate, <i>see</i>  | –  | 8     | 2440   |
| TINCTURES, MEDICINAL   | –  | 3     | 1293   |
| Tin monophosphide, <i>see</i>  | –  | 4.3   | 1433   |
| Tin tetrachloride, <i>see</i>  | –  | 8     | 1827   |
| Titanic chloride, <i>see</i>   | –  | 6.1   | 1838   |
| TITANIUM DISULPHIDE  | –  | 4.2   | 3174   |
| TITANIUM HYDRIDE   | –  | 4.1   | 1871   |
| TITANIUM POWDER, DRY   | –  | 4.2   | 2546   |
| TITANIUM POWDER, WETTED with not less than 25% water<br>(a visible excess of water must be present)<br>(a) mechanically produced, particle size less than 53 microns | –  | 4.1   | 1352   |
| TITANIUM POWDER, WETTED with not less than 25% water<br>(a visible excess of water must be present)<br>(b) chemically produced, particle size less than 840 microns  | –  | 4.1   | 1352   |
| TITANIUM SPONGE GRANULES   | –  | 4.1   | 2878   |



## Index

| Substance, material or article   | MP | Class | UN No. |
|--|----|-------|--------|
| TITANIUM SPONGE POWDERS  | –  | 4.1   | 2878   |
| TITANIUM TETRACHLORIDE   | –  | 6.1   | 1838   |
| TITANIUM TRICHLORIDE MIXTURE   | –  | 8     | 2869   |
| TITANIUM TRICHLORIDE MIXTURE, PYROPHORIC   | –  | 4.2   | 2441   |
| TITANIUM TRICHLORIDE, PYROPHORIC   | –  | 4.2   | 2441   |
| Titanous chloride, pyrophoric, <i>see</i>  | –  | 4.2   | 2441   |
| TNT AND HEXANITROSTILBENE MIXTURE  | –  | 1.1D  | 0388   |
| TNT AND TRINITROBENZENE MIXTURE  | –  | 1.1D  | 0388   |
| TNT, dry or wetted with less than 30% water, by mass   | –  | 1.1D  | 0209   |
| TNT mixed with aluminium, <i>see</i>   | –  | 1.1D  | 0390   |
| TNT MIXTURE CONTAINING TRINITROBENZENE AND HEXANITROSTILBENE   | –  | 1.1D  | 0389   |
| TNT, WETTED with not less than 10% water, by mass  | –  | 4.1   | 3366   |
| TNT, WETTED with not less than 30% water, by mass  | –  | 4.1   | 1356   |
| Toe puffs, nitrocellulose base, <i>see</i>   | –  | 4.1   | 1353   |
| TOLUENE  | –  | 3     | 1294   |
| TOLUENE DIISOCYANATE   | –  | 6.1   | 2078   |
| Toluene trichloride, <i>see</i>  | –  | 8     | 2226   |
| TOLUIDINES, LIQUID   | P  | 6.1   | 1708   |
| TOLUIDINES, SOLID  | P  | 6.1   | 3451   |
| Toluol, <i>see</i>   | –  | 3     | 1294   |
| 2,4-TOLUYLENEDIAMINE, SOLID  | –  | 6.1   | 1709   |
| 2,4-TOLUYLENEDIAMINE SOLUTION  | –  | 6.1   | 3418   |
| Tolylene diisocyanate, <i>see</i>  | –  | 6.1   | 2078   |
| Tolylene diisocyanate, <i>see</i>  | –  | 6.1   | 2078   |
| Tolyethylene, stabilized, <i>see</i>   | –  | 3     | 2618   |
| TORPEDOES, LIQUID FUELLED with inert head  | –  | 1.3J  | 0450   |
| TORPEDOES, LIQUID FUELLED with or without bursting charge  | –  | 1.1J  | 0449   |
| TORPEDOES with bursting charge   | –  | 1.1D  | 0451   |
| TORPEDOES with bursting charge   | –  | 1.1E  | 0329   |
| TORPEDOES with bursting charge   | –  | 1.1F  | 0330   |
| TOXIC BY INHALATION LIQUID, CORROSIVE, N.O.S. with an LC <sub>50</sub> lower than or equal to 200 mL/m <sup>3</sup> and saturated vapour concentration greater than or equal to 500 LC <sub>50</sub>             | –  | 6.1   | 3389   |
| TOXIC BY INHALATION LIQUID, CORROSIVE, N.O.S. with an LC <sub>50</sub> lower than or equal to 1,000 mL/m <sup>3</sup> and saturated vapour concentration greater than or equal to 10 LC <sub>50</sub>            | –  | 6.1   | 3390   |
| TOXIC BY INHALATION LIQUID, FLAMMABLE, CORROSIVE, N.O.S. with an LC <sub>50</sub> lower than or equal to 200 mL/m <sup>3</sup> and saturated vapour concentration greater than or equal to 500 LC <sub>50</sub>  | –  | 6.1   | 3488   |
| TOXIC BY INHALATION LIQUID, FLAMMABLE, CORROSIVE, N.O.S. with an LC <sub>50</sub> lower than or equal to 1,000 mL/m <sup>3</sup> and saturated vapour concentration greater than or equal to 10 LC <sub>50</sub> | –  | 6.1   | 3489   |
| TOXIC BY INHALATION LIQUID, FLAMMABLE, N.O.S. with an LC <sub>50</sub> lower than or equal to 1,000 mL/m <sup>3</sup> and saturated vapour concentration greater than or equal to 10 LC <sub>50</sub>            | –  | 6.1   | 3384   |

| Substance, material or article  | MP | Class | UN No. |
|---|----|-------|--------|
| TOXIC BY INHALATION LIQUID, FLAMMABLE, N.O.S. with an LC <sub>50</sub> lower than or equal to 200 mL/m <sup>3</sup> and saturated vapour concentration greater than or equal to 500 LC <sub>50</sub>                  | –  | 6.1   | 3383   |
| TOXIC BY INHALATION LIQUID, N.O.S. with an LC <sub>50</sub> lower than or equal to 1,000 mL/m <sup>3</sup> and saturated vapour concentration greater than or equal to 10 LC <sub>50</sub>                            | –  | 6.1   | 3382   |
| TOXIC BY INHALATION LIQUID, N.O.S. with an LC <sub>50</sub> lower than or equal to 200 mL/m <sup>3</sup> and saturated vapour concentration greater than or equal to 500 LC <sub>50</sub>                             | –  | 6.1   | 3381   |
| TOXIC BY INHALATION LIQUID, OXIDIZING, N.O.S. with an LC <sub>50</sub> lower than or equal to 1,000 mL/m <sup>3</sup> and saturated vapour concentration greater than or equal to 10 LC <sub>50</sub>                 | –  | 6.1   | 3388   |
| TOXIC BY INHALATION LIQUID, OXIDIZING, N.O.S. with an LC <sub>50</sub> lower than or equal to 200 mL/m <sup>3</sup> and saturated vapour concentration greater than or equal to 500 LC <sub>50</sub>                  | –  | 6.1   | 3387   |
| TOXIC BY INHALATION LIQUID, WATER-REACTIVE, FLAMMABLE, N.O.S. with an LC <sub>50</sub> lower than or equal to 200 mL/m <sup>3</sup> and saturated vapour concentration greater than or equal to 500 LC <sub>50</sub>  | –  | 6.1   | 3490   |
| TOXIC BY INHALATION LIQUID, WATER-REACTIVE, FLAMMABLE, N.O.S. with an LC <sub>50</sub> lower than or equal to 1,000 mL/m <sup>3</sup> and saturated vapour concentration greater than or equal to 10 LC <sub>50</sub> | –  | 6.1   | 3491   |
| TOXIC BY INHALATION LIQUID, WATER-REACTIVE, N.O.S. with an LC <sub>50</sub> lower than or equal to 1,000 mL/m <sup>3</sup> and saturated vapour concentration greater than or equal to 10 LC <sub>50</sub>            | –  | 6.1   | 3386   |
| TOXIC BY INHALATION LIQUID, WATER-REACTIVE, N.O.S. with an LC <sub>50</sub> lower than or equal to 200 mL/m <sup>3</sup> and saturated vapour concentration greater than or equal to 500 LC <sub>50</sub>             | –  | 6.1   | 3385   |
| TOXIC LIQUID, CORROSIVE, INORGANIC, N.O.S.  | –  | 6.1   | 3289   |
| TOXIC LIQUID, CORROSIVE, ORGANIC, N.O.S.  | –  | 6.1   | 2927   |
| TOXIC LIQUID, FLAMMABLE, ORGANIC, N.O.S.  | –  | 6.1   | 2929   |
| TOXIC LIQUID, INORGANIC, N.O.S.   | –  | 6.1   | 3287   |
| TOXIC LIQUID, ORGANIC, N.O.S.   | –  | 6.1   | 2810   |
| TOXIC LIQUID, OXIDIZING, N.O.S.   | –  | 6.1   | 3122   |
| TOXIC LIQUID, WATER-REACTIVE, N.O.S.  | –  | 6.1   | 3123   |
| TOXIC SOLID, CORROSIVE, INORGANIC, N.O.S.   | –  | 6.1   | 3290   |
| TOXIC SOLID, CORROSIVE, ORGANIC, N.O.S.   | –  | 6.1   | 2928   |
| TOXIC SOLID, FLAMMABLE, INORGANIC, N.O.S.   | –  | 6.1   | 3535   |
| TOXIC SOLID, FLAMMABLE, ORGANIC, N.O.S.   | –  | 6.1   | 2930   |
| TOXIC SOLID, INORGANIC, N.O.S.  | –  | 6.1   | 3288   |
| TOXIC SOLID, ORGANIC, N.O.S.  | –  | 6.1   | 2811   |
| TOXIC SOLID, OXIDIZING, N.O.S.  | –  | 6.1   | 3086   |
| TOXIC SOLID, SELF-HEATING, N.O.S.   | –  | 6.1   | 3124   |
| TOXIC SOLID, WATER-REACTIVE, N.O.S.   | –  | 6.1   | 3125   |
| TOXINS, EXTRACTED FROM LIVING SOURCES, LIQUID, N.O.S.   | –  | 6.1   | 3172   |
| TOXINS, EXTRACTED FROM LIVING SOURCES, SOLID, N.O.S.  | –  | 6.1   | 3462   |
| TRACERS FOR AMMUNITION  | –  | 1.3G  | 0212   |
| TRACERS FOR AMMUNITION  | –  | 1.4G  | 0306   |
| Tremolite, see  | –  | 9     | 2212   |

## Index

| Substance, material or article   | MP | Class | UN No. |
|--|----|-------|--------|
| Triadimefon, see PHENOXYACETIC ACID DERIVATIVE PESTICIDE                             | –  | –     | –      |
| TRIALLYLAMINE  | –  | 3     | 2610   |
| TRIALLYL BORATE  | –  | 6.1   | 2609   |
| Triamiphos, see ORGANOPHOSPHORUS PESTICIDE   | –  | –     | –      |
| Triaryl phosphates, isopropylated, see   | P  | 9     | 3082   |
| Triaryl phosphates, n.o.s., see  | P  | 9     | 3082   |
| TRIAZINE PESTICIDE, LIQUID, FLAMMABLE, TOXIC, flashpoint less than 23°C              | –  | 3     | 2764   |
| TRIAZINE PESTICIDE, LIQUID, TOXIC  | –  | 6.1   | 2998   |
| TRIAZINE PESTICIDE, LIQUID, TOXIC, FLAMMABLE, flashpoint not less than 23°C          | –  | 6.1   | 2997   |
| TRIAZINE PESTICIDE, SOLID, TOXIC   | –  | 6.1   | 2763   |
| Triazophos, see ORGANOPHOSPHORUS PESTICIDE   | P  | –     | –      |
| Tribromoborane, see  | –  | 8     | 2692   |
| Tribromomethane, see   | P  | 6.1   | 2515   |
| TRIBUTYLAMINE  | –  | 6.1   | 2542   |
| TRIBUTYLPHOSPHANE  | –  | 4.2   | 3254   |
| Tributyltin compounds, see ORGANOTIN PESTICIDE                                       | P  | –     | –      |
| Tricamba, see PESTICIDE, N.O.S.  | –  | –     | –      |
| Trichlorfon, see ORGANOPHOSPHORUS PESTICIDE  | P  | –     | –      |
| Trichloroacetaldehyde, see   | –  | 6.1   | 2075   |
| TRICHLOROACETIC ACID, SOLID  | –  | 8     | 1839   |
| TRICHLOROACETIC ACID SOLUTION  | –  | 8     | 2564   |
| Trichloroacetic aldehyde, anhydrous, stabilized, see                                 | –  | 6.1   | 2075   |
| TRICHLOROACETYL CHLORIDE   | –  | 8     | 2442   |
| 1,2,3-Trichlorobenzenes, see Note 1  | P  | –     | –      |
| TRICHLOROBENZENES, LIQUID  | P  | 6.1   | 2321   |
| TRICHLOROBUTENE  | P  | 6.1   | 2322   |
| Trichlorobutylene, see   | P  | 6.1   | 2322   |
| 1,1,1-TRICHLOROETHANE  | –  | 6.1   | 2831   |
| 1,1,2-Trichloroethane, see   | –  | 9     | 3082   |
| TRICHLOROETHYLENE  | –  | 6.1   | 1710   |
| TRICHLOROISOCYANURIC ACID, DRY   | –  | 5.1   | 2468   |
| Trichloromethane, see  | –  | 6.1   | 1888   |
| Trichloromethanesulphuryl chloride, see  | P  | 6.1   | 1670   |
| Trichloromethyl sulphochloride, see  | P  | 6.1   | 1670   |
| Trichloronat, see ORGANOPHOSPHORUS PESTICIDE   | P  | –     | –      |
| Trichloronitromethane, see   | –  | 6.1   | 1580   |
| TRICHLOROSILANE  | –  | 4.3   | 1295   |
| 2,4,6-Trichloro-1,3,5-triazine, see  | –  | 8     | 2670   |
| 1,3,5-Trichloro-s-triazine-2,4,6-trione, see   | –  | 5.1   | 2468   |
| Tricresyl phosphate, less than 1% <i>ortho</i> -isomer, see                          | P  | 9     | 3082   |
| Tricresyl phosphate, not less than 1% but not more than 3% <i>ortho</i> -isomer, see | P  | 9     | 3082   |

| Substance, material or article  | MP | Class | UN No. |
|---|----|-------|--------|
| TRICRESYL PHOSPHATE with more than 3% <i>ortho</i> -isomer  | P  | 6.1   | 2574   |
| Tricyanogen chloride, <i>see</i>  | –  | 8     | 2670   |
| Triethoxyboron, <i>see</i>  | –  | 3     | 1176   |
| Triethoxymethane, <i>see</i>  | –  | 3     | 2524   |
| TRIETHYLAMINE   | –  | 3     | 1296   |
| Triethylbenzene, <i>see</i>   | P  | 9     | 3082   |
| Triethyl borate, <i>see</i>   | –  | 3     | 1176   |
| Triethylenephosphoramidate solution, <i>see</i>   | –  | 6.1   | 2501   |
| TRIETHYLENETETRAMINE  | –  | 8     | 2259   |
| 3,6,9-Triethyl-3,6,9-trimethyl-1,4,7-triperoxonane<br>(concentration ≤ 17%, with diluent Type A, with inert solid)                              | –  | 5.2   | 3110   |
| Triethyl orthoformate, <i>see</i>   | –  | 3     | 2524   |
| TRIETHYL PHOSPHITE  | –  | 3     | 2323   |
| 3,6,9-Triethyl-3,6,9-trimethyl-1,4,7-triperoxonane (concentration<br>≤ 42%, with diluent Type A, available oxygen ≤ 7.6%), <i>see</i>           | –  | 5.2   | 3105   |
| TRIFLUOROACETIC ACID  | –  | 8     | 2699   |
| TRIFLUOROACETYL CHLORIDE  | –  | 2.3   | 3057   |
| Trifluorobromomethane, <i>see</i>   | –  | 2.2   | 1009   |
| Trifluorochloroethane, <i>see</i>   | –  | 2.2   | 1983   |
| TRIFLUOROCHLOROETHYLENE, STABILIZED<br>(REFRIGERANT GAS R 1113)   | –  | 2.3   | 1082   |
| Trifluorochloromethane, <i>see</i>  | –  | 2.2   | 1022   |
| 1,1,1-TRIFLUOROETHANE   | –  | 2.1   | 2035   |
| TRIFLUOROMETHANE  | –  | 2.2   | 1984   |
| Trifluoromethane and chlorotrifluoromethane azeotropic mixture,<br><i>see</i> CHLOROTRIFLUOROMETHANE AND TRIFLUOROMETHANE<br>AZEOTROPIC MIXTURE | –  | –     | –      |
| TRIFLUOROMETHANE, REFRIGERATED LIQUID   | –  | 2.2   | 3136   |
| Trifluoromethoxytrifluoroethylene, <i>see</i>   | –  | 2.1   | 3153   |
| 2-TRIFLUOROMETHYLANILINE  | –  | 6.1   | 2942   |
| 3-TRIFLUOROMETHYLANILINE  | –  | 6.1   | 2948   |
| Trifluoromethylbenzene, <i>see</i>  | –  | 3     | 2338   |
| Trifluoromethylphenyl isocyanates, <i>see</i>   | –  | 6.1   | 2285   |
| ■ TRIFLUOROMETHYLTETRAZOLE-SODIUM SALT IN ACETONE,<br>with not less than 68% acetone, by mass   | –  | 3     | 3555   |
| Trifluoromethyl trifluorovinyl ether, <i>see</i>  | –  | 2.1   | 3153   |
| Trifluoromonochloroethylene, stabilized, <i>see</i>   | –  | 2.3   | 1082   |
| TRIISOBUTYLENE  | –  | 3     | 2324   |
| Triisopropylated phenyl phosphates, <i>see</i>  | P  | 9     | 3077   |
| TRIISOPROPYL BORATE   | –  | 3     | 2616   |
| TRIMETHYLACETYL CHLORIDE  | –  | 6.1   | 2438   |
| TRIMETHYLAMINE, ANHYDROUS   | –  | 2.1   | 1083   |
| TRIMETHYLAMINE, AQUEOUS SOLUTION, not more than<br>50% trimethylamine, by mass  | –  | 3     | 1297   |
| 1,3,5-TRIMETHYLBENZENE  | P  | 3     | 2325   |

## Index

| Substance, material or article   | MP | Class | UN No. |
|--|----|-------|--------|
| TRIMETHYL BORATE   | –  | 3     | 2416   |
| Trimethyl carbinol, <i>see</i>   | –  | 3     | 1120   |
| TRIMETHYLCHLOROSILANE  | –  | 3     | 1298   |
| TRIMETHYLCYCLOHEXYLAMINE   | –  | 8     | 2326   |
| Trimethylene chlorobromide, <i>see</i>   | –  | 6.1   | 2688   |
| Trimethylene chlorohydrin, <i>see</i>  | –  | 6.1   | 2849   |
| Trimethylene dichloride, <i>see</i>  | –  | 3     | 1993   |
| Trimethylgallium, <i>see</i>   | –  | 4.2   | 3394   |
| TRIMETHYLHEXAMETHYLENEDIAMINES   | –  | 8     | 2327   |
| TRIMETHYLHEXAMETHYLENE DIISOCYANATE  | –  | 6.1   | 2328   |
| 2,2,4-Trimethylpentane, <i>see</i>   | P  | 3     | 1262   |
| 2,4,4-Trimethylpentene-1, <i>see</i>   | –  | 3     | 2050   |
| 2,4,4-Trimethylpentene-2, <i>see</i>   | –  | 3     | 2050   |
| TRIMETHYL PHOSPHITE  | –  | 3     | 2329   |
| 2,4,6-Trimethyl-1,3,5-trioxane, <i>see</i>   | –  | 3     | 1264   |
| TRINITROANILINE  | –  | 1.1D  | 0153   |
| TRINITROANISOLE  | –  | 1.1D  | 0213   |
| TRINITROBENZENE, dry or wetted with less than 30% water, by mass                                     | –  | 1.1D  | 0214   |
| TRINITROBENZENESULPHONIC ACID  | –  | 1.1D  | 0386   |
| TRINITROBENZENE, WETTED with not less than 10% water, by mass  | –  | 4.1   | 3367   |
| TRINITROBENZENE, WETTED with not less than 30% water, by mass  | –  | 4.1   | 1354   |
| TRINITROBENZOIC ACID, dry or wetted with less than 30% water, by mass                                | –  | 1.1D  | 0215   |
| TRINITROBENZOIC ACID, WETTED with not less than 10% water, by mass                                   | –  | 4.1   | 3368   |
| TRINITROBENZOIC ACID, WETTED with not less than 30% water, by mass                                   | –  | 4.1   | 1355   |
| TRINITROCHLORO BENZENE   | –  | 1.1D  | 0155   |
| TRINITROCHLORO BENZENE, WETTED with not less than 10% water, by mass                                 | –  | 4.1   | 3365   |
| TRINITRO- <i>m</i> -CRESOL   | –  | 1.1D  | 0216   |
| TRINITROFLUORENONE   | –  | 1.1D  | 0387   |
| TRINITRONAPHTHALENE  | –  | 1.1D  | 0217   |
| TRINITROPHENETOLE  | –  | 1.1D  | 0218   |
| TRINITROPHENOL, dry or wetted with less than 30% water, by mass                                      | –  | 1.1D  | 0154   |
| TRINITROPHENOL, WETTED with not less than 10% water, by mass   | –  | 4.1   | 3364   |
| TRINITROPHENOL, WETTED with not less than 30% water, by mass   | –  | 4.1   | 1344   |
| TRINITROPHENYLMETHYLNITRAMINE  | –  | 1.1D  | 0208   |
| TRINITRORESORCINOL, dry or wetted with less than 20% water, or mixture of alcohol and water, by mass | –  | 1.1D  | 0219   |
| TRINITRORESORCINOL, WETTED with not less than 20% water, or mixture of alcohol and water, by mass    | –  | 1.1D  | 0394   |
| TRINITROTOLUENE AND HEXANITROSTILBENE MIXTURE  | –  | 1.1D  | 0388   |
| TRINITROTOLUENE AND TRINITROBENZENE MIXTURE  | –  | 1.1D  | 0388   |
| TRINITROTOLUENE, dry or wetted with less than 30% water, by mass                                     | –  | 1.1D  | 0209   |

| Substance, material or article  | MP | Class | UN No. |
|---|----|-------|--------|
| TRINITROTOLUENE MIXTURE CONTAINING TRINITROBENZENE AND HEXANITROSTILBENE  | –  | 1.1D  | 0389   |
| TRINITROTOLUENE, WETTED with not less than 10% water, by mass   | –  | 4.1   | 3366   |
| TRINITROTOLUENE, WETTED with not less than 30% water, by mass   | –  | 4.1   | 1356   |
| Trinitrotoluol, wetted with not less than 10% water by mass, see  | –  | 4.1   | 3366   |
| Trinitrotoluol, wetted with not less than 30% water by mass, see  | –  | 4.1   | 1356   |
| Triphenyl phosphate, see  | P  | 9     | 3077   |
| Triphenyl phosphate/ <i>tert</i> -butylated triphenyl phosphates mixtures containing 5% to 10% of triphenyl phosphate, see <b>Note 1</b>  | P  | –     | –      |
| Triphenyl phosphate/ <i>tert</i> -butylated triphenyl phosphates mixtures containing 10% to 48% of triphenyl phosphate, see <b>Note 1</b> | P  | –     | –      |
| Triphenyltin compounds (other than Fentin acetate and Fentin hydroxide), see ORGANOTIN PESTICIDE  | P  | –     | –      |
| TRIPROPYLAMINE  | –  | 3     | 2260   |
| TRIPROPYLENE  | P  | 3     | 2057   |
| TRIS-(1-AZIRIDINYL)PHOSPHINE OXIDE SOLUTION   | –  | 6.1   | 2501   |
| Tritolyl phosphate, see   | P  | 6.1   | 2574   |
| TRITONAL  | –  | 1.1D  | 0390   |
| Trixylenyl phosphate, see   | P  | 9     | 3082   |
| Tropilidene, see  | –  | 3     | 2603   |
| TUNGSTEN HEXAFLUORIDE   | –  | 2.3   | 2196   |
| TURPENTINE  | P  | 3     | 1299   |
| TURPENTINE SUBSTITUTE   | –  | 3     | 1300   |
| UNDECANE  | –  | 3     | 2330   |
| Uranium hexafluoride, fissile, see  | –  | 7     | 2977   |
| Uranium hexafluoride, non fissile or fissile-excepted, see  | –  | 7     | 2978   |
| URANIUM HEXAFLUORIDE, RADIOACTIVE MATERIAL, EXCEPTED PACKAGE, less than 0.1 kg per package, non-fissile or fissile-excepted               | –  | 6.1   | 3507   |
| UREA HYDROGEN PEROXIDE  | –  | 5.1   | 1511   |
| UREA NITRATE, dry or wetted, with less than 20% water, by mass  | –  | 1.1D  | 0220   |
| UREA NITRATE, WETTED with not less than 10% water, by mass  | –  | 4.1   | 3370   |
| UREA NITRATE, WETTED with not less than 20% water, by mass  | –  | 4.1   | 1357   |
| Urotropine, see   | –  | 4.1   | 1328   |
| Valeral, see  | –  | 3     | 2058   |
| VALERALDEHYDE   | –  | 3     | 2058   |
| Valeric aldehyde(s), see  | –  | 3     | 2058   |
| VALERYL CHLORIDE  | –  | 8     | 2502   |
| Vamidothion, see ORGANOPHOSPHORUS PESTICIDE   | –  | –     | –      |
| VANADIUM COMPOUND, N.O.S.   | –  | 6.1   | 3285   |
| Vanadium(IV) oxide sulphate   | –  | 6.1   | 2931   |
| Vanadium oxysulphate, see   | –  | 6.1   | 2931   |
| VANADIUM OXYTRICHLORIDE   | –  | 8     | 2443   |



## Index

| Substance, material or article                             | MP | Class | UN No. |
|--|----|-------|--------|
| VANADIUM PENTOXIDE, non-fused form                         | –  | 6.1   | 2862   |
| VANADIUM TETRACHLORIDE                                     | –  | 8     | 2444   |
| VANADIUM TRICHLORIDE                                       | –  | 8     | 2475   |
| VANADYL SULPHATE   | –  | 6.1   | 2931   |
| Varnish, see PAINT   | –  | –     | –      |
| Vegetable fabrics, oily, see                               | –  | 4.2   | 1373   |
| Vegetable fibres, burnt, see                               | –  | 4.2   | 1372   |
| Vegetable fibres, damp, see                                | –  | 4.2   | 1372   |
| Vegetable fibres, dry, see                                 | –  | 4.1   | 3360   |
| Vegetable fibres, oily, see                                | –  | 4.2   | 1373   |
| Vegetable fibres, wet, see                                 | –  | 4.2   | 1372   |
| VEHICLE, FLAMMABLE GAS POWERED                             | –  | 9     | 3166   |
| VEHICLE, FLAMMABLE LIQUID POWERED                          | –  | 9     | 3166   |
| VEHICLE, FUEL CELL, FLAMMABLE GAS POWERED                  | –  | 9     | 3166   |
| VEHICLE, FUEL CELL, FLAMMABLE LIQUID POWERED               | –  | 9     | 3166   |
| ■ VEHICLE, LITHIUM ION BATTERY POWERED                     | –  | 9     | 3556   |
| ■ VEHICLE, LITHIUM METAL BATTERY POWERED                   | –  | 9     | 3557   |
| ■ VEHICLE, SODIUM ION BATTERY POWERED                      | –  | 9     | 3558   |
| VINYL ACETATE, STABILIZED                                  | –  | 3     | 1301   |
| Vinylbenzene, stabilized, see                              | –  | 3     | 2055   |
| VINYL BROMIDE, STABILIZED                                  | –  | 2.1   | 1085   |
| Vinyl <i>normal</i> -butyl ether, stabilized, see          | –  | 3     | 2352   |
| VINYL BUTYRATE, STABILIZED                                 | –  | 3     | 2838   |
| VINYL CHLORIDE, STABILIZED                                 | –  | 2.1   | 1086   |
| VINYL CHLOROACETATE  | –  | 6.1   | 2589   |
| Vinyl cyanide, stabilized, see                             | –  | 3     | 1093   |
| Vinyl ether, stabilized, see                               | –  | 3     | 1167   |
| VINYL ETHYL ETHER, STABILIZED                              | –  | 3     | 1302   |
| VINYL FLUORIDE, STABILIZED                                 | –  | 2.1   | 1860   |
| VINYLDENE CHLORIDE, STABILIZED                             | P  | 3     | 1303   |
| Vinylidene fluoride, see                                   | –  | 2.1   | 1959   |
| VINYL ISOBUTYL ETHER, STABILIZED                           | –  | 3     | 1304   |
| VINYL METHYL ETHER, STABILIZED                             | –  | 2.1   | 1087   |
| VINYLPYRIDINES, STABILIZED                                 | –  | 6.1   | 3073   |
| VINYLTOLUENES, STABILIZED                                  | –  | 3     | 2618   |
| VINYLTRICHLOROSILANE                                       | –  | 3     | 1305   |
| Warfarin (and salts of), see COUMARIN DERIVATIVE PESTICIDE | P  | –     | –      |
| Warheads for guided missiles, see WARHEADS, ROCKET         | –  | –     | –      |
| WARHEADS, ROCKET with burster or expelling charge          | –  | 1.4D  | 0370   |
| WARHEADS, ROCKET with burster or expelling charge          | –  | 1.4F  | 0371   |
| WARHEADS, ROCKET with bursting charge                      | –  | 1.1D  | 0286   |
| WARHEADS, ROCKET with bursting charge                      | –  | 1.1F  | 0369   |

| Substance, material or article  | MP | Class | UN No. |
|---|----|-------|--------|
| WARHEADS, ROCKET with bursting charge                                     | –  | 1.2D  | 0287   |
| WARHEADS, TORPEDO with bursting charge                                    | –  | 1.1D  | 0221   |
| Water-activated contrivances, <i>see</i> CONTRIVANCES,<br>WATER-ACTIVATED | –  | –     | –      |
| Water gels, <i>see</i> EXPLOSIVE, BLASTING, TYPE E                        | –  | –     | –      |
| WATER-REACTIVE LIQUID, CORROSIVE, N.O.S.                                  | –  | 4.3   | 3129   |
| WATER-REACTIVE LIQUID, N.O.S.   | –  | 4.3   | 3148   |
| WATER-REACTIVE LIQUID, TOXIC, N.O.S.                                      | –  | 4.3   | 3130   |
| WATER-REACTIVE SOLID, CORROSIVE, N.O.S.                                   | –  | 4.3   | 3131   |
| WATER-REACTIVE SOLID, FLAMMABLE, N.O.S.                                   | –  | 4.3   | 3132   |
| WATER-REACTIVE SOLID, N.O.S.  | –  | 4.3   | 2813   |
| WATER-REACTIVE SOLID, OXIDIZING, N.O.S.                                   | –  | 4.3   | 3133   |
| WATER-REACTIVE SOLID, SELF-HEATING, N.O.S.                                | –  | 4.3   | 3135   |
| WATER-REACTIVE SOLID, TOXIC, N.O.S.                                       | –  | 4.3   | 3134   |
| White arsenic, <i>see</i>   | –  | 6.1   | 1561   |
| White phosphorus, dry, <i>see</i>   | P  | 4.2   | 1381   |
| White phosphorus, wet, <i>see</i>   | P  | 4.2   | 1381   |
| White spirit, <i>see</i>  | P  | 3     | 1300   |
| White spirit, low (15–20%) aromatic, <i>see</i>                           | P  | 3     | 1300   |
| WOOD PRESERVATIVES, LIQUID  | –  | 3     | 1306   |
| Wood tar, <i>see</i>  | P  | 9     | 3082   |
| WOOL WASTE, WET   | –  | 4.2   | 1387   |
| XANTHATES   | –  | 4.2   | 3342   |
| XENON   | –  | 2.2   | 2036   |
| XENON, REFRIGERATED LIQUID  | –  | 2.2   | 2591   |
| XYLENES   | –  | 3     | 1307   |
| XYLENOLS, LIQUID  | –  | 6.1   | 3430   |
| XYLENOLS, SOLID   | –  | 6.1   | 2261   |
| XYLIDINES, LIQUID   | –  | 6.1   | 1711   |
| XYLIDINES, SOLID  | –  | 6.1   | 3452   |
| Xylols, <i>see</i>  | –  | 3     | 1307   |
| XYLYL BROMIDE, LIQUID   | –  | 6.1   | 1701   |
| XYLYL BROMIDE, SOLID  | –  | 6.1   | 3417   |
| Yellow phosphorus, dry, <i>see</i>  | P  | 4.2   | 1381   |
| Yellow phosphorus, wet, <i>see</i>  | P  | 4.2   | 1381   |
| ZINC AMMONIUM NITRITE ( <b>transport prohibited</b> )                     | –  | 5.1   | 1512   |
| ZINC ARSENATE   | –  | 6.1   | 1712   |
| ZINC ARSENATE AND ZINC ARSENITE MIXTURE                                   | –  | 6.1   | 1712   |
| ZINC ARSENITE   | –  | 6.1   | 1712   |
| ZINC ASHES  | –  | 4.3   | 1435   |
| Zinc bisulphite solution, <i>see</i>                                      | –  | 8     | 2693   |

## Index

| Substance, material or article  | MP | Class | UN No. |
|---|----|-------|--------|
| ZINC BROMATE  | –  | 5.1   | 2469   |
| Zinc bromide, <i>see</i>  | P  | 9     | 3077   |
| ZINC CHLORATE   | –  | 5.1   | 1513   |
| ZINC CHLORIDE, ANHYDROUS  | P  | 8     | 2331   |
| ZINC CHLORIDE SOLUTION  | P  | 8     | 1840   |
| ZINC CYANIDE  | P  | 6.1   | 1713   |
| ZINC DITHIONITE   | –  | 9     | 1931   |
| ZINC DUST   | –  | 4.3   | 1436   |
| Zinc dust, pyrophoric, <i>see</i>   | –  | 4.2   | 1383   |
| ZINC FLUOROSILICATE   | –  | 6.1   | 2855   |
| Zinc hexafluorosilicate, <i>see</i>   | –  | 6.1   | 2855   |
| ZINC HYDROSULPHITE  | –  | 9     | 1931   |
| ZINC NITRATE  | –  | 5.1   | 1514   |
| ZINC PERMANGANATE   | –  | 5.1   | 1515   |
| ZINC PEROXIDE   | –  | 5.1   | 1516   |
| ZINC PHOSPHIDE  | –  | 4.3   | 1714   |
| ZINC POWDER   | –  | 4.3   | 1436   |
| Zinc powder, pyrophoric, <i>see</i>   | –  | 4.2   | 1383   |
| ZINC RESINATE   | –  | 4.1   | 2714   |
| Zinc silicofluoride, <i>see</i>   | –  | 6.1   | 2855   |
| ZIRCONIUM, DRY, coiled wire, finished metal sheets, strip<br>(thinner than 254 microns but not thinner than 18 microns)   | –  | 4.1   | 2858   |
| ZIRCONIUM, DRY, finished sheets, strip or coiled wire   | –  | 4.2   | 2009   |
| ZIRCONIUM HYDRIDE   | –  | 4.1   | 1437   |
| ZIRCONIUM NITRATE   | –  | 5.1   | 2728   |
| ZIRCONIUM PICRAMATE, dry or wetted with less than 20% water,<br>by mass   | –  | 1.3C  | 0236   |
| ZIRCONIUM PICRAMATE, WETTED with not less than 20% water,<br>by mass  | –  | 4.1   | 1517   |
| ZIRCONIUM POWDER, DRY   | –  | 4.2   | 2008   |
| ZIRCONIUM POWDER, WETTED with not less than 25% water<br>(a visible excess of water must be present)<br>(a) mechanically produced, particle size less than 53 microns | –  | 4.1   | 1358   |
| ZIRCONIUM POWDER, WETTED with not less than 25% water<br>(a visible excess of water must be present)<br>(b) chemically produced, particle size less than 840 microns  | –  | 4.1   | 1358   |
| ZIRCONIUM SCRAP   | –  | 4.2   | 1932   |
| ZIRCONIUM, SUSPENDED IN A FLAMMABLE LIQUID  | –  | 3     | 1308   |
| ZIRCONIUM TETRACHLORIDE   | –  | 8     | 2503   |